



SLS AMG

Operator's Manual



Mercedes-Benz

Symbols

Registered trademarks:

- Bluetooth® is a registered trademark of Bluetooth SIG Inc.
- DTS is a registered trademark of DTS, Inc.
- Dolby and MLP are registered trademarks of DOLBY Laboratories.
- BabySmart™, ESP® and PRE-SAFE® are registered trademarks of Daimler AG.
- HomeLink® is a registered trademark of Prince.
- iPod® and iTunes® are registered trademarks of Apple Inc.
- Logic 7® is a registered trademark of Harman International Industries.
- Microsoft® and Windows media® are registered trademarks of Microsoft Corporation.
- SIRIUS is a registered trademark of Sirius XM radio Inc.
- HD Radio is a registered trademark of iBiquity Digital Corporation.
- Gracenote® is a registered trademark of Gracenote, Inc.
- ZAGATSurvey® and related brands are registered trademarks of ZagatSurvey, LLC.

In this Operator's Manual, you will find the following symbols:

WARNING

Warning notes draw your attention to hazards that endanger your health or life, or the health or life of others.

 Notes on material damage alert you to dangers that could lead to damage to your vehicle.

 This symbol indicates useful instructions or further information that could be helpful to you.

- ▶ This symbol designates an instruction you must follow.
- ▶ Several consecutive symbols indicate an instruction with several steps.

(▷ page) This symbol tells you where you can find further information on a topic.

▷▷ This symbol indicates a warning or an instruction that is continued on the next page.

Display This font indicates a display message in the multifunction display/COMAND display.

Parts of the software in the vehicle are protected by copyright © 2005 The FreeType Project <http://www.freetype.org>. All rights reserved.

Welcome to the world of Mercedes-Benz

Before you drive off, please familiarize yourself with your vehicle and read this manual, especially the safety and warning notes. This will help you to obtain the maximum pleasure from your vehicle and avoid endangering yourself and others.

The equipment or model designation of your vehicle may differ according to:

- model
- order
- country variant
- availability

Mercedes-Benz is constantly updating its vehicles to the state of the art.

Mercedes-Benz therefore reserves the right to introduce changes in the following areas:

- design
- equipment
- technical features

Therefore, you cannot base any claims on the illustrations or text content in this Operator's Manual.

The following are integral components of the vehicle:

- Operator's Manual
- Maintenance Booklet
- Equipment-dependent supplements

Keep these documents in the vehicle at all times. When you sell the vehicle, always pass the documents on to the new owner.

The technical documentation team at Daimler AG wishes you safe and pleasant motoring.

Mercedes-Benz USA, LLC

Mercedes-Benz Canada, Inc.

A Daimler Company

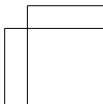
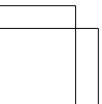
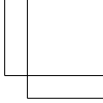
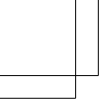

Index	4	At a glance	25
Introduction	18	Safety	35
		Opening/closing	63
		Seats, steering wheel and mirrors	83
		Lights and windshield wipers	93
		Climate control	103
		Driving and parking	113
		On-board computer and displays	147
		Stowage and features	199
		Maintenance and care	217
		Breakdown assistance	231
		Tires and wheels	249
		Technical data	275

1, 2, 3 ...

12 V socket

see Sockets

A**ABS (Anti-lock Braking System)**

Function/notes 55

Warning lamp 192

Activating/deactivating cooling**with air dehumidification** 106**ADAPTIVE BRAKE** 59**Additional speedometer** 157**Additives (engine oil)** 282**Adjusting lumbar support** 86**Air bags**

Display message 171

Front air bag (driver, front
passenger) 39

Important safety notes 38

Knee bag 40

PASSENGER AIR BAG OFF

indicator lamp 42

Safety guidelines 37

Side impact air bag 40

Air-conditioning system

see Climate control

Air filter (display message) 180**Air pressure**

see Tire pressure

AIRSCARF

Setting the vents 111

Switching on/off 87

Air vents

Important safety notes 110

Setting 110

Setting the AIRSCARF vents 111

Setting the center air vents 110

Setting the side air vents 110

Switching AIRSCARF on/off 87

Alarm system

see ATA (Anti-Theft Alarm system)

AMGAdaptive sport suspension
system 138

Button for AMG menu 126

E-SELECT lever 119

Menu (on-board computer) 160

SETUP 126

SPEEDSHIFT DCT 7-gear sport

transmission 119

Anti-lock Braking System

see ABS (Anti-lock Braking System)

Anti-Theft Alarm system

see ATA (Anti-Theft Alarm system)

Ashtray 203**ASSYST PLUS service interval****display**

Hiding service messages 222

Service messages 222

ATA (Anti-Theft Alarm system)

Activating/deactivating 59

Function 59

Switching off the alarm 59

Audio menu (on-board computer) 154**Audio system**

see separate operating instructions

Authorized Mercedes-Benz Center

see Qualified specialist workshop

Authorized workshop

see Qualified specialist workshop

AUTO lights

Display message 174

Automatic headlamp mode 95**B****Back support**

see Lumbar support

Backup lamp

Display message 175

BAS (Brake Assist System) 55**Basic settings**

see Settings

Battery

Display message 185

Battery (SmartKey)

Checking 66

Important safety notes 65

Replacing 66

Battery (vehicle)

Charging 242

Display message 178

Important safety notes 240

- Jump starting 243
 - Location 242
 - Belt**
 - see Seat belts
 - Blind Spot Assist**
 - Activating/deactivating 156
 - Display message 181
 - Notes/function 143
 - Brake Assist System**
 - see BAS (Brake Assist System)
 - Brake fluid**
 - Display message 169
 - Notes 282
 - Brake lamps**
 - Display message 174
 - Brakes**
 - ABS 55
 - BAS 55
 - Brake fluid (notes) 282
 - Display message 165
 - Driving tips 133
 - High-performance brake system 134
 - Important safety notes 133
 - Maintenance 134
 - Warning lamp 190, 192
 - Breakdown**
 - see Flat tire
 - see Towing away/tow-starting
 - Bulbs**
 - see Changing bulbs
- C**
- California**
 - Important notice for retail customers and lessees 19
 - Calling up a malfunction**
 - see Display messages
 - Capacities**
 - see Technical data
 - Car**
 - see Vehicle
 - Care**
 - Car wash 223
 - Display 228
 - Exterior lights 227
 - Matte finish 225
 - Notes 223
 - Paint 225
 - Plastic trim 228
 - Power washer 224
 - Rear view camera 228
 - Seat belt 229
 - Seat cover 229
 - Sensors 228
 - Soft top 226
 - Tail pipes 228
 - Trim pieces 229
 - Wheels 225
 - Windows 226
 - Wiper blades 227
 - Wooden trim 229
 - Car wash (care) 223**
 - CD player/CD changer (on-board computer) 154**
 - Center console**
 - Lower section 31
 - Upper section 30
 - Central locking**
 - Automatic locking (on-board computer) 159
 - Locking/unlocking (SmartKey) 64
 - Changing bulbs**
 - Important safety notes 98
 - License plate lighting 99
 - Charge maintenance socket 215**
 - Children**
 - In the vehicle 51
 - Restraint systems 51
 - Child seat**
 - Special seat belt retractor 53
 - Top Tether 53
 - Cigarette lighter 203**
 - Climate control**
 - Automatic climate control (dual-zone) 105
 - Controlling automatically 107
 - Cooling with air dehumidification . . 106
 - Defrosting the windows 109
 - Defrosting the windshield 108
 - Important safety notes 104
 - Indicator lamp 107
 - Maximum cooling 108
 - Notes on using automatic climate control 106
 - Overview of systems 104

- Problems with cooling with air dehumidification 107
 - Problem with the rear window defroster 109
 - Refrigerant 282
 - Setting the air distribution 107
 - Setting the airflow 108
 - Setting the air vents 110
 - Setting the temperature 107
 - Switching air-recirculation mode on/off 109
 - Switching on/off 106
 - Switching the MONO function on/off 108
 - Switching the rear window defroster on/off 109
 - Cockpit**
 - Overview 26
 - see Instrument cluster
 - COMAND**
 - see separate operating instructions
 - Combination switch** 96
 - Consumption statistics (on-board computer)** 152
 - Convenience closing feature** 77
 - Convenience opening feature** 77
 - see Opening/closing the side windows (all)
 - Coolant**
 - Display message 177
 - Coolant (engine)**
 - Checking the level 220
 - Notes 283
 - Temperature (on-board computer) . 160
 - Cooling**
 - see Climate control
 - Crash-responsive emergency lighting** 98
 - Cruise control**
 - Cruise control lever 137
 - Deactivating 138
 - Display message 180
 - Driving system 136
 - Function/notes 136
 - Important safety notes 136
 - LIM indicator lamp 137
 - Setting a speed 137
 - Storing and maintaining current speed 137
 - Cup holder**
 - Center console 202
 - Important safety notes 202
 - Curb weight**
 - see Technical data
 - Customer Assistance Center (CAC)** ... 22
 - Customer Relations Department** 22
- D**
- Dashboard**
 - see Cockpit
 - Data**
 - see Technical data
 - Daytime running lamps**
 - Display message 175
 - Switching on/off (on-board computer) 157
 - Switching on/off (switch) 95
 - Dealership**
 - see Qualified specialist workshop
 - Delayed switch-off**
 - Exterior lighting (on-board computer) 158
 - Interior lighting 159
 - Diagnostics connection** 21
 - Digital speedometer** 152
 - Display (cleaning instructions)** 228
 - Display messages**
 - ASSYST PLUS service interval display 222
 - Calling up (on-board computer) 164
 - Driving systems 180
 - Engine 176
 - Hiding (on-board computer) 164
 - Lights 173
 - Safety systems 170
 - Service interval display 222
 - SmartKey 185
 - Tires 181
 - Vehicle 183
 - Distance recorder** 152
 - see Odometer
 - see Trip odometer

- Door control panel**
 - Overview 33
- Doors**
 - Automatic locking (on-board computer) 159
 - Automatic locking (switch) 71
 - Central locking/unlocking (SmartKey) 64
 - Display message 183, 185
 - Emergency locking 72
 - Emergency unlocking 71
 - Important safety notes 69
 - Opening (from inside) 70
- Draft stop** 80
- Drinking and driving** 132
- Drinks holder**
 - see Cup holder
- Drive program** 122
 - Automatic 124
 - Manual 126
 - SETUP (on-board computer) 160
- Drive program display** 121
- Driver's door**
 - see Doors
- Driver's seat**
 - see Seats
- Driving abroad**
 - Mercedes-Benz Service 223
 - Symmetrical low beam 94
- Driving lamps**
 - see Daytime running lamps
- Driving on flooded roads** 135
- Driving safety systems**
 - ABS (Anti-lock Braking System) 55
 - ADAPTIVE BRAKE 59
 - BAS (Brake Assist System) 55
 - EBD (electronic brake force distribution) 59
 - ESP® (Electronic Stability Program) 56
 - ETS (Electronic Traction System) 56
 - Important safety information 54
 - Overview 54
- Driving systems**
 - AMG adaptive sport suspension system 138
 - Blind Spot Assist 143
 - Cruise control 136
 - Display message 180
 - PARKTRONIC 139
 - Rear view camera 142
- Driving tips**
 - AMG ceramic high-performance compound brake system 134
 - Brakes 133
 - Break-in period 114
 - Downhill gradient 133
 - Drinking and driving 132
 - Driving abroad 94
 - Driving in winter 135
 - Driving on wet roads 135
 - Exhaust check 133
 - Fuel 132
 - General 132
 - Hydroplaning 135
 - Icy road surfaces 136
 - Limited braking efficiency on salted roads 134
 - Pedals 132
 - Snow chains 252
 - Symmetrical low beam 94
 - Wet road surface 133
- DVD audio (on-board computer)** 154
- DVD video (on-board computer)** 155

E

EASY-ENTRY feature

- Activating/deactivating 159
- Function/notes 88

EASY-EXIT feature

- Crash-responsive 89
- Function/notes 88
- Switching on/off 159

EBD (electronic brake force distribution)

- Display message 165
- Function/notes 59

Electrical fuses

- see Fuses

Electronic Stability Program

- see ESP® (Electronic Stability Program)

Electronic Traction System

- see ETS

- Emergency release**
 - Driver's door 71
 - Trunk 75
 - Vehicle 71
 - Emergency Tensioning Devices**
 - Function 50
 - Safety guidelines 37
 - Emissions control**
 - Service and warranty information 18
 - Engine**
 - Display message 176
 - Engine number 278
 - Irregular running 118
 - Starting 116
 - Starting problems 118
 - Starting the engine with the key 116
 - Starting with the KEYLESS-GO
 - start function 116
 - Switching off 130
 - Engine diagnostics warning lamp** 194
 - Engine electronics**
 - Problem (malfunction) 118
 - Engine oil**
 - Adding 220
 - Additives 282
 - Checking the oil level 219
 - Display
 - message 178, 179
 - Filling capacity 280
 - Notes about oil grades 282
 - Notes on oil level/consumption 219
 - Temperature (on-board computer) . 160
 - Temperature gauge 148
 - Viscosity 282
 - E-SELECT lever** 119
 - ESP® (Electronic Stability Program)**
 - Deactivating/activating 57
 - Display message 170
 - Function/notes 56
 - Important safety information 56
 - Warning lamp 192
 - ETS (Electronic Traction System)** 56
 - Exhaust check** 133
 - Exhaust tail pipe (cleaning instructions)** 228
 - Exterior lighting**
 - see Lights
 - Exterior mirrors**
 - Adjusting 89
 - Dipping (automatic) 90
 - Folding in/out (automatically) 90
 - Folding in/out (electrically) 90
 - Folding in when locking (on-board computer) 160
 - Out of position (troubleshooting) 90
 - Setting 90
 - Storing settings (memory function) 91
 - Storing the parking position 91
- F**
- Filler cap**
 - see Fuel filler flap
 - First-aid kit** 232
 - Flat tire**
 - Changing a wheel/mounting the spare wheel 236
 - Preparing the vehicle 233
 - Raising the vehicle 237
 - TIREFIT kit 233
 - Floormat** 216
 - Front windshield**
 - see Windshield
 - Fuel**
 - Additives 281
 - Consumption statistics 152
 - Displaying the range 152
 - Driving tips 132
 - Fuel gauge 27
 - Important safety notes 280
 - Premium-grade unleaded gasoline . 281
 - Problem (malfunction) 129
 - Refueling 127
 - Specifications 281
 - Tank content/reserve fuel 280
 - Fuel filler flap, opening/closing** 127
 - Fuel filter (display message)** 180
 - Fuel level**
 - Calling up the range (on-board computer) 152

- Fuel tank**
- Capacity 280
 - Problem (malfunction) 129
- Fuse box**
- Front-passenger footwell 247
 - Rear compartment 248
- Fuses**
- Allocation chart 247
 - Before changing 247
 - Important safety notes 247
- G**
- Garage door opener**
- Clearing the memory 215
 - Notes 212
 - Opening/closing the garage door .. 215
 - Programming (button in the rear-view mirror) 213
- Gasoline** 127
- Gear indicator** 121
- Genuine Mercedes-Benz parts** 276
- Glove box** 200
- H**
- Handbrake**
- see Parking brake
- Hazard warning lamps** 96
- Head bags** 41
- Headlamp cleaning system**
- Notes 284
- Headlamps**
- Adding fluid to cleaning system 221
 - Cleaning system (function) 97
 - Fogging up 97
 - see Automatic headlamp mode
- Head level heating (AIRSCARF)** 87
- Heating**
- see Climate control
- High-beam headlamps**
- Display message 175
 - Switching on/off 96
- Hill start assist** 117
- Hood**
- Closing 219
 - Display message 183
 - Opening 218
- Hydroplaning** 135
- I**
- Ignition lock** 115
- Immobilizer** 59
- Indicator lamps**
- see Warning and indicator lamps
- Indicators**
- see Turn signals
- Instrument cluster**
- Overview 27
 - Settings 157
 - Warning and indicator lamps 28
- Instrument cluster lighting** 158
- Instrument lighting**
- see Instrument cluster lighting
- Interior lighting**
- Automatic control 97
 - Delayed switch-off (on-board computer) 159
 - Emergency lighting 98
 - Manual control 98
 - Overview 97
 - Reading lamp 97
- J**
- Jack**
- Storage location 232
 - Using 237
- Jump start (engine)**
- see Jump starting (engine)
- Jump starting (engine)** 243
- K**
- Key**
- see SmartKey
- KEYLESS-GO start function**
- Display message 185
 - Start/Stop button 115
 - Starting the engine 116
- Key positions**
- SmartKey 115
- Kickdown** 122
- Driving tips 122
- Knee bag** 40

L**Lamps**

see Warning and indicator lamps

Lap time (RACETIMER) 161

License plate lamp

Changing bulbs 99

Display message 175

Lighting

see Lights

Lights

Activating/deactivating the

interior lighting delayed switch-off . 159

Automatic headlamp mode 95

Display message 173

Driving abroad 94

Hazard warning lamps 96

High beam flasher 96

High-beam headlamps 96

Light switch 94

Low-beam headlamps 95

Switching the daytime running
lamps on/off (on-board

computer) 157

Switching the daytime running
lamps on/off (switch) 95

Switching the exterior lighting
delayed switch-off on/off (on-

board computer) 158

Switching the surround lighting
on/off (on-board computer) 158

Turn signals 96

see Changing bulbs

LIM indicator lamp

Cruise control 137

Locking

see Central locking

Locking (doors)

Automatic 71

Emergency locking 72

From inside (central locking
button) 70

Locking centrally

see Central locking

Locking verification signal (on-

board computer) 159

Low-beam headlamps

Display message 174

Setting for driving abroad
(symmetrical) 94

Switching on/off 95

M

M+S tires 252

Malfunction message

see Display messages

Manual drive program 126

Matte finish (cleaning

instructions) 225

mbrace

Call priority 209

Display message 173

Downloading destinations
(COMAND) 209

Emergency call 206

Important safety notes 205

Locating a stolen vehicle 210

MB info call button 208

Remote vehicle locking 210

Roadside Assistance button 207

Search & Send 209

Self-test 205

System 205

Mechanical key

Function/notes 65

Locking vehicle 72

Unlocking the driver's door 71

Memory card (audio) 154

Memory function 91

Message memory (on-board

computer) 164

Messages

see Display messages

Mirrors

see Exterior mirrors

see Rear-view mirror

see Vanity mirror

Mobile phone

Menu (on-board computer) 155

Modifying the programming

(SmartKey) 65

- MP3**
 Operation 154
 see separate operating instructions
- Multifunction display**
 Function/notes 149
 Permanent display 157
- Multifunction steering wheel**
 Operating the on-board computer . 149
 Overview 29
- N**
- Navigation**
 Menu (on-board computer) 153
 On-board computer 153
 see separate operating instructions
- Notes on breaking-in a new vehicle** 114
- O**
- Occupant Classification System (OCS)**
 Faults 46
 Operation 42
 System self-test 45
- Occupant safety**
 Children in the vehicle 51
 System overview 36
- Octane number (fuel)** 281
- Odometer** 152
 see Trip odometer
- On-board computer**
 AMG menu 160
 Audio menu 154
 Convenience submenu 159
 Displaying a service message 222
 Display messages 164
 Factory settings 160
 Important safety notes 148
 Instrument cluster submenu 157
 Lighting submenu 157
 Menu overview 151
 Message memory 164
 Navigation menu 153
 Operation 149
 RACETIMER 161
 Service menu 157
 Settings menu 157
 Standard display 152
 Telephone menu 155
 Trip menu 152
 Vehicle submenu 159
 Video DVD operation 155
- Opening and closing** 69
- Operating safety**
 Diagnostics connection 21
- Operating system**
 see On-board computer
- Outside temperature display** 149
- Overhead control panel** 32
- P**
- Paint code number** 277
- Paintwork (cleaning instructions)** ... 225
- Panic alarm** 54
- Parcel net** 201
- Parking** 129
 Important safety notes 129
 Position of exterior mirror, front-passenger side 91
 Rear view camera 142
 see PARKTRONIC
- Parking aid**
 see Exterior mirrors
 see PARKTRONIC
- Parking brake**
 Display message 165
 Electric parking brake 130
- PARKTRONIC**
 Deactivating/activating 141
 Driving system 139
 Function/notes 139
 Problem (malfunction) 142
 Range of the sensors 140
 Warning display 141
- PASSENGER AIR BAG OFF indicator lamp** 42
- Pedals** 132
- Plastic trim (cleaning instructions)** . 228
- Power steering**
 Filling capacity 280
- Power washers** 224
- Power windows**
 see Side windows

Product information	18
Program selector	122
Pulling away	117

Q

Qualified specialist workshop	21
--	----

R

RACE START	123
RACETIMER (on-board computer)	161
Radio	
Selecting a station	154
see separate operating instructions	
Reading lamp	97
Rear spoiler	
Display message	189
Extending/retracting	210
Problem	212
Rear view camera	
Cleaning instructions	228
Function/notes	142
Rear-view mirror	
Anti-glare (manual)	89
Dipping (automatic)	90
Rear window defroster	
Problem (malfunction)	109
Switching on/off	109
Refueling	
Fuel gauge	27
Important safety notes	127
Refueling process	127
see Fuel	
Remote control	
Garage door opener	212
Reporting safety defects	22
Reserve (fuel tank)	
see Fuel	
Reserve fuel	
Display message	179
Warning lamp	195
see Fuel	
Restraint system	
see SRS (Supplemental Restraint System)	
Roadside Assistance (breakdown)	19

Roof

see Soft top

Route

see Route guidance (navigation)

Route guidance (navigation)	153
--	-----

S**Safety**

Children in the vehicle	51
Child restraint systems	51
Occupant Classification System (OCS)	42
Overview of occupant safety systems	36

Safety systems

see Driving safety systems

Seat belts

Belt force limiters	50
Cleaning	229
Correct usage	48
Emergency Tensioning Devices	50
Fastening	49
Important safety guidelines	47
Releasing	49
Safety guidelines	37
Special seat belt retractor	53
Warning lamp	191
Warning lamp (function)	49

Seats

Adjusting (electrically)	86
Adjusting lumbar support	86
Cleaning the cover	229
Correct driver's seat position	84
Important safety notes	85
Seat heating problem	87
Storing settings (memory function)	91
Switching AIRSCARF on/off	87
Switching seat heating on/off	86

Selector lever

Positions	119
-----------------	-----

Sensors (cleaning instructions)	228
--	-----

Service Center

see Qualified specialist workshop

Service interval display

Displaying service messages	222
Hiding service messages	222

- Notes 222
- Service messages 222
- Service menu (on-board computer)** . 157
- Service products**
 - Brake fluid 282
 - Capacities 280
 - Coolant (engine) 283
 - Engine oil 282
 - Fuel 280
 - Important safety notes 278
 - Notes 278
 - Refrigerant (air-conditioning system) 282
 - Washer fluid 284
- Settings**
 - Factory (on-board computer) 160
 - On-board computer 157
- Setting the air distribution** 107
- Setting the airflow** 108
- SETUP (on-board computer)** 160
- Shift ranges** 125
- Side impact air bag** 40
- Side marker lamp (display message)** 176
- Side windows**
 - Convenience closing feature 77
 - Convenience opening feature 77
 - Important safety information 75
 - Opening/closing 76
 - Opening/closing (all) 77
 - Problem (malfunction) 77
- SmartKey** 69
 - Changing the battery 66
 - Changing the programming 65
 - Checking the battery 66
 - Convenience closing feature 77
 - Convenience opening feature 77
 - Display message 185
 - Door central locking/unlocking 64
 - Loss 67
 - Mechanical key 65
 - Opening/closing soft top 79
 - Problem (malfunction) 67
 - Starting the engine 116
 - Unlocking/locking vehicle 69
- SmartKey positions**
 - KEYLESS-GO start function 115
- Snow chains** 252
- Socket**
 - Glove box 204
- Sockets**
 - Center console 204
 - Points to observe before use 204
- Soft top**
 - Cleaning 226
 - Display message 184
 - Important safety notes 78
 - Opening/closing (SmartKey) 79
 - Opening/closing (with soft-top switch) 78
 - Problem (malfunction) 82
 - Relocking 80
 - wind screen 80
- Soft-top switch** 78
- Spare wheel**
 - see Emergency spare wheel
- Specialist workshop** 21
- Speed, controlling**
 - see Cruise control
- Speedometer**
 - Activating/deactivating the additional speedometer 157
 - Digital 152
 - In the Instrument cluster 27
 - Selecting the unit of measurement 157
 - see Instrument cluster
- SPORT handling mode**
 - Activating/deactivating 58
 - Warning lamp 193
- SRS (Supplemental Restraint System)**
 - Display message 173
 - Introduction 36
 - Warning lamp 193
 - Warning lamp (function) 36
- Standing lamps**
 - Display message 176
- Starting (engine)** 116
- Steering wheel**
 - Adjusting (electrically) 88
 - Button overview 29
 - Buttons (on-board computer) 149
 - Important safety notes 88

- Paddle shifters 123
 - Storing settings (memory function) 91
 - Stopwatch (RACETIMER)** 161
 - Stowage compartments**
 - Armrest (under) 201
 - Cup holders 202
 - Glove box 200
 - Important safety information 200
 - Parcel net 201
 - Rear wall 201
 - Stowage space**
 - Center console 201
 - Center console (rear) 201
 - Summer opening**
 - see Convenience opening feature
 - Summer tires** 252
 - Sun visor** 202
 - Supplemental Restraint System**
 - see SRS (Supplemental Restraint System)
 - Surround lighting (on-board computer)** 158
 - Suspension tuning**
 - AMG adaptive sport suspension system 138
 - Switching air-recirculation mode on/off** 109
 - Switching off the alarm (ATA)** 59
- T**
- Tachometer** 148
 - Tail lamps**
 - Display message 175
 - Tank**
 - see Fuel tank
 - Tank content**
 - Fuel gauge 27
 - Technical data** 284
 - Notes 276
 - Tires/wheels 272
 - TELEAID**
 - Call priority 209
 - Display message 173
 - Downloading destinations (COMAND) 209
 - Emergency call 206
 - Important safety notes 205
 - Locating a stolen vehicle 210
 - MB info call button 208
 - Remote vehicle locking 210
 - Roadside Assistance button 207
 - Search & Send 209
 - Self-test 205
 - System 205
 - Telephone**
 - Accepting a call 155
 - Menu (on-board computer) 155
 - Number from the phone book 156
 - Redialing 156
 - Rejecting/ending a call 156
 - Temperature**
 - Coolant (on-board computer) 160
 - Engine oil 148
 - Engine oil (on-board computer) 160
 - Outside temperature 149
 - Theft deterrent systems**
 - ATA (Anti-Theft Alarm system) 59
 - Immobilizer 59
 - Theft-deterrent systems**
 - Tow-away alarm 60
 - Timing (RACETIMER)** 161
 - TIREFIT kit** 233
 - Tire pressure**
 - Calling up (on-board computer) 257
 - Checking manually 256
 - Display message 181, 183
 - Maximum 256
 - Notes 254
 - Not reached (TIREFIT) 235
 - Reached (TIREFIT) 235
 - Recommended 253
 - Tire pressure monitoring system**
 - Function/notes 257
 - Restarting 259
 - Warning lamp 196
 - Tires**
 - Aspect ratio (definition) 270
 - Average weight of the vehicle occupants (definition) 269
 - Bar (definition) 268
 - Characteristics 268
 - Checking 251
 - Definition of terms 268
 - Direction of rotation 272

- Display message 181
- Distribution of the vehicle occupants (definition) 271
- DOT, Tire Identification Number (TIN) 268
- DOT (Department of Transportation) (definition) 268
- GAWR (Gross Axle Weight Rating) (definition) 269
- GVW (Gross Vehicle Weight) (definition) 269
- GVWR (Gross Vehicle Weight Rating) (definition) 269
- Important safety notes 250
- Increased vehicle weight due to optional equipment (definition) 269
- Kilopascal (kPa) (definition) 270
- Labeling (overview) 265
- Load bearing index (definition) 271
- Load index 267
- Load index (definition) 270
- Maximum loaded vehicle weight (definition) 269
- Maximum load on a tire (definition) 270
- Maximum permissible tire pressure (definition) 270
- Maximum tire load 263
- Maximum tire load (definition) 270
- Optional equipment weight (definition) 271
- PSI (pounds per square inch) (definition) 270
- Replacing 271
- Service life 251
- Sidewall (definition) 270
- Speed rating (definition) 269
- Storing 272
- Structure and characteristics (definition) 268
- Technical data 274
- Temperature 264
- TIN (Tire Identification Number) (definition) 271
- Tire bead (definition) 270
- Tire pressure (definition) 270
- Tire pressures (recommended) 269
- Tire size (data) 272
- Tire size designation, load-bearing capacity, speed rating 265
- Tire tread 251
- Tire tread (definition) 270
- Total load limit (definition) 271
- Traction 264
- Traction (definition) 271
- Tread wear 264
- Uniform Tire Quality Grading Standards 263
- Uniform Tire Quality Grading Standards (definition) 269
- Unladen weight (definition) 270
- Wear indicator (definition) 271
- Wheel rim (definition) 269
- see Flat tire
- Top Tether** 53
- Tow-away alarm** 60
- Towing**
 - Important safety guidelines 244
 - Installing the towing eye 245
 - Removing the towing eye 246
 - With the rear axle raised 246
- Towing away**
 - With both axles on the ground 246
- Transmission**
 - Driving tips 122
 - Selector lever 119
 - Shift range 125
- Transmission position display** 121
- Transmission positions** 121
- Transporting the vehicle** 246
- Trim pieces (cleaning instructions)** . 229
- Trip computer (on-board computer)** 152
- Trip meter**
 - see Trip odometer
- Trip odometer**
 - Calling up 152
 - Resetting (on-board computer) 152
- Trunk**
 - Emergency release 75
 - Important safety guidelines 73
 - Locking separately 74
 - Opening (automatically from inside) 74

- Trunk lid**
 Display message 183
 Opening/closing 73, 74
- Trunk load (maximum)**
 see Technical data
- Turn signals**
 Display message 174
 Switching on/off 96
- Type identification plate**
 see Vehicle identification plate
- U**
- Unlocking**
 Emergency unlocking 71
 From inside the vehicle (central
 unlocking button) 70
- Upshift indicator** 126
- V**
- Vanity mirror (in sun visor)** 203
- Vehicle**
 Correct use 22
 Data acquisition 23
 Display message 183
 Equipment 18
 Individual settings 157
 Limited Warranty 22
 Loading 259
 Locking (in an emergency) 72
 Locking (SmartKey) 64
 Lowering 240
 Maintenance 19
 Parking for a long period 131
 Raising 237
 Reporting problems 22
 Towing away 244
 Transporting 246
 Unlocking (in an emergency) 71
 Unlocking (SmartKey) 64, 69
- Vehicle battery**
 see Battery (vehicle)
- Vehicle data**
 see Technical data
- Vehicle dimensions**
 see Technical data
- Vehicle emergency locking** 72
- Vehicle identification number**
 see VIN
- Vehicle identification plate** 277
- Vehicle tool kit** 232
- Vehicle weights**
 see Technical data
- Video (DVD)** 155
- VIN** 277
- W**
- Warning and indicator lamps**
 ABS 192
 Brakes 190, 192
 Cruise control 137
 Engine diagnostics 194
 ESP® 192
 Fuel tank 195
 Overview 28
 PASSENGER AIR BAG OFF
 indicator lamp 42
 Reserve fuel 195
 Seat belt 191
 SPORT handling mode 193
 SRS 193
 Tire pressure monitor 196
- Warranty** 277
- Washer fluid**
 Display message 184
 see Windshield washer system
- Weight**
 see Technical data
- Wheel bolt tightening torque** 240
- Wheel chock** 236
- Wheels**
 Changing a wheel 236
 Checking 251
 Cleaning 225
 Important safety notes 250
 Interchanging/changing 271
 Mounting a wheel 239
 Removing a wheel 239
 Storing 272
 Tightening torque 240
 Wheel size/tire size 272
- Windows**
 Cleaning 226
 see Side windows

Windshield washer system	221
Notes	284
Windshield wipers	
Problem (malfunction)	101
Replacing the wiper blades	100
Switching on/off	99
Winter driving	
Important safety notes	252
Slippery road surfaces	136
Snow chains	252
Winter tires	
M+S tires	252
Wiper blades	
Cleaning	227
Important safety notes	100
Wooden trim (cleaning instructions)	229
Workshop	
see Qualified specialist workshop	

Product information

Mercedes-Benz recommends that you use genuine Mercedes-Benz parts, conversion parts and accessories that have been approved for the type of vehicle.

Mercedes-Benz tests genuine parts as well as conversion parts and accessories which have been specifically approved for your vehicle for their reliability, safety and suitability. Despite ongoing market research, Mercedes-Benz is unable to assess other parts. Therefore, Mercedes-Benz accepts no responsibility for the use of such parts in Mercedes-Benz vehicles, even if they have been independently or officially approved. The use of non-approved parts could affect your vehicle's operating safety. Mercedes-Benz therefore recommends that you use genuine Mercedes-Benz parts, conversion parts and accessories that have been approved for the type of vehicle. Genuine Mercedes-Benz parts, approved conversion parts and accessories are available from any authorized Mercedes-Benz Center. Here, you will receive advice about permissible technical modifications, and the parts will be professionally installed.

Operator's Manual

Notes on the Operator's Manual

This Operator's Manual contains a great deal of helpful information. We urge you to read it carefully and familiarize yourself with the vehicle before driving.

For your own safety and longer service life of the vehicle, we urge you to follow the instructions and warnings contained in this Operator's Manual. Ignoring them could result in damage to the vehicle or personal injury to you or others. Vehicle damage caused by failure to follow instructions is not covered by the Mercedes-Benz Limited Warranty.

Vehicle equipment

This Operator's Manual describes all models and all standard and optional equipment of your vehicle available at the time of going to print. Country-specific differences are possible. Please note that your vehicle may not be equipped with all features described. This also applies to safety-related systems and functions. The equipment in your vehicle may therefore differ from some of the descriptions or illustrations.

The original purchase agreement lists all systems installed in your vehicle.

Contact an authorized Mercedes-Benz Center if you have any questions about equipment or operation.

The Operator's Manual and the Maintenance Booklet are important documents and should be kept in the vehicle.

Service and vehicle operation

Service and literature

Your vehicle is covered under the terms of the warranties printed in the Service and Warranty Information booklet. Your authorized Mercedes-Benz Center will exchange or repair any defective parts originally installed in the vehicle in accordance with the terms of the following warranties:

- New Vehicle Limited Warranty
- Emission Systems Warranty
- Emission Performance Warranty
- California, Connecticut, Maine, Massachusetts, New York, Pennsylvania, Rhode Island and Vermont Emission Control Systems Warranty
- State warranty enforcement laws (lemon laws)

Information for customers in California

Under California law you may be entitled to a replacement of your vehicle or a refund of the purchase price or lease price, if after a reasonable number of repair attempts Mercedes-Benz USA, LLC and/or its authorized repair or service facilities fail to fix one or more substantial defects or malfunctions in the vehicle that are covered by its express warranty. During the period of 18 months from original delivery of the vehicle or the accumulation of 18 000 miles (approximately 29 000 km) on the odometer of the vehicle, whichever occurs first, a reasonable number of repair attempts is presumed for a retail buyer or lessee if one or more of the following occurs:

- (1) the same substantial defect or malfunction results in a condition that is likely to cause death or serious bodily injury if the vehicle is driven, that defect or malfunction has been subject to repair two or more times, and you have directly notified Mercedes-Benz USA, LLC in writing of the need for its repair.
- (2) the same substantial defect or malfunction of a less serious nature than category (1) has been subject to repair four or more times and you have directly notified Mercedes-Benz in writing of the need for its repair.
- (3) the vehicle is out of service by reason of repair of the same or different substantial defects or malfunctions for a cumulative total of more than 30 calendar days.

Please send your written notice to:
Mercedes-Benz USA, LLC
Customer Assistance Center
One Mercedes Drive
Montvale, NJ 07645-0350

Maintenance

The Service and Warranty Booklet describes all the necessary maintenance work which should be done at regular intervals.

Always have the Service and Warranty Booklet with you when you bring the vehicle to an authorized Mercedes-Benz Center. The service advisor will record every service for you in the Service and Warranty Booklet.

Breakdown assistance

The Mercedes-Benz Roadside Assistance Program offers technical help in the event of a breakdown. Calls to the toll-free Roadside Assistance Hotline are answered by our agents 24 hours a day, 365 days a year.

**1-800-FOR-MERCEdes(1-800-367-6372)
(USA)**

1-800-387-0100 (Canada)

For additional information, refer to the Mercedes-Benz Roadside Assistance Program brochure (USA) or the "Roadside Assistance" section in the Service and Warranty booklet (Canada). You will find both in your vehicle literature portfolio.

Change of address or change of ownership

In the event of a change of address, please send us the "Change of Address Notice" found in the Service and Warranty Information Booklet, or simply call the Mercedes-Benz Customer Assistance Center (in the USA) at the hotline number 1-800-FOR-MERCEdes(1-800-367-6372) or Customer Service Center (in Canada) at 1-800-387-0100. This will assist us in contacting you in a timely manner should the need arise.

If you sell your Mercedes, please leave the entire literature in the vehicle so that it is available to the next owner.

If you bought this vehicle used, be sure to send in the "Notice of Purchase of Used Car" found in the Service and Warranty Information Booklet, or call the Mercedes-Benz Customer Assistance Center (in the USA) at 1-800-FOR-MERCEdes(1-800-367-6372) or Customer Service (in Canada) at 1-800-387-0100.

Vehicle operation outside the USA and Canada

If you plan to operate your vehicle in foreign countries, please be aware that:

- service facilities or replacement parts may not be readily available.
- unleaded fuel for vehicles with a catalytic converter may not be available. Leaded fuel may cause damage to the catalytic converter.
- the fuel may have a considerably lower octane rating. Unsuitable fuel can cause engine damage.

Some Mercedes-Benz models are available for delivery in Europe through our European Delivery Program. For details, consult an authorized Mercedes-Benz Center or write to one of the following addresses.

In the USA

Mercedes-Benz USA, LLC
European Delivery Department
One Mercedes Drive
Montvale, NJ 07645-0350

In Canada

Mercedes-Benz Canada, Inc.
European Delivery Department
98 Vanderhoof Avenue
Toronto, Ontario M4G 4C9

Operating safety

Safety notes

WARNING

Work improperly carried out on electronic components and associated software could cause them to cease functioning. Because the vehicle's electronic components are interconnected, any modifications made may produce an undesired effect on other systems. Electronic malfunctions could seriously impair the operating safety of your vehicle.

Contact an authorized Mercedes-Benz Center for repairs or modifications to electronic components.

Other improper work or modifications on the vehicle could also have a negative impact on the operating safety of the vehicle.

Some safety systems only function when the engine is running. You should therefore never turn off the engine while driving.

WARNING

Heavy blows against the vehicle underbody or tires/wheels may cause serious damage and impair the operating safety of your vehicle. Such blows can be caused, for example, by running over an obstacle, road debris or a pothole.

If you feel a sudden significant vibration or ride disturbance, or you suspect that damage to your vehicle has occurred:

- turn on your hazard warning flashers.
- slow down carefully.
- drive with caution to an area which is a safe distance from the road.

Inspect the vehicle underbody and tires/wheels for possible damage. If the vehicle appears unsafe, have it towed to the nearest authorized Mercedes-Benz Center or other qualified maintenance or repair facility for further inspection or repairs.

General notes

i USA only:

This device complies with Part 15 of the FCC Rules. Operation is subject to the following two conditions:

1. This device may not cause harmful interference, and
2. this device must accept any interference received, including interference that may cause undesired operation.

Any unauthorized modification to this device could void the user's authority to operate the equipment.

The Product label with FCC ID and IC certification number can be found in the battery case of the SmartKey.

i Canada only:

This device complies with RSS-210 of Industry Canada. Operation is subject to the following two conditions:

1. This device may not cause interference, and
2. this device must accept any interference received, including interference that may cause undesired operation of the device.

Any unauthorized modification to this device could void the user's authority to operate the equipment.

The Product label with FCC ID and IC certification number can be found in the battery case of the SmartKey.

Diagnostics connection

⚠ WARNING

If you connect equipment to the diagnostics connection, it can affect the operation of the vehicle systems. This can impair the operating safety of your vehicle while driving. There is a risk of accident.

Do not connect any equipment to the diagnostics connection.

⚠ WARNING

Loose equipment or equipment cables that are connected to the diagnostics connection can obstruct the area around the pedals. The equipment or the cables could get between the pedals in the event of sudden braking or acceleration. As a result, the movement of the pedals may be impaired. There is a risk of accident.

Do not attach any equipment or cables in the driver footwell.

- !** If the engine is switched off and equipment on the diagnostics connection is used, the starter battery may discharge.

The diagnostics connection is only intended for the connection of diagnostic equipment at a qualified specialist workshop.

Connecting equipment to the diagnostics connection can, for example, lead to emissions monitoring information being reset. This may lead to the vehicle failing to meet the requirements of the next emissions test during the main inspection.

Qualified specialist workshop

An authorized Mercedes-Benz Center is a qualified specialist workshop. It has the necessary specialist knowledge, tools and qualifications to correctly carry out the work required on your vehicle. This is especially the case for work relevant to safety.

Observe the notes in the Maintenance Booklet.

Always have the following work carried out at an authorized Mercedes-Benz Center:

- work relevant to safety
- service and maintenance work
- repair work
- alterations, installation work and modifications
- work on electronic components

Correct use

WARNING

There are various warning stickers affixed to your vehicle. Their purpose is to alert you and others to various dangers. Therefore, do not remove any warning stickers unless the sticker clearly states that you may do so.

If you remove any warning stickers, you or others could fail to recognize certain dangers and be injured.

When driving your vehicle observe the following information:

- the safety notes in this manual
- the "Technical data" section in this manual
- traffic rules and regulations
- laws and safety standards pertaining to motor vehicles

Problems with your vehicle

If you should experience a problem with your vehicle, particularly one that you believe may affect its safe operation, we urge you to contact an authorized Mercedes-Benz Center immediately to have the problem diagnosed and rectified. If the problem is not resolved to your satisfaction, please discuss the problem again with a Mercedes-Benz Center or contact us at one of the following addresses.

In the USA

Customer Assistance Center
Mercedes-Benz USA, LLC
One Mercedes Drive
Montvale, NJ 07645-0350

In Canada

Customer Relations Department
Mercedes-Benz Canada, Inc.
98 Vanderhoof Avenue
Toronto, Ontario M4G 4C9

Reporting malfunctions relevant to safety

USA only:

The following text is reproduced as required of all manufacturers according to Title 49, Code of U.S. Federal Regulations, Part 575 pursuant to the National Traffic and Motor Vehicle Safety Act of 1966.

Reporting safety defects

If you believe that your vehicle has a defect which could cause a crash or could cause injury or death, you should immediately inform the National Highway Traffic Safety Administration (NHTSA) in addition to notifying Mercedes-Benz USA, LLC.

If NHTSA receives similar complaints, it may open an investigation, and if it finds that a safety defect exists in a group of vehicles, it may order a recall and remedy campaign.

However, NHTSA cannot become involved in individual problems between you, your dealer, or Mercedes-Benz USA, LLC.

To contact NHTSA, you may call the Vehicle Safety Hotline toll-free at 1-888-327-4236 (TTY: 1-800-424-9153); go to <http://www.safercar.gov>; or write to: Administrator, NHTSA Headquarters, 1200 New Jersey Avenue, SE, West Building, Washington, DC 20590.

You can obtain additional information about vehicle safety from:

<http://www.safercar.gov>.

Limited Warranty

 Follow the instructions in this manual about the proper operation of your vehicle as well as about possible vehicle damage. Damage to your vehicle that arises from culpable contraventions against these instructions is not covered by Daimler AG's Mercedes-Benz Limited Warranty.

Data stored in the vehicle

Information about electronic data acquisition in the vehicle

(Including notice pursuant to California Code § 9951)

Your vehicle records electronic data. If your vehicle is equipped with mbrace¹, data is transmitted in the event of an accident.

This information helps, for example, to test vehicle systems after an accident and to continually improve vehicle safety.

Daimler AG can access this data and submit it:

- for safety research or vehicle diagnosis purposes
- with the consent of the vehicle owner
- on the instruction of prosecuting authorities
- for use in arbitration of disputes that involve Daimler AG, its affiliates or its sales and service organizations
- as otherwise required or permitted by law.

Please observe the mbrace¹ purchase agreement for further details on the recording and transfer of data by this system.

¹ The system is called TELE AID in Canada.

Dashboard 26
Instrument cluster 27
Multifunction steering wheel 29
Center console 30
Overhead control panel 32
Door control panel 33

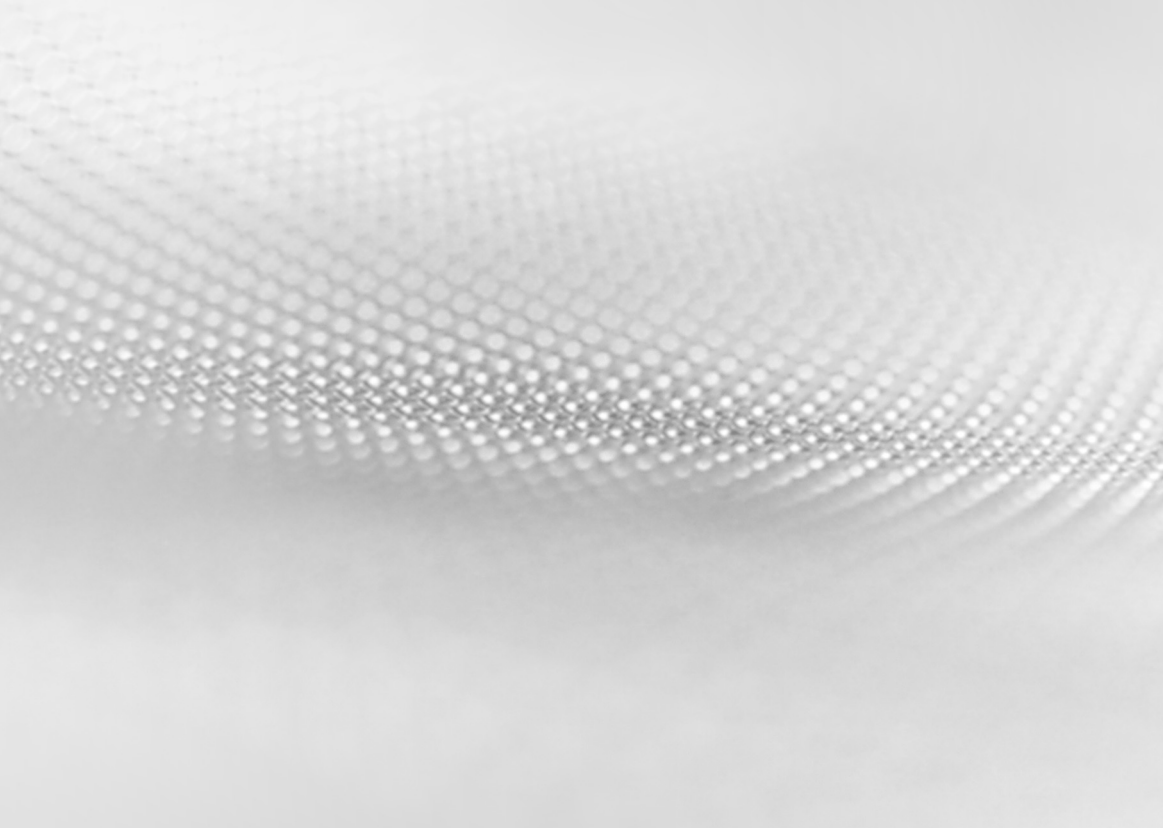

Dashboard

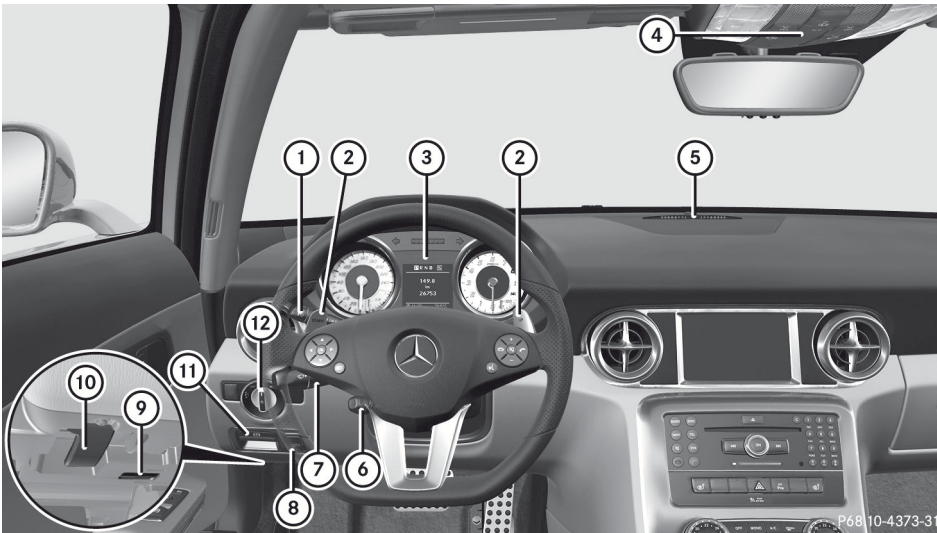

	Function	Page
①	Cruise control lever	137
②	Steering wheel paddle shifters	123
③	Instrument cluster	27
④	Overhead control panel	32
⑤	PARKTRONIC display	141
⑥	Adjusts the steering wheel electrically	88

	Function	Page
⑦	Combination switch	96
⑧	Unlocks the trunk	74
⑨	On-board diagnostic interface	
⑩	Opens the hood	218
⑪	Electric parking brake	130
⑫	Light switch	94

Instrument cluster

Overview

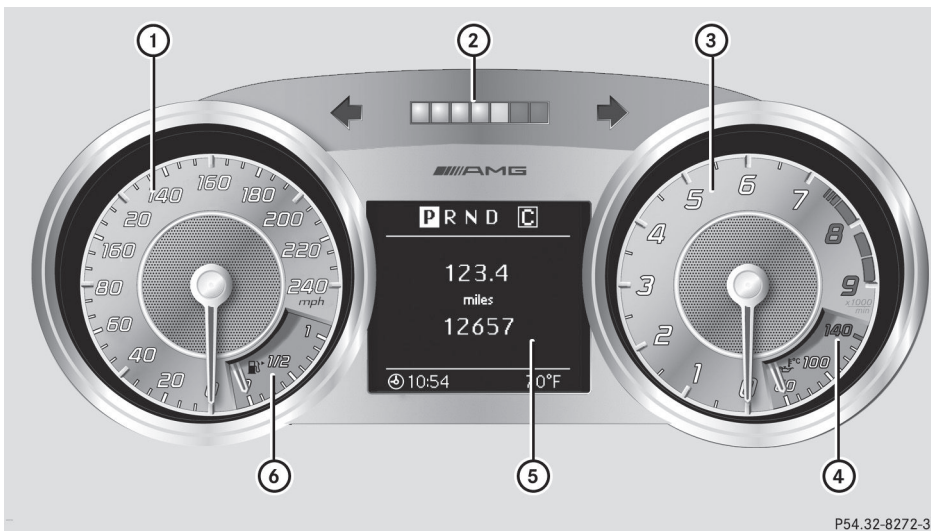

P54.32-8272-31

	Function	Page		Function	Page
①	Speedometer		⑤	Multifunction display	149
②	Upshift indicator	126	⑥	Fuel gauge	
③	Tachometer	148			
④	Engine oil temperature display	148			

Warning and indicator lamps

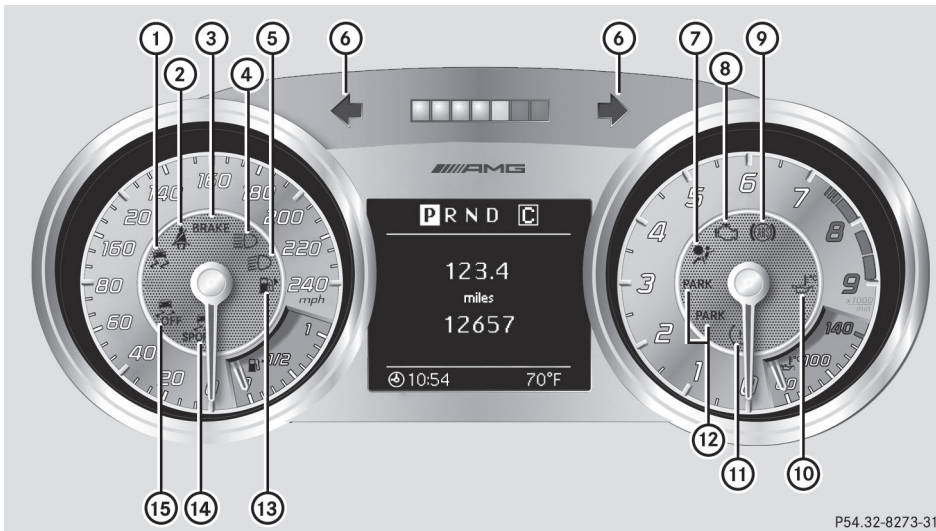

P54.32-8273-31

	Function	Page
①	ESP®	192
②	Seat belt	191
③	Brakes (USA only) ① Brakes (Canada only)	
④	High-beam headlamps	96
⑤	Low-beam headlamps	95
⑥	Turn signal	96
⑦	SRS	193
⑧	Check engine	
⑨	ABS	192

	Function	Page
⑩	Engine oil temperature	148
⑪	Tire pressure	196
⑫	Electric parking brake (USA only) ② Electric parking brake (Canada only)	
⑬	Reserve fuel	195
⑭	SPORT handling mode	58
⑮	ESP® OFF	56

Multifunction steering wheel



At a glance

	Function	Page
①	Multifunction display	149
②	COMAND with display; see the separate operating instructions	
③	Makes/accepts or rejects/ends a call Increases/reduces volume Mute	155
④	Switches on the Voice Control System; see the separate operating instructions	

	Function	Page
⑤	Back or deactivates the Voice Control System	
⑥	Selects a menu Selects a submenu or scrolls through lists Confirms selections and hides display messages	149

Center console

Upper section

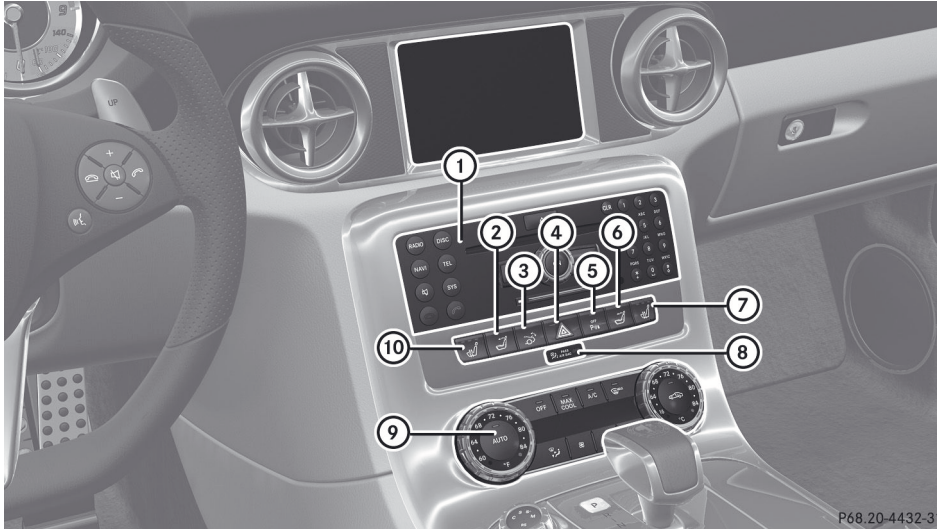

	Function	Page
①	Controls COMAND; see the separate operating instructions	
②	Adjusts AIRSCARF, left (Roadster only)	111
③	Retracts/extends rear spoiler (vehicles with AMG adaptive sport suspension system)	210
④	Hazard warning lamps	96
⑤	PARKTRONIC	141

	Function	Page
⑥	Adjusts AIRSCARF, right (Roadster only)	111
⑦	Seat heating, right	86
⑧	 PASSENGER AIRBAG OFF indicator lamp	42
⑨	Operates dual-zone automatic climate control	105
⑩	Seat heating, left	86

Lower section

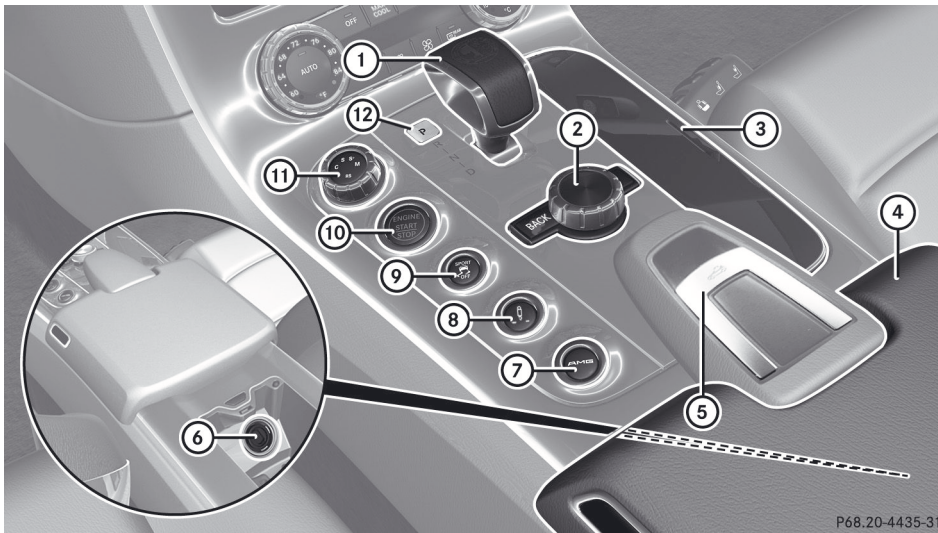

P68.20-4435-31

At a glance





	Function	Page		Function	Page
①	AMG E-SELECT selector lever	119	⑦	Calls up/stores AMG menu (SETUP)	126
②	COMAND controller		⑧	Adjusts AMG adaptive sport suspension system Retracts/extends rear spoiler (vehicles without AMG adaptive sport suspension system)	138 210
③	Stowage compartment 12 V socket Ashtray Cigarette lighter	201 204 203 203	⑨	Activates/deactivates ESP® Activates/deactivates SPORT handling mode	57 58
④	Stowage compartment/ telephone compartment with cup holder	201	⑩	Start/Stop button	115
⑤	Soft top switch (Roadster only)	78	⑪	Selects the drive program	122
⑥	Ignition lock (behind the stowage compartment/ telephone compartment)	115	⑫	Parking lock button P	119

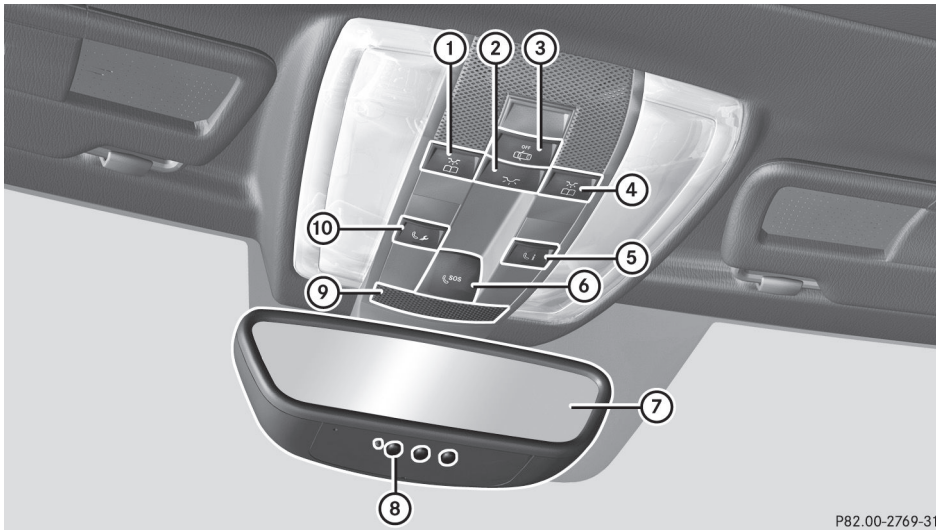

Overhead control panel

At a glance



P82.00-2769-31

	Function	Page
①	 Switches the left-hand reading lamp on/off	97
②	 Switches the interior lighting on/off	98
③	 Switches the automatic interior lighting control on/off	97
④	 Switches the right-hand reading lamp on/off	97
⑤	 Button for MB Info call (mbrace system)	208





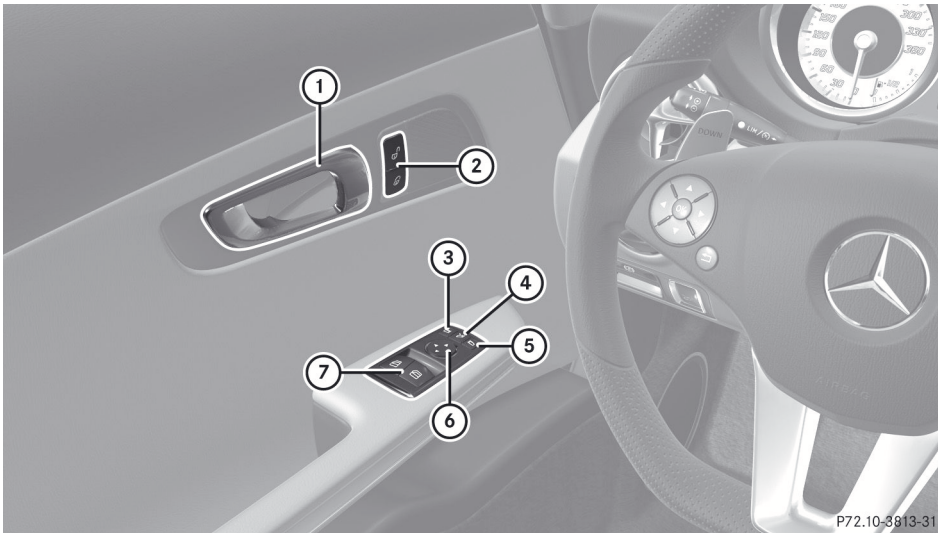

	Function	Page
⑥	 SOS button (mbrace system)	206
⑦	Rear-view mirror	89
⑧	Transmitter buttons for the garage door opener	212
⑨	Microphone for mbrace (emergency call system) telephone and the Voice Control System	
⑩	 Roadside Assistance button (mbrace system)	207

Door control panel



P72.10-3813-31

At a glance

	Function	Page		Function	Page
①	Opens the door	70	⑤	 Selects the right exterior mirror	89
②	  Locks/unlocks the vehicle	70	⑥	 Adjusts the exterior mirrors	89
③	 Selects the left exterior mirror	89	⑦	 Opens/closes the side windows	76
④	 Folds the exterior mirrors in/out electrically	90			

Useful information 36
Occupant safety 36
Children in the vehicle 51
Panic alarm 54
Driving safety systems 54
Anti-theft systems 59



Useful information

- i** This Operator's Manual describes all models and all standard and optional equipment of your vehicle available at the time of publication of the Operator's Manual. Country-specific differences are possible. Please note that your vehicle may not be equipped with all features described. This also applies to safety-related systems and functions.
- i** Please read the information on qualified specialist workshops (▷ page 21).

Occupant safety

Introduction

In this section, you will learn the most important facts about the restraint system components of the vehicle.

The restraint system consists of:

- seat belts
- child restraint systems

Additional protection is provided by:

- SRS (Supplemental Restraint System)
- air bag system components with:
 - PASSENGER AIR BAG OFF indicator lamp
 - front-passenger seat with Occupant Classification System (OCS)

The different air bag systems work independently of each other. The protective functions of the system work in conjunction with each other. Not all air bags are deployed in an accident.

WARNING

Modifications to or work improperly conducted on restraint system components or their wiring, as well as tampering with interconnected electronic systems, can lead to the restraint systems no longer functioning as intended.

Air bags or Emergency Tensioning Devices (ETDs), for example, could deploy

inadvertently or fail to deploy in accidents although the deceleration threshold for air bag deployment is exceeded. Therefore, never modify the restraint systems. Do not tamper with electronic components or their software.

- i** See "Children in the vehicle" (▷ page 51) for more information on infants and children traveling with you in the vehicle and restraints for infants and children.

SRS (Supplemental Restraint System)

Introduction

SRS reduces the risk of occupants coming into contact with the vehicle's interior in the event of an accident. It can also reduce the effect of the forces to which occupants are subjected during an accident.

SRS consists of:

-  SRS warning lamp
- air bags
- air bag control unit (with crash sensors)
- Emergency Tensioning Devices
- seat belt force limiters

SRS warning lamp

SRS functions are checked regularly when you switch on the ignition and when the engine is running. Therefore, malfunctions can be detected in good time.

The  SRS warning lamp in the instrument cluster lights up when the ignition is switched on. It goes out no later than a few seconds after the engine is started.

⚠ WARNING

The SRS self-check has detected a malfunction if the  SRS indicator lamp:

- does not light up at all
- does not go out after approximately four seconds after the engine is started
- comes on after the engine was started or while driving.

For your safety, Mercedes-Benz strongly recommends that you have the system checked as soon as possible at an authorized Mercedes-Benz Center. SRS may otherwise fail to activate when it is needed in the event of an accident, which could lead to serious or fatal injuries. SRS might also be activated unexpectedly and unnecessarily, which could also result in injury.

In addition, work carried out improperly on SRS may render SRS inoperative or cause unintended air bag deployment. Work on the SRS system should only be carried out by qualified specialist personnel. Consult an authorized Mercedes-Benz Center.

If it is necessary to modify an air bag system to accommodate a person with disabilities, contact an authorized Mercedes-Benz Center for details. USA only: for further information contact our Customer Assistance center at 1-800-FOR-MERCEDES (1-800-367-6372).

Safety guidelines for seat belts, Emergency Tensioning Devices (ETDs) and air bags

⚠ WARNING

- Damaged seat belts or seat belts that have been subjected to stress in an accident must be replaced. Their anchoring points must also be checked. Only use seat belts installed or supplied by an authorized Mercedes-Benz Center.
- Air bags and pyrotechnic Emergency Tensioning Devices (ETDs) contain perchlorate material, which may require special handling and regard for the

environment. Check your national disposal guidelines. California residents, see www.dtsc.ca.gov/HazardousWaste/Perchlorate/index.cfm.

- Air bags and ETDs are designed to function on a one-time-only basis. An air bag or ETD that has deployed must be replaced.
- Do not pass seat belts over sharp edges. They could tear.
- Do not make any modification that could change the effectiveness of the seat belts.
- Do not bleach or dye seat belts as this may severely weaken them. In a crash they may not be able to provide adequate protection.
- No modifications of any kind may be made to any components or wiring of the SRS.
- Do not change or remove any component or part of the SRS.
- Do not install additional trim material, seat covers, badges, etc. over the steering wheel hub, front-passenger front air bag cover, outer sides of the seat backrests, door trim panels, or door frame trims.
- Do not install additional electrical/ electronic equipment on or near SRS components and wiring.
- Keep area between air bags and occupants free of objects (e.g. packages, purses, umbrellas, etc.).
- Air bag system components will be hot after an air bag has inflated. Do not touch them.
- Never place your feet on the instrument panel, dashboard, or on the seat. Always keep both feet on the floor in front of the seat.
- Improper repair work on the SRS creates a risk of rendering the SRS inoperative or causing unintended air bag deployment. Work on the SRS must therefore only be performed by qualified technicians. Contact an authorized Mercedes-Benz Center.
- For your protection and the protection of others, when scrapping the air bag unit or ETD, our safety instructions must be

followed. These instructions are available from any authorized Mercedes-Benz Center.

- Given the considerable deployment speed, required inflation volume, and the material of the air bags, there is the possibility of abrasions or other, potentially more serious injuries resulting from air bag deployment.

If you sell your vehicle, Mercedes-Benz strongly recommends that you inform the subsequent owner that the vehicle is equipped with SRS. Also, refer them to the applicable section in the Operator's Manual.

Air bags

Important safety notes

WARNING

Air bags are designed to reduce the potential of injury and fatality rates in certain situations:

- frontal impacts (driver's and front-passenger front air bags and knee bags)
- side impacts (head bags and side impact air bags)

However, no system available today can completely eliminate injuries and fatalities.

When the air bags are deployed, a small amount of powder temporarily comes out of the air bags. This powder generally does not constitute a health hazard and does not indicate that there is a fire in the vehicle. In order to prevent potential breathing difficulties, you should leave the vehicle as soon as it is safe to do so. If you have any breathing difficulty but cannot get out of the vehicle, then get fresh air by opening a side window or door.

WARNING

In order to reduce the potential danger of injuries caused during the deployment of the front air bags, the driver and front passenger

must always be correctly seated and wear their seat belts.

For maximum protection in the event of a collision, you must always be in the normal seat position with your back against the backrest. Fasten your seat belt and make sure that it is correctly positioned on your body.

As the air bag inflates with considerable speed and force, a proper seating position and correct positioning of the hands on the steering wheel will help to keep you at a safe distance from the air bag. Occupants who are not wearing their seat belt, are not seated properly or are too close to the air bag can be seriously injured or killed by an air bag as it inflates with great force instantaneously:

- sit with the seat belt fastened correctly and in a position that is as upright as possible with your back against the backrest.
- move the driver's seat as far back as possible, still permitting proper operation of vehicle controls. The distance from the center of the driver's chest to the center of the air bag cover on the steering wheel must be at least 10 inches (25 cm) or more. You should be able to accomplish this by adjusting the seat and steering wheel. If you have any difficulties, please contact an authorized Mercedes-Benz Center.
- do not lean your head or chest close to the steering wheel or dashboard.
- only hold the steering wheel on the outside. Placing hands and arms inside the rim can increase the risk and potential severity of hand/arm injury when the driver front air bag inflates.
- adjust the front-passenger seat as far back as possible from the dashboard when the seat is occupied.
- Occupants, especially children, should never place their bodies or lean their heads in the area of the door or the seat where the head bag or side impact air bag inflates. This could result in serious injuries or death should the head bag or side impact air bag be deployed. Always sit as upright as

possible, wear the seat belt properly and use an appropriately sized infant restraint, toddler restraint, or booster seat recommended for the size and weight of the child.

Failure to follow these instructions can result in severe injuries to you or other occupants.

If you sell your vehicle, it is important that you make the buyer aware of this safety information. Be sure to give the buyer this Operator's Manual.

WARNING

There is a possibility of a head bag- or side impact air bag-related injury if occupants, especially children, are not properly seated or restrained when next to a head bag or side impact air bag that needs to deploy rapidly in a side impact in order to do its job.

To help avoid the possibility of injury, please follow these guidelines:

- (1) Occupants, especially children, should never place their bodies or lean their heads in the area of the door or the seat where the head bag or side impact air bag inflates. This could result in serious injuries or death should the head bag or side impact air bag be deployed.
- (2) Always sit as upright as possible, and use the seat belts properly. Make sure that children 12 years old and under use an appropriately sized infant restraint, toddler restraint or booster seat recommended for the size and weight of the child.
- (3) Always wear seat belts properly.

If you believe that, even with the use of these guidelines, it would be safer for your passenger seat occupants to have the passenger side head bag or side impact air bag deactivated, then deactivation can be carried out upon your written request at an authorized Mercedes-Benz Center at an additional cost.

Please contact an authorized Mercedes-Benz Center or call the Customer Assistance Center (in the USA) at 1-800-FOR-MERCEDES (1-800-367-6372), or Customer Service (in Canada) at 1-800-387-0100 for details.

The air bags are only deployed if the air bag control unit detects the need for deployment. Only in the event of such a situation will the air bags provide their supplemental protection.

The driver and passenger should always wear their seat belts. Otherwise, it is not possible for the air bags to provide their supplemental protection.

In the event of other types of impacts and impacts below air bag deployment thresholds, air bags will not deploy. The driver and passengers will then be protected to the extent possible by a properly fastened seat belt. A properly fastened seat belt is also needed to provide the best possible protection in a rollover.

Air bags provide additional protection; they are not, however, a substitute for seat belts. All vehicle occupants must fasten their seat belts regardless of whether your vehicle is equipped with air bags or not.

It is important for your safety and that of your passenger to have deployed air bags replaced and to have any malfunctioning air bags repaired. This will help to make sure the air bags continue to perform their protective function for the vehicle occupants in the event of a crash.

Front air bags

The front air bags increase protection for the driver's and front-passenger's head and chest.

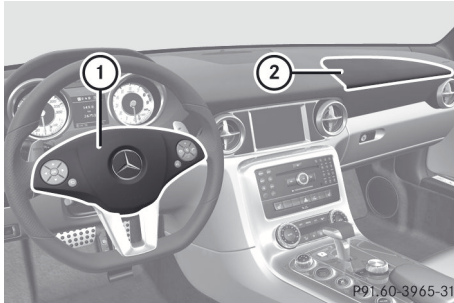

Driver's air bag ① deploys in front of the steering wheel; front-passenger front air bag ② deploys in front of and above the glove box. They are deployed:

- in the event of certain frontal impacts
- if the system determines that air bag deployment can offer additional protection to that provided by the seat belt
- depending on whether the seat belt is being used
- independently of other air bags in the vehicle



If the vehicle overturns, the front air bags are generally not deployed. If the system detects high vehicle deceleration in a longitudinal direction, the front air bags are deployed.

Your vehicle has adaptive, two-stage front air bags. In the event of a collision, the air bag control unit evaluates the vehicle deceleration. When the first deployment threshold is reached, the front air bag is filled with enough propellant gas to reduce the risk of injuries. The front air bag is fully deployed if a second deployment threshold is exceeded within a few milliseconds.

The deployment of the front-passenger front air bag is also influenced by the weight category of the front passenger, which is determined by the Occupant Classification System (OCS) (▷ page 42).

The front air bags are not deployed in situations where a low impact severity is predicted. You will then be protected by the fastened seat belt.

The front-passenger front air bag will only deploy if:

- the system, based on the OCS weight sensor readings, detects that the front-passenger seat is occupied.
- the   indicator lamp in the center console is not lit.
- the air bag control unit predicts a high impact severity.

Driver's/front-passenger knee bag

The driver and front-passenger knee bags enhance the level of protection against:

- knee injuries
- thigh injuries
- lower leg injuries

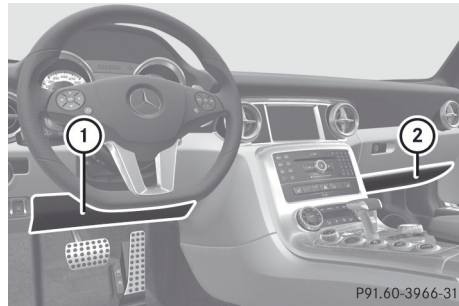

Driver's knee bag ① deploys below the steering wheel. Front-passenger knee bag ② deploys below the glove box. If the system determines that deployment of the knee bags can offer additional protection to that provided by the seat belt in the event of a frontal impact, the system will deploy them together with the front air bags. The knee bags operate best in conjunction with correctly positioned and fastened seat belts.

Side impact air bags

WARNING

The pressure sensors for side impact air bag control are located in the doors. Do not modify any components of the doors or door

trim panels including, for example, the addition of door speakers.

Improper repair work on the doors or the modification or addition of components to the doors create a risk of rendering the side impact air bags inoperative or causing unintended air bag deployment. Work on the doors must therefore only be performed by qualified technicians. Contact an authorized Mercedes-Benz Center.

WARNING

Only use seat covers which have been tested and approved by Mercedes-Benz for your vehicle model. Using other seat covers may interfere with or prevent the deployment of the side impact air bags. Contact an authorized Mercedes-Benz Center for availability.

When deployed, the side impact air bags offer additional protection for the thorax of the vehicle occupants on the side of the vehicle on which the impact occurs. However, they do not protect the:

- head
- neck
- arms

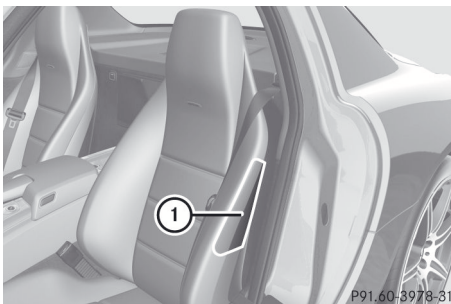

Example: Coupe

Side impact air bags ① deploy next to the outer seat cushions.

The side impact air bags are deployed:

- on the side on which an impact occurs
- at the start of an accident with a high rate of lateral vehicle deceleration or acceleration, e.g. in a side impact
- independently of the use of the seat belt
- independently of the front air bags
- independently of the ETDs

If the vehicle overturns, the side impact air bags are generally not deployed. They are deployed if the system detects high vehicle deceleration or acceleration in a lateral direction and determines that side impact air bag deployment can offer additional protection to that provided by the seat belt.

Side impact air bags will not deploy in side impacts which do not exceed the system's preset deployment thresholds for lateral acceleration/deceleration. You will then be protected by the fastened seat belt.

If the OCS detects that the front-passenger seat is not occupied and the front-passenger seat belt is not fastened (the belt tongue is not engaged in the seat belt buckle), the side impact air bag on the front-passenger side will not deploy. The side impact air bag on the front-passenger side will deploy if the front-passenger seat belt is fastened, regardless of whether the front-passenger seat is occupied or not.

Head bags

The head bags enhance the level of protection for the head (but not chest or arms) of the vehicle occupants on the side of the vehicle on which the impact occurs.

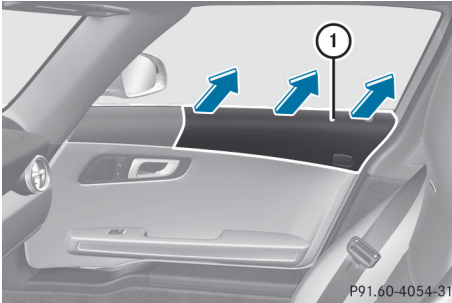

Example: Coupe

Head bags ① deploy in the area of the side window.

They are deployed:



- on the side on which an impact occurs
- at the start of an accident with a high rate of lateral vehicle deceleration or acceleration, e.g. in a side impact
- if the system determines that the vehicle occupants are offered additional protection to that provided by the seat belt
- independently of the use of the seat belt
- independently of the ETDs
- on the driver's side and passenger side, in the event of a vehicle rollover and if the system determines that air bag deployment can offer the vehicle occupants additional protection to that provided by the seat belt
- independently of the front air bags

Head bags ① will not deploy in side impacts which do not exceed the system's preset deployment thresholds for lateral acceleration/deceleration. You will then be protected by the fastened seat belt.

If the OCS has classified the front-passenger seat as unoccupied and the front-passenger seat belt is not fastened, the head bag on the passenger side will not deploy. The head bag on the front-passenger side will deploy if the front-passenger seat belt is fastened, regardless of whether the front-passenger seat is occupied or not.

Occupant Classification System (OCS)

How the occupant classification system works

The Occupant Classification System (OCS) categorizes the occupant on the front-passenger seat using a weight sensor. The front-passenger front air bag and the front-passenger knee bag are deactivated automatically for certain weight categories. The  indicator lamp shows you the current status. When the  indicator lamp is illuminated, the front-passenger front air bag and the front-passenger knee bag are deactivated.

The system does not deactivate:

- the front-passenger side impact air bag
- the front-passenger head bag
- the Emergency Tensioning Devices

To be classified correctly, the front passenger must sit:

- with the seat belt fastened correctly
- in a position that is as upright as possible with their back against the seat backrest
- with their feet on the floor



If the front-passenger's weight is transferred to another object in the vehicle (e.g. by leaning on armrests), OCS may not be able to approximate the occupant's weight category.

To establish whether the front passenger is being properly detected, both the driver and the front passenger should pay attention to the  indicator lamp.

If the front-passenger seat, the seat cover or the seat cushion are damaged, have the necessary repair work carried out at an authorized Mercedes-Benz Center.

For safety reasons, Mercedes-Benz recommends that you only use seat accessories that have been approved by Mercedes-Benz.



WARNING

If the  indicator lamp lights up when the front-passenger seat is occupied by an adult or a larger person, ask the passenger to reposition themselves on the seat so that the  indicator lamp goes out.

In the event of a collision, the air bag control unit will not allow front-passenger front air bag and front-passenger knee bag deployment when the OCS has classified the front-passenger occupant as weighing as much as or less than a typical 12-month-old child in a standard child restraint or if the front-passenger seat is classified as being unoccupied.

If OCS has detected that the front passenger weighs the same as or less than a typical 12-month-old child in a standard child restraint system, the  indicator lamp lights up when the engine is started and remains lit. This indicates that the front-passenger front air bag is deactivated.

If OCS determines that the front-passenger seat is unoccupied, the  indicator lamp lights up once the engine has been started and remains lit. This shows that the front-passenger front air bag and front-passenger knee bag are deactivated.

If OCS determines that the front passenger weighs more than a typical 12 month old child in a standard child restraint system and classifies this as a small person (e.g. a teenager or small adult), the  indicator lamp lights up for approximately 6 seconds when the engine is started. Depending on occupant weight sensor readings from the seat, it will then remain illuminated or go out. If the  indicator lamp is illuminated, the front-passenger front air bag is deactivated. With the  indicator lamp out, the front-passenger front air bag and front-passenger knee bag are deactivated.

If OCS has determined that the front passenger is an adult or medium sized person, the  indicator lamp lights up for

approximately 6 seconds when the engine is started and then goes out. This shows that the front-passenger front air bag and front-passenger knee bag are activated.

If the  indicator lamp is illuminated, the front-passenger front air bag and the front-passenger knee bag are deactivated and are not deployed.

If the  indicator lamp does not light up, the front-passenger air bag is enabled and will be deployed:

- in the event of certain frontal impacts
- if the impact exceeds a preset deployment threshold
- independently of the other air bags

If the front-passenger air bag is deployed, the rate of inflation is influenced by:

- the rate of vehicle deceleration as assessed by the air bag control unit
- the front passenger's weight category as determined by the OCS

For further information, see "Air bag display messages" (▷ page 171).





WARNING

Children 12 years old and under must be seated and properly secured in an appropriate infant restraint, toddler restraint, or booster seat recommended for the size and weight of the child.

The infant or child restraint must be properly secured with the vehicle's seat belt fully in accordance with the child seat manufacturer's instructions.

Occupants, especially children, should always sit as upright as possible, wear the seat belt properly and use an appropriately sized infant restraint, toddler restraint, or booster seat recommended for the size and weight of the child.

Children can be killed or seriously injured by an inflating air bag. Note the following important information:

- Your vehicle is equipped with air bag technology designed to deactivate the front-passenger front air bag in your vehicle when the system senses the weight of a typical 12-month-old child or less along with the weight of a standard appropriate child restraint on the front-passenger seat.
- A child in a rear-facing child restraint on the front-passenger seat will be seriously injured or even killed if the front-passenger front air bag inflates in a collision which could occur under some circumstances, even with the air bag technology installed in your vehicle.
- If you install a rear-facing child restraint on the front-passenger seat, make sure the  indicator lamp is illuminated, indicating that the front-passenger front air bag is deactivated. Should the  indicator lamp not illuminate or go out while the restraint is installed, please check installation. Periodically check the  indicator lamp while driving to make sure the  indicator lamp is illuminated. If the  indicator lamp goes out or remains out, do not transport a child on the front-passenger seat until the system has been repaired.

A child in a rear-facing child restraint on the front-passenger seat will be seriously injured or even killed if the front-passenger front air bag inflates.

- If you place a child in a forward-facing child restraint on the front-passenger seat:
 - move the seat as far back as possible
 - use the proper child restraint recommended for the age, size and weight of the child
 - secure child restraint with the vehicle's seat belt according to the child seat manufacturer's instructions
- For children larger than a typical 12-month-old child, the front-passenger front air bag may or may not be activated.

If the driver's air bag deploys, this does not mean that the front-passenger front air bag also has to deploy.

The OCS may have detected that the seat:



- is empty or occupied by a person with a weight of up to or less than that of a typical 12-month-old child seated in a standard child restraint
- is occupied by a small individual, such as a young teenager or a small adult
- is occupied by a child in a child restraint system whose weight is greater than that of a typical 12-month-old child.

These are examples of when the OCS deactivates the front-passenger front air bag and front-passenger knee bag. Deactivation takes place although the collision fulfills the criteria for deploying the driver's air bag.





P68.10-4167-31

If the SmartKey has been removed from the ignition lock or has been set to position **0** with

the Start/Stop button,  indicator lamp  does not light up.

WARNING

If the red  SRS warning lamp in the instrument cluster and the  indicator lamp light up simultaneously, the OCS is malfunctioning. The front passenger front air bag will be deactivated in this case. Have the system checked by qualified technicians as soon as possible. Contact an authorized Mercedes-Benz Center.

Only have the seat repaired or replaced at an authorized Mercedes-Benz Center.

In order to ensure proper operation of the air bag system and OCS:

- Sit with the seat belt properly fastened in a position that is as upright as possible with your back against the seat backrest.
- When seated, a passenger should not position him/herself in such a way as to cause the passenger's weight to be lifted from the seat cushion as this may result in the OCS being unable to correctly approximate the passenger's weight category.
- Read and observe all warnings in this chapter.

System self-test

The  indicator lamp illuminates when you:

- turn the SmartKey to position **1** or **2** in the ignition lock
- press the Start/Stop button once or twice

If an adult occupant is properly sitting on the passenger seat and the OCS classifies the occupant as an adult, the  indicator lamp illuminates and goes out again after approximately 6 seconds.

If the seat is not occupied and the OCS classifies the front passenger seat as being unoccupied, the  indicator lamp will illuminate and not go out.

WARNING

If the  indicator lamp does not illuminate, the system is not functioning. You must contact an authorized Mercedes-Benz Center before seating any child on the passenger seat.

For more information, see "Problems with the Occupant Classification System" (> page 46).

WARNING

Never place anything between seat cushion and child seat (e.g. a pillow), since it reduces the effectiveness of the OCS. The underside and rear side child restraint system must be placed entirely on the seat cushion and the backrest of the front-passenger seat backrest.

If necessary, adjust the tilt of the passenger seat backrest.



An incorrectly mounted child seat could cause injuries to the child in case of an accident, instead of increasing protection for the child. Follow the manufacturer's instructions for installation of child restraint systems.

Problems with the occupant classification system

Problem	Possible causes/consequences and ► Solutions
<p>The  indicator lamp illuminates and remains illuminated. The person on the front-passenger seat:</p> <ul style="list-style-type: none"> • has the weight of a typical adult • has been determined by the system not to be a child. 	<p>The OCS is malfunctioning.</p> <ul style="list-style-type: none"> ► Have the OCS checked as soon as possible at an authorized Mercedes-Benz Center. ► Observe the additional display messages in the multifunction display (► page 171).

WARNING

If the  indicator lamp illuminates and remains illuminated when the weight of a typical adult or someone larger than a small individual has been detected on the passenger seat, do not allow any occupant to use the passenger seat until the system has been repaired.

Problem	Possible causes/consequences and ► Solutions
<p>The  indicator lamp does not illuminate and/or does not remain illuminated. The front-passenger seat is:</p> <ul style="list-style-type: none"> • unoccupied • occupied with a weight up to or less than a typical 12-month-old child in a standard child restraint system 	<p>The OCS is malfunctioning.</p> <ul style="list-style-type: none"> ► Make sure there is nothing between the seat cushion and the child seat. ► Check the installation of the child restraint system. ► Make sure that no objects are applying additional weight onto the seat. ► If the  indicator lamp does not illuminate, have the OCS checked as soon as possible at an authorized Mercedes-Benz Center. Do not transport a child on the front-passenger seat as long as the OCS is not functioning. ► Observe the additional display messages in the multifunction display (► page 171).

WARNING

If the  indicator lamp does not illuminate or remains out with the weight of a typical 12-month-old child in a standard child restraint or less, or is unoccupied, on the front-passenger seat, do not transport a child on the front-passenger seat until the system has been repaired.

Exiting in an emergency (Coupe only)

If the vehicle is lying on its roof after an accident, the hinge fasteners of the gullwing doors are released pyrotechnically. You will hear a bang if this is the case. After the fasteners have been released, the doors are forced outwards. Simultaneously, the door locks are unlocked. The  SRS warning lamp lights up.

- i** The hinge fasteners are only released when the control unit recognizes that certain conditions have been fulfilled, e.g. when the vehicle is in a stabilized position on its roof.

The doors can then be moved from the inside/outside by pulling the door handle.

Seat belts

Important safety notes

The use of infant or child restraints is required by law in all 50 states, the District of Columbia, the U.S. territories and all Canadian provinces.

Even where this is not the case, all vehicle occupants should have their seat belts fastened when the vehicle is in motion.

- i** See "Children in the vehicle" (▷ page 51) for further information on infants and children traveling in the vehicle as well as on child restraint systems.

WARNING

Always fasten your seat belt before driving off. Always make sure your passenger is properly restrained. You and your passenger should always wear seat belts.

Failure to wear and properly fasten and position your seat belt considerably increases your risk of injuries and their likely severity in an accident.

If you are ever in an accident, your injuries could be considerably more severe if you have not fastened your seat belt correctly. If you do

not fasten your seat belt, you are much more likely to collide with parts of the vehicle interior or be ejected from it. This may result in serious or fatal injury.

In the same crash, the possibility of serious or fatal injury is considerably reduced if you wear your seat belt properly. The air bags can only offer the intended protection if the occupants are wearing their seat belts properly.

WARNING

Never ride in a moving vehicle with the seat backrest in an excessively reclined position as this can be dangerous. You could slide under the seat belt in a collision. If you slide under it, the seat belt would apply force at the abdomen or neck. That could cause serious or even fatal injuries. The seat backrest and seat belt provide the best restraint when the wearer is in a position that is as upright as possible and the seat belt is properly positioned on the body.

WARNING

Never let more people ride in the vehicle than there are seat belts available. Make sure everyone riding in the vehicle is correctly restrained with a separate seat belt. Never use a seat belt for more than one person at a time.

WARNING

Damaged seat belts or seat belts that have been subjected to stress in an accident must be replaced and their anchoring points must also be checked.

Only use seat belts which have been approved by Mercedes-Benz.

Do not make any modifications to the seat belts. This can lead to unintended activation of the ETDs or to their failure to activate when necessary.

Do not bleach or dye seat belts as this may severely weaken them. In a crash they may not be able to provide adequate protection.

Have all work carried out only by qualified technicians. Contact an authorized Mercedes-Benz Center.

Correct use of the seat belts

WARNING

USE SEAT BELTS PROPERLY

- Seat belts can only work when used properly. Never wear seat belts in any other way than as described in this section, as that could result in serious injuries in the event of an accident.
- Each occupant should wear their seat belt at all times, because seat belts help reduce the likelihood of and potential severity of injuries in accidents, including rollovers. The integrated restraint system includes SRS (driver front air bag, knee bags, front-passenger front air bag, side impact air bags, head air bags), Emergency Tensioning Devices (ETDs) and seat belt force limiters. The system is designed to enhance the protection offered to properly belted occupants in certain frontal (front air bags, knee bags and ETDs) and side (side impact air bags, head air bags and ETDs) impacts which exceed preset deployment thresholds.
- Never wear the shoulder belt under your arm, across your neck or off your shoulder. In a frontal crash, your body would move too far forward. That would increase the chance of head and neck injuries. The seat belt would also apply too much force to the ribs or abdomen, which could severely injure internal organs such as your liver or spleen.

Adjust the seat belt so that the shoulder section is located as close as possible to the middle of the shoulder (it should not touch the neck).

- Position the lap belt as low as possible on your hips and not across the abdomen. If the lap belt is positioned across your

abdomen, it could cause serious injuries in a crash.

- Never wear seat belts over rigid or breakable objects in or on your clothing, such as eyeglasses, pens, keys etc., as these might cause injuries.
- Make sure the seat belt is always fitted snugly. Take special care of this when wearing loose clothing.
- Never use a seat belt for more than one person at a time. Do not fasten a seat belt around a person and another person or other objects at the same time.
- Seat belts should not be worn twisted. In a crash, you would not have the full width of the seat belt to distribute impact forces. The twisted seat belt against your body could cause injuries.
- Pregnant women should also always use a lap-shoulder belt. The lap belt portion should be positioned as low as possible on the hips to avoid any possible pressure on the abdomen.
- Place the seat backrest in a position that is as upright as possible.
- Check your seat belt during travel to make sure it is properly positioned.
- Never place your feet on the instrument panel, dashboard, or on the seat. Always keep both feet on the floor in front of the seat.
- When using a seat belt to secure infant restraints, toddler restraints, or children in booster seats, always follow the child seat manufacturer's instructions.

WARNING

Do not pass seat belts over sharp edges. They could tear.

Do not allow the seat belt to get caught in the door or in the seat adjustment mechanism. This could damage the seat belt.

Never attempt to make modifications to seat belts. This could impair the effectiveness of the seat belts.

Fastening seat belts

WARNING

Children 12 years old and under must be seated and properly secured in an appropriately sized infant restraint, child restraint system, or booster seat recommended for the size and weight of the child. For additional information, see the "Children in the vehicle" section.

A child's risk of serious or fatal injuries is significantly increased if the child restraints are not properly secured in the vehicle and/or the child is not properly secured in the child restraint.

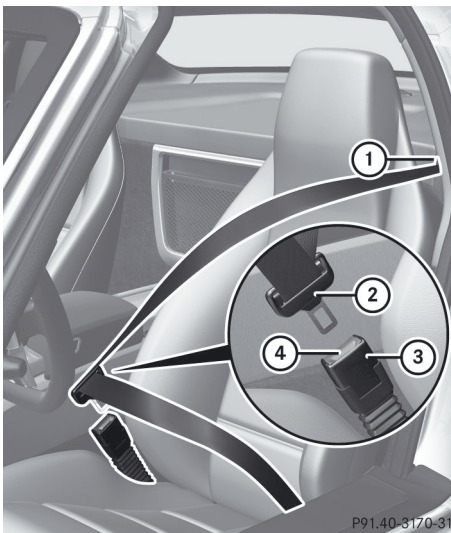

P91.40-3170-31

Example: Coupe

- ▶ Adjust the seat and move the backrest to an almost vertical position (▷ page 85).
- ▶ Pull the seat belt smoothly from belt sash guide ①.
- ▶ Without twisting it, guide the shoulder section of the seat belt across the middle of your shoulder and the lap section across your hips.

- ▶ Engage belt tongue ② in buckle ③.
- ▶ If necessary, pull upwards on the shoulder section of the seat belt to tighten the belt across your body.

The seat belt on the front-passenger side is equipped with a special seat belt retractor to secure child restraint systems properly on the front-passenger seat. For further information about special seat belt retractors, see (▷ page 53).

For more information about releasing the seat belt with release button ④, see "Releasing seat belts" (▷ page 49).

Releasing seat belts

- ▶ Press release button ④ (▷ page 49) and guide belt tongue ② (▷ page 49) back towards belt sash guide ① (▷ page 49).



! Make sure that the seat belt is fully rolled up. Otherwise, the seat belt or belt tongue will be trapped in the door or in the seat mechanism. This could damage the door, the door trim panel and the seat belt. Damaged seat belts can no longer fulfill their protective function and must be replaced. Consult an authorized Mercedes-Benz Center.

Belt warning for the driver and front passenger

Regardless of whether the driver's and front-passenger seat belts have already been fastened, the  seat belt warning lamp lights up for six seconds each time the engine is started. It then goes out if the driver and the front passenger have fastened their seat belts.

If the driver's seat belt is not fastened after the engine is started, an additional warning tone will sound. The warning tone goes out after approximately six seconds or once the driver's seat belt is fastened.

If, after six seconds, the driver or front-passenger have not fastened their seat belts and the doors are closed:

- the  seat belt warning lamp remains illuminated as long as either the driver's or front-passenger seat belt is not fastened.
- the  seat belt warning lamp lights up if the vehicle speed exceeds 15 mph (25 km/h). Additionally, a warning tone will sound with increasing intensity for a maximum of 60 seconds or until the driver's or front-passenger seat belt are fastened.



If the driver or front passenger unfasten their seat belt while the vehicle is in motion, the  seat belt warning lamp lights up and a warning tone sounds again.

The warning tone ceases after 60 seconds even if the driver or front passenger have still not fastened their seat belt. The  seat belt warning lamp stops flashing but remains illuminated.

After the vehicle comes to a standstill, the warning tone is reactivated and the  seat belt warning lamp flashes again if the vehicle speed again exceeds 15 mph (25 km/h).

The  seat belt warning lamp only goes out if:

- both the driver and the front passenger have fastened their seat belts.
- or
- the vehicle is stationary and a door is open.

 For more information on the  seat belt warning lamp, see "Warning and indicator lamps in the instrument cluster, seat belt" (▷ page 191).

Emergency Tensioning Devices and belt force limiters

The seat belts are equipped with ETDs and seat belt force limiters.

 If the front-passenger seat is not occupied, do not engage the seat belt tongue in the buckle on the front-

passenger seat. Otherwise, the Emergency Tensioning Device could be triggered in the event of an accident.

The ETDs tighten the seat belts in an accident, pulling them close against the body.

The ETDs do not correct incorrect seat positions or incorrectly fastened seat belts.

The ETDs do not pull vehicle occupants back towards the backrest.

Seat belt force limiters, when triggered, help to reduce the peak force exerted by the seat belt on the vehicle occupant.

The seat belt force limiters are synchronized with the front air bags, which take on a part of the deceleration force. Thus, the force exerted on the occupant is distributed over a greater area.

When the ignition is switched on, the ETDs cannot be triggered unless:

- the restraint systems are operational; see "SRS warning lamp" (▷ page 36)
- the belt tongue is engaged in the buckle on each of the three-point seat belts.
- the front-passenger seat is occupied and the belt tongue is engaged in the buckle on the front-passenger side

The ETDs are triggered depending on the type and severity of an accident:

- in the event of a head-on or rear-end collision if the vehicle decelerates or accelerates rapidly in a longitudinal direction during the initial stages of the impact
- in the event of a side impact if the vehicle is subjected to high lateral acceleration/ deceleration
- Coupe: in certain situations if the vehicle overturns, and the system determines that it can provide additional protection
- Roadster: if the vehicle overturns

If the Emergency Tensioning Devices (ETDs) are triggered, you will hear a bang, and a small amount of smoke may also be released. Only in rare cases will the bang affect your hearing.

The smoke that is released generally does not constitute a health hazard. The  SRS warning lamp lights up.

WARNING

Pyrotechnic ETDs that were activated must be replaced.

For your safety, when disposing of the pyrotechnic ETDs always follow our safety instructions. These are available at any authorized Mercedes-Benz Center.

Children in the vehicle

Important safety notes

WARNING

When leaving the vehicle, always remove the SmartKey from the ignition lock. Always take the SmartKey with you and lock the vehicle. Do not leave children unattended in the vehicle, even if they are secured in a child restraint system, or with access to an unlocked vehicle. A child's unsupervised access to a vehicle could result in an accident and/or serious personal injury. The children could:

- injure themselves on parts of the vehicle
- be seriously or fatally injured through excessive exposure to extreme heat or cold
- injure themselves or cause an accident with vehicle equipment that can be operated even if the SmartKey is removed from the ignition lock or removed from the vehicle, such as seat adjustment, steering wheel adjustment, or the memory function

If children open a door, they could injure other persons or get out of the vehicle and injure themselves or be injured by following traffic.

Do not expose the child restraint system to direct sunlight. The child restraint system's metal parts, for example, could become very hot, and the child could be burned on these parts.

WARNING

Do not carry heavy or hard objects in the passenger compartment unless they are firmly secured in place.

Unsecured or improperly positioned cargo increases a child's risk of injury in the event of:

- strong braking maneuvers
- sudden changes of direction
- an accident

If an infant or child is traveling in the vehicle:

- ▶ Secure the child using an infant or child restraint appropriate to the age and size of the child.
- ▶ Make sure that the infant or child is properly secured at all times while the vehicle is in motion.

Child restraint systems

Important safety notes

We recommend all infants and children be properly restrained using the child restraint systems at all times while the vehicle is in motion.

The use of infant or child restraints is required by law in all 50 states, the District of Columbia, the U.S. territories and all Canadian provinces.

Infants and small children should always be seated in an infant or child seat restraint system appropriate for the size and weight of the child. They must be properly secured in accordance with the manufacturer's installation instructions for the infant or child seat restraint system. All infant and child seat restraint systems must comply with the US Federal Motor Vehicle Safety Standards 213 and 225 and Canadian Motor Vehicle Safety Standards 213 and 210.2.

A statement by the child restraint manufacturer of compliance with these standards can be found on the instruction

label on the restraint system. You will also find the statement in the instruction manual provided with the child restraint system.

When using any infant restraint, child restraint or booster seat, make sure to carefully read and follow all manufacturer's instructions for installation and use.

Please read the warning labels affixed to the interior of the vehicle or to the infant restraint or child restraint system.

WARNING

Children under 12 years must be secured correctly in a suitable infant or child restraint system or booster seat suitable for the size and weight of the child.



The infant or child restraint system must be correctly secured using the vehicle's seat belt in complete accordance with the child seat manufacturer's instructions.

Occupants, in particular children, must sit as upright as possible, fasten the seat belt correctly and use a suitable infant restraint system, child restraint system or booster seat suitable for the size and weight of the child.

Children can be killed or seriously injured by an inflating air bag. Please observe the following important information:

- your vehicle is equipped with air bag technology designed to deactivate the passenger front air bag in your vehicle when the system senses the weight of a typical 12-month-old child or less along with the weight of a standard appropriate child restraint on the passenger seat.
- a child in a rear-facing child restraint on the passenger seat will be seriously injured or even killed if the passenger front air bag inflates in a collision which could occur under some circumstances, even with the air bag technology installed in your vehicle.
- if you install a rearward-facing child restraint system on the front-passenger seat, make sure the  indicator lamp is illuminated, indicating that the front-passenger front air bag is disabled. If

the  indicator lamp does not light up or goes out when the child restraint system is installed, check the anchorages of the restraint system. Check the

 indicator lamp regularly while driving to ensure that the  indicator lamp is illuminated. If the

 indicator lamp goes out or remains out, you may only carry a child on the front-passenger seat once the system has been repaired.

a child in a rear-facing child restraint on the passenger seat will be seriously injured or even killed if the passenger front air bag inflates.

- when securing a child in a child restraint system on the front-passenger seat, you must:
 - move the front-passenger seat as far back as possible
 - use a child restraint system that is suitable for the age, size and weight of the child
 - observe the manufacturer's installation instructions in order to install and secure the child restraint system correctly.
- for children larger than the typical 12-month-old child, the passenger front air bag may or may not be activated.

WARNING

Infants and small children should never share a seat belt with another occupant. During an accident, they could be crushed between the occupant and seat belt.

A child's risk of serious or fatal injuries is significantly increased if the child restraints are not properly secured in the vehicle and/or the child is not properly secured in the child restraint.

Children too big for a toddler restraint must ride in seats using regular seat belts. Position the shoulder belt across the chest and shoulder, not face or neck. A booster seat may be necessary to achieve proper seat belt positioning for children over 41 lb (18 kg) until

they reach a height where a lap/shoulder belt fits properly without a booster.

When the child restraint is not in use, remove it from the vehicle or secure it with the seat belt to prevent the child restraint from becoming a projectile in the event of an accident.

Special seat belt retractor

The seat belt on the front-passenger seat is equipped with a special seat belt retractor. When enabled, the special seat belt retractor ensures that the seat belt does not slacken once the child seat is secured.

Installing a child restraint system:

- ▶ Always comply with the manufacturer's installation instructions.
- ▶ Pull the seat belt smoothly from the seat belt retractor.
- ▶ Engage the seat belt tongue in the belt buckle.

Activating the special seat belt retractor:

- ▶ Pull the seat belt out fully and let the seat belt retractor retract it again. While the seat belt is retracting, you should hear a ratcheting sound. The special seat belt retractor is enabled.
- ▶ Push down on the child restraint system to take up any slack.

Removing a child restraint system/
deactivating the special seat belt retractor:

- ▶ Always comply with the manufacturer's installation instructions.
- ▶ Press the seat belt release button and guide the belt tongue to the belt outlet. The special seat belt retractor is deactivated.

WARNING

Never release the seat belt buckle while the vehicle is in motion, since the special seat belt retractor will be deactivated.

Installing child restraint systems

Observe the "Important safety notes" section (▷ page 51).

The Top Tether anchorage is installed behind the front-passenger seat.

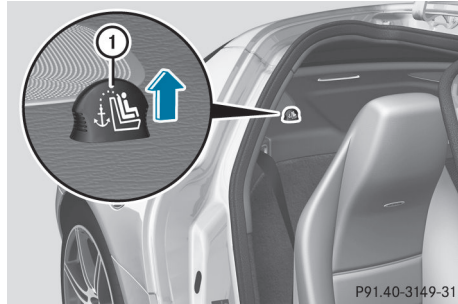

- ▶ Slide the front-passenger seat forward.
- ▶ Remove cover (1) from the Top Tether anchorage in the direction of the arrow.

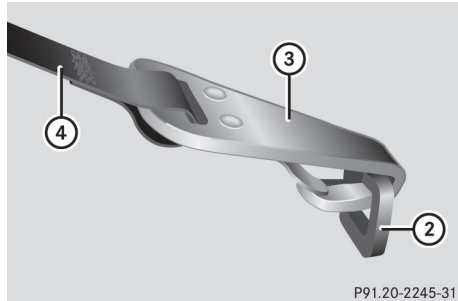

- ▶ Position Top Tether belt (4). Comply with the manufacturer's installation instructions when doing so.
- ▶ Hook Top Tether hook (3) into Top Tether anchorage (2).

Ensure that:

- Top Tether hook (3) is hooked into Top Tether anchorage (2) as shown.
- Top Tether belt (4) is not twisted.

When Top Tether hook (3) is connected, the child restraint system can be secured.

- ▶ Install the child restraint system.
- ▶ Tension Top Tether belt ④. Comply with the manufacturer's installation instructions when doing so.

The child restraint system with Top Tether belt ④ has been removed:

- ▶ Slide cover ① onto Top Tether anchorage ②.

Panic alarm



- ▶ **To activate:** press **PANIC** button ① for at least one second.
An alarm sounds and the exterior lighting flashes.
 - ▶ **To deactivate:** press **PANIC** button ① again.
- or
- ▶ Insert the SmartKey into the ignition lock.
- or
- ▶ Press the Start/Stop button.
The SmartKey must be in the vehicle.

i USA only:

This device complies with Part 15 of the FCC Rules. Operation is subject to the following two conditions:

1. This device may not cause interference, and
2. this device must accept any interference received, including interference that may cause undesired operation of the device.

Any unauthorized modification to this device could void the user's authority to operate the equipment.

The product label with FCC ID and IC certification number can be found in the battery case of the SmartKey.

i Canada only:

This device complies with RSS-210 of Industry Canada. Operation is subject to the following two conditions:

1. This device may not cause interference, and
2. this device must accept any interference received, including interference that may cause undesired operation of the device.

Any unauthorized modification to this device could void the user's authority to operate the equipment.

The product label with FCC ID and IC certification number can be found in the battery case of the SmartKey.

Driving safety systems

Driving safety systems overview

In this section, you will find information about the following driving safety systems:

- ABS (**A**nti-lock **B**raking **S**ystem)
- BAS (**B**rake **A**ssist **S**ystem)
- ESP® (**E**lectronic **S**tability **P**rogram)
- EBD (**e**lectronic **b**rake **f**orce **d**istribution)
- ADAPTIVE BRAKE

Important safety notes

⚠ WARNING

The following factors increase the risk of accidents:

- Excessive speed, especially in turns
- Wet and slippery road surfaces
- Following another vehicle too closely

The driving safety systems described in this section cannot reduce these risks or prevent the natural laws of physics from acting on the vehicle. They cannot increase braking or steering efficiency beyond that afforded by the condition of the vehicle brakes and tires or the traction afforded.

Only a safe, attentive, and skillful driver can prevent accidents.

The capabilities of a vehicle equipped with the driving safety systems described in this section must never be exploited in a reckless or dangerous manner which could jeopardize the user's safety or the safety of others.

Always adjust your driving style to the prevailing road and weather conditions and keep a safe distance to other road users and objects on the street.

If a driving system malfunctions, other driving safety systems may also switch off. Observe indicator and warning lamps that may come on as well as messages in the multifunction display that may appear.

- i** In wintry driving conditions, always use winter tires (M+S tires) and if necessary, snow chains. Only in this way will the driving safety systems described in this section work as effectively as possible.

ABS (Anti-lock Braking System)

Important safety notes

WARNING

Do not pump the brake pedal. Use firm, steady brake pedal pressure instead. Pumping the brake pedal reduces the braking effect.

ABS regulates brake pressure in such a way that the wheels do not lock when you brake. This allows you to continue steering the vehicle when braking.

ABS works from a speed of about 5 mph (8 km/h) upwards, regardless of road-

surface conditions. ABS works on slippery surfaces, even when you only brake gently.

The  warning lamp in the instrument cluster lights up when the ignition is switched on. It goes out when the engine is running.

Braking

If ABS intervenes when braking, you will feel a pulsing in the brake pedal.

- ▶ **If ABS intervenes:** continue to depress the brake pedal with force until the braking situation is over.

- ▶ **To make a full brake application:** depress the brake pedal with full force.

WARNING

If the ABS malfunctions, other driving systems such as the BAS or the ESP® are also switched off. Observe indicator and warning lamps that may come on as well as messages in the multifunction display that may appear.

If the ABS malfunctions, the wheels may lock during hard braking, reducing the steering capability and extending the braking distance.

The pulsating brake pedal can be an indication of hazardous road conditions and functions as a reminder to take extra care while driving.

BAS (Brake Assist System)

Observe the "Important safety notes" section (> page 56).

BAS operates in emergency braking situations. If you depress the brake pedal quickly, BAS automatically boosts the braking force, thus shortening the stopping distance.

- ▶ Keep the brake pedal firmly depressed until the emergency braking situation is over. ABS prevents the wheels from locking.

The brakes will function as usual once you release the brake pedal. BAS is deactivated.

⚠ WARNING

If the BAS malfunctions, the brake system still functions, but without the additional brake boost available that the BAS would normally provide in an emergency braking maneuver. Therefore, the braking distance may increase.

ESP® (Electronic Stability Program)**Important safety notes****⚠ WARNING**

Under no circumstances should you deactivate ESP® when the  ESP® warning lamp in the instrument cluster flashes. Proceed as follows:

- when driving off, apply as little throttle as possible.
- while driving, ease up on the accelerator pedal.
- adapt your speed to suit the prevailing road and weather conditions.

Failure to observe these guidelines could cause the vehicle to skid. ESP® cannot prevent accidents resulting from excessive speed.



- !** Switch the ignition off when:
- the electric parking brake is being tested using a brake dynamometer.
 - the vehicle is being towed with the rear axle raised.

Application of the brakes by ESP® may otherwise destroy the brake system.

- i** Only use wheels with the recommended tire sizes. Only then will ESP® function properly.

You can select between the three following states of ESP®:

- ESP® is activated.
- SPORT handling mode is activated.
- ESP® is deactivated.

ESP® is activated as soon as you start the engine. When SPORT handling mode is activated, the  warning lamp lights up in the instrument panel. When ESP® is deactivated, the  and  warning lamps light up in the instrument panel.

ETS (Electronic Traction System)

Observe the "Important safety notes" section (> page 56).

Traction control is part of ESP®.

Traction control brakes the drive wheels individually if they spin. This enables you to pull away and accelerate on slippery surfaces, for example if the road surface is slippery on one side.

Traction control remains active if you deactivate ESP®.

Characteristics of ESP®**⚠ WARNING**

ESP should not be deactivated during normal driving.

Deactivating ESP SPORT will have the following effects:

- there is no limit to the engine torque.
- the system-based traction control is limited.

"ESP OFF" is designed for driving on closed tracks when the vehicle's natural oversteer and understeer characteristics are desired and requires a highly skilled and experienced driver able to handle these critical driving situations.

You could lose control of your vehicle and cause an accident.

Please be aware of these limits when you switch off ESP.

⚠ WARNING

Activate ESP® as soon as the situations described above no longer apply. ESP® will otherwise not be able to stabilize the vehicle

if the vehicle starts to skid or a wheel starts to spin.

ESP® monitors driving stability and traction, i.e. power transmission between the tires and the road surface.

If ESP® detects that the vehicle is deviating from the direction desired by the driver, one or more wheels are braked to stabilize the vehicle. If necessary, the engine output is also modified to keep the vehicle on the desired course within physical limits. ESP® assists the driver when pulling away on wet or slippery roads. ESP® can also stabilize the vehicle during braking.

If ESP® intervenes, the  warning lamp flashes in the instrument cluster.

WARNING

If the  warning lamp in the instrument cluster flashes, proceed as follows:

- do not deactivate ESP® under any circumstances
- only depress the accelerator pedal as far as necessary when pulling away.
- adapt your driving style to suit the prevailing road and weather conditions.

Otherwise, the vehicle could go into a skid.

ESP® cannot reduce the risk of an accident if you drive too fast. ESP® cannot override the laws of physics.

- i** Only use wheels with the recommended tire sizes. Only then will ESP® function properly.

ESP® is activated automatically when the engine is running. In the following situations, it may be better to activate SPORT handling mode or deactivate ESP®:

- when using snow chains
- in deep snow
- on sand or gravel

WARNING

Activate ESP® as soon as the situations described above no longer apply. Otherwise, ESP® will only be able to stabilize the vehicle to a limited degree if the vehicle starts to skid or if a wheel starts to spin.

Characteristics when ESP® is deactivated

When you deactivate ESP®:



- ESP® no longer improves driving stability.
- engine torque is no longer limited and the drive wheels are able to spin. The spinning wheels produce a cutting effect for better traction.
- traction control is still activated.
- ESP® still provides support when you brake firmly.

- i** If ESP® is deactivated and one or more wheels start to spin, the  warning lamp in the instrument cluster does not flash. In such situations, ESP® will not stabilize the vehicle.

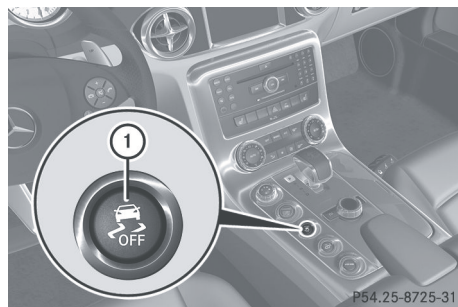

Deactivating/activating ESP®

ESP® is activated as soon as you start the engine.





- **To deactivate ESP®:** press and hold down button **1** until the  and  warning lamps in the instrument panel light up. The **OFF** message appears in the multifunction display.

⚠ WARNING

ESP® is deactivated if the  and  warning lamps in the instrument cluster are lit continuously when the engine is running. There is an increased risk of your vehicle skidding in certain situations.

You should always adapt your driving style to suit the prevailing road and weather conditions.

- **To activate ESP®:** when SPORT handling mode is activated or ESP® is deactivated, press button  briefly.

The  and  warning lamps in the instrument cluster go out. The **ON** message appears in the multifunction display.

SPORT handling mode**⚠ WARNING**

SPORT handling mode should not be switched on during normal driving. Switching on SPORT handling mode will result in the following:

- there is no limit to the engine torque.
- the system-based traction control is limited.

SPORT handling mode is designed for driving on closed tracks when the vehicle's own natural oversteer and understeer characteristics are desired and requires a highly skilled and experienced driver able to handle these critical driving situations.

You could lose control of your vehicle and cause an accident.

Please be aware of these limits when you switch on SPORT handling mode.

Do not switch on SPORT handling mode when a spare wheel is mounted.

⚠ WARNING

Switch off SPORT handling mode and immediately switch on ESP® if one of the previously stated conditions no longer

applies. SPORT handling mode will otherwise only stabilize the vehicle to a limited degree if it begins to lurch or if a wheel spins.

SPORT handling mode raises the intervention threshold for stabilizing the vehicle. This allows for a sportier driving style on designated race circuits and may in certain situations improve the traction in comparison with ESP®.

When SPORT handling mode is activated:

- ESP® only improves driving stability to a limited degree.
- engine torque is only restricted to a limited degree, and the drive wheels are able to spin. The spinning wheels produce a cutting effect for better traction.
- traction control is still activated.
- ESP® still provides support when you brake firmly.

- ⓘ If SPORT handling mode is activated and one or more wheels start to spin, the  warning lamp in the instrument cluster flashes. ESP® only stabilizes the vehicle to a limited degree.

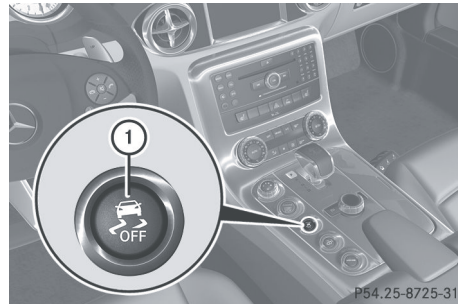

- **To activate SPORT handling mode:** briefly press button .

The  warning lamp in the instrument cluster lights up. The **SPORT handling**

mode message appears in the multifunction display.

- ▶ **To deactivate SPORT handling mode:** briefly press button ①.

The **SPORT** warning lamp in the instrument cluster goes out. ESP® is activated.

EBD (electronic brake force distribution)

Observe the "Important safety notes" section (▷ page 56).

EBD monitors and controls the brake pressure on the rear wheels to improve driving stability while braking.

WARNING

If the EBD malfunctions, the brake system will still function with full brake boost. However, the rear wheels could lock up during emergency braking situations, for example. You could lose control of the vehicle and cause an accident.

Adapt your driving style to the changed driving characteristics.

ADAPTIVE BRAKE

Observe the "Important safety notes" section (▷ page 54).

ADAPTIVE BRAKE enhances braking safety and offers increased braking comfort. In addition to the braking function, ADAPTIVE BRAKE also features the hill start assist function (▷ page 117). For further information, see Driving tips (▷ page 133).

Anti-theft systems

Immobilizer

The immobilizer prevents your vehicle from being started without the correct SmartKey.

When leaving the vehicle, always take the SmartKey with you and lock the vehicle. The engine can be started by anyone with a valid SmartKey that is left inside the vehicle.

- ▶ **To activate with KEYLESS-GO:** switch the engine off and open the driver's door.
- ▶ **To activate with the SmartKey:** remove the SmartKey from the ignition lock.
- ▶ **To deactivate:** switch on the ignition.

- i** The immobilizer is always deactivated when you start the engine.

In the event that the engine cannot be started when the starter battery is fully charged, the immobilizer may be faulty. Contact an authorized Mercedes-Benz Center or call 1-800-FOR-MERCEdes (in USA) or 1-800-387-0100 (in Canada).

ATA (anti-theft alarm system)

A visual and audible alarm is triggered if the alarm system is armed and you open:

- a door
- the trunk lid
- the hood
- Roadster: the glove box
- Roadster: a compartment in the center console
- the vehicle with the mechanical key

The alarm is not switched off, even if you close the open door that has triggered it, for example.

i If the alarm stays on for more than 30 seconds, the mbrace² system initiates a call to the Customer Assistance Center automatically. The emergency call system initiates the call provided that:

- you have subscribed to the mbrace service
- the mbrace service has been activated properly
- the required mobile phone, power supply and GPS are available.

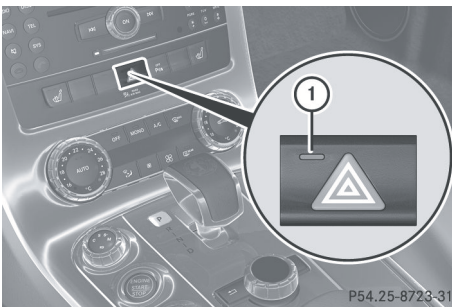

► **To arm:** lock the vehicle with the SmartKey.

The turn signal lamps flash three times and an acoustic warning sounds three times to indicate that the vehicle is locked. Indicator lamp ① flashes to indicate that the alarm system is armed.

i If the turn signal lamps do not flash three times and the acoustic warning does not sound three times, a door or the trunk lid may not be properly closed.

It may be necessary to close the affected door or the trunk lid.

► **To deactivate:** unlock the vehicle with the SmartKey.



The turn signal lamps flash once and an acoustic warning sounds once to indicate that the anti-theft alarm system is switched off.

i Unless you open a door or the trunk lid within 40 seconds of unlocking the vehicle:

- the vehicle will be locked again
- the anti-theft alarm system will be re-armed.

► **To stop the alarm:** press the Start/Stop button in the center console. The SmartKey must be inside the vehicle.

or

► Press the  or  button on the SmartKey.

or

► Insert the SmartKey into the ignition lock. The alarm is switched off.

Tow-away alarm

An audible and visual alarm is triggered if your vehicle's angle of inclination is altered while the tow-away alarm is armed. This occurs if the vehicle is jacked up on one side, for example.

i If the alarm stays on for more than 30 seconds, the mbrace³ system initiates a call to the Customer Assistance Center automatically. The emergency call system initiates the call provided that:

- you have subscribed to the mbrace service
- the mbrace service has been activated properly
- the required mobile phone, power supply and GPS are available.

► **To arm:** lock the vehicle with the SmartKey.

The tow-away alarm is armed after approximately 30 seconds.

► **To deactivate:** unlock the vehicle with the SmartKey.

The tow-away alarm is deactivated automatically.

² TELEAID in Canada.

³ TELEAID in Canada.

To prevent a false alarm, deactivate the tow-away alarm manually if your vehicle:

- is being transported
- is being loaded onto a ferry or car transporter, for example
- is parked on a movable surface, e.g. in a split-level garage

► **To deactivate:** use the Start/Stop button to set SmartKey position **0**.

or

► Remove the SmartKey from the ignition lock.

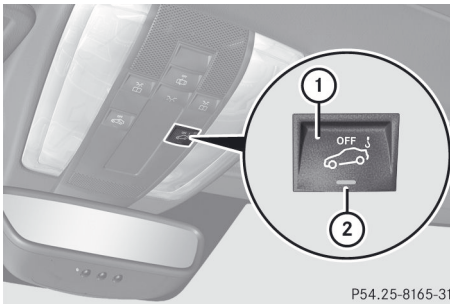

- Press button ①.
Indicator lamp ② lights up briefly.
- Lock the vehicle with the SmartKey.
The tow-away alarm is deactivated.
The tow-away alarm remains deactivated until the vehicle is unlocked and locked again.

Useful information	64
SmartKey	64
Doors	69
Trunk	73
Side windows	75
Soft top (Roadster)	78

Useful information

- i** This Operator's Manual describes all models and all standard and optional equipment of your vehicle available at the time of publication of the Operator's Manual. Country-specific differences are possible. Please note that your vehicle may not be equipped with all features described. This also applies to safety-related systems and functions.
- i** Please read the information on qualified specialist workshops (▷ page 21).

SmartKey

Key function

General notes

- i** USA only:
This device complies with Part 15 of the FCC Rules. Operation is subject to the following two conditions:
 1. This device may not cause harmful interference, and
 2. this device must accept any interference received, including interference that may cause undesired operation.
 Any unauthorized modification to this device could void the user's authority to operate the equipment.
The Product label with FCC ID and IC certification number can be found in the battery case of the SmartKey.
- i** Canada only:
This device complies with RSS-210 of Industry Canada. Operation is subject to the following two conditions:
 1. This device may not cause interference, and
 2. this device must accept any interference received, including interference that may cause undesired operation of the device.

Any unauthorized modification to this device could void the user's authority to operate the equipment.

The Product label with FCC ID and IC certification number can be found in the battery case of the SmartKey.

Locking and unlocking centrally

The SmartKey centrally locks/unlocks:

- the doors
- the trunk lid
- the fuel filler flap
- the glove box
- the stowage/telephone compartment under the armrest

WARNING



If children are left unsupervised in the vehicle, they could:

- open a door locked from inside the vehicle
- start the vehicle using a key which has been left in the vehicle
- release the parking brake

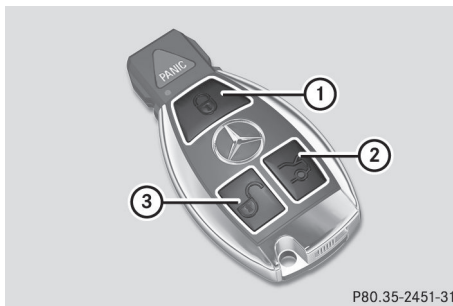
They could thereby endanger themselves and others. Never leave children unsupervised in the vehicle. Always take the key with you when leaving the vehicle, even if you are only leaving it for a short time.



P80.35-2451-31

- ①  To lock the vehicle
- ②  To unlock the trunk lid
- ③  To unlock the vehicle

When unlocking, the turn signals flash once. When locking, they flash three times.

When it is dark, the surround lighting also comes on if it is activated in the on-board computer (▷ page 158).

You can also set an audible signal to confirm that the vehicle has been locked or unlocked. The audible signal can be activated and deactivated using the on-board computer (▷ page 159).



- ▶ **To unlock centrally:** press the  button.

If you do not open the vehicle within approximately 40 seconds of unlocking:



- the vehicle is locked again.
 - the anti-theft alarm system is armed again.
- ▶ **To lock centrally:** press the  button.

Changing the settings of the locking system



You can change the setting of the locking system in such a way that only the driver's door and the fuel filler flap are unlocked. This is useful if you frequently travel on your own.

- ▶ **To change the setting:** press and hold down the  and  buttons simultaneously for approximately six seconds until the battery check lamp (▷ page 66) flashes twice.

The SmartKey now functions as follows:

- ▶ **To unlock the driver's door:** press the  button once.
- ▶ **To unlock centrally:** press the  button twice.
- ▶ **To lock centrally:** press the  button.

Restoring the factory settings

- ▶ Press the  and  buttons simultaneously for approximately six seconds until the battery check lamp flashes twice.



Mechanical key

General notes

If the vehicle can no longer be locked or unlocked with the SmartKey, use the mechanical key.

If you use the mechanical key to unlock and open the driver's door, the anti-theft alarm system will be triggered (▷ page 59).

There are several ways to turn off the alarm:

- ▶ Press the  or  button on the SmartKey.

or

- ▶ Insert the SmartKey into the ignition lock.
- ▶ **To unlock the fuel filler flap:** insert the SmartKey into the ignition lock.

Removing the mechanical key

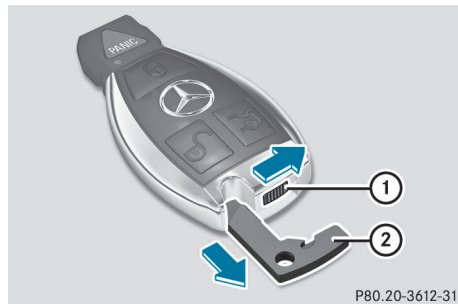

P80.20-3612-31

- ▶ Push release catch ① in the direction of the arrow and at the same time, remove mechanical key ② from the SmartKey.

SmartKey battery

Important safety notes

It is advisable to have batteries replaced at a qualified specialist workshop, e.g. at an authorized Mercedes-Benz Center.

WARNING

Batteries contain toxic substances.

Swallowing batteries can lead to serious health issues or death.



Keep batteries out of the reach of children. Seek medical attention immediately if a battery is swallowed.

WARNING

The SmartKey batteries contain perchlorate material, which may require special handling and regard for the environment. Observe government disposal guidelines. California residents, see www.dtsc.ca.gov/HazardousWaste/Perchlorate/index.cfm.



Checking the battery



- ▶ Press the  or  button. The SmartKey battery is working properly if battery check lamp ① lights up briefly.

If battery check lamp ① does not light up briefly during the test, the SmartKey battery is discharged.

- ▶ Changing the battery (▷ page 66)

- i** The battery can be obtained from any authorized Mercedes-Benz Center.
- i** If the SmartKey battery is checked within the signal range of the vehicle, pressing the  or  button locks or unlocks the vehicle.

Changing the battery

- ▶ Take the mechanical key out of the SmartKey (▷ page 65).

You require a CR 2025 3 V cell battery.

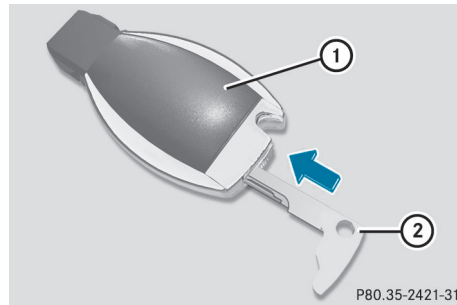

- ▶ Press mechanical key ② into the opening in the SmartKey in the direction of the arrow until battery tray cover ① opens. Do not hold the cover closed while doing so.

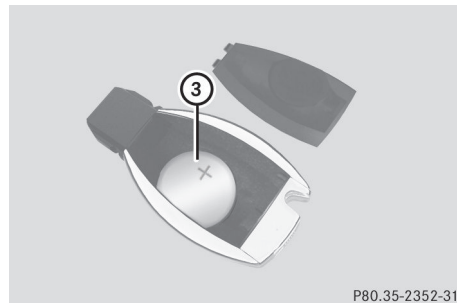

- ▶ Remove the cover of the battery tray.
- ▶ Repeatedly tap the SmartKey against your palm until battery ③ falls out.
- ▶ Insert the new battery with the positive terminal facing upwards. Use a lint-free cloth to do so.
- ▶ Insert the front tabs of the battery tray's cover first, and then press to close it.
- ▶ Check the function of all SmartKey buttons on the vehicle.

Problems with the SmartKey

Problem	Possible causes/consequences and ► Solutions
You cannot lock or unlock the vehicle using the SmartKey.	<p>The SmartKey battery is discharged or nearly discharged.</p> <ul style="list-style-type: none"> ► Point the tip of the SmartKey at the driver's door handle from close range and try to unlock or lock the vehicle again. <p>If this does not work:</p> <ul style="list-style-type: none"> ► Unlock the vehicle using the mechanical key (► page 65). ► Check the SmartKey battery and replace it if necessary (► page 66). <p>The SmartKey is faulty.</p> <ul style="list-style-type: none"> ► Lock or unlock the vehicle using the mechanical key (► page 65). ► Have the SmartKey checked at a qualified specialist workshop.
You have lost a SmartKey.	<ul style="list-style-type: none"> ► Have the SmartKey canceled at an authorized Mercedes-Benz Center. ► Report the loss immediately to the vehicle insurers. ► If necessary, have the locks changed as well.
You have lost the mechanical key.	<ul style="list-style-type: none"> ► Report the loss immediately to the vehicle insurers. ► If necessary, have the locks changed as well.
The engine cannot be started using KEYLESS-GO. The SmartKey is in the vehicle.	<p>A door is open. Therefore, the SmartKey cannot be detected as easily.</p> <ul style="list-style-type: none"> ► Close the door and try to start the vehicle again. <p>There is interference from a powerful source of radio waves.</p> <ul style="list-style-type: none"> ► Start your vehicle with the SmartKey in the ignition lock.

Problem	Possible causes/consequences and ► Solutions
<p>The engine cannot be started using the SmartKey.</p>	<p>The on-board voltage is too low.</p> <ul style="list-style-type: none"> ► Switch off non-essential consumers, such as seat heating or interior lighting, and try to start the engine again. ► Remove the SmartKey and reinsert it into the ignition lock. ► Start the engine within 30 seconds of inserting the SmartKey into the ignition lock. ► Repeat if necessary. <p>If this does not work:</p> <ul style="list-style-type: none"> ► Check the starter battery and charge it if necessary (▷ page 240). <p>or</p> <ul style="list-style-type: none"> ► Jump-start the vehicle (▷ page 243). <p>or</p> <ul style="list-style-type: none"> ► Consult a qualified specialist workshop.
<p>The SmartKey cannot be turned in the ignition lock.</p>	<p>The SmartKey has been in position 0 for a considerable time.</p> <ul style="list-style-type: none"> ► Remove the SmartKey and reinsert it into the ignition lock. ► Check the starter battery and charge it if necessary (▷ page 240). ► Start the engine. <p>The on-board voltage is too low.</p> <ul style="list-style-type: none"> ► Switch off nonessential consumers, such as seat heating or interior lighting, and try to turn the SmartKey again. <p>If this does not work:</p> <ul style="list-style-type: none"> ► Check the starter battery and charge it if necessary (▷ page 240). <p>or</p> <ul style="list-style-type: none"> ► Jump-start the vehicle (▷ page 243). <p>or</p> <ul style="list-style-type: none"> ► Consult a qualified specialist workshop.

Doors

Important safety notes

WARNING

When leaving the vehicle, always remove the SmartKey from the ignition lock. Always take the SmartKey with you and lock the vehicle. Do not leave children unsupervised in the vehicle, even if they are secured in a child restraint system, and do not give them access to an unlocked vehicle. A child's unsupervised access to a vehicle could result in an accident and/or serious personal injury. They could:

- injure themselves on vehicle parts
- be seriously or fatally injured by extreme heat or cold
- injure themselves or have an accident with vehicle equipment that may still be in operation even after the SmartKey has been removed from the ignition, such as the seat adjustment, steering wheel adjustment or memory function.

If children open a door, they could cause severe or even fatal injury to other persons; if they get out of the vehicle, they could injure themselves when doing so or be seriously or even fatally injured by any passing traffic.

Do not expose the child restraint system to direct sunlight. The child restraint system's metal parts, for example, could become very hot, and a child could be burned on these parts.

WARNING

Do not carry heavy or hard objects in the passenger compartment or trunk unless they are firmly secured in place.

Unsecured or improperly positioned cargo increases a child's risk of injury in the event of

- strong braking maneuvers
- sudden changes of direction
- an accident

Unlocking and opening the doors from the outside

Coupe

 The doors swing upwards and out when opened. Therefore, make sure that there is sufficient clearance above the vehicle.

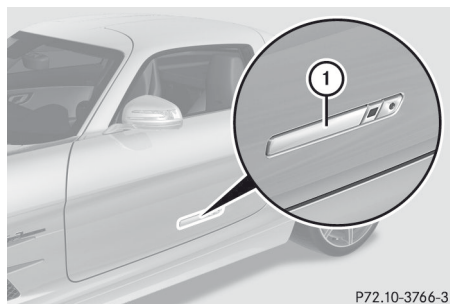

- ▶ Point the SmartKey towards door handle ①.
- ▶ Press the  button on the SmartKey. Door handle ① moves out.
- ▶ Lift the door by door handle ① and swing it up as far as it will go.

Closing the door

- ▶ Pull the door downwards by the outer edge or the interior door handle. Swing the door down gently and allow it to engage in the lower position.
- ▶ Lock the vehicle with the SmartKey if necessary (▷ page 64).

Roadster

- ▶ Point the SmartKey towards the door handle.
- ▶ Press the  button on the SmartKey. The door is unlocked and can be opened.
- ▶ Pull the door handle.

Unlocking and opening doors from inside

Coupe

You can only open a door from the inside if it is unlocked.

The vehicle locks the doors automatically, when you drive faster than 9 mph (15 km/h).

The doors are automatically unlocked after a journey if you switch off the engine.

! The doors swing upwards and out when opened. Therefore, make sure that there is sufficient clearance above the vehicle.

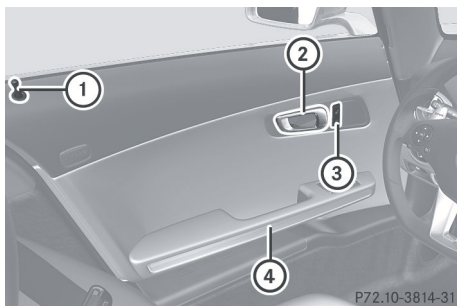

► **To unlock the door manually:** press the  button of central locking ③.

or

► Pull locking knob ① upwards.

► **To open the door:** pull handle ②.

► Swing the door upwards as far as it will go.

► **To close the door:** pull the door down by handle ④.

► Allow the door to engage in the lower position.

► **To lock the door manually:** press the  button of central locking ③.

or

► Push locking knob ① downwards.

Roadster

You can open a door from inside the vehicle even if it has been locked.

Only open the door when the traffic situation permits.

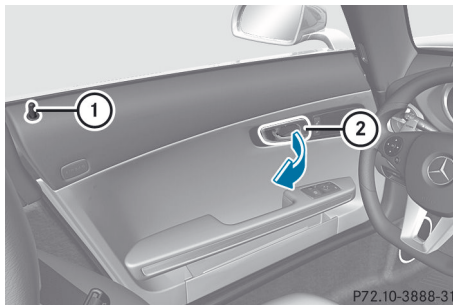

► Pull door handle ②.

If the door is locked, locking knob ① pops up. The door is unlocked and can be opened.

i When a door is opened, the side window on that side opens slightly. When the door is closed, the side window closes again.

! The side windows will not open/close if the battery is discharged or if the side windows have iced up. It will then not be possible to close the door. Do not attempt to force the door closed. You could otherwise damage the door or the side window.

Centrally locking and unlocking the vehicle from the inside (Roadster)

You can centrally lock or unlock the vehicle from the inside. This feature may be useful if, for example, you wish to unlock the front-passenger door from the inside or lock the vehicle before you pull away.

The central locking/unlocking button does not lock or unlock the fuel filler flap.

The central locking/unlocking button does not lock or unlock the fuel filler flap or the stowage compartments, such as the glove box.

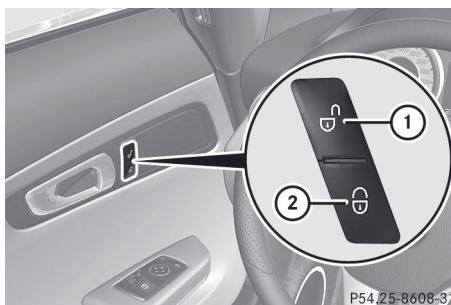
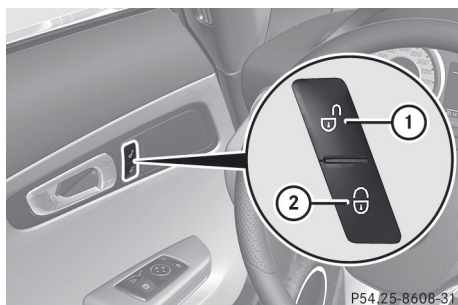

- ▶ **To lock:** press button ②.

If both doors are closed, the vehicle locks.

- ▶ **To unlock:** press button ①.

You can open a door from inside the vehicle even if it has been locked. Only open the door when the traffic situation permits.

If the vehicle has been locked with the central locking button:

- and the SmartKey is set to its factory setting, the entire vehicle is unlocked if a door is opened from the inside
- and the SmartKey is set to an individual setting, only the door that is opened from inside the vehicle is unlocked.

Automatic locking mechanism (Roadster)

You can only open a door from the inside if it is unlocked.

The vehicle locks the doors automatically if you drive faster than 15 km/h.

The doors are automatically unlocked after a journey if you switch off the engine.

The vehicle locks automatically when the ignition is switched on and the wheels of the vehicle are moving at a speed of more than 9 mph (15 km/h). There is therefore a risk of being locked out when the vehicle is being pushed, towed or tested on a dynamometer.

- ▶ **To deactivate:** press and hold button ① for about five seconds until a tone sounds.

- ▶ **To activate:** press and hold button ② for about five seconds until a tone sounds.

- ❗ If you press one of the two buttons and do not hear a tone, the relevant setting has already been selected.

You can also switch the automatic locking function on and off using the on-board computer (▷ page 159).

Unlocking the driver's door (mechanical key)

If the vehicle can no longer be unlocked with the SmartKey, use the mechanical key.

If you use the mechanical key to unlock and open the driver's door, the anti-theft alarm system will be triggered (▷ page 59).

- ▶ Take the mechanical key out of the SmartKey (▷ page 65).
- ▶ Insert the mechanical key into the lock of the driver's door as far as it will go.

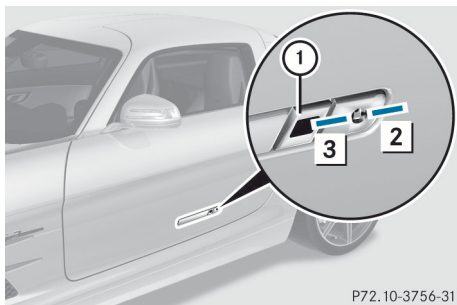
Coupe

- ▶ **To unlock:** insert the mechanical key into the lock of the driver's door as far as it will go.
- ▶ Turn the mechanical key clockwise to position **2**.
The door is unlocked.
- ▶ Turn the mechanical key back and remove it.
- ▶ **To open the door:** press button **1**.
The handle moves out slightly from the door.
- ▶ Pull the handle out as far as it will go.
- ▶ Swing the door upwards by the handle.

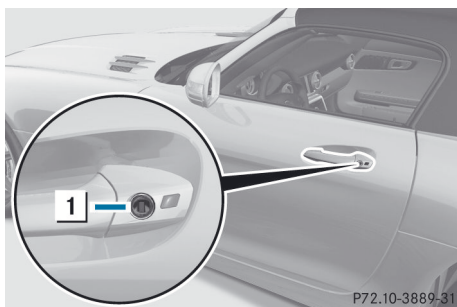
Roadster

- ▶ Turn the mechanical key counterclockwise to position **1**.
The door is unlocked.
- ▶ Turn the mechanical key back and remove it.
- ▶ Insert the mechanical key into the SmartKey.

Locking the vehicle (mechanical key)**Coupe**

If the vehicle can no longer be locked with the SmartKey, use the mechanical key.

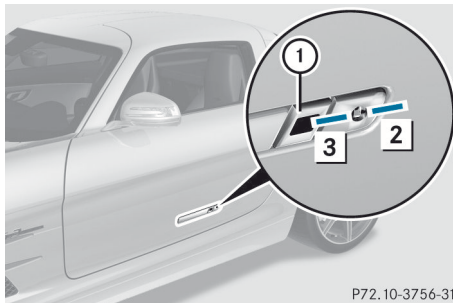

- ▶ **To lock:** lock the front-passenger door manually from the inside (▷ page 70).
- ▶ Leave the vehicle and close the driver's door.
- ▶ Insert the mechanical key into the lock of the driver's door as far as it will go.
- ▶ Turn the mechanical key counter-clockwise to position **3**.
The door is locked.
- ▶ Turn the mechanical key back and remove it.
- ▶ Check that both doors are locked.

i If you lock the vehicle as described above, the fuel filler flap is not locked. The anti-theft alarm system is not armed.

Roadster

If the vehicle can no longer be locked with the SmartKey, use the mechanical key.

- ▶ Open the driver's door.
- ▶ Close the front-passenger door and the trunk lid.
- ▶ Press the locking button (▷ page 70).
- ▶ Check that the locking knob is in the lower position on the front-passenger door. Press down the locking knob by hand, if necessary.
- ▶ Close the driver's door.

- ▶ Take the mechanical key out of the SmartKey (▷ page 65).
- ▶ Insert the mechanical key into the lock of the driver's door as far as it will go.

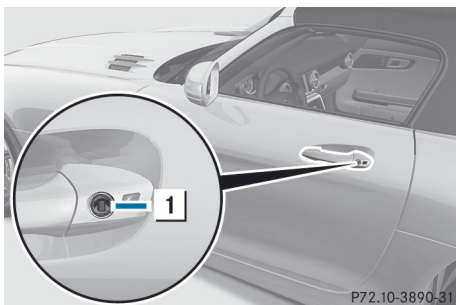

- ▶ Turn the mechanical key clockwise as far as it will go to position **1**.
- ▶ Turn the mechanical key back and remove it.
- ▶ Make sure that the doors and the trunk lid are locked.
- ▶ Insert the mechanical key into the SmartKey.

i If you lock the vehicle as described above, the fuel filler flap is not locked. The anti-theft alarm system is not armed.

Trunk

Important safety notes

⚠ WARNING

When leaving the vehicle, always remove the SmartKey from the ignition lock. Always take the SmartKey with you and lock the vehicle. Do not leave children unsupervised in the vehicle, even if they are secured in a child restraint system, and do not give them access to an unlocked vehicle. A child's unsupervised access to a vehicle could result in an accident and/or serious personal injury. They could:

- injure themselves on vehicle parts
- be seriously or fatally injured by extreme heat or cold
- injure themselves or have an accident with vehicle equipment that may still be in operation even after the SmartKey has been removed from the ignition, such as the seat adjustment, steering wheel adjustment or memory function.

If children open a door, they could cause severe or even fatal injury to other persons; if they get out of the vehicle, they could injure themselves when doing so or be seriously or even fatally injured by any passing traffic.

Do not expose the child restraint system to direct sunlight. The child restraint system's metal parts, for example, could become very hot, and a child could be burned on these parts.

⚠ WARNING

Make sure the trunk lid is closed when the engine is running and while driving. Among other dangers, deadly carbon monoxide (CO) gases may enter the vehicle interior resulting in unconsciousness and death.

- !** The temperature in the trunk may be high. For this reason, do not store any temperature-sensitive objects in the trunk.

! The trunk lid swings upwards when opened. Therefore, make sure that there is sufficient clearance above the trunk lid.

Coupe: to open the trunk lid fully, a minimum clearance of 5.5 ft (1.68 m) from the ground is required.

Roadster: to open the trunk lid fully, a minimum clearance of 5.7 ft (1.75 m) from the ground is required.

The trunk lid can be:

- opened automatically from outside
- opened automatically from inside
- locked separately
- unlocked with the mechanical key
- opened with the emergency release button

Opening/closing the trunk

Opening and closing from outside the vehicle

Opening

- ▶ Press the  button on the SmartKey. The trunk lid opens slightly.





- ▶ Reach into the gap and pull up the trunk lid.

Closing

WARNING

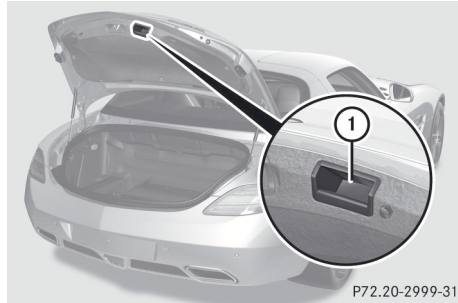
To prevent possible personal injury, always keep hands and fingers away from the trunk opening when closing the trunk lid. Be especially careful when small children are around.



- ▶ Push the trunk lid down until it engages. Use handle ① to pull down the trunk lid if necessary.
- ▶ If necessary, lock the vehicle with the  button on the SmartKey.

Opening from inside the vehicle

You can open the tailgate from the driver's seat when the vehicle is stationary.



- ▶ Press trunk lid remote control button ①. The trunk lid opens slightly.

Locking the trunk separately

You can lock the trunk separately. If you then unlock the vehicle centrally, the trunk remains locked and cannot be opened.

- ▶ Close the trunk lid.
- ▶ Take the mechanical key out of the SmartKey (> page 65).

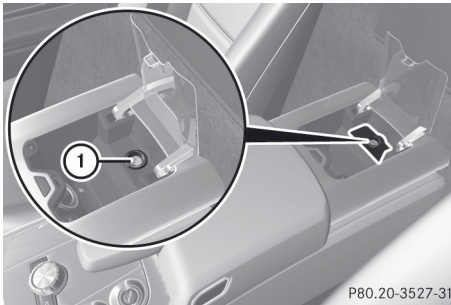

P80.20-3527-31

- ▶ Insert the mechanical key fully into trunk lid lock ① in the rear compartment of the center console.
- ▶ Turn the mechanical key clockwise as far as possible.
- ▶ Remove the mechanical key.
- ▶ Check that the trunk remains locked when you press on the trunk lid remote control button.

Unlocking the trunk (mechanical key)

If the trunk can no longer be unlocked with the SmartKey:

- ▶ Take the mechanical key out of the SmartKey (▷ page 65).

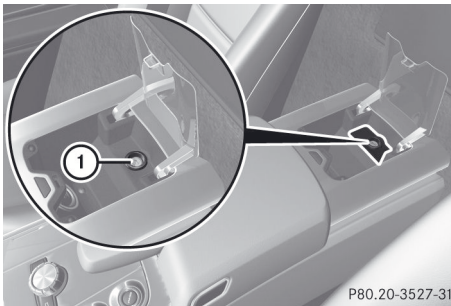

P80.20-3527-31

- ▶ Insert the mechanical key fully into trunk lid lock ① in the center console in the vehicle interior.
- ▶ Turn the mechanical key counter-clockwise as far as possible.
The trunk lid opens slightly.

Trunk emergency release

You can open the trunk lid from inside the vehicle with the emergency release button.

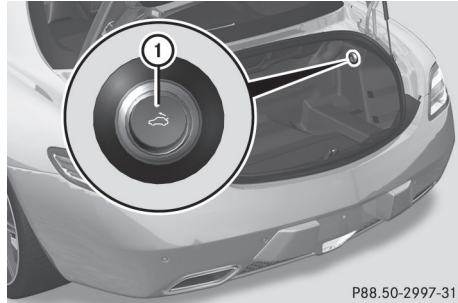

P88.50-2997-31

- ▶ Briefly press emergency release button ①.
The trunk lid unlocks and opens slightly.
- ▶ Push the trunk lid upwards to open it completely.

The trunk lid can be unlocked with the trunk lid emergency release when the vehicle is stationary or while driving.

Trunk lid emergency release light:

- emergency release button ① flashes for 30 minutes after the trunk lid is opened.
- emergency release button ① flashes for 60 minutes after the trunk lid is closed.

The trunk lid emergency release does not unlock the trunk lid if the battery is disconnected or discharged.

If the vehicle was locked centrally, opening the trunk lid with the trunk lid emergency release triggers the anti-theft alarm system.

Side windows

Important safety notes

WARNING

When opening and closing the side windows, make sure that nobody can be injured by the opening or closing procedure.

The side windows are equipped with automatic operation and anti-entrapment

features. If, in automatic operation mode, a side window encounters an obstruction that blocks its path, the anti-entrapment feature will stop the side window and open it slightly.

The side windows operate differently when the switch is pulled and held. These details can be found in the "Closing a blocked side window" section in this chapter.

The closing of the side windows can be immediately halted by releasing the switch or, if the switch was pulled past the resistance point and released, by pressing or pulling the respective switch.

If a side window encounters an obstruction that blocks its path when you are closing the side windows by pressing and holding the  button on the SmartKey, the anti-entrapment feature will not operate.

WARNING

Do not keep any part of your body up against the window pane when opening a window. The downward motion of the pane may pull that part of your body down between the window pane and the door frame and trap it there. If there is a risk of entrapment, release the switch and pull it to close the window.

Observe the important safety notes in the "Children in the vehicle" section (▷ page 51).

Opening and closing the side windows

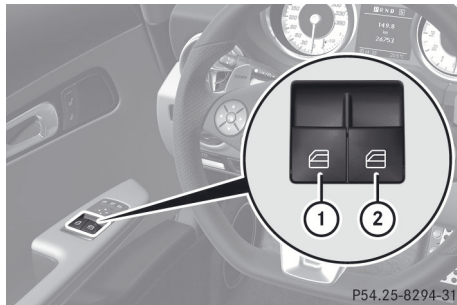

- ① Left
- ② Right

The switches for both side windows are located on the driver's door. There is also a switch for the front-passenger side window on the front-passenger door.

The switches on the driver's door take precedence.

▶ Select key position **2** using the Start/Stop button.

▶ **To open:** press the corresponding switch.

▶ **To close:** pull the corresponding switch.

i If you press the switch beyond the point of resistance, an automatic opening/closing process is started in the corresponding direction. You can stop automatic operation by operating the switch again.

i You can continue to operate the side windows after you switch off the engine. This function is available for up to five minutes or until the driver's or front-passenger door is opened.



Opening and closing all side windows (Roadster)

With the SmartKey





WARNING

Make sure that nobody can become trapped as you close the side windows.

Proceed as follows if there is a risk of entrapment:

- release the  button.
- press and hold the  button until the side windows open again.

If the soft top is closed, you can use the SmartKey to simultaneously open or close all of the side windows:



- ▶ Make sure that the soft top is closed (> page 78).
- ▶ Point the tip of the SmartKey at the driver's door handle.
- ▶ **To open all side windows:** press and hold the  button on the SmartKey until the side windows are fully open.
- ▶ **To interrupt the opening procedure:** release the  button.
- ▶ **To close all side windows:** press and hold the  button on the SmartKey until the side windows are fully closed.
- ▶ **To interrupt the closing procedure:** release the  button.

Convenience opening (Coupe)

WARNING

When closing the side windows, make sure there is no danger of anyone being harmed by the closing procedure.



Proceed as follows in a potentially dangerous situation:

- Release the  button to interrupt the closing procedure.
- Press and hold the  button to open. To continue the closing procedure after

ensuring that nobody can be injured by the closing procedure, press and hold the



 button.

When you lock the vehicle, you can simultaneously close both side windows from outside.

- i** The SmartKey must be close to the driver's door handle.
- ▶ Point the tip of the SmartKey at the driver's door handle.
- ▶ Lock the vehicle with the  button.
- ▶ Press and hold the  button until the side windows are fully closed.
- ▶ Make sure that all the side windows are closed.

Convenience closing (Coupe)

You can ventilate the vehicle before you start driving. To do so, open the side windows using the SmartKey.

- i** The SmartKey must be close to the driver's door handle.
- ▶ Point the tip of the SmartKey at the driver's door handle.
- ▶ Unlock the vehicle by pressing the  button.
- ▶ Press and hold the  button until the side windows are in the desired position.
- ▶ **To interrupt convenience opening:** release the  button.

Problems with the side windows

Problem: a side window cannot be closed because objects are preventing it from closing.

- ▶ Remove the objects.
- ▶ Close the side window.

Problem: a side window cannot be closed and you cannot see the cause.

⚠ WARNING

Closing the side windows with increased force or without the anti-entrapment feature could lead to serious or even fatal injury. Make sure that nobody can become trapped when closing the side windows.

If a side window is obstructed during closing and reopens again slightly:

- ▶ Immediately after the window blocks, pull the corresponding switch again until the side window has closed.
The side window is closed with increased force.

If a side window is obstructed again during closing and reopens again slightly:

- ▶ Immediately after the window blocks, pull the corresponding switch again until the side window has closed.
The side window is closed without the anti-entrapment feature.

⚠ WARNING

Pulling and holding the switch to close the door window immediately after it had been blocked two times will cause the door window to close without the anti-entrapment feature for as long as you hold the switch.

Soft top (Roadster)**Important safety notes****⚠ WARNING**

Only drive with the soft top fully open or closed.

If the soft top does not open or close fully, the soft-top hydraulics are depressurized and the soft top is lowered:

- after about seven minutes if the ignition is switched on
- immediately if the ignition is switched off

A warning tone sounds shortly beforehand. The **Top lowering** message appears in the multifunction display..

Lock the soft top again before driving on. Otherwise the unlocked soft top could open during the journey and cause you to lose control of your vehicle. You and/or other persons could be injured as a result.

You can open or close the soft top:

- if the vehicle is stationary or
- if the speed does not exceed 30 mph (50 km/h)

If there is a strong head wind, it may not be possible to close the soft top fully. In this case, reduce speed or stop in order to close the soft top fully.

For safety reasons, Mercedes-Benz recommends that you only open or close the soft top when the vehicle is stationary.

! Never sit on the soft top when it is closed or store heavy objects on it. You will otherwise damage the soft top of the vehicle.

! When opening and closing the soft top, make sure that:

- there is sufficient clearance above it, as the soft top swings upwards.
- there are no objects on the soft top or the soft-top covers to the side.
- the fabric is not dirty, wet or frozen
- the outside temperature is above -10 °C.

You could otherwise damage the soft top as well as other parts of the vehicle.

i Make sure that the soft top is dry and clean before closing it. Otherwise, water or dirt could enter the vehicle interior or trunk.

Opening and closing with the soft top switch**Important safety notes****⚠ WARNING**

Make sure nobody can be trapped or injured by moving parts, such as the soft-top linkage

or soft-top compartment cover, when opening or closing the soft top.

Release the soft-top switch in the event of danger. The soft-top mechanism stops immediately.

WARNING

The soft top stops moving during the opening or closing procedure if you drive faster than 30 mph (50 km/h). This could impair your rear view. At high speeds the soft top may be damaged.

Reduce your speed to below 30 mph (50 km/h) or stop in accordance with traffic conditions. Press the soft-top switch again in order to open or close the soft top fully.

Opening and closing

- ▶ When the vehicle is stationary, depress the brake pedal.
- ▶ Select key position 1 using the Start/Stop button.

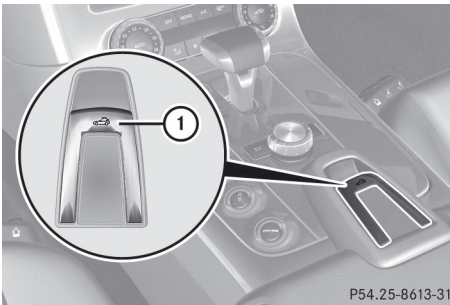

- ▶ **To open:** pull soft-top switch ① until the soft top is fully opened. The **Convertible Top in Operation** message appears in the multifunction display. If you drive faster than 30 mph (50 km/h) during the opening procedure, the opening procedure is stopped and the **Open/Close Convertible Top Completely** message is displayed in the multifunction display. Reduce speed back to under

30 mph (50 km/h) and pull the soft top switch again to fully open the soft top.

- ▶ **To close:** press and hold soft-top switch ① until the soft top is fully closed. The **Convertible Top in Operation** message appears in the multifunction display.



If you drive faster than 30 mph (50 km/h) during the closing procedure, the closing procedure is stopped and the **Open/Close Convertible Top Completely** message is displayed in the multifunction display. Reduce speed back to under 30 mph (50 km/h) and push the soft top switch again to fully close the soft top.

Opening and closing using the SmartKey

Important safety notes



WARNING

Make sure nobody can be trapped or injured by moving parts, such as the soft-top linkage or soft-top compartment cover, when opening or closing the soft top.

If there is a risk of entrapment, immediately release the  or  button on the SmartKey. The soft-top mechanism stops immediately.

Opening and closing

- ① The SmartKey must be close to the driver's door handle.

- ▶ Point the tip of the SmartKey at the driver's door handle.
- ▶ **To open:** press and hold the  button on the SmartKey until the soft top is fully opened.
The **Convertible Top in Operation** message appears in the multifunction display.
- ▶ **To close:** press and hold the  button on the SmartKey until the soft top is fully closed.
The **Convertible Top in Operation** message appears in the multifunction display. The soft top and the side windows close.

Re-locking the soft top

WARNING

Stop the vehicle at a suitable location as soon as it is possible to do so safely and lock the soft top before driving on. You could otherwise endanger yourself and others.

The soft top is not locked if:

- the **Convertible Top in Operation** message appears in the multifunction display.
- you hear a warning tone for up to ten seconds when pulling away or while driving.

You can lock the soft top again if it is not locked fully.

- ▶ Stop the vehicle immediately, paying attention to road and traffic conditions.
- ▶ Select key position **2** using the Start/Stop button.
- ▶ Press the soft-top switch.

Installing/removing the wind screen

WARNING

You could lose control of the vehicle and injure yourself or others if you operate the wind screen while driving.

Install or remove the wind screen only when the vehicle is stationary.

WARNING

If the wind screen is not properly engaged and the fastening levers are not folded outwards, it could become detached while driving. There is a risk of accident and injury.

Make sure that you push in the wind screen up to the locking point and then fold the fastening levers outwards.

- ❗ Install or remove the wind screen only when the soft top is open. You could otherwise damage the wind screen or the vehicle interior.

- ❗ Mercedes-Benz recommends that you only use wind screens which have been tested and approved for Mercedes-Benz vehicles. This helps to prevent damage to the vehicle.

The wind screen protects against wind when driving with the soft top open. It is secured between the roll bars.

The wind screen is located in a bag on the tank partition wall in the trunk.

- ▶ Open the trunk.

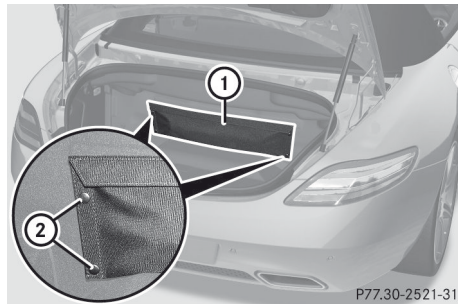

- ▶ Detach wind screen bag **1** from the four press-studs **2** on the tank partition wall.
- ▶ Remove the wind screen from the bag and attach the bag to the tank partition wall again.

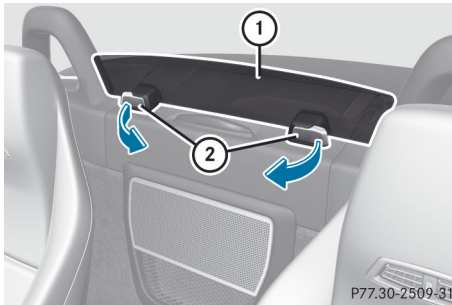

- ▶ **To install:** fold both fastening levers ② inwards.
- ▶ Push wind screen ① into the recess between the roll bars up to the locking point.
- ▶ Fold both fastening levers ② outwards.
- ▶ **To remove:** fold both fastening levers ② inwards in the direction of the arrow.
- ▶ Pull wind screen ① upward.
- ▶ Detach the wind screen bag, remove it from the trunk and put the wind screen back into it.
- ▶ Attach the wind screen bag to the tank partition wall in the trunk again.

Problems with the soft top

Problem	Possible causes/consequences and ► Solutions
The soft top will not open or close.	Key position 1 is not selected. ► Select key position 1 using the Start/Stop button.
	The brake pedal has not been depressed with the vehicle stationary. ► Depress the brake pedal.
	The soft-top mechanism or control system is defective. ► Visit a qualified specialist workshop.
	The soft top was opened and closed several times in succession. The soft-top drive has been deactivated automatically for safety reasons. You can open or close the soft top again after approximately ten minutes. ► Switch the ignition off and then on again. ► Repeat the opening or closing procedure.

Useful information	84
Correcting the driver's seat position	84
Seats	85
Steering wheel	88
Mirrors	89
Memory function	91

Useful information

- i** This Operator's Manual describes all models and all standard and optional equipment of your vehicle available at the time of publication of the Operator's Manual. Country-specific differences are possible. Please note that your vehicle may not be equipped with all features described. This also applies to safety-related systems and functions.
- i** Please read the information on qualified specialist workshops (▷ page 21).

Correcting the driver's seat position



Observe the safety guidelines on seat adjustment (▷ page 85).

- ▶ Check whether you have adjusted seat ③ properly.

Electrical seat adjustment (▷ page 86)

When adjusting the seat, make sure that:

- you are as far away from the driver's air bag as possible.
- you are sitting in a normal upright position.
- you can fasten the seat belt properly.
- you have moved the backrest to an almost vertical position.
- you have set the seat cushion angle so that your thighs are gently supported.
- you can depress the pedals properly.

Observe the safety guidelines on steering wheel adjustment (▷ page 88).

- ▶ Check whether steering wheel ① is adjusted properly.

Adjusting the steering wheel electrically (▷ page 88)

When adjusting the steering wheel, make sure that:

- you can hold the steering wheel with your arms slightly bent.
- you can move your legs freely.
- you can see all the displays in the instrument cluster clearly.

Observe the safety guidelines for seat belts (▷ page 47).

- ▶ Check whether you have fastened seat belt ② properly (▷ page 49).

The seat belt should:

- fit snugly across your body
 - be routed across the middle of your shoulder
 - be routed in your pelvic area across the hip joints
- ▶ Before starting off, adjust the rear-view mirror and the exterior mirrors (▷ page 89) in such a way that you have a good view of road and traffic conditions.
 - ▶ **Vehicles with a memory function:** save the seat, steering wheel and exterior mirror settings (▷ page 91).

Seats

Important safety notes

WARNING

In order to avoid possible loss of vehicle control, the following must be done before the vehicle is put into motion:

- seat adjustment
- steering wheel adjustment
- rear-view mirror adjustment
- fastening of seat belts

WARNING

In order to avoid possible loss of vehicle control, all seat, head restraint, steering wheel and rear view mirror adjustments, as well as fastening of seat belts, must be done before setting the vehicle in motion.

WARNING

Do not adjust the driver's seat while driving. Adjusting the seat while driving could cause the driver to lose control of the vehicle.

Never travel in a moving vehicle with the seat backrest in an excessively reclined position as this can be dangerous. You could slide under the seat belt in a collision. If you slide under it, the seat belt would apply force at the abdomen or neck. This could cause serious or fatal injuries. The seat backrest and seat belts provide the best restraint when the wearer is in a position that is as upright as possible and seat belts are properly positioned on the body.

WARNING

Your seat belt must be adjusted so that you can correctly fasten your seat belt.

Observe the following points:

- adjust the seat backrest until your arms are slightly angled when holding the steering wheel.
- adjust the seat to a comfortable seating position that still allows you to reach the

accelerator/brake pedal safely. The position should be as far back as possible with the driver still able to operate the controls properly.

- adjust the head restraint so that it is as close to the head as possible and the center of the head restraint supports the back of the head at eye level.
- never place hands under the seat or near any moving parts while a seat is being adjusted.

Failure to do so could result in an accident and/or serious personal injury.

WARNING

The electrically adjustable seats can be operated at any time. Therefore, do not leave children unattended in the vehicle, or with access to an unlocked vehicle. A child's unsupervised access to a vehicle could result in an accident and/or serious personal injury.

WARNING

Children 12 years old and under must be seated and properly secured in an appropriately sized infant restraint, toddler restraint or booster seat recommended for the size and weight of the child. For additional information, see section "Children in the vehicle".

A child's risk of serious or fatal injuries is significantly increased if the child restraints are not properly secured in the vehicle and/or the child is not properly secured in the child restraint.

 To avoid damage to the seats and the seat heating, observe the following information:

- do not spill any liquids on the seats. If liquid is spilled on the seats, dry them as soon as possible.
- if the seat covers are damp or wet, do not switch on the seat heating. The seat heating should also not to be used to dry the seats.

- clean the seat covers as recommended; see the "Interior care" section.
- do not transport heavy loads on the seats. Do not place sharp objects on the seat cushions, e.g. knives, nails or tools. The seats should only be occupied by passengers, if possible.
- when the seat heating is in operation, do not cover the seats with insulating materials, e.g. blankets, coats, bags, seat covers, child seats or booster seats.

! When you move the seats, make sure that there are no objects in the footwell or behind the seats. Otherwise, you could damage the seats and the objects.

Adjusting the seats

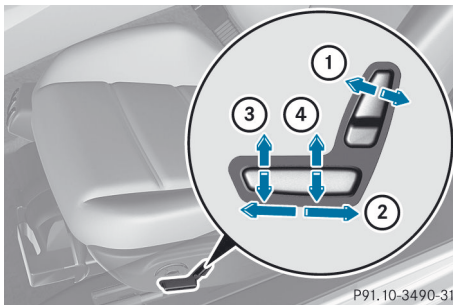

- ① Backrest angle
 - ② Seat fore-and-aft adjustment
 - ③ Seat cushion angle
 - ④ Seat height
- i** You can store the seat settings using the memory function (▷ page 91).

Adjusting the lumbar support

You can adjust the contour of the seat so as to provide optimum support for your back.

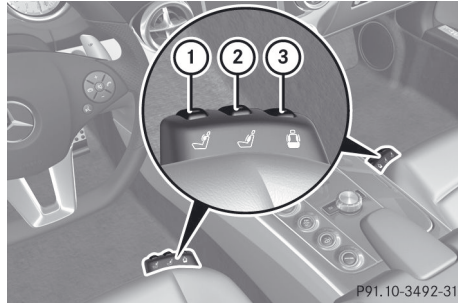

- ① To adjust the upper back support
- ② To adjust the contour of the backrest in the lumbar region
- ③ To adjust the lateral structure and support of the seat

► Select key position **2** with the Start/Stop button.

- i** If, after a certain amount of time, the seat no longer has the desired contour, repeat the adjustment.

Switching the seat heating on/off

Switching on/off

! WARNING

Repeatedly setting the seat heating to level **3** may result in excessive seat temperatures. The health of passengers that have limited temperature sensitivity or a limited ability to react to excessively high temperatures may be affected or they may even suffer burn-like injuries. Therefore, do not use seat heating level **3** repeatedly.

The three red indicator lamps in the button indicate the heating level you have selected.

- i** If the battery voltage is too low, the seat heating may switch off.



The system automatically switches down from level **3** to level **2** after approximately five minutes.

The system automatically switches down from level **2** to level **1** after approximately ten minutes.

The system automatically switches off approximately 20 minutes after it is set to level **1**.

- ▶ Select key position **2** with the Start/Stop button.
- ▶ **To switch on:** press button ① repeatedly until the desired heating level is set.
- ▶ **To switch off:** press button ① repeatedly until all the indicator lamps go out.

Problems with the seat heating

The seat heating has switched off prematurely or cannot be switched on. The vehicle's electrical system voltage is too low because too many electrical consumers are switched on.

- ▶ Switch off electrical consumers that you do not need, such as the rear window defroster or interior lighting. Once the battery is sufficiently charged, the seat heating will switch back on automatically.

AIRSCARF (Roadster)

⚠ WARNING

Very hot air can flow out of the AIRSCARF vents in the head restraints when AIRSCARF is in operation. This can cause burns on unprotected skin near the AIRSCARF vents. Make sure that you reduce the heater output in time.

The AIRSCARF function warms the head and neck area of vehicle occupants with warm air. The warm air flows out of the holes in the head restraints.

The three red indicator lamps in the button indicate the heating level you have selected.

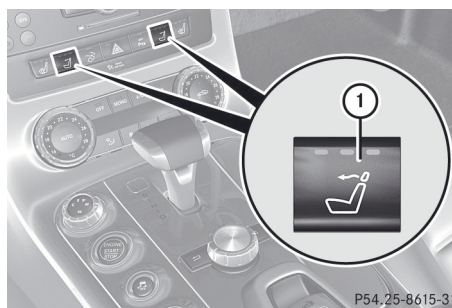

- ▶ Make sure that the SmartKey is in position **2** in the ignition lock.
- ▶ **To activate:** press button ①. Three red indicator lamps in the button light up. The blower starts up after a preheating phase of seven seconds.
- ▶ Press button ① repeatedly until the desired heating level is set.
- ▶ **To switch off:** press button ① repeatedly until all the indicator lamps go out.

You can use the adjustable fins on the head restraint to adjust the height of the current of air blown out according to your height.

Make sure that there are no objects covering the intake grille on the back of the driver's seat backrest.

- ① The blower continues running for seven seconds to cool down the heating elements.

- i** If the battery voltage is too low, AIRSCARF may switch off.

Steering wheel

Important safety notes

⚠ WARNING

Do not adjust the steering wheel while driving. Adjusting the steering wheel while driving could cause the driver to lose control of the vehicle.

The electrical steering wheel adjustment feature can be operated at any time. Therefore, do not leave children unattended in the vehicle, or with access to an unlocked vehicle. A child's unsupervised access to a vehicle could result in an accident and/or serious personal injury.

Adjusting the steering wheel

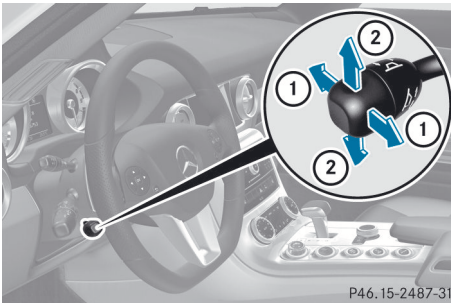

- ① To adjust the steering wheel position (fore-and-aft adjustment)
- ② To adjust the steering wheel height
- i** Other topics:
- EASY-ENTRY/EXIT feature (▷ page 88)
 - Storing settings (▷ page 91)

EASY-ENTRY/EXIT system

Important safety notes

The EASY-ENTRY/EXIT feature makes getting in and out of your vehicle easier.

You can activate and deactivate the EASY-ENTRY/EXIT feature in the on-board computer (▷ page 159).

⚠ WARNING

You must make sure no one can become trapped or injured by the moving steering wheel when the easy-entry/exit feature is activated.

To stop steering wheel movement, move steering wheel adjustment stalk or press the memory position switch.

Do not leave children unattended in the vehicle, or with access to an unlocked vehicle. Children could open the driver's door and unintentionally activate the easy-entry/exit feature, which could result in an accident and/or serious personal injury.

⚠ WARNING

Let the system complete the adjustment procedure before setting the vehicle in motion. All steering wheel adjustment must be completed before setting the vehicle in motion. Driving off with the steering wheel still adjusting could cause the driver to lose control of the vehicle.

Position of the steering wheel when the EASY-ENTRY/EXIT feature is active

The steering wheel swings upwards when you:

- remove the SmartKey from the ignition lock
- open the driver's door with the KEYLESS-GO start function in position **1**
- open the driver's door and the SmartKey is in position **0** or **1** in the ignition lock

- i** The steering wheel only moves upwards if it has not already reached the upper end stop.

Position of the steering wheel for driving

The steering wheel is moved to the last selected position when:

- the driver's door is closed.
- you press the Start/Stop button once.

When you close the driver's door with the ignition switched on, the steering wheel is also automatically moved to the previously set position.

The last position of the steering wheel is stored after each manual setting or when you store the setting with the memory function (▷ page 91).

Crash-responsive EASY-EXIT feature

If the crash-responsive EASY-EXIT feature is triggered in an accident, the steering column will move upwards when the driver's door is opened. This occurs irrespective of the position of the SmartKey in the ignition lock. This makes it easier to exit the vehicle and rescue the occupants.

The crash-responsive EASY-EXIT feature is only operational if the EASY-EXIT/ENTRY feature is activated in the on-board computer.

Mirrors

Rear-view mirror

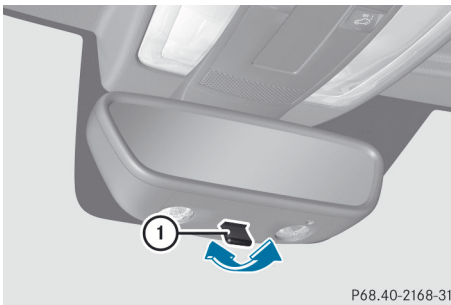

P68.40-2168-31

- ▶ **Anti-glare mode:** flick anti-glare switch ① forwards or back.

Exterior mirrors

Adjusting the exterior mirrors

WARNING

Exercise care when using the passenger-side exterior rear view mirror. The mirror surface is convex (outwardly curved surface for a wider field of view). Objects in mirror are closer than they appear. Check your interior rear view mirror and glance over your shoulder before changing lanes.

The convex exterior mirrors provide a larger field of vision.

The exterior mirrors are automatically heated if the rear window defroster is switched on and the outside temperature is low.

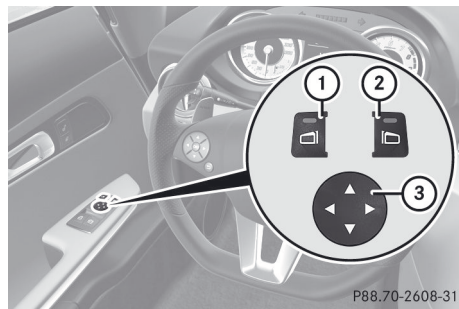

P88.70-2608-31

- ▶ Select key position 1 or 2 with the Start/Stop button.
- ▶ Press button ① for the left-hand exterior mirror or button ② for the right-hand exterior mirror. The indicator lamp in the corresponding button lights up in red. The indicator lamp goes out again after some time. You can adjust the selected mirror using adjustment button ③ as long as the indicator lamp is lit.
- ▶ Press adjustment button ③ up, down, to the right or to the left until the exterior mirror is set to a position that provides you with a good overview of traffic conditions.

Folding the exterior mirrors in or out electrically

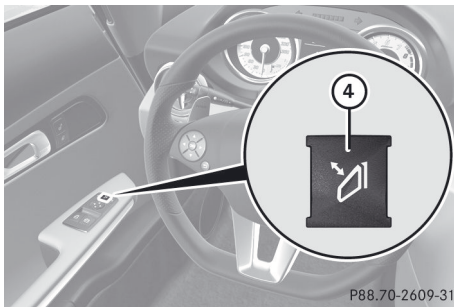

- ▶ Select key position **1** or **2** with the Start/Stop button.
- ▶ Briefly press button ④.
Both exterior mirrors fold in or out.
- i** Make sure that the exterior mirrors are always folded out fully while the vehicle is in motion, as they may otherwise vibrate.
- i** If you are driving faster than 30 mph (47 km/h), you can no longer fold in the exterior mirrors.

Setting the exterior mirrors

If the battery has been disconnected or completely discharged, the exterior mirrors must be reset. The exterior mirrors will otherwise not fold in when you select the "Fold in mirrors when locking" function in the on-board computer (▷ page 160).

- ▶ Select key position **1** with the Start/Stop button.
- ▶ Briefly press button ④.

Folding the exterior mirrors in or out automatically

If the "Fold in mirrors when locking" function is activated in the on-board computer (▷ page 160):

- the exterior mirrors fold in automatically as soon as you lock the vehicle from the outside.
 - the exterior mirrors fold out again automatically as soon as you unlock the vehicle and then open the driver's or front-passenger door.
- i** The mirrors do not fold out if they have been folded in manually.

Exterior mirror out of position

If an exterior mirror has been pushed out of position, proceed as follows:

- ▶ **Vehicles without electrically folding exterior mirrors:** move the exterior mirror into the correct position manually.
- ▶ **Vehicles with electrically folding exterior mirrors:** press the mirror-folding button (▷ page 90) repeatedly until you hear the mirror engage in position. The mirror housing is engaged again and you can adjust the exterior mirrors as usual (▷ page 89).

Automatic anti-glare mirrors

⚠ WARNING

If incident light from headlamps is prevented from striking the sensor in the rear-view mirror, for instance, by luggage piled too high in the vehicle, the mirror's automatic anti-glare function will not operate.

Incident light could then blind you. This may distract you from the traffic conditions and, as a result, you may cause an accident.

The rear-view mirror and the exterior mirror on the driver's side automatically go into anti-glare mode if the ignition is switched on and incident light from headlamps strikes the sensor in the rear-view mirror.

The mirrors do not go into anti-glare mode if reverse gear is engaged.

Parking position for the exterior mirror on the front-passenger side

Setting and storing the parking position

You can position the front-passenger side exterior mirror in such a way that you can see the rear wheel on that side as soon as you engage reverse gear. You can store this position.

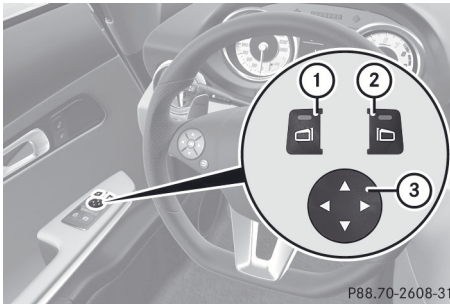

P88.70-2608-31

- ▶ Select key position **2** with the Start/Stop button.
- ▶ Press button **②** for the exterior mirror on the front-passenger side.
- ▶ Engage reverse gear.
The exterior mirror on the front-passenger side moves to the preset parking position.
- ▶ Use adjustment button **③** to adjust the exterior mirror to a position that allows you to see the rear wheel and the curb.
The parking position is stored.

i If you shift the transmission to another position, the exterior mirror on the front-passenger side returns to the driving position.

Calling up a stored parking position setting

- ▶ Select key position **2** with the Start/Stop button.
- ▶ Adjust the exterior mirror on the front-passenger side with the corresponding button (▷ page 89).
- ▶ Engage reverse gear.
The exterior mirror on the front-passenger side moves to the stored parking position.

The exterior mirror on the front-passenger side moves back to its original position:

- as soon as you exceed a speed of 6 mph (10 km/h)
- about ten seconds after you have disengaged reverse gear
- if you press button **①** for the exterior mirror on the driver's side

Memory function

Storing settings

⚠ WARNING

Do not activate the memory function while driving. Activating the memory function while driving could cause the driver to lose control of the vehicle.

With the memory function, you can store up to three different settings, e.g. for three different people.

The following settings are stored as a single memory preset:

- seat and backrest position
- driver's side: steering wheel position
- driver's side: position of the exterior mirrors on the driver's and front-passenger sides

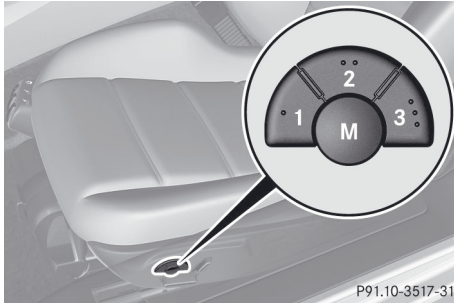

P91.10-3517-31

- ▶ Select key position **2** with the Start/Stop button.
- ▶ Adjust the seat (▷ page 86).
- ▶ On the driver's side, adjust the steering wheel (▷ page 88) and the exterior mirrors (▷ page 89).
- ▶ Press memory button **M** and one of the storage position buttons **1**, **2** or **3** within three seconds.
The settings are stored in the selected preset position. A tone sounds when the settings have been completed.

Calling up a stored setting

- ▶ Press and hold the relevant storage position button **1**, **2** or **3** until the seat, steering wheel and exterior mirrors are in the stored position.
- i** The setting procedure is interrupted as soon as you release the storage position button.

Useful information 94
Exterior lighting 94
Interior lighting 97
Replacing bulbs 98
Windshield wipers 99

Useful information

- i** This Operator's Manual describes all models and all standard and optional equipment of your vehicle available at the time of publication of the Operator's Manual. Country-specific differences are possible. Please note that your vehicle may not be equipped with all features described. This also applies to safety-related systems and functions.
- i** Please read the information on qualified specialist workshops (▷ page 21).

Exterior lighting

Important safety notes

For reasons of safety, Mercedes-Benz recommends that you drive with the lights switched on even during the daytime. In some countries, operation of the headlamps varies due to legal requirements and self-imposed obligations.

Information about driving abroad

Converting to symmetrical low beam when driving abroad: switch the headlamps to symmetrical low beam in countries in which traffic drives on the opposite side of the road to the country where the vehicle is registered. This prevents glare to oncoming traffic. Symmetrical lights do not illuminate as large an area of the edge of the road. Have the headlamps converted at a qualified specialist workshop, e.g. an authorized Mercedes-Benz Center, as close to the border as possible before driving in these countries.

Converting to asymmetrical low beam after returning: have the headlamps converted back to asymmetrical low beam at a qualified specialist workshop, e.g. an authorized Mercedes-Benz Center, as soon as possible after crossing the border again.

Light switch

Operation

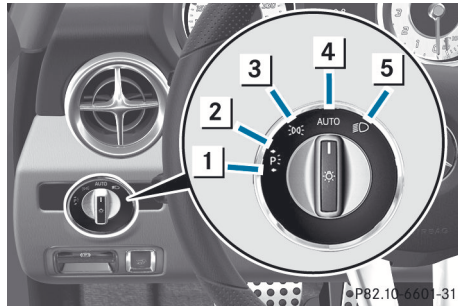

- 1** Left-hand standing lamps
- 2** Right-hand standing lamps
- 3** Parking lamps, license plate and instrument cluster lighting
- 4** **AUTO** Automatic headlamp mode/daytime running lamps
- 5** Low-beam/high-beam headlamps

The turn signals, high-beam headlamps and the high-beam flasher are operated using the combination switch (▷ page 96).

- !** Switch off the parking lamps and standing lamps when you leave the vehicle. This prevents the battery from discharging.



The exterior lighting (except the parking/standing lamps) switches off automatically if you:

- remove the SmartKey from the ignition lock
- open the driver's door with the SmartKey in position **0**.

If you hear a warning tone when you leave the vehicle, the lights may still be switched on.

- ▶ Turn the light switch to **AUTO**.

Low-beam headlamps

- ▶ **To switch on the low-beam headlamps:** turn the SmartKey in the ignition lock to position **2** or start the engine.
- ▶ Turn the light switch to . The  indicator lamp in the instrument cluster lights up.

Daytime running lights

Daytime running lamps in Canada

The daytime running lamps function is required by law in Canada. It cannot therefore be deactivated.

- ▶ Turn the light switch to **AUTO**.
With the engine running: depending on the ambient light, the daytime running lamps or the low-beam headlamps are switched on. When the low-beam headlamps are switched on, the  indicator lamp in the instrument cluster lights up.

When the engine is running and the vehicle is stationary: if you move the selector lever from a drive position to **P**, the daytime running lamps/low-beam headlamps go out after three minutes.

When the engine is running, the vehicle is stationary and in high ambient light brightness: if you turn the light switch to , the daytime running lamps and the parking lamps are switched on.

If the engine is running and you turn the light switch to , the manual settings take precedence over the daytime running lamps.



Daytime running lamps in the USA

In the USA, the daytime running lamps are deactivated upon delivery from the factory.

- ▶ **To activate the daytime running lamps:** activate the daytime running lamps

function in the on-board computer (▷ page 157).

- ▶ Turn the light switch to **AUTO**.
With the engine running: depending on the ambient light, the daytime running lamps or the low-beam headlamps are switched on. When the low-beam headlamps are switched on, the  indicator lamp in the instrument cluster lights up.

If the engine is running and you turn the light switch to  or , the manual settings take precedence over the daytime running lamps.

Automatic headlamp mode

WARNING

If the light switch is set to **AUTO**, the low-beam headlamps will not come on automatically if it is foggy. This could endanger you and others. Therefore, turn the light switch to  in fog.

The automatic headlamp feature is only an aid. The driver is responsible for the vehicle's lighting at all times.

- ▶ **To switch on automatic headlamp mode:** turn the light switch to **AUTO**.
SmartKey in position **1** in the ignition lock: the parking lamps are switched on or off automatically depending on the brightness of the ambient light.

With the engine running: depending on the brightness of the ambient light, the daytime running lamps⁴ or the low-beam headlamps are switched on or off automatically.

When the low-beam headlamps are switched on, the  indicator lamp in the instrument cluster lights up.

⁴ Only if daytime running lamps have been activated via the on-board computer.

Combination switch

Turn signals

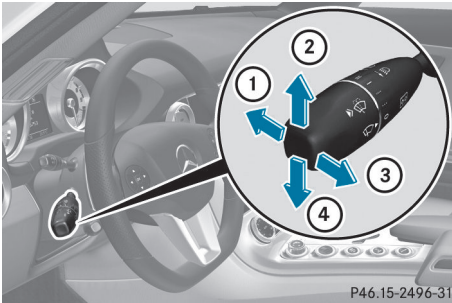



- ① High-beam headlamps
- ② Right turn signal
- ③ High-beam flasher
- ④ Left turn signal

- ▶ **To indicate briefly:** press the combination switch briefly to the pressure point in the direction of arrow ② or ④. The corresponding turn signal flashes three times.
- ▶ **To indicate:** press the combination switch beyond the pressure point in the direction of arrow ② or ④.

High-beam headlamps

- ▶ **To switch on the high-beam headlamps:** turn the SmartKey in the ignition lock to position 2 or start the engine.
- ▶ Turn the light switch to  or **AUTO**.
- ▶ Press the combination switch beyond the pressure point in the direction of arrow ①. In the **AUTO** position, the high-beam headlamps are only switched on when it is dark and the engine is running.

The  indicator lamp in the instrument cluster lights up when the high-beam headlamps are switched on.

- ▶ **To switch off the high-beam headlamps:** move the combination switch back to its normal position. The  indicator lamp in the instrument cluster goes out.

High-beam flasher

- ▶ **To switch on:** turn the SmartKey in the ignition lock to position 1 or 2 or start the engine.
- ▶ Pull the combination switch briefly in the direction of arrow ③.

Hazard warning lamps



The hazard warning lamps automatically switch on if:

- an air bag is deployed.
- the vehicle is slowed down rapidly from a speed of over 45 mph (70 km/h) and comes to a halt.
- ▶ **To switch on the hazard warning lamps:** press button ①. All turn signals flash. If you now switch on a turn signal using the combination switch, only the turn signal lamp on the corresponding side of the vehicle will flash.
- ▶ **To switch off the hazard warning lamps:** press button ①.

The hazard warning lamps are deactivated automatically if the vehicle returns to a speed of over 6 mph (10 km/h) after a full application of the brakes.

- i** The hazard warning lamps still operate if the ignition is switched off.

Headlamp cleaning system

The headlamps are cleaned automatically if the "Wipe with washer fluid" function is operated ten times while the lights are on and the engine is running (▷ page 99). When you switch off the ignition, the automatic headlamp cleaning system is reset and counting is resumed from 0.

Headlamps fogged up on the inside

The headlamps may fog up on the inside if there is high atmospheric humidity.

- ▶ Drive with the headlamps switched on. The level of moisture diminishes, depending on the length of the journey and the weather conditions (humidity and temperature).

If the level of moisture does not diminish:



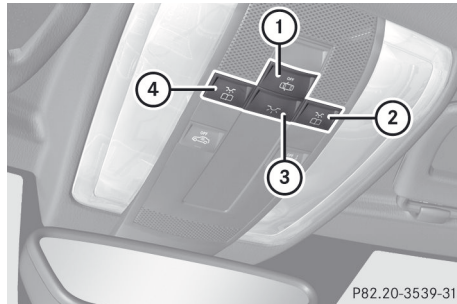

- ▶ Have the headlamps checked at a qualified specialist workshop.

Interior lighting

Overview of interior lighting



Overhead control panel

- ①  Switches the automatic interior lighting control on/off
- ②  Switches the right-hand reading lamp on/off
- ③  Switches the interior lighting on/off
- ④  Switches the left-hand reading lamp on/off

Interior lighting control

Important notes

In order to prevent the vehicle's battery from discharging, the interior lighting functions are automatically deactivated after some time except for when the SmartKey is in position 2 in the ignition lock.

Automatic interior lighting control

- ▶ **To switch on/off:** press the  button. When the automatic interior lighting control is activated, the button is flush with the overhead control panel.



The interior lighting automatically switches on if you:

- unlock the vehicle
- open a door
- remove the SmartKey from the ignition lock

The interior light is activated for a short while when the SmartKey is removed from the

ignition lock. You can activate this delayed switch-off using the on-board computer (▷ page 159).

Manual interior lighting control

- ▶ **To switch the interior lighting on/off:** press the  button.
- ▶ **To switch the reading lamps on/off:** press the  button.

Crash-responsive emergency lighting

The interior lighting is activated automatically if the vehicle is involved in an accident.

- ▶ **To switch off the crash-responsive emergency lighting:** press the hazard warning lamp button.
- or
- ▶ Lock and then unlock the vehicle using the key.

Replacing bulbs

Important safety notes

Xenon bulbs

If your vehicle is equipped with Xenon bulbs, you can recognize this by the following: the cone of light from the Xenon bulbs moves from the top to the bottom and back again when you start the engine. For this to be observed, the lights must be switched on before starting the engine.

DANGER

Xenon bulbs carry a high voltage. You could get an electric shock and be seriously or even fatally injured if you touch the electric contacts on Xenon bulbs. Therefore, never remove the cover from Xenon bulbs.

Do not change Xenon bulbs yourself, but have them replaced at a qualified specialist workshop which has the necessary specialist

knowledge and tools to carry out the work required.

Mercedes-Benz recommends that you use an authorized Mercedes-Benz Center for this purpose. In particular, work relevant to safety or on safety-related systems must be carried out at a qualified specialist workshop.

Bulbs and lamps are an important aspect of vehicle safety. You must therefore make sure that these function correctly at all times. Have the headlamp setting checked regularly.

Other bulbs

There are bulbs other than the Xenon bulbs that you cannot replace. Replace only the bulbs listed (▷ page 99). Have the bulbs that you cannot replace yourself changed at a qualified specialist workshop.

Mercedes-Benz recommends that you use an authorized Mercedes-Benz Center for this purpose. In particular, work relevant to safety or on safety-related systems must be carried out at a qualified specialist workshop.

If you require assistance changing bulbs, consult a qualified specialist workshop.

Do not touch the glass tube of new bulbs with your bare hands. Even minor contamination can burn into the glass surface and reduce the service life of the bulbs. Always use a lint-free cloth or only touch the base of the bulb when installing.

Only use bulbs of the correct type.

If the new bulb still does not light up, consult a qualified specialist workshop.

Bulbs and lamps are an important aspect of vehicle safety. You must therefore make sure that these function correctly at all times. Have the headlamp setting checked regularly.

WARNING

Bulbs and lamps can be very hot. You should therefore allow them to cool down before you change them. Otherwise, you could be burned if you touch them.

Keep bulbs out of the reach of children. Otherwise, they could damage the bulbs, for example, and injure themselves.

Never use a bulb which has been dropped. Such a bulb may break or even explode and injure you.

Halogen bulbs are pressurized and can explode when you change them, particularly if they are very hot. You should therefore wear eye protection and gloves when you are changing them.

Changing the front bulbs

You cannot replace the bulbs at the front yourself. Contact a qualified specialist workshop which has the necessary specialist knowledge and tools to carry out the work required. Mercedes-Benz recommends that you use an authorized Mercedes-Benz Center for this purpose.

Changing the rear bulbs

License plate lamps

The only rear bulbs you can change are the W 5 W license plate lamp bulbs.

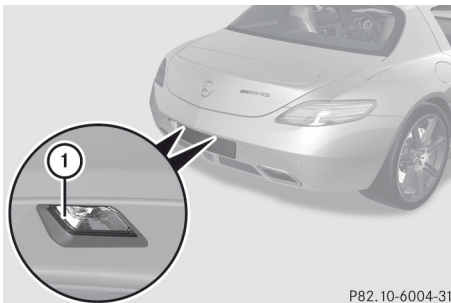

P82.10-6004-31

- ▶ Switch off the lights.
- ▶ Lever lamp housing ① out of the frame using a screwdriver.
- ▶ Unscrew the bulb holder from the lamp housing and pull out the bulb.

- ▶ Insert a new bulb into the bulb holder and screw the bulb holder into the lamp housing.
- ▶ Press the lamp housing back into the frame until it engages.

Windshield wipers

Switching the windshield wipers on/off

⚠ WARNING

The windshield will not longer be wiped properly if the wiper blades are worn. This could prevent you from observing the traffic conditions, thereby causing an accident. Replace the wiper blades twice a year, ideally in spring and fall.

- ❗ Do not operate the windshield wipers when the windshield is dry, as this could damage the wiper blades. Moreover, dust that has collected on the windshield can scratch the glass if wiping takes place when the windshield is dry.
- ❗ If the windshield wipers leave smears on the windshield after the vehicle has been washed in an automatic car wash, wax or other residues may be the reason for this. Clean the windshield using washer fluid after washing the vehicle in an automatic car wash.

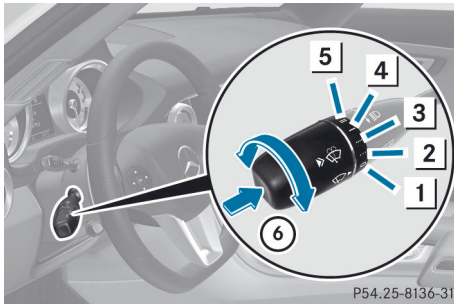

Combination switch

- 1 0 Windshield wipers off
- 2 ... Intermittent wipe, low⁵
- 3 Intermittent wipe, high⁶
- 4 — Continuous wipe, slow
- 5 = Continuous wipe, fast
- 6 Single wipe / To wipe the windshield using washer fluid

- ▶ Switch on the ignition.
- ▶ Turn the combination switch to the corresponding position.

! Intermittent wiping with rain sensor: due to optical influences and the windshield becoming dirty in dry weather conditions, the windshield wipers may be activated inadvertently. This could then damage the windshield wiper blades or scratch the windshield.

For this reason, you should always switch off the windshield wipers in dry weather.

In the ... or position, the appropriate wiping frequency is set automatically according to the intensity of the rain. In the position, the rain sensor is more sensitive than in the ... position, causing the windshield wipers to wipe more frequently.

⁵ Rain sensor set to low sensitivity.

⁶ Rain sensor set to high sensitivity.

Replacing the wiper blades

Important safety notes

! WARNING

The wiper arms could start moving and cause an injury if you leave the windshield wipers switched on.

Remove the key from the ignition lock before replacing the wiper blades.

! To avoid damaging the wiper blades, make sure that you touch only the wiper arm of the wiper.

! Never open the hood if a windshield wiper arm has been folded away from the windshield.

Never fold a windshield wiper arm without a wiper blade back onto the windshield.

Hold the windshield wiper arm firmly when you change the wiper blade. If you release the windshield wiper arm without a wiper blade and it falls onto the windshield, the windshield may be damaged by the force of the impact.

Mercedes-Benz recommends that you have the wiper blades replaced by a qualified specialist workshop, e.g. at an authorized Mercedes-Benz Center.

Replacing the wiper blades

Removing the wiper blades

Moving the wiper blades to a vertical position

- ▶ Switch off the engine.
- ▶ Remove your foot from the brake pedal.
- ▶ Set the windshield wipers to position —.
- ▶ Press the Start/Stop button repeatedly until the windshield wipers start.

- ▶ When the wiper arms have reached a vertical position, press the Start/Stop button.
- ▶ Fold the wiper arm away from the windshield until it engages.
- ▶ Set the wiper blade at right angles to the wiper arm.

Removing the wiper blades

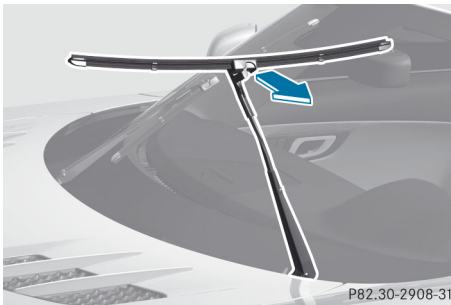

- ▶ Remove the wiper blade from the retainer on the wiper arm in the direction of the arrow.

Installing the wiper blades

- ▶ Slide the new wiper blade into the retainer on the wiper arm in the opposite direction to the arrow.
- ▶ Turn the wiper blade parallel to the wiper arm.
- ▶ Fold the wiper arm back onto the windshield.

Problems with the windshield wipers

The windshield wipers are obstructed

Leaves or snow, for example, may be obstructing the windshield wiper movement. The wiper motor has been deactivated.

- ▶ Switch off the engine using the Start/Stop button and open the driver's door.
- ▶ Remove the cause of the obstruction.
- ▶ Switch the windshield wipers back on.

The windshield wipers are inoperative

The windshield wiper drive is malfunctioning.

- ▶ Select another wiper speed on the combination switch.
- ▶ Have the windshield wipers checked at a qualified specialist workshop.

The spray nozzles are misaligned

The windshield washer fluid from the spray nozzles no longer hits the center of the windshield. The spray nozzles are misaligned.

- ▶ Have the spray nozzles adjusted at a qualified specialist workshop.

The wiper arms are on the windshield

The wiper arms have been moved by an external force.

- ▶ Select key position **2** (ignition) with the Start/Stop button. The wiper arms move back down automatically.

Useful information	104
Overview of climate control systems	104
Operating the climate control system	106
Setting the air vents	110

Useful information

- i** This Operator's Manual describes all models and all standard and optional equipment of your vehicle available at the time of publication of the Operator's Manual. Country-specific differences are possible. Please note that your vehicle may not be equipped with all features described. This also applies to safety-related systems and functions.
- i** Please read the information on qualified specialist workshops (> page 21).

system only works optimally when the side windows and the roof are closed.

- i** Coupe: ventilate the vehicle for a brief period during warm weather, e.g. using the convenience opening feature (> page 77). This will speed up the cooling process and the desired vehicle interior temperature will be reached more quickly.
Roadster: ventilate the vehicle for a brief period during warm weather. This will speed up the cooling process and the desired vehicle interior temperature will be reached more quickly.

- i** The integrated filter can filter out most particles of dust, and completely filters out pollen. A clogged filter reduces the amount of air supplied to the vehicle interior. For this reason, you should always observe the interval for replacing the filter, which is specified in the Maintenance Booklet. As it depends on environmental conditions, e.g. heavy air pollution, the interval may be shorter than stated in the Maintenance Booklet.

Overview of climate control systems

Important safety notes

⚠ WARNING

Severe conditions (e.g. strong air pollution) may require replacement of the filter before its scheduled replacement interval. A clogged filter will reduce the air volume to the interior and the windows could fog up, impairing visibility and endangering you and others. Have a blocked filter replaced at a Mercedes-Benz Center as soon as possible.

⚠ WARNING

Follow the recommended settings for heating and cooling given on the following pages. Otherwise, the windows could fog up, impairing visibility and endangering you and others.

The automatic climate control regulates the temperature and the humidity in the vehicle interior and filters undesirable substances out of the air.

Coupe: the automatic climate control is only operational if the engine is running. Optimum operation is achieved only when you drive with the side windows closed.

Roadster: the automatic climate control is only operational if the engine is running. The

Control panel for 2-zone automatic climate control

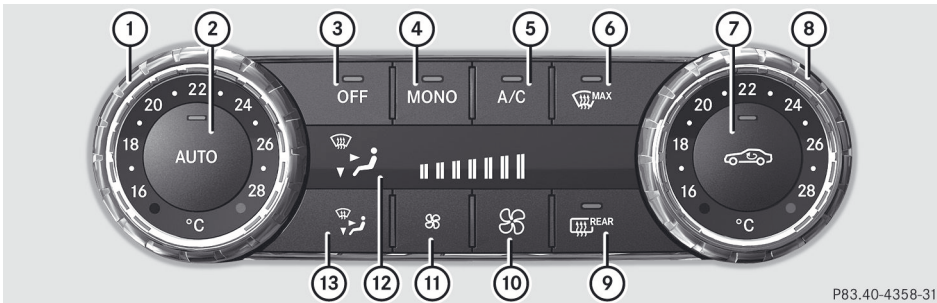

P83.40-4358-31

Canada only

- ① Sets the temperature, left (▷ page 107)
- ② Sets climate control to automatic (▷ page 107)
- ③ Switches climate control on/off (▷ page 106)
- ④ Switches the MONO function on/off
- ⑤ Activates/deactivates cooling with air dehumidification (▷ page 106)
- ⑥ Defrosts the windshield (▷ page 108)
- ⑦ Activates/deactivates air-recirculation mode (▷ page 109)
- ⑧ Sets the temperature, right (▷ page 107)
- ⑨ Switches the rear window defroster on/off (▷ page 109)
- ⑩ Increases the airflow (▷ page 108)
- ⑪ Reduces the airflow (▷ page 108)
- ⑫ Display
- ⑬ Sets the air distribution (▷ page 107)

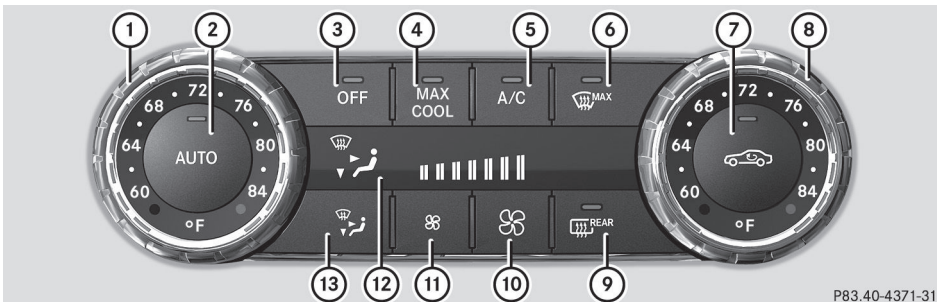

P83.40-4371-31

USA only

- ① Sets the temperature, left
- ② Sets climate control to automatic (▷ page 107)
- ③ Switches climate control on/off (▷ page 106)
- ④ Switches maximum cooling MAX COOL on/off (▷ page 108)
- ⑤ Activates/deactivates cooling with air dehumidification (▷ page 106)

- ⑥ Defrosts the windshield (▷ page 108)
- ⑦ Activates/deactivates air-recirculation mode (▷ page 109)
- ⑧ Sets the temperature, right (▷ page 107)
- ⑨ Switches the rear window defroster on/off (▷ page 109)
- ⑩ Increases the airflow (▷ page 108)
- ⑪ Reduces the airflow (▷ page 108)
- ⑫ Display
- ⑬ Sets the air distribution (▷ page 107)

Notes on using 2-zone automatic climate control

The following contains instructions and recommendations to enable you to get the most out of your automatic climate control.

- Activate climate control using the **AUTO** and **A/C** buttons. The indicator lamps in the **AUTO** and **A/C** buttons light up.
- Set the temperature to 72 °F (22 °C).
- Only use the "defrosting" function briefly until the windshield is clear again.
- Only use "air-recirculation" mode briefly, e.g. if there are unpleasant outside odors or when in a tunnel. The windows could otherwise fog up as in air-recirculation mode no fresh air is drawn into the vehicle.
- Use the MONO function if you want to adopt the temperature and air distribution settings from the driver's side for all climate zones. The indicator lamp in the **MONO** button lights up.

Operating the climate control system

Activating/deactivating climate control

WARNING

When the climate control system is deactivated, the outside air supply and circulation are also deactivated. Only choose this setting for a short time. Otherwise the windows could fog up, impairing visibility and endangering you and others.

 Switch on climate control primarily using the **AUTO** button (▷ page 107).

- ▶ Select key position **2** with the Start/Stop button.
 - ▶ **To switch on:** press the **AUTO** button. The indicator lamp in the **AUTO** button lights up. Airflow and air distribution are set to automatic mode.
- or
- ▶ Press the **OFF** button. The indicator lamp in the **OFF** button goes out. The previously selected settings come into effect again.
 - ▶ **To switch off:** press the **OFF** button. The indicator lamp in the **OFF** button lights up.

Activating/deactivating the cooling with air dehumidification function

Important information





The cooling with air dehumidification function is only available when the engine is running. The air inside the vehicle is cooled and dehumidified according to the temperature selected.

WARNING

If you switch off the cooling function, the vehicle will not be cooled when weather conditions are warm. The windows can fog up more quickly. Window fogging may impair visibility and endanger you and others.

Condensation may drip from the underside of the vehicle when it is in cooling mode.

Activating/deactivating

- ▶ **To activate:** press the  button. The indicator lamp in the  button lights up.
- ▶ **To switch off:** press the  button. The indicator lamp in the  button goes out. The cooling with air dehumidification function has a delayed switch-off feature.

Problems with the cooling with air dehumidification function

When you press the  button, the indicator lamp in the button flashes three times or remains off. You can no longer switch on the cooling with air dehumidification function.

- ▶ Consult a qualified specialist workshop.





Setting climate control to automatic

WARNING

If you switch off the cooling function, the vehicle will not be cooled when weather conditions are warm. The windows can fog up more quickly. Window fogging may impair visibility and endanger you and others.



In automatic mode, the set temperature is controlled automatically. The system automatically regulates the temperature of the dispensed air, the airflow and the air distribution.

Automatic mode will achieve optimal operation if cooling with air dehumidification is also activated. If desired, cooling with air dehumidification can be deactivated.







- ▶ Select key position **2** with the Start/Stop button.
- ▶ Set the desired temperature.
- ▶ **To activate:** press the  button. The indicator lamp in the  button lights up. Automatic air distribution and airflow are activated.
- ▶ **To switch off:** press the  button. The indicator lamp in the  button goes out. Automatic air distribution and airflow are deactivated.

Setting the temperature

Different temperatures can be set for the driver's and front-passenger sides.



- ▶ Select key position **2** with the Start/Stop button.
- ▶ **To increase/reduce:** turn controls  and  clockwise or counter-clockwise (▷ page 105).
Only change the temperature setting in small increments. Start at 72 °F (22 °C).

Setting the air distribution

-  Directs the airflow through the defroster vents
-  Directs the airflow through the center and side air vents
-  Directs the airflow through the footwell air vents
-  Directs the airflow through the center and side air vents as well as the footwell air vents
-  Directs the airflow to the entire vehicle interior
-  Directs the airflow through the center and side air vents, as well as the defroster vents
-  Directs the airflow through the footwell and defroster vents

- ▶ Select key position **2** with the Start/Stop button.
- ▶ Press the  button repeatedly until the desired symbol appears in the display. The indicator lamp in the **AUTO** button goes out. Automatic control is deactivated and the air distribution is controlled according to the selected setting.

Setting the airflow

- ▶ Select key position **2** with the Start/Stop button.
- ▶ **To increase/reduce:** press the  or  button.



Switching the mono function on/off

The MONO function is only available in vehicles for Canada.



You can use the MONO function to adopt the temperature and air distribution settings on the driver's side for the front-passenger side.

- ▶ Press the **MONO** button.
The indicator lamp in the **MONO** button lights up or goes out.

Defrosting the windshield

- i** You should only select the defrosting function until the windshield is clear again.
- ▶ Select key position **2** with the Start/Stop button.
- ▶ **To activate:** press the  button. The indicator lamp in the  button lights up. The system automatically switches to the following functions:
 - cooling with air dehumidification on
 - high airflow⁷
 - high temperature⁷

- air distribution to the windshield and front side windows
- air-recirculation mode off

- ▶ **To switch off:** press the  button. The indicator lamp in the  button goes out. The previously selected settings come into effect again. The cooling with air dehumidification function remains on. Air-recirculation mode remains deactivated.

or

- ▶ Press the **AUTO** button. The indicator lamp in the  button goes out. Airflow and air distribution are set to automatic mode.

or

- ▶ Turn controls ① or ⑧ clockwise or counter-clockwise (▷ page 105).

or



- ▶ Press the  or  button.

Switching maximum cooling MAX COOL on/off

The MAX COOL function is only available in vehicles for the USA.

MAX COOL is only operational when the engine is running.

When you activate MAX COOL, climate control switches to the following functions:

- maximum cooling
- maximum airflow
- air-recirculation mode on
- ▶ **To activate:** press the  button. The indicator lamp in the button lights up.
- ▶ **To deactivate:** press the  button again. The indicator lamp in the button goes out. The previously selected settings come into effect again.
- i** To deactivate MAX COOL press the **OFF**, **AUTO**, or  button.



⁷ Depending on the outside temperature.

Defrosting the windows

Windows fogged up on the inside

- ▶ Activate the cooling with air dehumidification function.
- ▶ Activate automatic mode.
- ▶ If the windows continue to fog up, activate the defrosting function.

Windows fogged up on the outside

- ▶ Activate the windshield wipers.
- ▶ Press the  button repeatedly until the  or  symbol appears in the display.

- i** You should only select this setting until the windshield is clear again.

Rear window defroster



Activating/deactivating

WARNING

Any accumulation of snow and ice should be removed from the rear window before driving. Visibility could otherwise be impaired, endangering you and others.

The rear window defroster has a high current draw. You should therefore switch it off as soon as the window is clear. It otherwise switches off automatically after several minutes.

If the battery voltage is too low, the rear window defroster may switch off.

- ▶ Select SmartKey position **2** with the Start/Stop button.
- ▶ Press the  button. The indicator lamp in the  button lights up or goes out.

Problems with the rear window defroster

The rear window defroster has deactivated prematurely or cannot be activated. The on-board voltage is too low because too many electrical consumers are switched on.

- ▶ Switch off any consumers that are not required, e.g. seat heating or interior lighting.



When the battery is sufficiently charged, the rear window defroster is activated again automatically.

Activating/deactivating air-recirculation mode



You can deactivate the flow of fresh air if unpleasant odors are entering the vehicle from outside. The air already inside the vehicle will then be recirculated.

WARNING

Fogged windows impair visibility, endangering you and others. If the windows begin to fog on the inside, switching off the air recirculation mode immediately should clear interior window fogging. If interior window fogging persists, make sure the air conditioning is activated, or press the  button.

- ▶ Select SmartKey position **2** with the Start/Stop button.
- ▶ **To activate:** press the  button. The indicator lamp in the  button lights up.

- i** Air-recirculation mode is activated automatically at high outside temperatures. When air-recirculation mode is activated automatically, the indicator lamp in the  button is not lit. Outside air is added after about 30 minutes.

- ▶ **To switch off:** press the  button. The indicator lamp in the  button goes out.

- ▶ **i** Air-recirculation mode deactivates automatically:
 - after approximately five minutes if outside temperatures are less than about 41 °F (5 °C)
 - after approximately five minutes if cooling with air dehumidification is deactivated
 - after approximately 30 minutes if outside temperatures are over about 41 °F (5 °C)

Setting the air vents

Important safety notes

WARNING

When operating the climate control, the air that enters the passenger compartment through the air vents can be very hot or very cold (depending on the set temperature). This could cause burns or frostbite to unprotected skin in the immediate area of the air vents.

Always keep sufficient distance between unprotected parts of the body and the air vents. If necessary, use the air distribution adjustment to direct the air to air vents in the vehicle interior that are not in the immediate area of unprotected skin.

In order to ensure the direct flow of fresh air through the air vents into the vehicle interior, please observe the following notes:

- keep the air inlet on the right-hand side of the hood free of blockages, such as ice, snow or leaves.
- never cover the air vents or air intake grilles in the vehicle interior.
- ▶ **i** For virtually draft-free ventilation, adjust the sliders of the air vents to the center position.

Setting the center air vents

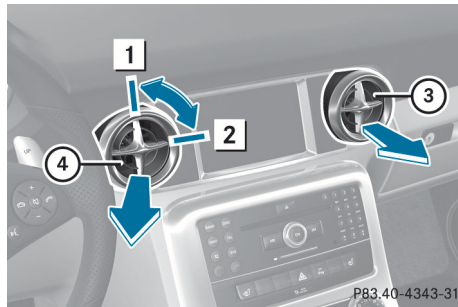

- ▶ **1** To open the center air vent
- ▶ **2** To close the center air vent
- ▶ **3** Center air vent, right
- ▶ **4** Center air vent, left

- ▶ **To open the center air vent:** turn the adjuster in center air vent **3** or **4** in the direction of the arrow to position **1**.

- ▶ **To close the center air vent:** turn the adjuster in center air vent **3** or **4** in the direction of the arrow to position **2**.

Setting the side air vents

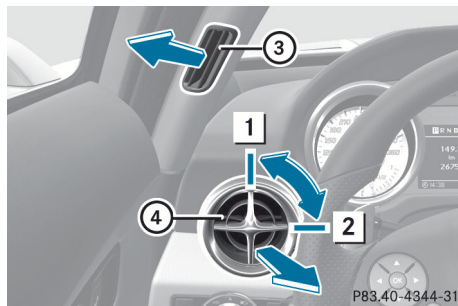

- ▶ **1** To open the side air vent
- ▶ **2** To close the side air vent
- ▶ **3** Side window defroster vent
- ▶ **4** Side air vent

- ▶ **To open the side air vent:** turn the adjuster in side air vent ④ in the direction of the arrow to position 1.
- ▶ **To close the side air vent:** turn the adjuster in side air vent ④ in the direction of the arrow to position 2.

Setting the AIRSCARF vents (Roadster)

WARNING

When operating the climate control, the air that enters the passenger compartment through the air vents can be very hot or very cold (depending on the set temperature). This could cause burns or frostbite to unprotected skin in the immediate area of the air vents.

Always keep sufficient distance between unprotected parts of the body and the air vents. If necessary, use the air distribution adjustment to direct the air to air vents in the vehicle interior that are not in the immediate area of unprotected skin.

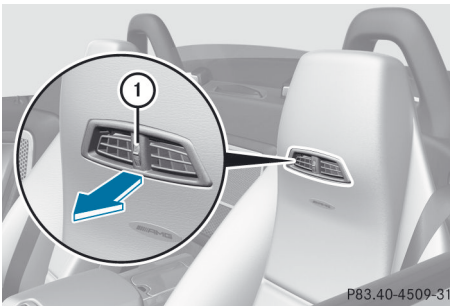

You can adjust the blower output of AIRSCARF vents ① using the AIRSCARF button (▷ page 87).

Useful information	114
Breaking-in notes	114
Driving	114
AMG SPEEDSHIFT DCT 7-speed sports transmission	119
AMG button (SETUP)	126
Refueling	127
Parking	129
Driving tips	132
Driving systems	136

Useful information

- i** This Operator's Manual describes all models and all standard and optional equipment of your vehicle available at the time of publication of the Operator's Manual. Country-specific differences are possible. Please note that your vehicle may not be equipped with all features described. This also applies to safety-related systems and functions.
- i** Please read the information on qualified specialist workshops (▷ page 21).

Breaking-in notes

The first 1000 miles (1500 km)

The more you look after the engine when it is new, the more satisfied you will be with its performance in the future.

- Drive at varying vehicle speeds and engine speeds for the first 1000 miles (1500 km) for this reason.
- Do not drive faster than 85 mph (140 km/h) for the first 1000 miles (1500 km).
- Only allow the engine to reach a maximum engine speed of 4,500 rpm briefly.
- Avoid overstraining the vehicle during this period, e.g. driving at full throttle. Do not exceed $\frac{2}{3}$ of the maximum permitted engine speed for each gear.
- Select the manual drive program **M** in good time.
- Do not carry out a RACE START.
- Do not manually shift to a lower gear to brake the vehicle.
- If possible, do not depress the accelerator pedal past the point of resistance (kickdown).
- Only select the shift range limits **3**, **2** or **1** when driving slowly, e.g. in mountainous terrain.

After 1000 miles (1500 km), you can increase the engine speed gradually and bring the vehicle up to full speed.

- i** You should also observe these breaking-in notes if your vehicle's engine or transmission has been replaced.
- i** Always observe the respective speed restrictions.

Driving

Important safety notes

WARNING

Do not keep any objects in the driver's footwell. If you use a floor mat or carpet in the driver's footwell, make sure that they are correctly secured and that there is sufficient clearance for the pedals.

Do not place several floor mats on top of one another.

The objects or floor mats could otherwise get between the pedals in the event of sudden braking or acceleration. You may then no longer be able to brake, change gear or accelerate as intended. This may result in an accident and injury.

WARNING

Do not change down for additional engine braking on a slippery road surface. This could cause the drive wheels to lose their grip and the vehicle could skid. This could cause you to lose control of your vehicle and cause an accident.

WARNING

It is dangerous to shift the automatic transmission out of parking position **P** or neutral position **N** if the engine speed is higher than idle speed. If your foot is not firmly on the brake pedal, the vehicle could accelerate quickly forward or in reverse. You could lose control of the vehicle and hit someone or something. Only shift into gear

when the engine is idling normally and when your right foot is firmly on the brake pedal.

! Warm up the engine quickly. Do not use the engine's full performance until it has reached operating temperature. The operating temperature has been reached when the engine oil temperature display in the on-board computer's AMG menu no longer flashes.

Only shift into reverse gear when the vehicle is stationary.

Where possible, avoid spinning the drive wheels when pulling away on slippery roads. You could otherwise damage the drive train.

! During a cold start, if the engine oil temperature is low (below 0 °C), maximum engine speed will be limited to protect the engine. To protect the engine and maintain smooth engine operation, avoid driving at full throttle when the engine is cold.

! During a cold start, if the engine oil temperature is low (below 32 °F) (0 °C), maximum engine speed will be limited to protect the engine. To protect the engine and maintain smooth engine operation, avoid driving at full throttle when the engine is cold.

SmartKey positions

KEYLESS-GO start function

You can switch the engine on and off with the Start/Stop button. For this, the SmartKey must be inside the vehicle. The Start/Stop button is located in the center console and is illuminated when the vehicle is unlocked.

Pressing the Start/Stop button several times in succession corresponds to the different key positions in the ignition lock. This is only the case if you are not depressing the brake pedal.

If you depress the brake pedal and press the Start/Stop button, the engine starts immediately.

If there is a SmartKey in the ignition lock, this takes precedence over the KEYLESS-GO start function.

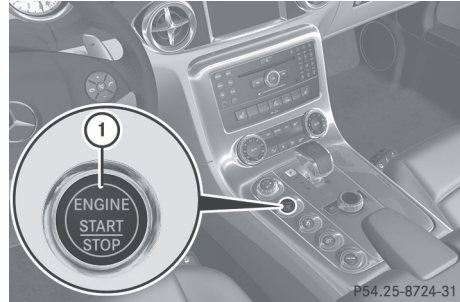

► **Position 0:** if Start/Stop button ① has not yet been pressed, this corresponds to the SmartKey being removed from the ignition.

► **Position 1:** press Start/Stop button ①. You can now activate the windshield wipers, for example.

If you press Start/Stop button ① twice when in this position and the driver's door is open, the power supply is deactivated again.

► **Position 2 (ignition):** press Start/Stop button ① twice.

If you press Start/Stop button ① once when in this position and the driver's door is open, the power supply is deactivated again.

SmartKey

You can also start the vehicle with the SmartKey in the ignition lock.

The ignition lock is located in the rear stowage space of the center console.

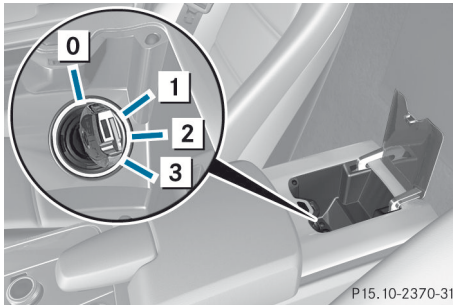

P15.10-2370-31

- 0 To remove the SmartKey
 - 1 Power supply for some consumers, such as the windshield wipers
 - 2 Ignition (power supply for all consumers) and drive position
 - 3 To start the engine
- i** The SmartKey can be turned in the ignition lock even if it is not the correct SmartKey for the vehicle. The ignition is not switched on. The engine cannot be started.

Starting the engine

Important safety notes

⚠ WARNING

Never leave the engine running in enclosed spaces. The exhaust gases contain toxic carbon monoxide. Breathing in exhaust fumes is a health hazard and can lead to unconsciousness or death.

⚠ WARNING

Inhalation of exhaust gas is hazardous to your health. All exhaust gas contains carbon monoxide (CO), and inhaling it can cause unconsciousness and possible death. Do not run the engine in confined areas (such as a garage) which are not properly ventilated. If you think that exhaust gas fumes are entering the vehicle while driving, have the cause determined and corrected immediately. If you must drive under these

conditions, drive only with at least one window fully open at all times.

- i** Do not depress the accelerator pedal when starting the engine.

Starting procedure with the Start/Stop button

⚠ WARNING

As long as the SmartKey is in your vehicle, the vehicle can be started. Therefore, never leave children unattended in the vehicle, as they could otherwise accidentally start the engine. When leaving the vehicle, always take the SmartKey with you and lock the vehicle. Do not leave children unattended in the vehicle, or with access to an unlocked vehicle. A child's unsupervised access to a vehicle could result in an accident and/or serious personal injury.

- i** The Start/Stop button can be used to start the vehicle without inserting the SmartKey into the ignition lock. You merely need to carry the SmartKey on your person.
 - ▶ Depress the brake pedal and keep it depressed.
 - ▶ Press the Start/Stop button once (▷ page 115). The engine starts.

Starting procedure with the SmartKey

If the Start/Stop button is inoperative, you can also start the vehicle using the SmartKey in the ignition lock.

- ▶ Turn the SmartKey to position **3** in the ignition lock (▷ page 115) and release it as soon as the engine is running.

Pulling away

AMG SPEEDSHIFT DCT 7-speed sports transmission

WARNING

It is dangerous to shift the transmission out of park position **P** or neutral position **N** if the engine is running at anything more than idling speed. If you do not depress the brake pedal with force, the vehicle may accelerate forwards or backwards. This could cause you to lose control of your vehicle and cause a collision. Only shift the transmission into the drive position when you are firmly depressing the brake pedal.

i It is only possible to shift the transmission from position **P** to the desired position if the engine is running and you depress the brake pedal.

Only then is the parking lock released. If the brake pedal is not depressed, the E-SELECT lever can still be moved but the parking lock remains engaged.

- ▶ Depress the brake pedal and keep it depressed.
- ▶ Use the E-SELECT lever to shift the transmission to position **D** or **R**.
- ▶ Release the brake pedal.
- ▶ Carefully depress the accelerator pedal. The electric parking brake is automatically released (> page 130).
- i** The vehicle locks centrally once you have pulled away. The locking knobs in the doors drop down.
- i** The vehicle locks centrally once you have pulled away. The locking knobs in the doors drop down. The automatic door lock can also be deactivated (Roadster only).

Hill start assist

Hill start assist helps you when pulling away on uphill gradients. It holds the vehicle for a short time after you have removed your foot from the brake pedal. This gives you enough

time to move your foot from the brake pedal to the accelerator pedal and depress it before the vehicle begins to roll.

WARNING

Never leave the vehicle when it is being held by hill start assist. After approximately one second, hill start assist will no longer brake your vehicle and it could roll away.

- ▶ Take your foot off the brake pedal.
- i** Once you have taken your foot off the brake pedal, the vehicle is held for around one second.
- ▶ Pull away.

Hill start assist does not function if:

- you are pulling away on a level road or a downhill gradient.
- the transmission is in position **N**.
- the vehicle is secured with the electric parking brake.
- ESP[®] is malfunctioning.

Problems with the engine

Problem	Possible causes/consequences and ► Solutions
The engine does not start. The starter motor can be heard.	<ul style="list-style-type: none"> • There is a malfunction in the engine electronics. • There is a malfunction in the fuel supply. <p>► Before attempting to start the engine again, turn the SmartKey in the ignition back to position 0 or press the Start/Stop button repeatedly until all indicator lamps in the instrument cluster go out.</p> <p>► Try to start the engine again (▷ page 116). Avoid excessively long and frequent attempts to start the engine as these will drain the battery.</p> <p>If the engine does not start after several attempts:</p> <p>► Consult a qualified specialist workshop, e.g. an authorized Mercedes-Benz Center.</p>
The engine does not start. You cannot hear the starter motor.	<p>The on-board voltage is too low because the battery is too weak or discharged.</p> <p>► Jump-start the vehicle (▷ page 243).</p> <p>If the engine does not start despite attempts to jump-start it:</p> <p>► Consult a qualified specialist workshop, e.g. an authorized Mercedes-Benz Center.</p> <p>The starter motor was exposed to a thermal load that was too high.</p> <p>► Allow the starter motor to cool down for approximately two minutes.</p> <p>► Try to start the engine again.</p> <p>If the engine still does not start:</p> <p>► Consult a qualified specialist workshop, e.g. an authorized Mercedes-Benz Center.</p>
The engine is not running smoothly and is misfiring.	<p>There is a malfunction in the engine electronics or a mechanical component of the engine management system.</p> <p>► Only depress the accelerator pedal slightly.</p> <p>► Have the cause rectified immediately at a qualified specialist workshop, e.g. an authorized Mercedes-Benz Center. Otherwise, non-combusted fuel may get into the catalytic converter and damage it.</p>

Problem	Possible causes/consequences and ► Solutions
The coolant temperature gauge shows a value above 248 °F(120 °C).	The coolant level is too low. The coolant is too hot and the engine is no longer being cooled sufficiently. <ul style="list-style-type: none"> ► Stop as soon as possible and allow the engine and the coolant to cool down. ► Check the coolant level (▷ page 220). Observe the warning notes as you do so and add coolant if necessary.
	If the coolant level is correct, the engine radiator fan may be faulty. The coolant is too hot and the engine is no longer being cooled sufficiently. <ul style="list-style-type: none"> ► At coolant temperatures under 248 °F(120 °C), drive on to the nearest qualified specialist workshop, e.g. to an authorized Mercedes-Benz Center. ► Avoid heavy loads on the engine as you do so, e.g. driving in mountainous terrain and stop-and-go traffic.

AMG SPEEDSHIFT DCT 7-speed sports transmission

Important safety notes

⚠ WARNING

It is dangerous to shift the transmission out of park position **P** or neutral position **N** if the engine is running at anything more than idling speed. If you do not depress the brake pedal with force, the vehicle may accelerate forwards or backwards. This could cause you to lose control of your vehicle and cause a collision. Only shift the transmission into the drive position when you are firmly depressing the brake pedal.

E-SELECT selector lever

Overview of transmission positions

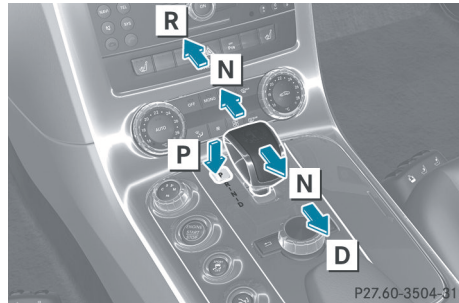

- P** Park position with parking lock
- R** Reverse gear
- N** Neutral
- D** Drive

! If the engine speed is too high or if the vehicle is rolling, do not shift the transmission directly from **D** to **R**, from **R** to **D** or directly to **P**.

Do not open the driver's door while the vehicle is in motion. At low speeds in transmission position **D** or **R**, park position **P** is otherwise engaged automatically.

The transmission could be damaged.

- ▶ **i** The E-SELECT lever always returns to its original position.

The current transmission position **P**, **R**, **N** or **D** appears in the transmission position display in the multifunction display.

If you wish to select a transmission position or to disengage park position **P**, the engine must be running.

Engaging park position **P**

- ▶ When the vehicle is stationary, depress the brake pedal.
- ▶ Press the **P** button in the center console.

- ▶ **i** If you depress the brake pedal and push the E-SELECT lever forwards or back to the first point of resistance, park position **P** is disengaged. The transmission shifts to neutral **N**.

To shift directly from **P** to **R**:

- ▶ Depress the brake pedal and push the E-SELECT lever forwards past the first point of resistance.

To shift directly from **P** to **D**:

- ▶ Depress the brake pedal and push the E-SELECT lever back past the first point of resistance.

Engaging park position **P** automatically

Park position is engaged automatically in the following circumstances:

- if you switch off the engine using the Start/ Stop button and open the driver's or front-passenger door.
- if you remove the SmartKey from the ignition lock.
- if you open the door while traveling at low speed in transmission position **D** or **R**.

Shifting to neutral **N**

- ▶ When the vehicle is stationary, depress the brake pedal.
- ▶ Push the E-SELECT lever forwards or back to the first point of resistance.

- ▶ **i** If you use the E-SELECT lever to shift the transmission to **N** before switching off the engine, the transmission remains in **N** for approximately 30 minutes. If you open the driver's or front-passenger door during this period, the transmission automatically shifts to **P**.

If the SmartKey is in the ignition lock and you use the E-SELECT lever to shift the transmission to **N** before switching off the engine, the transmission remains in **N**. This still applies if you open the driver's or front-passenger door. Further information is available in the "Car wash" section (▶ page 223).

Engaging reverse gear **R**

- ▶ When the vehicle is stationary, depress the brake pedal.
- ▶ Push the E-SELECT lever forward past the first point of resistance.

Shifting to transmission position **D**

- ▶ When the vehicle is stationary, depress the brake pedal.
- ▶ Push the E-SELECT lever back past the first point of resistance.

Transmission position and drive program display

Display in transmission positions P, R and N

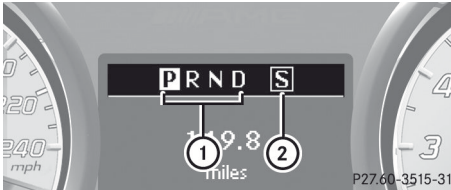

- ① Transmission position: currently selected transmission position is displayed in inverted colors
- ② Drive program (C/S/S+/M)

In addition to drive program ② being shown in the multifunction display, the currently selected drive program is indicated in red on the drive program selector switch.

Display when in transmission position D

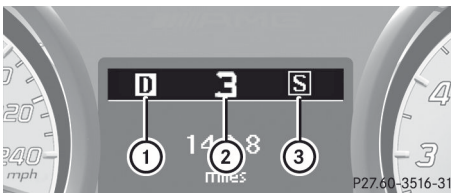

- ① Transmission position
- ② Gear
- ③ Drive program (C/S/S+)

If you have restricted the shift range, the transmission position and the selected shift range, e.g. D3, are shown at position ①.

Display when in transmission position D and drive program M

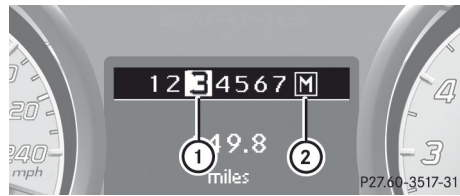

- ① Gear
- ② Drive program

Transmission positions

P Park position

Do not shift the transmission into position **P** unless the vehicle is stationary. The parking lock should not be used as a brake when parking. In addition to engaging the parking lock, you must always apply the electric parking brake to secure the vehicle.

If the vehicle electronics are malfunctioning, the transmission may be locked in position **P**.

Have the vehicle electronics checked at a qualified specialist workshop, e.g. an authorized Mercedes-Benz Center, immediately.

R Reverse gear

Only shift the transmission to **R** when the vehicle is stationary.

N**Neutral**

No power is transmitted from the engine to the drive wheels.

Releasing the brakes will allow you to move the vehicle freely, e.g. to push it.

Do not shift the transmission to **N** while driving. The transmission could otherwise be damaged.

If ESP® is deactivated or faulty: only shift the transmission to position **N** if the vehicle is in danger of skidding, e.g. on icy roads.

D**Drive**

The transmission shifts into drive programs C/S/S+ automatically. All forward gears are available.

Changing gear

The transmission shifts into individual gears automatically. This is determined by:

- drive position **D**
- the selected drive program (**C/S/S+**)
- the position of the accelerator pedal
- the road speed
- a shift range restriction, if selected

The shift points primarily depend on:

- the position of the accelerator pedal:
 - little throttle: early upshifts; high throttle: late upshifts
- the driving dynamics

A dynamic driving style with high longitudinal and lateral acceleration delays the shift points to higher engine speeds.

Driving tips**Double-clutch function**

When shifting down, the double-clutch function is active regardless of the currently selected drive program. The double-clutch

function reduces the load change reaction on the drive axle. The sound generated by the double-clutch function depends on the drive program selected.

Kickdown

- i** Kickdown is not available in manual drive program **M**.

Use kickdown for maximum acceleration.

- ▶ Depress the accelerator pedal beyond the pressure point.
 - Depending on the selected drive program, the transmission shifts to the lowest gear allowing ideal acceleration.

Working on the vehicle**⚠ WARNING**

When working on the vehicle, engage the electric parking brake and shift the automatic transmission into park position **P**. Otherwise, the vehicle could roll away and cause an accident and/or serious injuries.

Drive program selector

With the drive program selector switch, you can choose from a range of different transmission configurations or select the RACE START drive mode.

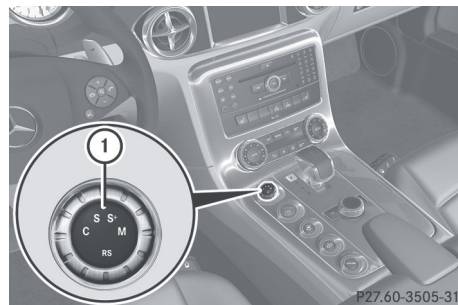

P27.60-3505-31

Drive program	Characteristic
C Controlled Efficiency	Comfort-oriented, optimum-economy engine and transmission settings
S Sport	Sporty engine and transmission settings
S+ SportPlus	Extremely sporty engine and transmission settings
M Manual	Manual gearshifting
Driving mode	
RS RACE START	Optimal vehicle acceleration from a standstill

- ▶ Turn drive program selector switch ① until the desired drive program is shown in the multifunction display.

i **RS** cannot be selected during normal driving. For further information on RACE START, see (▷ page 123).

Steering wheel paddle shifters

In transmission position **D**, you can use the steering wheel paddle shifters to restrict or derestrict the transmission shift range. One of the automatic drive programs, **C**, **S** or **S+**, must be selected in order to do so.

In manual drive program **M**, you need to change gear yourself using the steering wheel paddle shifters. At low engine speeds, the transmission shifts down automatically.

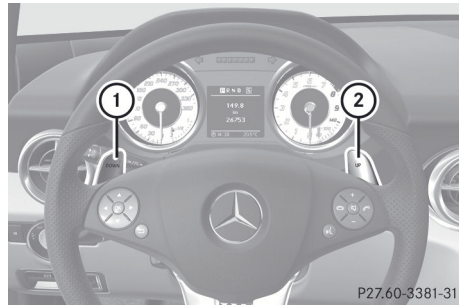

- ① Left steering wheel paddle shifter (DOWN): shift down/restrict shift range
 ② Right steering wheel paddle shifter (UP): shift up/derestrict shift range

RACE START

RACE START facilitates optimum vehicle acceleration from a standstill if the road surface offers suitable grip.

WARNING

RACE START is only available when SPORT handling mode is activated. SPORT handling mode will only be able to stabilize the vehicle to a limited degree if the vehicle starts to skid or a wheel starts to spin. The vehicle is therefore harder to control at the threshold range. You could lose control of the vehicle and cause an accident.

RACE START must only be used on closed off circuits. Always adapt your driving style to suit the prevailing road and weather conditions.

Conditions for activation

You can activate RACE START if:

- the doors are closed.
- the engine is running and the engine and transmission are at operating temperature (▷ page 160).
- SPORT handling mode is switched on (▷ page 58).
- the steering wheel is in the straight-ahead position.

- the vehicle is stationary and the brake pedal is depressed (left foot).
- the transmission is set to **D**.

Activating RACE START

- ▶ Depress the brake pedal with your left foot and keep it depressed.
- ▶ Turn the drive program selector switch clockwise (▷ page 122) until the **RS** indicator on the switch lights up in red. The **RACE START Confirm: Paddle UP Cancel: Paddle DOWN** message appears in the multifunction display.

- ❗ If the conditions for activation are not fulfilled, RACE START is canceled. The **RACE START Not Possible** message appears in the multifunction display.
- ▶ **To cancel:** pull the left-hand steering wheel paddle shifter (DOWN) (▷ page 123). The multifunction display shows the **RACE START Canceled** message.
- ▶ **To confirm:** pull the right-hand steering wheel paddle shifter (UP) (▷ page 123). The **RACE START Available Depress gas pedal** message appears in the multifunction display.
- ❗ If you do not depress the accelerator pedal within a few seconds, RACE START is canceled. The multifunction display shows the **RACE START Canceled** message.
- ▶ Fully depress the accelerator pedal. The engine speed is increased. The **RACE START Release brake to start.** message appears in the multifunction display.
- ❗ If you do not release the brake pedal within a few seconds, RACE START is canceled. The multifunction display shows the **RACE START Canceled** message.
- ▶ Take your foot off the brake pedal while keeping the accelerator pedal fully depressed. The vehicle pulls away at maximum acceleration.

The **RACE START Active** message appears in the multifunction display.

RACE START is deactivated once a speed of approximately 50 km/h is reached. Drive program **S+** is activated. SPORT handling mode remains switched on.

RACE START is immediately deactivated if you take your foot off the accelerator pedal during RACE START or if the conditions for activation are no longer met. The **RACE START Not Possible** or **RACE START Canceled** message appears in the multifunction display.

- ❗ After using it several times in short succession, RACE START will be unavailable until a certain distance has been driven.

Automatic drive program

Drive program **C** is characterized by the following:

- comfort-oriented engine and transmission settings
- optimal fuel consumption resulting from the transmission shifting up sooner
- the vehicle pulling away more gently in forward and reverse gears, unless the accelerator pedal is depressed fully
- increased sensitivity; this improves driving stability on slippery road surfaces, for example
- the transmission shifting up sooner; this results in the vehicle being driven at lower engine speeds and the wheels being less likely to spin

Drive programs **S** and **S+** are characterized by the following:

- sporty engine and transmission settings
- the transmission shifting up later and shifting down dynamically

- as a result of the later transmission upshifts, the fuel consumption may be higher
- if a period of dynamic driving is followed by an extended phase with a constant accelerator pedal position, the vehicle shifts up to a higher gear. This optimizes fuel consumption

If a gentle driving style is adopted in automatic drive programs C/S/S+, the drive program settings are adjusted to optimize fuel consumption. Depending on the operating conditions, the transmission shifts to a higher gear.

Shift ranges

Introduction

In certain driving situations, it is recommended to restrict the shift range. The set shift range appears in the instrument cluster's multifunction display (> page 121). The transmission only shifts to the gear displayed in the instrument cluster.

When the maximum engine speed is reached, the transmission shifts up a gear in the automatic programs C/S/S+. Gear restriction is correspondingly increased by one gear.

	Driving situation
3	The braking effect of the engine can be utilized in this position
2	To use the braking effect of the engine on downhill gradients and for driving: <ul style="list-style-type: none"> • on steep mountain roads • in mountainous terrain • in arduous conditions
1	To use the braking effect of the engine on extremely steep downhill gradients and on long downhill stretches

Derestricting the shift range/shifting up

- ▶ Pull the right steering wheel paddle (UP). The shift range is derestricted. If you are driving in manual drive program **M**, the transmission shifts up to the next gear.

Restricting the shift range/shifting down

WARNING

Do not change down for additional engine braking on a slippery road surface. This could cause the drive wheels to lose their grip and the vehicle could skid.

- ▶ Pull the left steering wheel paddle (DOWN). The transmission shifts down one gear and restricts the shift range to this gear. If the engine speed in manual drive program **M** is too high, it is not possible to shift down. The two red segments in the instrument cluster flash if you pull the left-hand steering wheel paddle shifter (DOWN) (> page 126).

Clearing the shift range restriction

- ▶ Pull the right-hand steering wheel paddle shifter (UP) until the number for the gear disappears from the multifunction display.

or

- ▶ Use the E-SELECT lever to shift the transmission to position **D**. The transmission shifts from the current shift range directly to **D**.

Selecting the ideal shift range

- ▶ Pull the left-hand steering wheel paddle shifter repeatedly until the function is activated. Depending on the selected drive program, the transmission shifts to a gear which allows ideal acceleration and deceleration. To do this, the transmission shifts down one or more gears.

Manual drive program

In manual drive program **M**, you need to change gear yourself using the steering wheel paddle shifters (▷ page 123). The transmission only shifts down automatically at low engine speeds depending on the respective gear.

! In manual drive program **M**, the transmission does not shift up automatically even when the engine limiting speed for the current gear is reached. When the engine limiting speed is reached, the fuel supply is cut to prevent the engine from overrevving. Always make sure that the engine speed does not reach the red area of the tachometer and observe the upshift indicator. There is otherwise a risk of engine damage.

- ▶ **To activate the manual drive program:** turn the drive program selector switch until **M** appears in the instrument cluster's multifunction display.
M lights up in red on the drive program selector switch.
- ▶ **To deactivate the manual drive program:** turn the drive program selector switch and select another drive program.

Upshift indicator

The upshift indicator is a four-stage display designed to assist you in sporty driving.

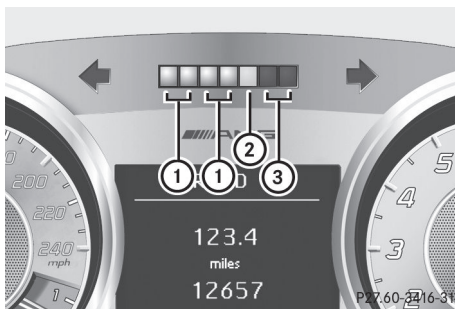

The upshift indicator allows you to recognize the ideal shift point for dynamic acceleration.

White segments ① and yellow segment ② light up in succession from left to right.

When red segments ③ light up and the "up" message appears in the multifunction display, the ideal shift point has been reached:

- ▶ Shift up using the right-hand steering wheel paddle shifter (UP) as quickly as possible. The vehicle shifts up to the next gear.
- i** If you continue to increase the engine speed without shifting up in time, the fuel supply is shut off to protect the engine. This results in abruptly reduced acceleration.

Display for downshift override

If the engine speed is too high, you cannot shift down with the left steering wheel paddle shifter. If you then pull the left steering wheel paddle shifter, both red segments ③ light up briefly.

AMG button (SETUP)

With the AMG button, you can call up and store a default drive program setting and the default suspension tuning.

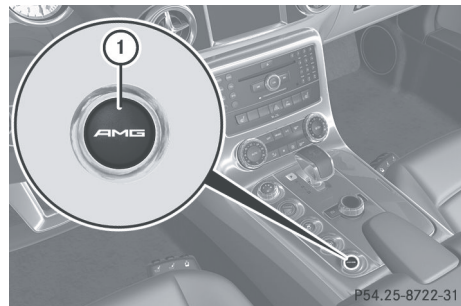

P54.25-8722-31

- ▶ **To store:** press and hold AMG button ① until you hear a tone.
- ▶ **To call up:** press AMG button ①. The stored drive program is selected.
- ▶ **To display:** briefly press AMG button ①. The multifunction display shows the SETUP in the AMG menu (▷ page 160).

Refueling

Important safety notes

WARNING

Gasoline is highly flammable and poisonous. It burns violently and can cause serious personal injury.

Never allow sparks, flames or smoking materials near gasoline.



Turn off the engine before refueling.

Whenever you are around gasoline, avoid inhaling fumes and any skin or clothing contact.

Direct skin contact with fuels and the inhalation of fuel vapors are damaging to your health.

WARNING

Overfilling of the fuel tank may create pressure in the system which could cause a gas discharge. This could cause the gasoline to spray back out when removing the fuel pump nozzle, which could cause personal injury.

-  Do not use diesel to refuel vehicles with a gasoline engine. Even small amounts of diesel will cause damage to the injection system. Damage caused by adding diesel is not covered by the Limited Warranty.
-  Do not switch on the ignition if you accidentally refuel with the wrong fuel. Otherwise, the fuel will enter the fuel lines. Notify a qualified specialist workshop and

have the fuel tank and fuel lines drained completely.

Gasoline (EN 228)

Fuel grade

 You should only refuel with unleaded premium-grade gasoline as this avoids damaging the catalytic converter. If engine running problems are apparent, have the cause checked immediately and repaired. Excess unburned fuel can otherwise enter the catalytic converter, leading to overheating and possibly causing a fire.

 Only refuel with premium-grade unleaded gasoline with a specified minimum octane number of 91 (average value of 96 RON/ 86 MON).

You will usually find information about the fuel grade on the pump. If you cannot find the label on the pump, ask the staff for assistance.

Further information can be found:

- in the "Technical data" section (▷ page 280)
- at any Mercedes-Benz Service Center or
- online at <http://www.mbusa.com>⁸

Refueling

Fuel filler flap

When you open or close the vehicle with the SmartKey, the fuel filler flap is automatically unlocked or locked.

The fuel filler flap is located to the rear on the right. The position of the fuel filler cap is displayed in the instrument cluster . The arrow next to the filling pump indicates the side of the vehicle.

⁸ USA only.

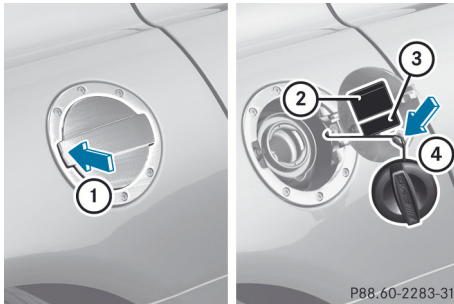

- ① To open the fuel filler flap
- ② Tire pressure table
- ③ Fuel type
- ④ To insert the fuel filler cap

Opening

- ▶ Switch off the engine.
- i** When the engine is running and the fuel filler flap is open, the engine diagnostics warning lamp  may light up. Further information can be found in the "Warning and indicator lamps in the instrument cluster" chapter (▷ page 194).
- ▶ Open the driver's door. This switches the ignition to position **0**, which corresponds to having removed the SmartKey. The driver's door can be closed again.
- ▶ Press the fuel filler flap in the direction of arrow ①. The fuel filler flap opens slightly.
- ▶ Open the fuel filler flap.
- ▶ Turn the fuel filler cap counter-clockwise and remove it.
- ▶ Insert the fuel filler cap into the holder bracket on the inside of filler flap ④.
- ▶ Completely insert the fuel pump nozzle into the filler neck and refuel.
- ▶ Only fill the tank until the pump nozzle switches off.
- !** Overfilling the fuel tank could damage the fuel system.

Closing

- ▶ Replace the fuel filler cap and turn it clockwise. The fuel filler cap audibly engages.
- ▶ Close the fuel filler flap.

Problems with fuel and the fuel tank

Problem	Possible causes/consequences and ► Solutions
Fuel is leaking from the vehicle.	<p> Risk of explosion or fire</p> <p>The fuel line or the fuel tank is defective.</p> <ul style="list-style-type: none"> ► Set the Start/Stop button to key position 0 immediately. ► Do not restart the engine under any circumstances. ► Consult a qualified specialist workshop.
The fuel filler flap cannot be opened.	<p>The fuel filler flap is not unlocked.</p> <p>or</p> <p>The SmartKey battery is discharged.</p> <ul style="list-style-type: none"> ► Unlock the vehicle (▷ page 69). <p>or</p> <ul style="list-style-type: none"> ► Unlock the vehicle using the mechanical key (▷ page 71). <p>The fuel filler flap is unlocked, but the opening mechanism is jammed.</p> <ul style="list-style-type: none"> ► Consult a qualified specialist workshop.

Parking

Important safety notes

 **WARNING**

Do not park this vehicle in areas where combustible materials can come into contact with the hot exhaust system. Combustible materials, such as grass, hay or leaves could be ignited by the hot exhaust system and cause a vehicle fire. Do not park the vehicle on dry grassland or harvested grain fields.

Unintended vehicle movement can cause serious personal injury or damage to the vehicle or the vehicle drivetrain. To reduce such risks, always do the following before turning off the engine and leaving the vehicle:

- keep your right foot on the brake pedal.
- engage the electric parking brake.
- shift the transmission into park position **P**.
- slowly release the brake pedal.
- when parked on an incline, always turn the front wheels towards the road curb.

- turn the SmartKey in the ignition lock to position **0** and remove the SmartKey from the ignition lock, or press the Start/Stop button.
- take the SmartKey with you and lock the vehicle when leaving.

 Do not open the driver's door while the vehicle is in motion. At low speeds in transmission position **D** or **R**, park position **P** is otherwise engaged automatically. This can damage the transmission.

If you wish to maneuver the vehicle with the door open, proceed as follows:

- Bring the vehicle to a standstill.
- Use the E-SELECT lever to shift the transmission to position **N** or press the **P** button on the center console.
- Open the driver's door.
You can maneuver the vehicle with the driver's door open.

Switching off the engine

Important safety notes

WARNING

If the engine is not running, there is no power assistance for the steering and brakes. Steering and braking then requires significantly greater effort.

As a result, you could cause an accident and injure yourself and others.

Therefore, do not switch off the engine while you are driving.

-  Do not open the driver's door while the vehicle is in motion. At low speeds in transmission position **D** or **R**, park position **P** is otherwise engaged automatically. This can damage the transmission.



-  Observe the display messages in the instrument cluster.

AMG SPEEDSHIFT DCT 7-gear sport transmission

- ▶ Use the button on the center console to shift the transmission to **P**.

Using the Start/Stop button

- ▶ Press the Start/Stop button (▷ page 115). The engine stops and all the indicator lamps in the instrument cluster go out.
- ▶ Apply the electric parking brake.

-  If you switch the engine off with the transmission in position **R** or **D**, the transmission automatically shifts to **N**. If you move the E-SELECT lever to **N** before switching off the engine, the transmission remains in **N** for approximately 30 minutes. If you open the driver's or front-passenger door during this period, the transmission automatically shifts to **P**.
-  The engine can be turned off while the vehicle is in motion by pressing and holding the Start/Stop button for three seconds.

Using the SmartKey

-  Do not remove the SmartKey while the vehicle is in motion. At low speeds, park position **P** will otherwise be engaged automatically.

Do not open the driver's door while the vehicle is in motion. At low speeds, transmission position **P** is engaged automatically.

This can damage the transmission.

- ▶ Turn the SmartKey to position **O** in the ignition lock and remove it. The parking lock is activated.
- ▶ Apply the electric parking brake.

-  If you use the E-SELECT lever to shift the transmission to **N** before switching off the engine, the transmission remains in **N** for approximately 30 minutes. If you open the driver's or front-passenger door during this period, the transmission automatically shifts to **P**.

If the SmartKey is in the ignition lock and you use the E-SELECT lever to shift the transmission to **N** before switching off the engine, the transmission remains in **N**. This still applies if you open the driver's or front-passenger door. Further information is available in the "Car wash" section (▷ page 223).

Electric parking brake

General information

WARNING

When you leave the vehicle, you should always remove the SmartKey from the ignition and take it with you, remembering to lock the vehicle. Do not leave children unattended in the vehicle and do not give them access to the unlocked vehicle. The children could release the parking brake and/or shift the transmission out of park position **P**. In both cases this could cause an accident and/or serious injury.



Applying/releasing manually

- ▶ **To apply:** press handle ①.

The red **PARK** (USA only) or **(P)** (Canada only) indicator lamp in the instrument cluster lights up.

- ❗ The electric parking brake can also be applied when the SmartKey is in position **0**.
- ▶ Pull handle ①.
The red **PARK** (USA only) or **(P)** (Canada only) indicator lamp in the instrument cluster goes out.
- ❗ The electric parking brake can only be released when the ignition is switched on using the Start/Stop button.

Releasing the electric parking brake automatically

The electric parking brake is released automatically when the following conditions are simultaneously fulfilled:

- the engine is running.
- the transmission is in position **D** or **R**.
- the hood is closed.
- your seat belt is fastened.
- you depress the accelerator pedal.

If the transmission is in position **R**, the trunk lid must be closed.

For the parking brake to be released automatically if your seat belt is not fastened, the following conditions must be fulfilled:

- the driver's door is closed.
- you have shifted out of **P** or you have previously driven faster than 2 mph (3 km/h).

Emergency braking

The vehicle can also be braked during an emergency by using the electric parking brake.

- ▶ While driving, push handle ① of the electric parking brake (▷ page 130).

- ❗ The vehicle is braked as long as you keep the handle of the electric parking brake pressed. The longer the electric parking brake handle is depressed, the greater the braking force.

During braking:

- a warning tone sounds.
- the **Release parking brake** message appears.
- the red **PARK** (USA only) or **(P)** (Canada only) indicator lamp in the instrument cluster lights up.

When the vehicle has been braked to a standstill, the electric parking brake is engaged.

Parking the vehicle for a long period

If you leave the vehicle parked for longer than four weeks, the battery may be damaged by exhaustive discharging.

- ▶ Connect the battery to the charge maintenance socket of a trickle charger.
- ❗ You can obtain information about trickle chargers from a qualified specialist workshop.

If you leave the vehicle parked for longer than six weeks, the vehicle may suffer damage as a result of lack of use.

- ▶ Visit a qualified specialist workshop and seek advice.

Driving tips

General driving tips

Important safety notes

WARNING

Please do not forget that your primary responsibility is to drive the vehicle. A driver's attention to the road must always be his/her primary focus when driving. For your safety and the safety of others, we recommend that you pull over to a safe location and stop before placing or taking a telephone call.

If you choose to use the telephone⁹ while driving, please use the hands-free device and only use the telephone when road, weather and traffic conditions permit. Some jurisdictions prohibit the driver from using a mobile telephone while driving a vehicle.

Only operate the COMAND⁹ (Cockpit Management and Data System) if road, weather and traffic conditions permit. Otherwise, you may not be able to observe traffic conditions and could endanger yourself and others.

Bear in mind that at a speed of just 30 mph (approximately 50 km/h), your vehicle is covering a distance of 44 feet (approximately 14 m) every second.

Drive sensibly – save fuel

Observe the following tips to save fuel:

- ▶ The tires should always be inflated to the recommended tire pressure.
- ▶ Remove unnecessary loads.
- ▶ Warm up the engine at low engine speeds.
- ▶ Avoid frequent acceleration or braking.
- ▶ Have all maintenance work carried out according to the service intervals listed in

the Maintenance Booklet or the service interval display.

Fuel consumption also increases when driving in cold weather, in stop-and-go traffic and in mountainous terrain.

Drinking and driving

WARNING

Drinking and driving and/or taking drugs and driving are very dangerous combinations. Even a small amount of alcohol or drugs can affect your reflexes, perceptions and judgment.

The possibility of a serious or even fatal accident are greatly increased when you drink or take drugs and drive.

Do not drink or take drugs and drive or allow anyone to drive who has been drinking or taking drugs.

Pedals

WARNING

Make sure absolutely no objects are obstructing the pedals' range of movement. Keep the driver's footwell clear of all obstacles. If there are any floor mats or carpets in the footwell, make sure that the pedals still have sufficient clearance.

During sudden driving or braking maneuvers, the objects could get caught between the pedals. You could then no longer brake or accelerate. This could lead to accidents and injury.

Rolling with the engine switched off

WARNING

There is no power assistance for the steering and the brake when the engine is not running. Steering and braking requires significantly more effort and you could lose control of the vehicle and cause an accident as a result.

⁹ Observe all legal requirements.

Do not turn off the engine while the vehicle is in motion.

Exhaust check

WARNING

Inhalation of exhaust gas is hazardous to your health. All exhaust gas contains carbon monoxide (CO), and inhaling it can cause unconsciousness and possible death.

Do not run the engine in confined areas (such as a garage) which are not properly ventilated. If you think that exhaust gas fumes are entering the vehicle while driving, have the cause determined and corrected immediately. If you must drive under these conditions, drive only with at least one window fully open at all times.

Certain engine systems are designed to keep the level of poisonous components in exhaust fumes within legal limits.

These systems only work at peak efficiency if they are serviced exactly in accordance with the manufacturer's specifications. For this reason, all work on the engine may only be carried out by qualified and authorized Mercedes-Benz technicians.

The engine settings must not be changed under any circumstances. Furthermore, all specific service work must be carried out at regular intervals and in accordance with the Mercedes-Benz service requirements. Details can be found in the Maintenance Booklet.

Brakes

Important safety notes

WARNING

On slippery road surfaces, never downshift in order to obtain braking action. This could result in drive wheel slip and reduced vehicle control. Your vehicle's ABS will not prevent this type of loss of control.

WARNING

Make sure that you do not endanger other road users when you apply the brakes.

Downhill gradients

! On long and steep gradients, you must reduce the load on the brakes by shifting early to a lower gear. This allows you to take advantage of the engine braking effect and helps avoid overheating and excessive wear of the brakes.

When you take advantage of the engine braking effect, a drive wheel may not turn for some time, e.g. on a slippery road surface. This could cause damage to the drive train. This type of damage is not covered by the Mercedes-Benz warranty.

Heavy and light loads

WARNING

Depressing the brake pedal constantly results in excessive and premature wear to the brake pads.

It may also cause the brakes to overheat, seriously impairing their effectiveness. It may then not be possible to stop the vehicle in sufficient time to avoid an accident.

If the brakes have been subjected to a heavy load, do not stop the vehicle immediately, but drive on for a short while. This allows the airflow to cool the brakes more quickly.

Wet roads

WARNING

After driving in heavy rain for some time without applying the brakes or through water deep enough to wet brake components, the first braking action may be somewhat reduced. You have to depress the brake pedal more firmly. Maintain a safe distance from vehicles in front.

After driving on a wet road or having the vehicle washed, brake firmly while paying

attention to the traffic conditions. This will warm up the brake discs, thereby drying them more quickly and protecting them against corrosion.

Limited braking performance on salt-treated roads

WARNING

The layer of salt on the brake discs and the brake pads/linings may cause a delay in the braking effect, resulting in a significantly longer braking distance, which could lead to an accident.

To avoid this danger, you should:

- occasionally brake carefully, without putting other road users at risk, when you are driving on salted roads. This helps to remove any salt that may have started to build up on the brake discs and the brake pads/linings.
- maintain a greater distance to the vehicle ahead and drive with particular care.
- carefully apply the brakes at the end of a trip and immediately after commencing a new trip, so that salt residues are removed from the brake discs.

Servicing the brakes

WARNING

If brake pads or brake fluid other than those recommended are used, the braking properties of the vehicle can be degraded to an extent that safe braking is substantially impaired. This could result in an accident.

WARNING

Make sure that you do not endanger other road users when you apply the brakes.

- ❗ If the red brake warning lamp lights up in the instrument cluster and you hear a warning tone while the engine is running, the brake fluid level may be too low. Observe additional warning messages in the multifunction display.

The brake fluid level may be too low due to brake pad wear or leaking brake lines.

Have the brake system checked immediately. This work should be carried out at an authorized Mercedes-Benz Center.

- ❗ As the ESP® system operates automatically, the engine and the ignition must be switched off (the SmartKey must be in position **0** or **1** in the ignition lock or the Start/Stop button must be in position **0** or **1**) if:

- the electric parking brake is tested using a brake dynamometer.
- the vehicle is towed with one axle raised.

Braking triggered automatically by ESP® may seriously damage the brake system.

All checks and maintenance work on the brake system must be carried out at a qualified specialist workshop. Have this work carried out at an authorized Mercedes-Benz Center.

Have the brake pads replaced and the brake fluid renewed at a qualified specialist workshop, e.g. an authorized Mercedes-Benz Center.

If your brake system is subject only to moderate loads, you should test the functionality of your brakes at regular intervals by pressing firmly on the brake pedal at high speeds. This improves the grip of the brake pads.

You can find a description of Brake Assist (BAS) on (> page 55).

AMG high-performance composite brake system

WARNING

New vehicle brake pads and discs, and replacement brake pads and discs may take several hundred miles of driving until they provide optimum braking efficiency. Until that time, you may need to use increased brake pedal pressure while braking. Please be aware

of this and adjust your driving and braking accordingly during this break-in period.

Excessive high-demand braking will cause correspondingly high brake wear. Please be attentive to the brake warning lamp in the instrument cluster and brake condition messages in the multifunction display. Especially for high performance driving, it is important to maintain and have the brake system checked regularly.

The AMG high-performance compound brake system and the AMG ceramic high-performance compound brake system are designed for high loads. This may lead to noise when braking. This will depend on:

- speed
- braking force
- environmental conditions, such as temperature and humidity

The wear of individual components of the brake system, such as the brake pads/linings or brake discs, depends on the individual driving style and operating conditions.

For this reason, it is impossible to state a mileage that will be valid under all circumstances. An aggressive driving style will lead to high wear. You can obtain further information about this from your authorized Mercedes-Benz Center.

Driving on wet roads

Hydroplaning

If water has accumulated to a certain depth on the road surface, there is a danger of hydroplaning occurring, even if:

- you drive at low speeds.
- the tires have adequate tread depth.

For this reason, in the event of heavy rain or in conditions in which hydroplaning can occur, you must drive in the following manner:

- lower your speed.
- avoid ruts.
- brake carefully.

Driving on flooded roads

! Do not drive through flooded areas. Check the depth of any water before driving through it. Drive slowly through standing water. Otherwise, water may enter the vehicle interior or the engine compartment. This can damage the electronic components in the engine or the automatic transmission. Water can also be drawn in by the engine's air suction nozzles and this can cause engine damage.

Winter driving

Please bear the following in mind

WARNING

If the vehicle becomes trapped in snow, ensure that snow is kept away from the exhaust pipe and from around the vehicle as long as the engine is running. Otherwise, poisonous carbon monoxide (CO) may enter the vehicle, resulting in loss of consciousness and even death.

To assure sufficient fresh air ventilation, open a window slightly on the side of the vehicle not facing the wind.

At the onset of winter, have your vehicle winterproofed at a qualified specialist workshop, e.g. at an authorized Mercedes-Benz Center.

Observe the notes in the "Winter operation" section (> page 252).

Summer tires

Observe the notes in the "Winter operation" section (▷ page 252).

Slippery road surfaces

WARNING

The outside temperature indicator is not designed to serve as an ice-warning device and is therefore unsuitable for that purpose. Indicated temperatures just above the freezing point do not guarantee that the road surface is free of ice. The road may still be icy, especially in wooded areas or on bridges.

WARNING

On slippery road surfaces, never downshift in order to obtain braking action. This could result in drive wheel slip and reduced vehicle control. Your vehicle's ABS will not prevent this type of loss of control.

Drive particularly carefully on slippery road surfaces. Avoid sudden acceleration, steering and braking maneuvers. Do not use cruise control.

If the vehicle threatens to skid or cannot be stopped when moving at low speed:

▶ Shift the transmission to position **N**.

 For more information on driving with snow chains, see (▷ page 252).

WARNING

Make sure that you do not endanger other road users when you apply the brakes.

Driving systems

Cruise control

Important safety notes

Cruise control maintains a constant road speed for you. It brakes automatically in order to avoid exceeding the set speed. On long and steep downhill gradients, especially if the

vehicle is laden, you must select shift range **1**, **2** or **3** in good time. By doing so, you will make use of the braking effect of the engine, which relieves the load on the brake system and prevents the brakes from overheating and wearing too quickly.

Use cruise control only if road and traffic conditions make it appropriate to maintain a steady speed for a prolonged period. You can set any road speed above 20 mph (30 km/h).

WARNING

The cruise control is a convenience system designed to assist the driver during vehicle operation. The driver is and must always remain responsible for the vehicle's speed and for safe brake operation.

Only use the cruise control if the road, traffic, and weather conditions make it advisable to travel at a constant speed.

- The use of the cruise control can be dangerous on winding roads or in heavy traffic because conditions do not allow safe driving at a constant speed.
- The use of the cruise control can be dangerous on slippery roads. Rapid changes in tire traction can result in wheel spin and loss of control.
- Deactivate the cruise control when driving in fog.

The "Resume" function should only be operated if the driver is fully aware of the previously set speed and wishes to resume this particular preset speed.

WARNING

The cruise control brakes automatically so that the set speed is not exceeded.

Cruise control lever

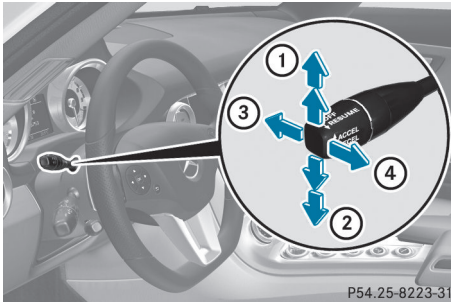

- ① To store the current speed or a higher speed
- ② To store the current speed or a lower speed
- ③ To deactivate cruise control
- ④ To store the current speed or to call up the last stored speed

When you activate cruise control, the stored speed is shown in the lower section of the multifunction display.

Storing and maintaining the current speed

You can store the current speed if you are driving faster than 20 mph (30 km/h).

- ▶ Accelerate the vehicle to the desired speed.
- ▶ Briefly press the cruise control lever up ① or down ② to the pressure point.
- ▶ Remove your foot from the accelerator pedal.
Cruise control is activated. The vehicle automatically maintains the stored speed.

i Cruise control may be unable to maintain the stored speed on uphill gradients. The stored speed is resumed when the gradient evens out. Cruise control maintains the stored speed on downhill gradients by automatically applying the brakes.

Storing the current speed or calling up the last stored speed

WARNING

The set speed stored in memory should only be set again if prevailing road conditions and legal speed limits permit. Possible acceleration or deceleration differences arising from returning to the preset speed could cause an accident and/or serious injury to you and others.

- ▶ Briefly pull the cruise control lever towards you ④.
- ▶ Remove your foot from the accelerator pedal.
The first time cruise control is activated, it stores the current speed or regulates the speed of the vehicle to the previously stored speed.

Setting a speed

WARNING

Keep in mind that it may take a brief moment until the vehicle has made the necessary adjustments.

Increase or decrease the set vehicle speed to a value that the prevailing road conditions and legal speed limits permit. Otherwise, sudden and unexpected acceleration or deceleration of the vehicle could cause an accident and/or serious injury to you and others.

- ▶ Press the cruise control lever to the pressure point, up ① for a higher speed or down ② for a lower speed.
 - ▶ Keep the cruise control lever pressed until the desired speed is reached.
 - ▶ Release the cruise control lever.
The new speed is stored.
- i** Cruise control is not deactivated if you depress the accelerator pedal. For example, if you accelerate briefly to overtake, cruise control adjusts the

vehicle's speed to the last speed stored after you have finished overtaking.

Making adjustments in 1 mph increments

- ▶ Briefly press the cruise control lever to the pressure point, up ① for a higher speed or down ② for a lower speed. The last speed stored is increased or reduced.

Making adjustments in 10 mph increments

- ▶ Briefly press the cruise control lever beyond the pressure point, up ① for a higher speed or down ② for a lower speed. The last speed stored is increased or reduced.

Deactivating cruise control

There are several ways to deactivate cruise control:

- ▶ Briefly press the cruise control lever forwards ③.

or

- ▶ Brake.

Cruise control is automatically deactivated if:

- you press the electric parking brake handle.
- you are driving below 20 mph (30 km/h).
- ESP® intervenes or you deactivate ESP®.
- you shift the transmission to **N** while the vehicle is in motion.

If cruise control is deactivated, you will hear a warning tone. The **Cruise control Off** message is displayed in the multifunction display for approximately five seconds.

- ① The last speed stored is cleared when you switch off the engine.

AMG adaptive sport suspension system

General notes

The electronically controlled damping system works continuously. This improves driving safety and ride comfort.

The damping is tuned individually to each wheel and depends on:

- your driving style, e.g. sporty
- the road surface condition, e.g. bumps
- your individual selection of Sport, Sport + or Comfort

If you select Sport or Sport + mode and restart the engine, the suspension setting reverts to Comfort mode.

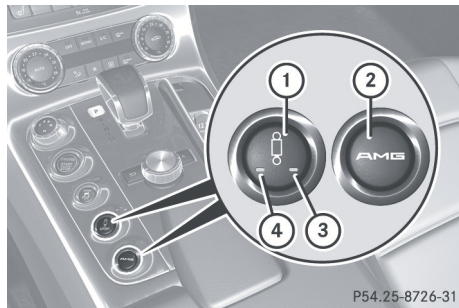

P54.25-8726-31

Sport mode

The firmer suspension tuning in Sport mode ensures even better contact with the road. Select this mode when employing a sporty driving style, e.g. on winding country roads.

- ▶ Press button ① once. Indicator lamp ④ lights up. You have selected Sport mode.

The **AMG Suspension System SPORT** message appears in the multifunction display.

Sport + mode

The very firm setting of the suspension tuning in Sport + mode ensures the best possible

contact with the road. Select this mode only when driving on race circuits.

If indicator lamps ③ and ④ are off:

- ▶ Press button ① twice.
Indicator lamps ③ and ④ light up. You have selected Sport + mode.
The **AMG Suspension System SPORT +** message appears in the multifunction display.

If indicator lamp ④ lights up:

- ▶ Press button ① once.
The second indicator lamp ③ lights up. You have selected Sport + mode.
The **AMG Suspension System SPORT +** message appears in the multifunction display.

Comfort mode

In comfort mode, the driving characteristics of your vehicle are more comfortable. Select this mode if you favor a more comfortable driving style, but also when driving fast on straight roads, e.g. freeways.

- ▶ Press button ① repeatedly until indicator lamps ③ and ④ go out.
You have selected Comfort mode.
The **AMG Suspension System COMFORT** message appears in the multifunction display.

Storing and calling up settings

Once the suspension tuning and drive program have been selected, you can store and call up your settings using AMG button ②.

- ▶ **To store:** press AMG button ② until you hear a tone.
- ▶ **To call up:** press AMG button ②.
The stored suspension tuning and drive program are selected.

- ▶ **To display:** briefly press AMG button ②.
Your selection appears in the multifunction display.

PARKTRONIC

Important safety notes

WARNING

The PARKTRONIC is a supplemental system. It is not intended to, nor does it replace, the need for extreme care. The responsibility during parking and other critical maneuvers always remains with the driver.

WARNING

Make sure no persons or animals are in or near the area in which you are parking/maneuvering. Otherwise, they could be injured.

PARKTRONIC is an electronic parking aid with ultrasonic sensors. It indicates visually and audibly the distance between your vehicle and an object.

PARKTRONIC is activated automatically when you:

- switch on the ignition
- release the electric parking brake

PARKTRONIC is deactivated at speeds above 11 mph (18 km/h). It is reactivated at lower speeds.

PARKTRONIC monitors the area around your vehicle using four sensors in the front bumper and four sensors in the rear bumper.

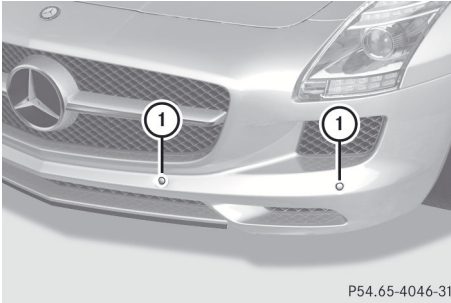

P54.65-4046-31

- ① Sensors in the front bumper, left-hand side (example)

Range of the sensors

General notes

The sensors must be free of dirt, ice and slush. Otherwise, they may not function correctly. Clean the sensors regularly, taking care not to scratch or damage them (> page 228).

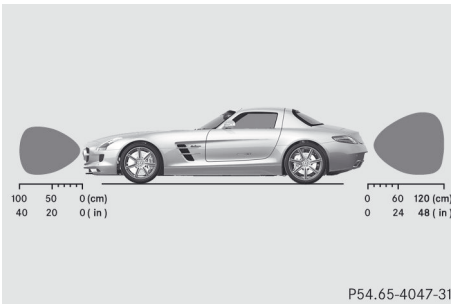

P54.65-4047-31

Example: side view (Coupe)

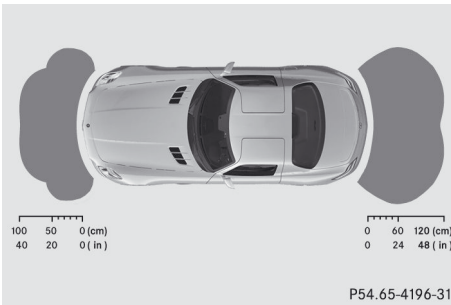

P54.65-4196-31

Example: top view (Coupe)

Front sensors

Center	approximately 40in (approximately 100cm)
Corners	approximately 24in (approximately 60cm)

Rear sensors

Center	approximately 48in (approximately 120cm)
Corners	approximately 32in (approximately 80cm)

⚠ When parking, pay particular attention to objects above or below the sensors, such as flower pots or trailer drawbars. PARKTRONIC does not detect such objects when they are in the immediate vicinity of the vehicle. You could damage the vehicle or the objects.

The sensors may not detect snow and other objects that absorb ultrasonic waves.

Ultrasonic sources such as an automatic car wash, the compressed-air brakes on a truck or a pneumatic drill could cause PARKTRONIC to malfunction.

PARKTRONIC may not function correctly on uneven terrain.

Minimum distance

Center	approximately 12in (approximately 30cm)
Corners	approximately 12in (approximately 30cm)

If there is an obstacle within this range, the relevant warning displays light up and a warning tone sounds. If the distance falls below the minimum, the distance may no longer be shown.

Warning displays

The warning displays show the distance between the sensors and the obstacle. The warning display for the front area is located on the dashboard above the center air vents. The warning display for the rear area is in the rear compartment on the parcel shelf.

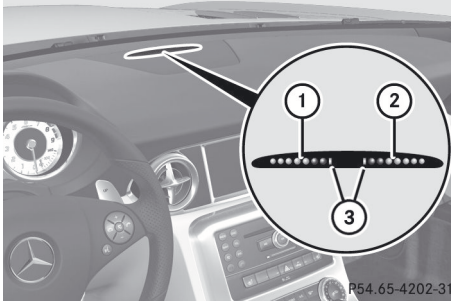

Warning display for the front area

- ① Left-hand side of the vehicle
- ② Right-hand side of the vehicle
- ③ Segments showing operational readiness

The warning display for each side of the vehicle is divided into five yellow and two red segments. PARKTRONIC is operational if yellow segments showing operational readiness ③ light up.

The selector lever position determines which warning display is active while the engine is running:

Transmission position	Warning display
D	Front area activated
R or N	Rear and front areas activated
P	No areas activated

One or more segments light up as the vehicle approaches an obstacle, depending on the vehicle's distance from the obstacle.

From the:

- sixth segment onwards, you will hear an intermittent warning tone for approximately two seconds.
- seventh segment onwards, you will hear a warning tone for approximately two seconds. This indicates that you have now reached the minimum distance.

Deactivating/activating PARKTRONIC

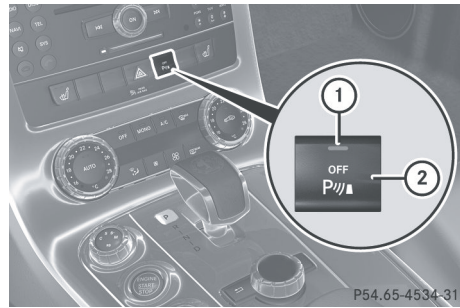

- ① Indicator lamp
- ② To deactivate/activate PARKTRONIC

If indicator lamp ① lights up, PARKTRONIC is deactivated.

- ❗ PARKTRONIC is automatically activated when you switch on the ignition and release the parking brake.

Problems with PARKTRONIC

Problem	Possible causes/consequences and ► Solutions
Only the red segments in the PARKTRONIC warning displays are lit. You also hear a warning tone for approximately two seconds. PARKTRONIC is deactivated after approximately 20 seconds, and the indicator lamp in the PARKTRONIC button lights up.	<p>PARKTRONIC has malfunctioned and has switched off.</p> <p>► If problems persist, have PARKTRONIC checked at a qualified specialist workshop.</p>
Only the red segments in the PARKTRONIC warning displays are lit. PARKTRONIC is deactivated after approximately 20 seconds.	<p>The PARKTRONIC sensors are dirty or there is interference.</p> <p>► Clean the PARKTRONIC sensors (▷ page 228).</p> <p>► Switch the ignition back on.</p> <p>The problem may be caused by an external source of radio or ultrasound waves.</p> <p>► See if PARKTRONIC functions in a different location.</p>

Rear view camera

Important safety notes

The rear view camera is an optical parking aid. It shows the area behind your vehicle in the COMAND display.

WARNING

Make sure no persons or animals are in or near the area in which you are parking/maneuvering. Otherwise, they could be injured.

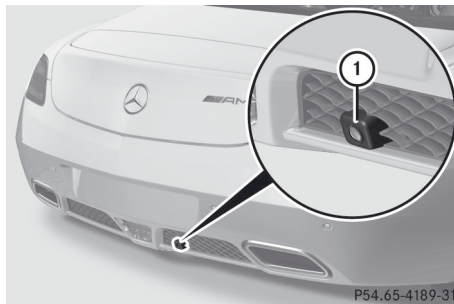

View through the camera

The area behind the vehicle is displayed as a mirror image, as in the rear-view mirror.

⚠ WARNING

The rear view camera is only an aid, and may display obstacles:

- from a distorted perspective
- incorrectly
- not at all.

The rear view camera does not relieve you of the responsibility to take care. Take all necessary care and pay particular attention to the traffic conditions. The rear view camera may not show objects that:

- are very near to the rear bumper
- are underneath the rear bumper

You are responsible for safety at all times and must continue to pay attention to your immediate surroundings when parking and maneuvering. This includes the area behind, in front of, and next to the vehicle. You could otherwise put yourself and/or others in danger.

⚠ WARNING

The rear view camera does not work or does not work properly if:

- it is raining heavily or if it is snowing or foggy.
- it is night or if you are parking/ maneuvering your vehicle in a very dark area.
- very bright white light is shining on the camera.
- the immediate vicinity is illuminated with fluorescent light (the display of the COMAND system can flicker).
- the temperature changes abruptly, for example if you drive out of the cold into a heated garage (condensation on the lens).
- the camera lens is dirty or covered.
- the rear of your vehicle is damaged.

In this case, have the position and the setting of the camera checked at a specialist workshop. Mercedes-Benz recommends that you consult a Mercedes-Benz Center for this purpose.

Do not use the rear view camera in these situations. You could otherwise injure yourself and other people and/or cause damage - including damage to your vehicle - while parking/maneuvering.

Activating the rear view camera

- ▶ Ensure that key position **2** has been selected with the Start/Stop button.
- ▶ Make sure that the "rear view camera" function is selected in COMAND (see the separate operating instructions for COMAND).
- ▶ Engage reverse gear.
The COMAND display shows the area behind the vehicle.

You can also switch off the display of the area behind the vehicle in the COMAND display.

Blind Spot Assist**Important safety notes**

Blind Spot Assist uses a radar sensor system to monitor the areas on both sides of your vehicle. It assists you from a speed of approximately 20 mph (30 km/h). A warning display in the exterior mirrors draws your attention to vehicles detected in the monitored area. If you then switch on the corresponding turn signal to change lane, you will also receive an optical and audible collision warning. For this purpose, Blind Spot Assist uses sensors in the rear bumper.

⚠ WARNING

Blind Spot Assist is only an aid designed to assist driving. It may fail to detect some vehicles and is no substitute for attentive driving.

Blind Spot Assist cannot detect road and traffic conditions. It may fail to detect narrow vehicles, such as motorcycles or bicycles, or may only detect them too late.

Monitoring may be affected by dirty sensors, strong spray or poor visibility caused by snow,

rain or mist, for example. In this case, vehicles are detected late or not at all.

Always pay attention to traffic conditions and your surroundings. Otherwise, you may fail to recognize dangers in time, cause an accident and injure yourself and others.

i USA only:

This device has been approved by the FCC as a “Vehicular Radar System”. The radar sensor is intended for use in an automotive radar system only. Removal, tampering, or altering of the device will void any warranties, and is not permitted by the FCC. Do not tamper with, alter, or use in any non-approved way.

Any unauthorized modification to this device could void the user’s authority to operate the equipment.

Monitoring range of the sensors

Blind Spot Assist monitors the area illustrated up to 10 ft (3 m) behind and directly next to your vehicle.

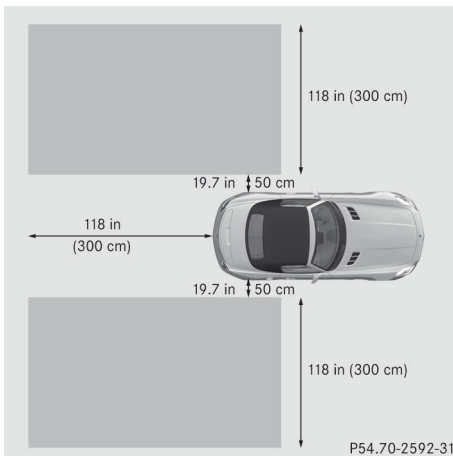

Example (Roadster)

⚠ WARNING

Blind Spot Assist monitors certain areas in the immediate vicinity of your vehicle. Vehicles that approach and drive past at high speeds

are not detected. There is no display and no warning.

If the lanes are very wide, it may not be possible to monitor the complete width of the neighboring lane. For this reason, vehicles in the next lane may not be detected, especially if they are driving in a staggered formation. This may be the case if vehicles are driving at that edge of their lane which is furthest away from your vehicle.

Always pay attention to traffic conditions and your surroundings. Otherwise, you may fail to recognize dangers in time, cause an accident and injure yourself and others.

If the lanes are narrow, vehicles driving in the lane beyond the lane next to your vehicle may be indicated, especially if the vehicles are not driving in the middle of their lane. This may be the case if the vehicles are driving on the inner side of their lane.

Due to the nature of the system:

- warnings may be issued in error when driving close to crash barriers or similar solid lane borders.
- warnings may be interrupted when driving alongside particularly long vehicles, for example trucks, for a prolonged time.

The two sensors for Blind Spot Assist are integrated into the sides of the rear bumper. Make sure that the bumper is free from dirt, ice or slush around the sensors. The radar sensors must not be covered, e.g. by overhanging loads. Following a severe impact or in the event of damage to the bumpers, have the function of the radar sensors checked at a qualified specialist workshop. Blind Spot Assist may otherwise not work properly.

Indicator and warning display

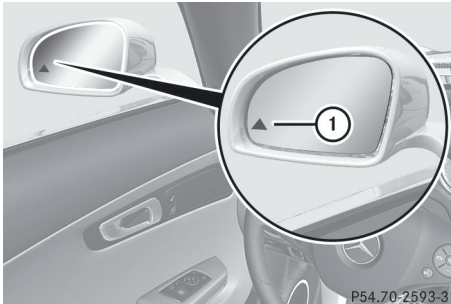

P54.70-2593-31

① Yellow indicator lamp/red warning lamp

When Blind Spot Assist is activated, indicator lamp ① lights up yellow in the exterior mirrors up to a vehicle speed of 20 mph (30 km/h). From a speed of approximately 20 mph (30 km/h) the indicator lamp goes out and Blind Spot Assist is operational.

If a vehicle is detected in the monitoring range of Blind Spot Assist from a speed of approximately 20 mph (30 km/h), warning lamp ① lights up red on the corresponding side. This warning is always given when a vehicle enters the blind spot monitoring range from behind or from the side. When you overtake a vehicle, the warning is only given if difference in speed is less than 7 mph (12 km/h).

The yellow indicator lamp goes out if reverse gear is engaged. In this event, Blind Spot Assist is no longer active.

The brightness of the indicator/warning lamps is adjusted automatically according to the ambient light.

WARNING

Blind Spot Assist is not active at speeds under approximately 20 mph (30 km/h). The indicator lamps in the exterior mirrors are yellow. Vehicles in the monitoring range are then not indicated.

Always pay attention to traffic conditions and your surroundings. Otherwise, you may fail to recognize dangers in time, cause an accident and injure yourself and others.

Collision warning

If a vehicle is detected in the monitoring range of Blind Spot Assist and you switch on the corresponding turn signal, a double warning tone sounds. Red warning lamp ① flashes. If the turn signal remains on, detected vehicles are indicated by the flashing of red warning lamp ①. There are no further warning tones.

Switching on Blind Spot Assist

- ▶ Make sure that Blind Spot Assist (▷ page 156) is activated in the on-board computer.
- ▶ Ensure that key position **2** has been selected with the Start/Stop button. Warning lamps ① light up red in the exterior mirrors for approximately 1.5 seconds and then turn yellow.

Useful information	148
Important safety notes	148
Displays and operation	148

Useful information

- i** This Operator's Manual describes all models and all standard and optional equipment of your vehicle available at the time of publication of the Operator's Manual. Country-specific differences are possible. Please note that your vehicle may not be equipped with all features described. This also applies to safety-related systems and functions.
- i** Please read the information on qualified specialist workshops (▷ page 21).

Important safety notes

You will find an illustration of the instrument cluster in the "At a glance" section (▷ page 27).

WARNING

A driver's attention to the road and traffic conditions must always be his/her primary focus when driving.

For your safety and the safety of others, selecting features through the multifunction steering wheel should only be done by the driver when traffic and road conditions permit it to be done safely.

Bear in mind that at a speed of just 30 mph (approximately 50 km/h), your vehicle is covering a distance of 44 feet (approximately 14 m) every second.

WARNING

No messages will be displayed if either the instrument cluster or the multifunction display is inoperative.

As a result, you will not be able to see information about your driving conditions, such as

- speed
- outside temperature
- warning/indicator lamps

- malfunction/warning messages
- failure of any systems

Driving characteristics may be impaired.

If you must continue to drive, do so with added caution. Contact an authorized Mercedes-Benz Center as soon as possible.

WARNING

Malfunction and warning messages are only indicated for certain systems and are intentionally not very detailed. The malfunction and warning messages are simply a reminder with respect to the operation of certain systems. They do not replace the owner's and/or driver's responsibility to maintain the vehicle's operating safety. Have all required maintenance and safety checks performed on the vehicle. Bring the vehicle to an authorized Mercedes-Benz Center to address the malfunction and warning messages.

Displays and operation

Engine oil temperature display

The engine oil temperature gauge is in the instrument cluster on the right-hand side. Under normal operating conditions, the temperature may rise to 140 °C.

The transmission fluid temperature and the coolant temperature are displayed in the AMG menu (▷ page 160).

Tachometer

The red band in the tachometer indicates the engine's overrevving range.

! Do not drive in the overrevving range, as this could damage the engine.

The fuel supply is interrupted to protect the engine when the red band is reached.

Outside temperature display

⚠ WARNING

The outside temperature indicator is not designed to serve as an ice-warning device and is therefore unsuitable for that purpose. Indicated temperatures just above the freezing point do not guarantee that the road surface is free of ice. The road may still be icy, especially in wooded areas or on bridges.

The outside temperature display is in the multifunction display (▷ page 149). Changes in the outside temperature are displayed after a short delay.

Operating the on-board computer

The on-board computer is activated as soon as you turn the SmartKey to position **1** in the ignition lock.

You can control the multifunction display and the settings in the on-board computer using the buttons on the multifunction steering wheel.

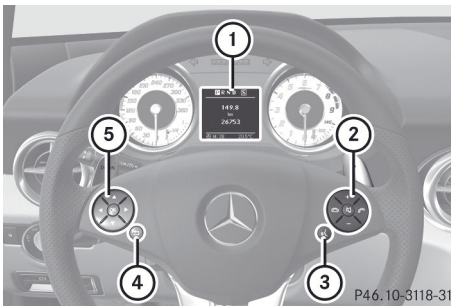

- ① Multifunction display
- ② Makes/accepts or rejects/ends a call
 Increases/reduces volume
- ③ Switches on the Voice Control System; see the separate operating instructions

- ④ **Press briefly:** back, deactivates the Voice Control System and fades out display messages
Press and hold: selects the standard display

- ⑤ Selects the menu bar and selects menus

- Press briefly:** selects a submenu or scrolls through lists
 In the **Audio** menu, selects a stored station, an audio track or a video scene
 In the **Te1** menu (telephone), switches to the telephone book and selects a name or a telephone number

- Press and hold:** In the **Audio** menu, selects the previous/next station, selects an audio track or a video scene using rapid scroll
 In the **Te1** menu (telephone), starts telephone book rapid scroll

- Confirms selection and hides display messages
 In the **Te1** menu (telephone), switches to the phone book and starts dialing

Multifunction display

Values and settings as well as display messages are shown in the multifunction display.

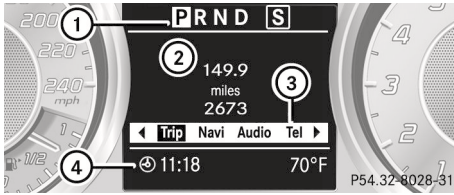

- ① Selector lever position/shift range and drive program
- ② Description field
- ③ Menu bar
- ④ Status line with time and outside temperature

► **To display menu bar ③:** press the ◀ or ▶ button on the steering wheel.

Menus and submenus

Menu overview

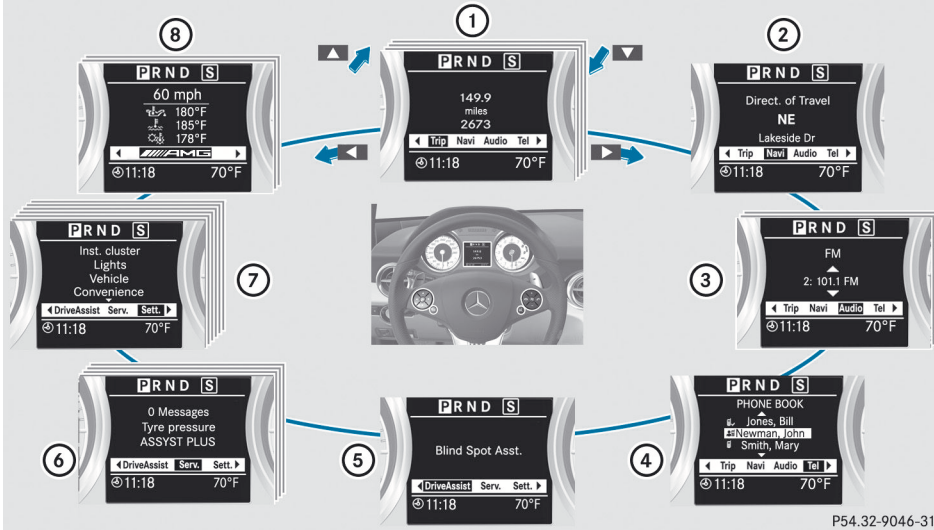

P54.32-9046-31

	Function
①	Trip menu (▷ page 152)
②	Navi menu (navigation instructions) (▷ page 153)
③	Audio menu (▷ page 154)
④	Tel menu (telephone) (▷ page 155)
⑤	Assist. menu (assistance) (▷ page 143)
⑥	Serv. menu (▷ page 157) <ul style="list-style-type: none"> • Calls up display messages (▷ page 164) • Checks the tire pressure electronically (▷ page 257) • ASSYST PLUS service interval display (▷ page 222)
⑦	Settings menu (▷ page 157)
⑧	AMG menu (▷ page 160)

The number of menus shown depends on the optional equipment in the vehicle.

Trip menu

Standard display

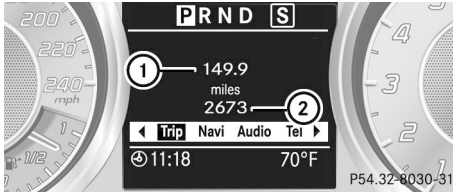

- ▶ Press and hold the button on the steering wheel until the **Trip** menu with trip odometer ① and odometer ② is shown.

Trip computer "From start" or "From reset"

The values in the **From Start** submenu are calculated from the start of a journey whilst the values in the **From Reset** submenu are calculated from the last time the submenu was reset.

- ▶ Press the or button on the steering wheel to select the **Trip** menu.
- ▶ Press the or button to select **From Start** or **From Reset**.

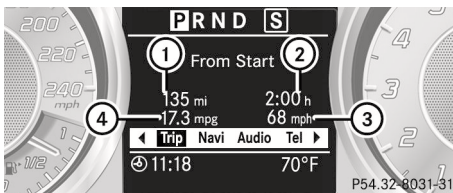

Example: trip computer "From start"

- ① Distance
- ② Time
- ③ Average speed
- ④ Average fuel consumption

The **From Start** trip computer is automatically reset if:

- the ignition has been switched off for more than four hours.
- 999 hours have been exceeded.
- 9,999 miles have been exceeded.

If 9,999 hours or 99,999 kilometers are exceeded, the trip computer **From Reset** is automatically reset.

Calling up the range

- ▶ Press the or button on the steering wheel to select the **Trip** menu.

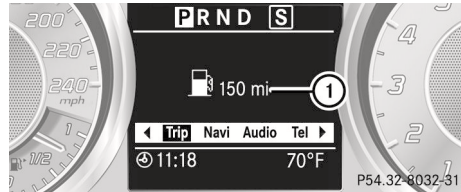

- ▶ Press or to select approximate range ①.

Approximate range ① is calculated according to current driving style and the amount of fuel in the tank. If there is only a small amount of fuel left in the fuel tank, the display shows a vehicle being refueled instead of range ①.

Digital speedometer

- ▶ Press the or button on the steering wheel to select the **Trip** menu.
- ▶ Press the or button to select the digital speedometer.

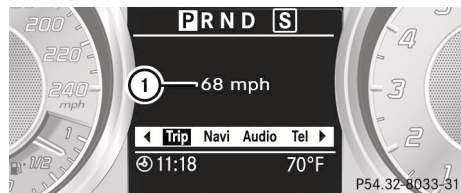

- ① Digital speedometer

Resetting values

You can reset the values of the following functions:

- trip odometer
- trip computer "From start"
- trip computer "From reset"

- ▶ Press the or button to select the **Trip** menu.
- ▶ Press the or button to select the function that you wish to reset.
- ▶ Press .

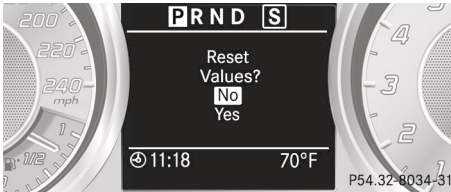

Resetting the trip computer "From start" (example)

- ▶ Press the button to select **Yes** and press the button to confirm.

Navigation system menu

Displaying navigation instructions

In the **Navi** menu, the multifunction display shows navigation instructions. You can find further information in the separate COMAND operating instructions.

- ▶ Press the or button on the steering wheel to select the **Navi** menu.

Route guidance inactive

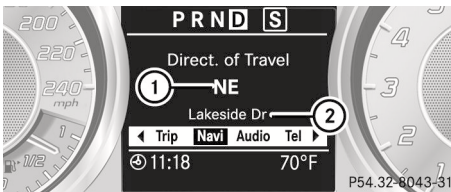

Example: direction of travel display

- ① Direction of travel
- ② Current road

Route guidance active

No change of direction announced

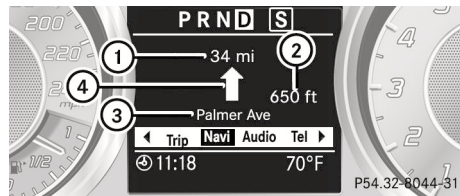

- ① Distance to the destination
- ② Distance to the next change of direction
- ③ Current road
- ④ Symbol for "follow the road's course"

Change of direction announced without a lane recommendation

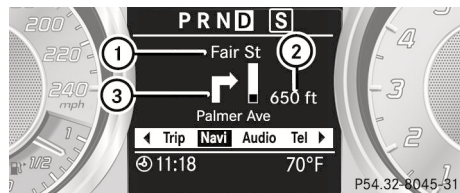

- ① Road into which the change of direction leads
- ② Distance to change of direction and visual distance display
- ③ Symbol for change of direction

When a change of direction has been announced, you will see visual distance display ② next to the symbol for change of direction ③. This decreases in size as you approach the announced change of direction.

Change of direction announced with a lane recommendation

Lane recommendations are only displayed if the relevant data is available on the digital map.

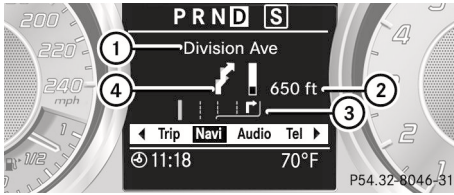

- ① Road into which the change of direction leads
- ② Distance to change of direction and visual distance display
- ③ Lane recommendation
- ④ Symbol for change of direction

On multi-lane roads, lane recommendation ③ may be shown for the next change of direction. Lanes may be added during a change of direction.

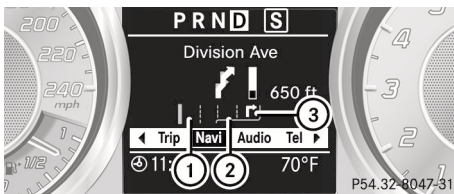

Lane recommendation display (example)

- ① Uninterrupted lane
- ② New lane during a change of direction
- ③ Lane recommended for the change of direction

You can find further information on lane recommendation in the separate COMAND operating instructions.

Other status indicators of the navigation system

- : you have reached the destination.
- **New Route...** or **Calculating Route:** a new route is being calculated.
- **Off Map** or **Off Mapped Road:** the vehicle position is outside the area of the digital map (off-map position).
- **No Route:** no route could be calculated to the selected destination.

You can find further information on status indicators in the separate COMAND operating instructions.

Audio menu

Selecting a radio station

You can only change the waveband and store new stations using COMAND.

- ▶ Press the or button on the steering wheel to select the **Audio** menu.

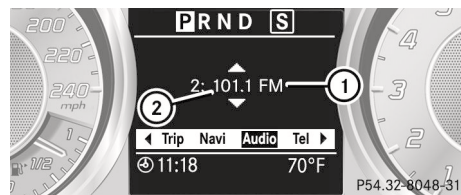

- ① Waveband
- ② Station¹⁰

- ▶ **To select a stored station:** briefly press the or button.
- ▶ **To select a station from the station list:** press and briefly hold the or button.
- ▶ **To select a station using the station search** (only if no station list is received): press and briefly hold the or button.

- **i** SIRIUS XM satellite radio acts like a normal radio.

You can find further information on operating the satellite radio in the separate operating instructions.

Operating audio player or data carrier

Audio data from various audio devices or media can be played, depending on the equipment installed in the vehicle.

- ▶ Press the or button on the steering wheel to select the **Audio** menu.

¹⁰ If the station has been stored, the memory position will also be displayed.

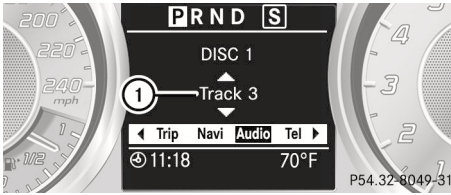

CD player display (example)

① Current track

- ▶ **To select the next/previous track:** briefly press the or button.
- ▶ **To select a track from the track list (rapid scrolling):** press and hold the or button until the desired track has been reached.

If track information is stored on the audio device or medium, the multifunction display will show the number and name of the track. The current track does not appear in audio AUX mode (**A**uxiliary audio mode: external audio source connected).

Video DVD operation

- ▶ Press the or button on the steering wheel to select the **A**udio menu.

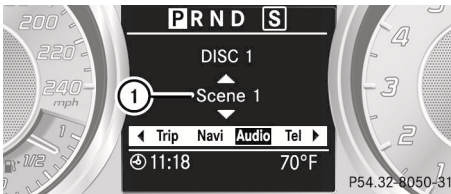

- ▶ **To select the next or previous scene:** briefly press the or button.
- ▶ **To select a scene from the scene list (rapid scrolling):** press and hold the or button until the desired scene has been reached.

Telephone menu

Introduction



WARNING

A driver's attention to the road must always be his/her primary focus when driving. For

your safety and the safety of others, we recommend that you pull over to a safe location and stop before placing or taking a telephone call. If you choose to use the telephone while driving, please use the hands-free device and only use the telephone when weather, road and traffic conditions permit. Some jurisdictions prohibit the driver from using a mobile phone while driving a vehicle. Bear in mind that at a speed of just 30 mph (approximately 50 km/h), your vehicle is covering a distance of 44 feet (approximately 14 m) every second.

Functions and displays are dependent on the optional equipment installed in your vehicle. You can establish a Bluetooth® connection to COMAND (see the separate operating instructions).

- ▶ Switch on the mobile phone and COMAND.
- ▶ Press the or button on the steering wheel to select the **T**el menu.

You will see one of the following display messages in the multifunction display:

- **Please Enter PIN:** the mobile phone has been placed in the mobile phone bracket and the PIN has not been entered.
- ▶ Enter the PIN using the mobile phone, Voice Control System or COMAND. The mobile phone will search for a network. In the meantime, the **Phone No Service** display message appears in the multifunction display.
- **Phone ready** or the name of the network provider: the mobile phone has found a network and is ready to receive.
- **Phone No Service:** there is no network available or the mobile phone is searching for a network.

Accepting a call

If someone calls you when you are in the **T**el menu, a display message appears in the multifunction display, for example:

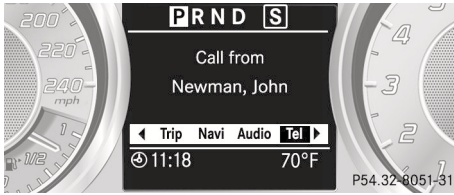

- ▶ Press the button on the steering wheel to accept an incoming call.

You can accept a call even if you are not in the **Tel** menu.

Rejecting or ending a call

- ▶ Press the button on the steering wheel.

You can end or reject a call even if you are not in the **Tel** menu.

Dialing a number from the phone book

If your mobile phone is able to receive calls, you can search for and dial a number from the phone book in COMAND at any time.

- ▶ Copy the phone book from the mobile phone to COMAND.
- ▶ Press the or button on the steering wheel to select the **Tel** menu.
- ▶ Press the , or **OK** button to call up the phone book.
- ▶ Press the or button to select the desired name.

To scroll rapidly, press and hold the or the button for longer than one second. After a short time, the rapid scroll speeds up.

Rapid scrolling stops when you release the button or reach the end of the list.

- ▶ **If only one telephone number is stored for a name:** press the or **OK** button to start dialing.

or

- ▶ **If there is more than one number for a particular name:** press the or **OK** button to display the numbers.
- ▶ Press the or button to select the number you want to dial.
- ▶ Press the or **OK** button to start dialing.

or

- ▶ **If you do not want to make a call:** press the button.

Redialing

The on-board computer saves the last names or numbers dialed in the redial memory.

- ▶ Press the or button on the steering wheel to select the **Tel** menu.
- ▶ Press the button to switch to the redial memory.
- ▶ Press the or button to select the desired name or number.
- ▶ Press the or **OK** button to start dialing.

Assistance menu

Activating/deactivating Blind Spot Assist

You can use the **Blind Spot Asst.** function to activate or deactivate Blind Spot Assist (> page 143).

- ▶ Press the or button on the steering wheel to select the **DriveAssist** menu.
 - ▶ Press **OK**.
- The current selection is displayed.
- ▶ **To activate/deactivate:** press **OK** again.

Service menu

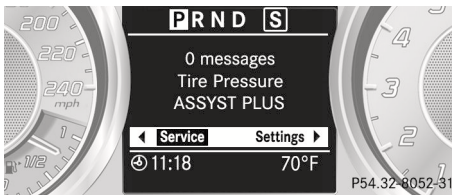

In the **Serv.** menu, you can:

- call up display messages (▷ page 164)
- check the tire pressure electronically (▷ page 257)
- call up the service due date (▷ page 222)

Settings menu

Introduction

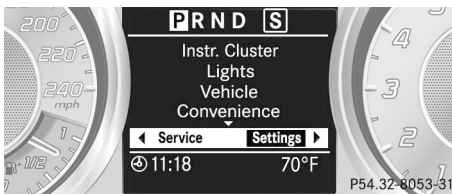

In the **Settings** menu you can:

- change the instrument cluster settings (▷ page 157)
- change the light settings (▷ page 157)
- change the vehicle settings (▷ page 159)
- change the convenience settings (▷ page 159)
- restore the factory settings (▷ page 160)

Instrument cluster

Selecting the unit of measurement for distance

The **Display unit Speed-/odometer:** function allows you to choose whether certain displays appear in km/h or mph in the multifunction display.

The selected units apply to:

- the odometer and the trip odometer
- the trip computer
- the digital speedometer in the **Trip** menu

- the digital speedometer in the **AMG** menu
- the navigation instructions in the **Navi** menu
- cruise control

- ▶ Press the or button on the steering wheel to select the **Settings** menu.
- ▶ Press the or button to select the **INST. CLUSTER** submenu.
- ▶ Press the button to confirm.
- ▶ Press the or button to select the **Display unit Speed-/Odometer:** function.
You will see the selected setting: **km** or **miles**.
- ▶ Press the button to save the setting.

Permanent display for outside temperature or additional speedometer

The **Permanent display: Outside Temperature/Speedometer** allows you to choose whether the multifunction display shows the outside temperature or the speed at the bottom right. The unit used in the additional speedometer depends on the display unit set (▷ page 157).

- ▶ Press the or button on the steering wheel to select the **Settings** menu.
- ▶ Press the or button to select the **INST. CLUSTER** submenu.
- ▶ Press the button to confirm.
- ▶ Press the or button to select the **Permanent display** function.
You will see the selected setting [**km/h**] or **Dig. speedom [mph]** or **outside temperature**.
- ▶ Press the button to save the setting.

Lights

Switching the daytime running lights on/off

This function is not available in Canada.

If you have activated the **Daytime Running Lights** function and the light switch is in the **AUTO** or **A** position, the daytime running lamps are switched on automatically when the engine is running. If it is dark, the low-beam headlamps switch on automatically. In the dark, the following also light up:

- the low-beam headlamps
 - the standing lamps
 - the tail lamps
 - the license plate lamp
 - the side marker lamps
- ▶ Press the **◀** or **▶** button on the steering wheel to select the **Settings** menu.
- ▶ Press the **▼** or **▲** button to select the **LIGHTS** submenu.
- ▶ Press the **OK** button to confirm.
- ▶ Press the **▼** or **▲** button to select the **Daytime Running Lights** function. You will see the selected setting: **Enabled** or **Disabled**.
- ▶ Press the **OK** button to save the setting.

Setting the brightness for the display and switches

You can use the **Brightness display/switches** function to set the brightness of the multifunction display and the switches in the vehicle.

- ▶ Press the **◀** or **▶** button on the steering wheel to select the **Settings** menu.
- ▶ Press the **▼** or **▲** button to select the **Light** submenu.
- ▶ Press the **OK** button to confirm.
- ▶ Press the **▼** or **▲** button to select the **Brightness Display/Switches** function. You see the selected setting **Level** with a value of between 0 and 100.

- ▶ Press the **OK** button to save the setting.
- ▶ Press the **▼** or **▲** button to increase or decrease the brightness.

Activating/deactivating surround lighting and exterior lighting delayed switch-off

The **Locator Lighting** function allows you to set whether the exterior lighting should come on when it is dark:

- for 40 seconds after unlocking the vehicle with the SmartKey
- The exterior lighting switches off if you open the driver's door.
- for 15 seconds after switching off the engine and closing the doors

If the engine is switched off and then none of the doors are opened, or if an open door is not closed, the exterior lighting goes out after 60 seconds.

If you activate the **Locator Lighting** function, the following light up:

- the parking lamps
 - the low-beam headlamps
 - the license plate lamp
 - the surround lighting in the exterior mirrors
- ▶ Press the **◀** or **▶** button on the steering wheel to select the **Settings** menu.
- ▶ Press the **▼** or **▲** button to select the **Light** submenu.
- ▶ Press the **OK** button to confirm.
- ▶ Press the **▼** or **▲** button to select the **Locator Lighting** function. You will see the selected setting: **on** or **off**.
- ▶ Press the **OK** button to save the setting.









Deactivating the delayed switch-off temporarily:

- ▶ Select key position **0** with the Start/Stop button before leaving the vehicle.
- ▶ Select key position **2** and then key position **0** again with the Start/Stop button. The delayed switch-off is deactivated.

Delayed switch-off is reactivated the next time you start the engine.

Activating/deactivating the interior lighting delayed switch-off







If you select key position **0** with the Start/Stop button when the **Light. Delay** function is activated, the interior lighting lights up for approximately 20 seconds if it is dark.



- ▶ Press the  or  button on the steering wheel to select the **Settings** menu.
- ▶ Press the  or  button to select the **Light** submenu.
- ▶ Press the  button to confirm.
- ▶ Press the  or  button to select the **Interior lighting delay sw. off** function. You will see the selected setting: **Enabled** or **Disabled**.
- ▶ Press the  button to save the setting.

Vehicle

Activating/deactivating the automatic door locking mechanism









If you select the **Automatic Door Lock:** function, the vehicle is centrally locked above a speed of around 9 mph (15 km/h).

- ▶  For further information on the automatic locking feature, see (▶ page 71).
- ▶ Press the  or  button on the steering wheel to select the **Settings** menu.
- ▶ Press the  or  button to select the **Vehicle** submenu.
- ▶ Press the  button to confirm.

- ▶ Press the  or  button to select the **Automatic door locks** function. You will see the selected setting: **Enabled** or **Disabled**.
- ▶ Press the  button to save the setting.

Activating/deactivating the acoustic locking verification signal

You can use the **Acoustic Lock** function to determine whether there is an acoustic confirmation when locking and unlocking the vehicle.

- ▶ Press the  or  button on the steering wheel to select the **Settings** menu.
- ▶ Press the  or  button to select the **VEHICLE** submenu.
- ▶ Press the  button to confirm.
- ▶ Press the  or  button to select the **Acoustic Lock** function. You will see the selected setting: **Activated** or **Deactivated**.
- ▶ Press the  button to save the setting.

Convenience

Activating/deactivating the EASY-ENTRY/EXIT feature









WARNING

You must make sure no one can become trapped or injured by the moving steering wheel when the easy-entry/exit feature is activated.

To stop steering wheel movement, move steering wheel adjustment lever or press one of the memory position buttons.

Do not leave children unattended in the vehicle, or with access to an unlocked vehicle. Children could open the driver's door and unintentionally activate the easy-entry/exit feature, which could result in an accident and/or serious personal injury.









You can use the **Easy Entry/Exit:** function to activate or deactivate the EASY-ENTRY/EXIT feature (▶ page 88).

- ▶ Press the  or  button on the steering wheel to select the **Settings** menu.
- ▶ Press the  or  button to select the **Convenience** submenu.
- ▶ Press the  button to confirm.
- ▶ Press the  or  button to select the **Easy Entry/Exit** feature.
You will see the selected setting: **on** or **off**.
- ▶ Press the  button to save the setting.

Switching the fold-in exterior mirrors with locking function on/off









If you switch on the **Fold Mirrors in when Locking**: function, the exterior mirrors fold in when you lock the vehicle. If you unlock the vehicle and then open the driver's or front-passenger door, the exterior mirrors fold out again.

If you have switched the function on and you fold the exterior mirrors in using the button on the door (> page 90), they will not fold out automatically. The exterior mirrors can then only be folded out using the button on the door.

- ▶ Press the  or  button on the steering wheel to select the **Settings** menu.
- ▶ Press the  or  button to select the **CONVENIENCE** submenu.
- ▶ Press the  button to confirm.
- ▶ Press the  or  button to select the **Fold mirrors in when locking**: function.
You will see the selected setting: **on** or **off**.
- ▶ Press the  button to save the setting.



Resetting to factory settings

For safety reasons, the **Daytime Running Lights**: function in the **Lights** submenu is only reset when the vehicle is stationary.

- ▶ Press the  or  button on the steering wheel to select the **Settings** menu.
- ▶ Press the  or  button to select the **Factory Settings** submenu.
- ▶ Press the  button to confirm.
The **Reset All Settings?** message appears.
- ▶ Press the  or  button to select **Yes** or **No**.
- ▶ Press the  button to confirm the selection.
If you have selected **Yes**, the multifunction display shows a confirmation message.

AMG menu

AMG displays

- ▶ Press the  or  button on the steering wheel to select the **AMG** menu.

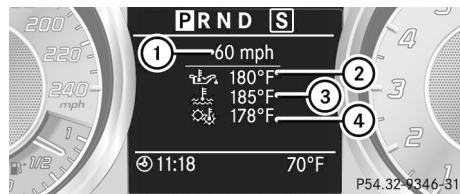

- ① Digital speedometer
- ② Engine oil temperature
- ③ Coolant temperature
- ④ Transmission fluid temperature

If the engine oil temperature is below 80 °C or if the transmission fluid temperature is below 60 °C, the corresponding temperature gauge flashes. Avoid driving at full engine output during this time.

SETUP

SETUP displays the drive program, the AMG adaptive sport suspension system setting and the selected traction assist.

- ▶ Press the or button on the steering wheel to select the **AMG** menu.
 - ▶ Press the button repeatedly until **SETUP** is displayed.
- or
- ▶ Press the **AMG** button on the center console.

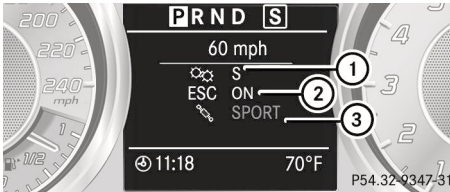

- ① Drive program (**C/S/S+/M**)
- ② ESP® mode (**ON/Sport Handling Mode/OFF**)
- ③ AMG adaptive sport suspension system setting (**COMFORT/SPORT/SPORT +**)

RACETIMER

Displaying and starting RACETIMER

WARNING

The RACETIMER feature is only for use on roads and in conditions where high speed driving is permitted. Racing on public roads is prohibited under all circumstances. The driver is and must always remain responsible for following posted speed limits.

You can use the RACETIMER to store lap times.

- ▶ Press the or button on the steering wheel to select the **AMG** menu.
 - ▶ Press the button repeatedly until the RACETIMER is shown.
- i** If the RACETIMER is selected, the and buttons are inoperative.

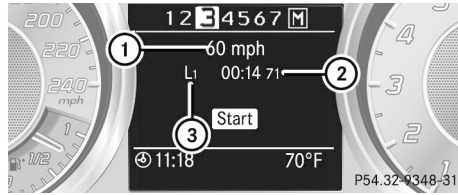

- ① Digital speedometer
- ② RACETIMER
- ③ Lap

You can start the RACETIMER when the engine is running or if key position **2** is selected with the Start/Stop button.

- ▶ **To start:** start the RACETIMER with .

Displaying the intermediate time



- ▶ Press the or button to select **Interm. Time**.
- ▶ Press the button to confirm.
The intermediate time is displayed for five seconds.

Starting a new lap

It is possible to store a maximum of sixteen laps.

- ▶ Press to confirm **New Lap**.

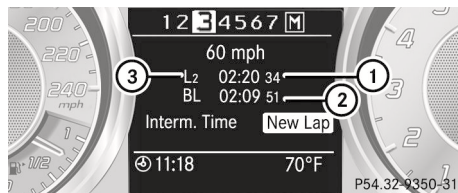

- ① RACETIMER
- ② Fastest lap time (best lap)
- ③ Lap

Stopping the RACETIMER

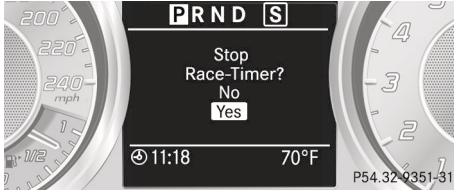

- ▶ Press the  button on the steering wheel.



- ▶ Press the  button to confirm **YES**.

If you stop the vehicle and select key position **1** with the Start/Stop button, the RACETIMER interrupts timing. If you select key position **2** or **3** with the Start/Stop button and then press  to select **START**, timing is continued.

Resetting the current lap

- ▶ Stop the RACETIMER.
- ▶ Press  or  to select **Reset Lap**.
- ▶ Press  to reset the lap time to "0".



Deleting all laps

If you switch off the engine, the RACETIMER is reset to "0" after 30 seconds. All laps are deleted.

You cannot delete individual stored laps. If you have stopped 16 laps, the current lap does not have to be reset.

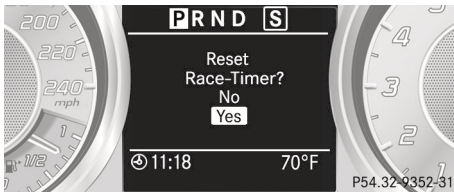

- ▶ Reset the current lap.
- ▶ Press  to confirm **Reset**. **Reset Race Timer** appears in the multifunction display.



- ▶ Press the  button to select **YES** and press the  button to confirm. All laps are deleted.

Overall statistics

This function is shown if you have stored at least one lap and stopped the RACETIMER.

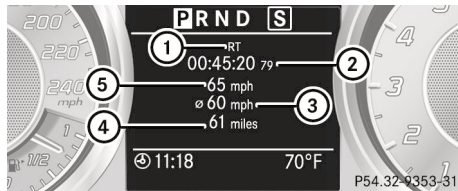

- ▶ Press the  or  button on the steering wheel to select the **AMG** menu.
- ▶ Press the  button repeatedly until the overall evaluation is shown.



- ① RACETIMER overall evaluation
- ② Total time driven
- ③ Average speed
- ④ Distance covered
- ⑤ Top speed



Lap statistics

This function is only available if you have stored at least two laps and have stopped the RACETIMER.

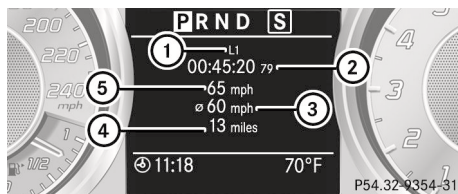
- ▶ Press the  or  button on the steering wheel to select the **AMG** menu.
- ▶ Press the  button repeatedly until the lap evaluation is shown. Each lap is shown in a separate submenu. The fastest lap is indicated by flashing symbol ①.



- ① Lap
- ② Lap time
- ③ Average lap speed
- ④ Lap length
- ⑤ Top speed during lap

- ▶ Press the  or  button to select a different lap evaluation.

Display messages



Hiding display messages

WARNING

All categories of messages contain important information which should be taken note of and, where a malfunction is indicated, addressed as soon as possible at an authorized Mercedes-Benz Center.

Failure to repair the condition noted may cause damage not covered by the Mercedes-Benz Limited Warranty, or result in property damage or personal injury.

Display messages appear in the multifunction display.

- ▶ Press the  or  button on the steering wheel to hide the display message. The display message is cleared.







The multifunction display shows high-priority display messages in red.

You cannot hide display messages of the highest priority. The multifunction display shows these messages continuously until the causes for the messages have been remedied.

Certain display messages are accompanied by an audible warning tone or a continuous tone. Please respond in accordance with the display messages and follow the additional notes in this Operator's Manual.





















Message memory





The on-board computer saves certain display messages. You can call up the display messages in the **message memory**.



- ▶ Press  or  on the steering wheel to select the **Serv.** menu. If there are display messages, the multifunction display shows **2 Messages**, for example.
- ▶ Press the  or  button to select the entry, e.g. **2 Messages**.
- ▶ Confirm with .
- ▶ Press the  or  button to scroll through the display messages.







When the ignition is switched off, all display messages are deleted apart from some high-priority display messages. Once the causes of the high-priority display messages have been rectified, the corresponding display messages are also deleted.





Brakes

Display messages	Possible causes/consequences and ► Solutions
<p> (USA only)</p> <p> (Canada only)</p> <p>ABS and ESC Currently Unavailable See Operator's Manual</p>	<p> Risk of accident</p> <p>ABS (Anti-lock Braking System), ESP® (Electronic Stability Program), BAS (Brake Assist) and hill start assist are temporarily unavailable. For example, the on-board voltage may be insufficient. In addition, the ,  and  warning lamps light up in the instrument cluster.</p> <p>The brake system continues to function normally, but without the functions listed above. The wheels could therefore lock if you brake hard, for example.</p> <ul style="list-style-type: none"> ► Drive on carefully. ► Visit a qualified specialist workshop.
<p> (USA only)</p> <p> (Canada only)</p> <p>ABS and ESC Inoperative See Operator's Manual</p>	<p> Risk of accident</p> <p>ABS, ESP®, BAS and hill start assist are unavailable due to a malfunction. In addition, the ,  and  warning lamps light up in the instrument cluster.</p> <p>The brake system continues to function normally, but without the functions listed above.</p> <ul style="list-style-type: none"> ► Drive on carefully. ► Visit a qualified specialist workshop.
<p> (USA only)</p> <p> (Canada only)</p> <p>EBD, ABS, and ESC Inoperative See Operator's Manual</p>	<p> Risk of accident</p> <p>EBD (electronic brake force distribution), ABS, ESP®, BAS and hill start assist are unavailable due to a malfunction. In addition, the ,  and  warning lamps light up in the instrument cluster and a warning tone sounds.</p> <p>The brake system continues to function normally, but without the functions listed above.</p> <ul style="list-style-type: none"> ► Drive on carefully. ► Visit a qualified specialist workshop immediately.
<p> (USA only)</p> <p> (Canada only)</p> <p>Please Release Parking Brake</p>	<p> The indicator lamp (red) flashes and a warning tone sounds. You are driving with the electric parking brake applied.</p> <ul style="list-style-type: none"> ► Release the electric parking brake. <p>or</p> <ul style="list-style-type: none"> ► Consult a qualified specialist workshop.

Display messages	Possible causes/consequences and ► Solutions
	<p> The indicator lamp (red) flashes, the warning lamp (yellow) lights up and a warning tone sounds. The electric parking brake is malfunctioning and the braking effect is restricted.</p> <p>While the vehicle is in motion:</p> <ul style="list-style-type: none"> ► Release the electric parking brake handle. <p>While the vehicle is stationary:</p> <ul style="list-style-type: none"> ► Switch off the ignition and turn it back on. ► Release the electric parking brake. <p>If the display message continues to be displayed:</p> <ul style="list-style-type: none"> ► Shift the transmission to P using the button on the center console. ► Prevent the vehicle from rolling away before you leave it. ► Consult a qualified specialist workshop. <hr/> <p> The indicator lamp (red) flashes and a warning tone sounds. You are making an emergency stop using the electric parking brake.</p> <ul style="list-style-type: none"> ► After the emergency stop: release the electric parking brake lever.
<p> (USA only)</p> <p> (Canada only)</p> <p>Parking Brake See Oper. Manual</p>	<p> The warning lamp (yellow) lights up. Additionally the indicator lamp (red) lights up. The electric parking brake is malfunctioning.</p> <p>To release:</p> <ul style="list-style-type: none"> ► Pull the electric parking brake handle. <p>or</p> <ul style="list-style-type: none"> ► Pull away carefully. ► Visit a qualified specialist workshop. <p>To apply:</p> <ul style="list-style-type: none"> ► Switch off the ignition. ► Pull the electric parking brake lever for at least ten seconds, until the display message disappears. <p>If the display message continues to be displayed:</p> <ul style="list-style-type: none"> ► Shift the transmission to P using the button on the center console. ► Prevent the vehicle from rolling away before you leave it. ► Consult a qualified specialist workshop.

Display messages	Possible causes/consequences and ► Solutions
	<p> The indicator lamp (red) flashes. The power supply for the electric parking brake was interrupted.</p> <ul style="list-style-type: none"> ► Pull the electric parking brake handle. <p>or</p> <ul style="list-style-type: none"> ► Pull away carefully. <p>or</p> <ul style="list-style-type: none"> ► Pull the electric parking brake handle until the display message disappears.
	<p> The indicator lamp (red) flashes and the warning lamp (yellow) lights up. The electric parking brake is malfunctioning.</p> <ul style="list-style-type: none"> ► Switch off the ignition and turn it back on. ► Engage or release the electric parking brake. <p>or</p> <ul style="list-style-type: none"> ► Pull away carefully. ► Visit a qualified specialist workshop.
	<p> The warning lamp (yellow) lights up. In addition, the indicator lamp (red) flashes for about 10 seconds after the electric parking brake has been engaged or released. It then goes out or remains lit. The electric parking brake is malfunctioning, e.g. because of overvoltage or undervoltage.</p> <ul style="list-style-type: none"> ► Pull away carefully. ► Visit a qualified specialist workshop. <p>If there is overvoltage or undervoltage:</p> <ul style="list-style-type: none"> ► Remove the cause for the overvoltage or undervoltage, e.g. by charging the battery or restarting the engine. ► Switch the ignition off and on, and then engage or release the electric parking brake. <p>If this does not release the electric parking brake:</p> <ul style="list-style-type: none"> ► Do not drive on. ► Consult a qualified specialist workshop.

Display messages	Possible causes/consequences and ► Solutions
	<p> The warning lamp (yellow) lights up. In addition, the indicator lamp (red) flashes for about 10 seconds after the electric parking brake has been engaged or released. It then goes out or remains lit.</p> <p>The electric parking brake has overheated.</p> <ul style="list-style-type: none"> ► Allow the vehicle to cool down. Do not engage or release the electric parking brake during this time. ► Prevent the vehicle from rolling away before you leave it. ► When the vehicle has cooled down: switch the ignition off and on again, then engage or release the electric parking brake.
<p> (USA only)</p> <p> (Canada only)</p> <p>Parking Brake Inoperative</p>	<p> The warning lamp (yellow) lights up. In addition, the indicator lamp (red) flashes for about 10 seconds after the electric parking brake has been engaged or released. It then goes out or remains lit.</p> <p>The electric parking brake is malfunctioning.</p> <ul style="list-style-type: none"> ► Switch the ignition off and on, and then engage the electric parking brake. <p>If it is not possible to engage the electric parking brake:</p> <ul style="list-style-type: none"> ► Shift the transmission to P using the button on the center console. ► Prevent the vehicle from rolling away before you leave it. ► Visit a qualified specialist workshop.
<p> (USA only)</p> <p> (Canada only)</p> <p>Turn On the Ignition to Release the Parking Brake</p>	<p> The indicator lamp (red) flashes.</p> <p>You attempted to release the electric parking brake while the ignition was switched off.</p> <ul style="list-style-type: none"> ► Switch on the ignition.









Display messages	Possible causes/consequences and ► Solutions
<p> (USA only)</p> <p> (Canada only)</p> <p>Check Brake Fluid Level</p>	<p> Risk of accident</p> <p>There is not enough brake fluid in the brake fluid reservoir. In addition, the  indicator lamp in the instrument cluster lights up and a warning tone sounds.</p> <ul style="list-style-type: none"> ► Pull over and stop the vehicle safely as soon as possible, paying attention to road and traffic conditions. Do not continue driving under any circumstances. ► Consult a qualified specialist workshop. <p>Do not add brake fluid. This will not rectify the malfunction.</p>
<p></p> <p>Check Brake Pad Wear</p>	<p>The brake pads/linings have reached their wear limit.</p> <ul style="list-style-type: none"> ► Visit a qualified specialist workshop.







 **WARNING**

Driving with the message **Check Brake Fluid Level** displayed can result in an accident. Have your brake system checked immediately.



Do not add brake fluid before checking the brake system. Overfilling the brake fluid reservoir can result in spilling brake fluid on hot engine parts and the brake fluid catching fire. You can be seriously burned.

Safety systems

Display messages	Possible causes/consequences and ► Solutions
 <p>ESP Inoperative See Operator's Manual</p>	<p> Risk of accident</p> <p>ESP®, BAS and hill start assist are unavailable due to a malfunction. In addition, the  and  warning lamps light up in the instrument cluster.</p> <p>The brake system continues to function normally, but without the functions listed above.</p> <ul style="list-style-type: none"> ► Drive on carefully. ► Visit a qualified specialist workshop.
 <p>ESC Currently Unavailable See Operator's Manual</p>	<p> Risk of accident</p> <p>ESP®, BAS and hill start assist are temporarily unavailable. The self-diagnosis function might not be complete, for example. The brake system continues to function normally, but without the functions listed above. In addition, the  and  warning lamps light up in the instrument cluster.</p> <ul style="list-style-type: none"> ► Carefully drive a short distance making slight steering movements at a speed above 12 mph (20 km/h) until the display message disappears.
<p>Front Passenger Airbag Enabled See Operator's Manual</p>	<p>The front-passenger air bag and front-passenger knee bag are enabled during the journey, even though:</p> <ul style="list-style-type: none"> • a child, a small adult or an object weighing less than the system's weight threshold is located on the front-passenger seat. • the front-passenger seat is unoccupied. <p>The system may detect objects or forces applying additional weight on the seat.</p> <ul style="list-style-type: none"> ► Pull over and stop the vehicle safely as soon as possible, paying attention to road and traffic conditions. ► Apply the parking brake. ► Switch the ignition off. ► Open the front-passenger door. ► Remove the child and the child restraint system from the front-passenger seat.

Display messages	Possible causes/consequences and ► Solutions
	<p>► Make sure that there are no objects on the seat adding to the weight. The system may otherwise detect the additional weight and interpret the seat occupant's weight as greater than it actually is.</p> <p>► Keep the seat unoccupied, close the front-passenger door and switch on the ignition.</p> <p>Observe the   (► page 42) indicator lamp and the multifunction display and check the following: Seat unoccupied and ignition switched on:</p> <ul style="list-style-type: none"> • the   indicator lamp must light up and remain lit. When the indicator lamp is on, OCS (► page 42) has disabled the front-passenger air bag. • the Front Passenger Airbag Enabled See Operator's Manual or Front Passenger Airbag Disabled See Operator's Manual display messages must not be shown in the multifunction display. Wait for a period of at least 60 seconds until the necessary system checks have been completed and to make sure that the display messages do not appear in the multifunction display. <p>If these conditions are fulfilled, the front-passenger seat can be occupied again. Whether the   indicator lamp remains lit or goes out depends on how OCS classifies the occupant.</p> <p>If the conditions are not fulfilled, the system is not operating correctly.</p> <p>► Visit a qualified specialist workshop immediately.</p>

 **WARNING**

If the   indicator lamp remains off even after performing the above corrective steps, do not have any children twelve years old and under and other small individuals use the front-passenger seat until the system has been repaired.



Display messages

Front Passenger
Airbag Disabled
See Operator's
Manual



Possible causes/consequences and ► Solutions



The front-passenger air bag and the front-passenger knee bag are deactivated during the journey even though an adult or a person larger than a certain size is occupying the front-passenger seat. If additional forces are applied to the seat, the system may interpret the occupant's weight as lower than it actually is.

- Pull over and stop the vehicle safely as soon as possible, paying attention to road and traffic conditions.
- Apply the parking brake.
- Switch the ignition off.
- Have the occupant get out of the vehicle.
- Keep the seat unoccupied, close the front-passenger door and switch on the ignition.

Observe the   (> page 42) indicator lamp and the multifunction display and check the following:

Seat unoccupied and ignition switched on:



- the   indicator lamp must light up and remain lit. When the indicator lamp is on, OCS (> page 42) has disabled the front-passenger air bag.
- the [Front Passenger Airbag Enabled See Operator's Manual](#) or [Front Passenger Airbag Disabled See Operator's Manual](#) display messages must not be shown in the multifunction display. Wait for at least 60 seconds until the necessary system checks have been completed and to make sure that the display messages do not appear in the multifunction display.







If these conditions are fulfilled, the front-passenger seat can be occupied again. Whether the   indicator lamp remains lit or goes out depends on how OCS classifies the occupant.

If the conditions are not fulfilled, the system is not operating correctly.

- Visit a qualified specialist workshop immediately.

⚠ WARNING

If the   indicator lamp remains lit with an adult occupant on the front-passenger seat even after performing the above corrective steps, do not have any passenger use the front-passenger seat until the system has been repaired.

Display messages	Possible causes/consequences and ► Solutions
 Tele Aid Inoperative	One or more main features of the mbrace system are malfunctioning. ► Have the mbrace system checked immediately at a qualified specialist workshop.
 SRS Malfunction Service Required	<p> Risk of injury</p> There is a malfunction in the SRS (Supplemental Restraint System). The  warning lamp also lights up in the instrument cluster. ► Visit a qualified specialist workshop.
 Front Left SRS Malfunction Service Required or Front Right SRS Malfunction Service Required	<p> Risk of injury</p> SRS has malfunctioned at the front on the left or right. The  warning lamp also lights up in the instrument cluster. ► Visit a qualified specialist workshop.







 **WARNING**

In the event a malfunction of the SRS is indicated as outlined above, the SRS may not be operational.





For your safety, we strongly recommend that you contact an authorized Mercedes-Benz Center immediately to have the system checked. Otherwise the SRS may not be activated when needed in an accident, which could result in serious or fatal injury, or it might deploy unexpectedly and unnecessarily which could also result in injury.

Lights

-  Display messages about LEDs:
 The display message will only appear if all or a number of LEDs have failed.

Display messages	Possible causes/consequences and ► Solutions
 Check Left Low Beam or Check Right Low Beam	The left or right-hand low-beam headlamp does not light up. In addition, the low-beam headlamp is also inoperative. ► Visit a qualified specialist workshop.
 Auto Lamp Function Inoperative	The light sensor is defective. USA only: ► Switch off the daytime running lamps in the on-board computer (> page 157). ► Switch the lights on and off using the light switch.
 Check Rear Left Turn Signal or Check Rear Right Turn Signal	The LEDs in the rear left or right-hand indicator lamp do not light up. ► Visit a qualified specialist workshop.
 Check Left Mirror Turn Signal or Check Right Mirror Turn Signal	None of the LEDs in the left or right-hand exterior mirrors light up. ► Visit a qualified specialist workshop.
 Check Front Left Turn Signal or Check Front Right Turn Signal	The LEDs in the front left or right-hand indicator lamp do not light up. ► Visit a qualified specialist workshop.
 Check Center Brake Lamp	None of the LEDs in the high-mounted brake lamp light up. ► Visit a qualified specialist workshop.

Display messages	Possible causes/consequences and ► Solutions
 Check Left Brake Lamp or Check Right Brake Lamp	The left or right-hand brake light LEDs do not light up. ► Visit a qualified specialist workshop.
 Check Left Tail Lamp or Check Right Tail Lamp	The left or right-hand tail lamp LEDs do not light up. ► Visit a qualified specialist workshop.
 Check Left High Beam or Check Right High Beam	The left or right-hand high-beam headlamp does not light up. ► Visit a qualified specialist workshop.
 Check Left License Plate Lamp or Check Right License Plate Lamp	The left or right-hand license plate lamp does not light up. ► Replace the bulb (► page 99).
 Backup light	None of the LEDs in the backup lamp light up. ► Visit a qualified specialist workshop.
 Left daytime running lamp or Right daytime running lamp	The LEDs in the left or right-hand daytime running lamp do not light up. As a result, the corresponding side/standing lamp has failed. ► Visit a qualified specialist workshop.

Display messages	Possible causes/consequences and ► Solutions
 <p>Check Front Left Sidemarkers Lamp or Check Front Right Sidemarkers Lamp</p>	<p>The left or right front side marker lamp is defective.</p> <p>► Visit a qualified specialist workshop.</p>
 <p>Check Rear Left Sidemarkers Lamp or Check Rear Right Sidemarkers Lamp</p>	<p>The rear left or right side marker lamp is defective.</p> <p>► Visit a qualified specialist workshop.</p>
 <p>Check Front Left Parking Lamp or Check Front Right Parking Lamp</p>	<p>The front left or front right parking or standing lamp is defective.</p> <p>► Visit a qualified specialist workshop.</p>
 <p>Switch off lights</p>	<p>The lights are still switched on when you leave the vehicle. A warning tone also sounds.</p> <p>► Turn the light switch to .</p>
 <p>Malfunction See Operator's Manual</p>	<p>The exterior lighting is defective.</p> <p>► Visit a qualified specialist workshop.</p>

Engine

WARNING



Driving when your engine is overheated can cause some fluids which may have leaked into the engine compartment to catch fire. You could be seriously burned.



Steam from an overheated engine can cause serious burns which can occur just by opening the engine hood. Stay away from the engine if you see or hear steam coming from it.







Stop the vehicle in a safe location away from other traffic. Turn off the engine, get out of the vehicle and do not stand near the vehicle until the engine has cooled down.



WARNING

Do not spill antifreeze on hot engine parts. Antifreeze contains ethylene glycol which may burn if it comes into contact with hot engine parts. You could be seriously burned.

Display messages	Possible causes/consequences and ► Solutions
 <p>Coolant Low Stop Vehicle Turn Engine Off</p>	<p>The coolant is too hot. In addition, the  warning lamp in the instrument cluster lights up and a warning tone sounds.</p> <ul style="list-style-type: none"> ► Pull over and stop the vehicle safely and switch off the engine, paying attention to road and traffic conditions. ► Make sure that the air supply to the radiator is not blocked, e.g. by snow, slush or ice. ► Wait until the display message disappears before restarting the engine. Otherwise, the engine could be damaged. ► Pay attention to the coolant temperature display. ► If the coolant temperature increases again, visit a qualified specialist workshop immediately. <p>! If the coolant temperature is over 248 °F (120 °C), do not continue driving. The engine will otherwise be damaged.</p> <p>The poly-V-belt may have torn. A warning tone also sounds.</p> <ul style="list-style-type: none"> ► Pull over and stop the vehicle safely and switch off the engine, paying attention to road and traffic conditions. ► Check the poly-V-belt. ► If the poly-V-belt is not damaged: do not start the engine again until the display message disappears. Otherwise, the engine could be damaged. ► If the poly-V-belt is torn: do not continue driving. Consult a qualified specialist workshop.
	<p>The engine fan is defective.</p> <ul style="list-style-type: none"> ► At coolant temperatures under 248 °F (120 °C), drive to the next qualified specialist workshop. ► Avoid subjecting the engine to heavy loads (e.g. driving in mountainous terrain) and stop-and-go driving.



Display messages	Possible causes/consequences and ► Solutions
	<p>The battery is not being charged. A warning tone also sounds. Possible causes are:</p> <ul style="list-style-type: none"> • a defective alternator • a torn poly-V-belt • a malfunction in the electronics <p>► Pull over and stop the vehicle safely and switch off the engine, paying attention to road and traffic conditions.</p> <p>► Open the hood.</p> <p>► Check whether the poly-V-belt is torn.</p> <p>If the poly-V-belt is torn:</p> <p>! Do not continue driving. The engine could otherwise overheat.</p> <p>► Consult a qualified specialist workshop.</p> <p>If the poly-V-belt is not damaged:</p> <p>► Visit a qualified specialist workshop.</p>
 <p>Check Coolant Level See Operator's Manual</p>	<p>The coolant level is too low.</p> <p>► add coolant, observing the warning notes before doing so (► page 220).</p> <p>► If coolant needs to be added more often than usual, have the engine coolant system checked at a qualified specialist workshop.</p> <p>! The coolant level is too low. Avoid making long journeys with too little coolant in the cooling system. The engine will otherwise be damaged.</p> <p>The display messages and the corresponding symbol that indicate that the coolant level is too low must not be ignored.</p>
 <p>Engine Oil Level low Stop Vehicle Turn Engine Off</p>	<p>There is insufficient oil in the engine. There is a risk of engine damage.</p> <p>► Pull over and stop the vehicle safely and switch off the engine, paying attention to road and traffic conditions.</p> <p>► Top up and check the engine oil level (► page 219).</p>

Display messages	Possible causes/consequences and ► Solutions
 <p>Check Engine Oil Level (Add 1 Liter)</p>	<p>The oil level is too low.</p> <ul style="list-style-type: none"> ▶ Check the oil level (▷ page 219). ▶ If necessary, add engine oil. ▶ Have the engine checked for leaks if you need to add engine oil more often than usual. <p>Information on approved engine oils can be obtained from any qualified specialist workshop or on the Internet at http://www.mbusa.com (USA only).</p> <p>! The oil level is too low. Avoid long journeys with too little engine oil. There is a risk of engine damage.</p> <p>The display messages and the corresponding symbol that indicate that the oil level is too low must not be ignored.</p>
 <p>Engine Oil Level Too High</p>	<p>You have added too much engine oil. The engine or catalytic converter may be damaged.</p> <ul style="list-style-type: none"> ▶ Siphon off excess engine oil until it is at the specified level. Observe the legal requirements.
 <p>Engine Oil Level Cannot Be Measured</p>	<p>The measuring system is faulty.</p> <ul style="list-style-type: none"> ▶ Visit a qualified specialist workshop.
 <p>Engine Oil Pressure Control See Operator's Manual</p>	<p>The oil pressure sensor has reported a malfunction. The oil pressure control is running in emergency mode. Engine lubrication is guaranteed.</p> <ul style="list-style-type: none"> ▶ Visit a qualified specialist workshop.
 <p>Engine Oil Pressure Stop Vehicle Turn Engine Off</p>	<ul style="list-style-type: none"> ▶ Pull over and stop the vehicle safely and switch off the engine, paying attention to road and traffic conditions. ▶ Check the engine oil level (▷ page 219) and top up if necessary. ▶ If there are visible signs of oil loss from the vehicle, consult a qualified specialist workshop.
	<p>There is only a small amount of fuel in the fuel tank.</p> <ul style="list-style-type: none"> ▶ Refuel at the nearest gas station.
 <p>Fuel Level Low</p>	<p>The fuel level has fallen below the reserve range.</p> <ul style="list-style-type: none"> ▶ Refuel at the nearest gas station.

Display messages	Possible causes/consequences and ► Solutions
 Gas Cap Loose	<p>The fuel system pressure is too low. The fuel filler cap is not closed correctly or the fuel system is leaking.</p> <ul style="list-style-type: none"> ► Check that the fuel filler cap is correctly closed. <p>If the fuel filler cap is not correctly closed:</p> <ul style="list-style-type: none"> ► Close the fuel filler cap. <p>If the fuel filler cap is correctly closed:</p> <ul style="list-style-type: none"> ► Visit a qualified specialist workshop.
 Replace Air Filter	<p>The engine air filter is dirty and must be replaced.</p> <ul style="list-style-type: none"> ► Visit a qualified specialist workshop.
 Check Fuel Filter	<p>Vehicles with a diesel engine: there is water in the fuel filter. The water must be drained off.</p> <ul style="list-style-type: none"> ► Visit a qualified specialist workshop.

Driving systems

Display messages	Possible causes/consequences and ► Solutions
Cruise Control Inoperative	<p>Cruise control is defective.</p> <p>A warning tone also sounds.</p> <ul style="list-style-type: none"> ► Visit a qualified specialist workshop.
Cruise Control --- mph	<p>A condition for activating cruise control has not been fulfilled. You attempted to save a speed of less than 20 mph (30 km/h).</p> <ul style="list-style-type: none"> ► Activate ESP® (> page 57). ► If the situation allows, drive faster than 20 mph (30 km/h) and save the speed. ► Check the activation conditions for cruise control (> page 136).

Display messages	Possible causes/consequences and ► Solutions
Blind Spot Assist Inoperative	<p>Blind Spot Assist is defective.</p> <p>The yellow  indicator lamps also light up in the exterior mirrors.</p> <p>► Visit a qualified specialist workshop.</p>
Blind Spot Assist Currently Unavailable See Operator's Manual	<p>Blind Spot Assist is temporarily inoperative if:</p> <ul style="list-style-type: none"> • the sensors are dirty. • its function is impaired due to heavy rain or snow. • the radar sensor system is outside the operating temperature range. • the radar sensor system is temporarily inoperative, e.g. due to electromagnetic radiation emitted by nearby TV or radio stations or other sources of electromagnetic radiation. <p>The yellow  indicator lamps also light up in the exterior mirrors.</p> <p>Blind Spot Assist is operational again and the display message disappears if:</p> <ul style="list-style-type: none"> • the dirt (e.g. slush) drops away while the vehicle is in motion. • the system detects that the sensors are fully available again. • the radar sensor system is back within the operating temperature range. <p>If the display message continues to be displayed:</p> <p>► Clean the sensors (► page 228).</p> <p>► Restart the engine.</p>

Tires

WARNING



Do not drive with a flat tire. A flat tire affects the ability to steer or brake the vehicle. You may lose control of the vehicle. Continued driving with a flat tire will cause excessive heat build-up and possibly a fire.





WARNING

Follow recommended tire inflation pressures.





Do not underinflate tires. Underinflated tires wear excessively and/or unevenly, adversely affect handling and fuel economy, and are more likely to fail from being overheated.

Do not overinflate tires. Overinflated tires can adversely affect handling and ride comfort, wear unevenly, increase stopping distance, and result in sudden deflation (blowout) because they are more likely to become punctured or damaged by road debris, potholes etc.







Display messages	Possible causes/consequences and ► Solutions
Tire Press. Monitor Inoperative	The tire pressure monitor is faulty. ► Visit a qualified specialist workshop.
Tire Pressure Monitor Inoperative No Wheel Sensors	The wheels mounted do not have a suitable tire pressure sensor. The tire pressure monitor is deactivated. ► Mount wheels with suitable tire pressure sensors. The tire pressure monitor is activated automatically after driving for a few minutes.
Check Tires	 Risk of accident The tire pressure in one or more tires has dropped significantly. The wheel position is displayed in the multifunction display. A warning tone also sounds. ► Stop the vehicle without making any sudden steering or braking maneuvers. Pay attention to the traffic conditions as you do so. ► Correct the tire pressure (► page 257). ► If necessary, change a wheel (► page 271).
Tire Press. Warning Caution Tire Malfunction	 Risk of accident The tire pressure in one or more tires has dropped suddenly. The wheel position is displayed in the multifunction display. A warning tone also sounds. ► Stop the vehicle without making any sudden steering or braking maneuvers. Pay attention to the traffic conditions as you do so. ► If necessary, change a wheel (► page 271).
Correct Tire Pressure	The tire pressure is too low in at least one of the tires or the tire pressure difference between the wheels is too great. ► Check the tire pressures at the next opportunity. If necessary, correct the tire pressure (► page 257).
TirePress. Sensor(s)Missing	There is no signal from the tire pressure sensor of one or several wheels. The pressure of the affected tire is not displayed in the multifunction display. ► Have the faulty tire pressure sensor replaced at a qualified specialist workshop.
Tire Press. Monitor Currently Unavailable	Due to a source of radio interference, no signals can be received from the wheel sensors. The tire pressure monitor is temporarily malfunctioning. ► Drive on. The tire pressure monitor restarts automatically as soon as the problem has been solved.

Display messages	Possible causes/consequences and ► Solutions
 Tire Pressure Warning Caution Tire Malfunction	<p> Risk of accident</p> <p>The tire pressure in one or more tires has dropped suddenly. A warning tone also sounds.</p> <ul style="list-style-type: none"> ► Stop the vehicle without making any sudden steering or braking maneuvers. Pay attention to the traffic conditions as you do so. ► Repair the faulty tire or change the wheel (► page 271).
 Check Tire Pressure	<p> Risk of accident</p> <p>The tire pressure in one or more tires has dropped significantly. A warning tone also sounds.</p> <ul style="list-style-type: none"> ► Stop the vehicle without making any sudden steering or braking maneuvers. Pay attention to the traffic conditions as you do so. ► Correct the tire pressure (► page 257). ► If necessary, repair the faulty tire or change the wheel (► page 271).







Vehicle



Display messages	Possible causes/consequences and ► Solutions
120 km/h Maximum Speed Exceeded	<p>The maximum speed has been exceeded¹¹.</p> <ul style="list-style-type: none"> ► Drive more slowly.
	<p>The trunk lid is open.</p> <ul style="list-style-type: none"> ► Close the trunk lid.
	<p> Risk of accident</p> <p>The hood is open.</p> <ul style="list-style-type: none"> ► Pull over and stop the vehicle safely as soon as possible, paying attention to road and traffic conditions. ► Close the hood.
 (Coupe only)  (Roadster only)	<p>At least one door is open.</p> <ul style="list-style-type: none"> ► Close the doors.

¹¹ Only for certain countries.

Display messages	Possible causes/consequences and ► Solutions
 <p>Convertible Top Operation Possible to 31 mph</p>	<p>If you are traveling at more than 31 mph (50 km/h), you cannot open or close the soft top.</p> <ul style="list-style-type: none"> ► Fully open or close the soft top (▷ page 78).
 <p>Convertible top Opening/Closing Not Finished</p>	<p>The soft top is not fully opened or closed. The hydraulics are depressurized.</p> <ul style="list-style-type: none"> ► Fully open or close the soft top (▷ page 78).
 <p>Open/Close Convertible Top Completely</p>	<p>The roof is not locked. If you are traveling at more than 31 mph (50 km/h), you cannot open or close the soft top.</p> <ul style="list-style-type: none"> ► If you are traveling at more than 31 mph (50 km/h), slow down. ► Push or pull the soft-top switch (▷ page 78) until the soft top is fully open or closed.
 <p>Convertible Top in Operation Please Wait</p>	<p>The on-board voltage is too low.</p> <ul style="list-style-type: none"> ► Start the engine. <p>The soft top has been opened and closed several times in a row. The soft-top drive has been switched off automatically for safety reasons.</p> <p>You can open and close the soft top again after approximately ten minutes.</p> <ul style="list-style-type: none"> ► Switch off the ignition and turn it back on. ► Repeat the opening or closing procedure (▷ page 78).
 <p>Depress brake</p>	<p>You have attempted to close the soft top with the soft top switch while the vehicle was stationary.</p> <ul style="list-style-type: none"> ► Depress the brake pedal. ► Press the soft-top switch until the soft top is completely closed.
 <p>Check Washer Fluid</p>	<p>The washer fluid level in the washer fluid reservoir has dropped below the minimum.</p> <ul style="list-style-type: none"> ► add washer fluid (▷ page 221).

SmartKey



Display messages	Possible causes/consequences and ► Solutions
 Replace Key Battery	The SmartKey batteries are discharged. ► Change the batteries (▷ page 66).
 Key Not Detected (red display message)	The SmartKey is not in the vehicle. A warning tone also sounds. When you switch off the engine, you will be unable to restart it. ► Pull over and stop the vehicle safely as soon as possible, paying attention to road and traffic conditions. ► Locate the SmartKey.
	The SmartKey is not detected while driving because a powerful radio transmitter is causing interference. A warning tone also sounds. ► Pull over and stop the vehicle safely as soon as possible, paying attention to road and traffic conditions. ► Insert the SmartKey into the ignition lock and turn it to the desired position (▷ page 115).
 Key Not Detected (white display message)	You are in the vehicle and the SmartKey currently cannot be detected by the vehicle. ► Change the location of the SmartKey in the vehicle. If the SmartKey still cannot be detected: ► Insert the SmartKey into the ignition lock and turn it to the desired position (▷ page 115).
 Obtain a New Key	The SmartKey needs to be replaced. ► Visit a qualified specialist workshop.
 Key Does Not Belong to Vehicle	You have put the wrong SmartKey in the ignition lock. ► Use the correct SmartKey.
 Close Doors to Lock Vehicle	At least one door is open. A warning tone also sounds. ► Close all doors and lock the vehicle again.

Display messages	Possible causes/consequences and ► Solutions
 Insert Key	The KEYLESS-GO start function is temporarily malfunctioning or is defective. A warning tone also sounds. ► Insert the SmartKey into the ignition lock and turn it to the desired position (▷ page 115).
 Take Your Key From Ignition	The SmartKey is in the ignition lock. ► Remove the SmartKey.



Transmission

Display messages	Possible causes/consequences and ► Solutions
Apply Brake to Shift from 'P'	You have attempted to move the transmission selector lever to position D , R or N without depressing the brake pedal. ► Depress the brake pedal.
Apply Brake and Start Engine to Disengage 'P'	When the engine is switched off, it is not possible to shift out of park position P . ► Depress the brake pedal and start the engine.
Start Engine to Engage Gear	The gear cannot be engaged when the engine is switched off. ► Depress the brake pedal and start the engine.
Depress Brake to Start Engine	You cannot start the engine. The engine was switched off in position D or R . ► Depress the brake pedal and start the engine.
Door Open Vehicle Not in 'P'	The driver's door is open and the transmission is in position R , N or D . A warning tone also sounds. ► Shift the transmission to P using the button on the center console. ► Press the electric parking brake handle.

Display messages	Possible causes/consequences and ► Solutions
<p>Service Required Do Not Shift Gears Visit Dealer</p>	<p>You cannot change gear due to a malfunction. A warning tone also sounds.</p> <p>If transmission position D is selected:</p> <ul style="list-style-type: none"> ► Do not switch off the engine. ► Drive to a qualified specialist workshop without shifting the transmission from position D. <p>If transmission position R, N or P is selected:</p> <ul style="list-style-type: none"> ► Make sure that the electric parking brake is applied. ► Prevent the vehicle from rolling away before you leave it (▷ page 236). ► Notify a qualified specialist workshop or breakdown service. <p>If no transmission position and no drive program is displayed:</p> <ul style="list-style-type: none"> ► Make sure that the electric parking brake is applied. ► Prevent the vehicle from rolling away before you leave it (▷ page 236). ► Notify a qualified specialist workshop or breakdown service.
<p>Only select Park (P) when vehicle is stationary</p>	<p>The vehicle is moving.</p> <ul style="list-style-type: none"> ► Pull over and stop the vehicle safely as soon as possible, paying attention to road and traffic conditions. ► Shift the transmission to P using the button on the center console.
<p>backing up not poss. Consult workshop</p>	<p>The sub geartrain with the even gears has failed. You can no longer engage reverse gear. The smoothness of the gear change is restricted. The transmission is in emergency mode.</p> <ul style="list-style-type: none"> ► Visit a qualified specialist workshop.
<p>P Parking lock malfunct. Apply parking brake</p>	<p>Transmission position P cannot be selected.</p> <ul style="list-style-type: none"> ► Make sure that the electric parking brake is applied. ► Prevent the vehicle from rolling away before you leave it (▷ page 236). ► Visit a qualified specialist workshop. Have the vehicle transported on a recovery vehicle or towed with the rear axle raised (▷ page 244).







Display messages	Possible causes/consequences and ► Solutions
 <p>Stop Engage P</p>	<p>The transmission is faulty. The vehicle loses drive and rolls to a standstill.</p> <ul style="list-style-type: none"> ▶ Pull over and stop the vehicle safely as soon as possible, paying attention to road and traffic conditions. ▶ Make sure that the electric parking brake is applied. ▶ Prevent the vehicle from rolling away before you leave it (> page 236). ▶ Consult a qualified specialist workshop.
 <p>Transmission oil cooling Malfunction</p>	<p>The transmission coolant pump is faulty. The transmission may overheat.</p> <ul style="list-style-type: none"> ▶ In the on-board computer, select the AMG menu and check the transmission oil temperature. ▶ Avoid excessive loading, e.g. due to dynamic driving. ▶ At transmission oil temperatures under 248 °F(120 °C), drive to the nearest qualified specialist workshop.
 <p>Trans. oil overheated Drive on with care</p>	<p>The transmission oil has overheated.</p> <p>Manual drive program M and shift range restriction are no longer available. Only drive program C is still available. The engine output is reduced according to the degree of overheating.</p> <ul style="list-style-type: none"> ▶ Allow the transmission oil to cool by adopting a defensive driving style.

Rear spoiler

Display messages	Possible causes/consequences and ► Solutions
 <p>Rear Spoiler Control System Inoperative</p>	<p>The rear spoiler cannot be fully retracted and may extend again. If the retraction of the rear spoiler is blocked, e.g. by ice:</p> <ul style="list-style-type: none"> ► Make sure that the cause of the block is eliminated. ► Switch off the engine and lock the vehicle. ► Start the vehicle after waiting a few minutes. The rear spoiler returns to the original position. <p>If this problem persists or the cause cannot be identified:</p> <ul style="list-style-type: none"> ► Visit a qualified specialist workshop.
 <p>Rear Spoiler Inoperative Limit 200 km/h</p>	<p>The rear spoiler cannot be fully extended and extends as far as possible. The vehicle's speed is limited to 125 mph(200 km/h). If the extension/retraction of the rear spoiler is blocked, e.g. by ice:</p> <ul style="list-style-type: none"> ► Make sure that the cause of the block is eliminated. ► Switch off the engine and lock the vehicle. ► Start the vehicle after waiting a few minutes. The rear spoiler returns to the original position. <p>If this problem persists or the cause cannot be identified:</p> <ul style="list-style-type: none"> ► Visit a qualified specialist workshop.

Warning and indicator lamps in the instrument cluster

Brakes









Problem	Possible causes/consequences and ► Solutions
<p> The red brake system warning lamp comes on while the engine is running. A warning tone also sounds.</p> <p>(USA only)</p> <p> (Canada only)</p>	<p> Risk of accident</p> <p>There is not enough brake fluid in the brake fluid reservoir.</p> <ul style="list-style-type: none"> ► Pull over and stop the vehicle safely as soon as possible, paying attention to road and traffic conditions. Do not continue driving under any circumstances. ► Consult a qualified specialist workshop immediately. ► Observe the additional messages in the multifunction display (> page 165). <p>Do not add brake fluid. This will not rectify the malfunction.</p>
<p> The indicator lamp for the electric parking brake flashes and/or the yellow warning lamp for the electric parking brake lights up.</p> <p>(USA only)</p> <p> (Canada only)</p>	<p> Risk of accident</p> <p>The electric parking brake is temporarily malfunctioning or defective.</p> <ul style="list-style-type: none"> ► Observe the additional display messages in the multifunction display.

 **WARNING**







Driving with the brake warning lamp illuminated can result in an accident. Have your brake system checked immediately if the brake warning lamp stays on. Do not add brake fluid before checking the brake system.







Overfilling the brake fluid reservoir can result in spilling brake fluid on hot engine parts and the brake fluid catching fire. You can be seriously burned.

Seat belts

Problem	Possible causes/consequences and ► Solutions
 After starting the engine, the red seat belt warning lamp lights up for six seconds.	<p>The seat belt warning lamp reminds the driver and front passenger to fasten their seat belts.</p> <ul style="list-style-type: none"> ► Fasten your seat belt (▷ page 49).
 After the engine starts, a warning tone sounds for up to six seconds.	<p> Risk of injury</p> <p>The driver's seat belt is not fastened.</p> <ul style="list-style-type: none"> ► Fasten your seat belt (▷ page 49). The warning tone ceases.
 The red seat belt warning lamp lights up after the engine starts, as soon as the driver's door or the front-passenger door is closed.	<p> Risk of injury</p> <p>The driver or front passenger has not fastened their seat belt.</p> <ul style="list-style-type: none"> ► Fasten your seat belt (▷ page 49). The warning lamp goes out.
	<p> Risk of injury</p> <p>There are objects on the front-passenger seat.</p> <ul style="list-style-type: none"> ► Remove the objects from the front-passenger seat and stow them in a secure place. The warning lamp goes out.
 The red seat belt warning lamp flashes and an intermittent audible warning sounds.	<p> Risk of injury</p> <p>The driver or front passenger has not fastened their seat belt. In addition, you are driving faster than 15 mph (25 km/h) or you have briefly driven faster than 15 mph(25 km/h).</p> <ul style="list-style-type: none"> ► Fasten your seat belt (▷ page 49). The warning lamp goes out and the intermittent audible warning ceases. <p> Risk of injury</p> <p>There are objects on the front-passenger seat. In addition, you are driving faster than 15 mph (25 km/h) or you have briefly driven faster than 15 mph(25 km/h).</p> <ul style="list-style-type: none"> ► Remove the objects from the front-passenger seat and stow them in a secure place. The warning lamp goes out and the intermittent audible warning ceases.

Safety systems

Problem	Possible causes/consequences and ► Solutions
 The yellow ABS warning lamp is lit while the engine is running.	<p> Risk of accident</p> <p>ABS (Anti-lock Brake System) is deactivated due to a malfunction. Therefore ESP® (Electronic Stability Program), BAS (Brake Assist) and hill start assist are also deactivated, for example.</p> <p>The brake system continues to function normally, but without the functions listed above. The wheels could therefore lock if you brake hard, for example.</p> <ul style="list-style-type: none"> ► Observe the additional messages in the multifunction display (► page 170). ► Drive on carefully. ► Visit a qualified specialist workshop.
 The yellow ESP® and ESP® OFF warning lamps and the yellow ABS warning lamp are lit while the engine is running.	<p> Risk of accident</p> <p>ABS and ESP® are faulty. Other systems, e.g. BAS and hill start assist, are unavailable due to a malfunction. The brake system continues to function normally, but without the functions listed above. The wheels could therefore lock if you brake hard, for example.</p> <ul style="list-style-type: none"> ► Observe the additional messages in the multifunction display (► page 170). ► Drive on carefully. ► Visit a qualified specialist workshop.
 The yellow ESP® warning lamp flashes while the vehicle is in motion.	<p> Risk of accident</p> <p>ESP® or traction control has intervened because there is a risk of skidding or at least one wheel has started to spin.</p> <ul style="list-style-type: none"> ► When pulling away, only depress the accelerator pedal as far as necessary. ► Release the accelerator pedal while the vehicle is in motion. ► Adapt your driving style to suit the road and weather conditions. ► Do not deactivate ESP®. <p>For exceptions: (► page 56).</p>



Problem	Possible causes/consequences and ► Solutions
 The yellow SPORT handling mode warning lamp is lit while the engine is running.	<p> Risk of accident</p> <p>SPORT handling mode is activated. ESP® only stabilizes the vehicle in extreme situations. ESP® intervention may not be able to provide enough assistance in such situations, and the vehicle may start to skid.</p> <ul style="list-style-type: none"> ► Reactivate ESP®. <p>For exceptions: (► page 56).</p>
 The yellow ESP® and ESP® OFF warning lamps are lit while the engine is running.	<p> Risk of accident</p> <p>ESP® is not available due to a malfunction. ESP® will not stabilize the vehicle if it starts to skid or if a wheel starts to spin. The brake system continues to function normally, but without ESP®.</p> <ul style="list-style-type: none"> ► Drive on carefully. ► Visit a qualified specialist workshop.
 The red SRS warning lamp is lit while the engine is running.	<p> Risk of injury</p> <p>The restraint systems are malfunctioning. The air bags or ETDs may either be triggered unintentionally or, in the event of an accident, not be triggered at all.</p> <ul style="list-style-type: none"> ► Visit a qualified specialist workshop immediately.



 **WARNING**

In the event a malfunction of the SRS is indicated as outlined above, the SRS may not be operational.

For your safety, we strongly recommend that you contact an authorized Mercedes-Benz Center immediately to have the system checked. Otherwise the SRS may not be activated when needed in an accident, which could result in serious or fatal injury, or it might deploy unexpectedly and unnecessarily which could also result in injury.

Engine

Problem	Possible causes/consequences and ► Solutions
 The yellow Check Engine warning lamp lights up while the engine is running.	<p>There may be a malfunction, for example:</p> <ul style="list-style-type: none"> • in the engine management • in the fuel injection system • in the exhaust system • in the ignition system <p>The emission limit values may be exceeded and the engine may be running in emergency mode.</p> <p>► Have the vehicle checked as soon as possible at a qualified specialist workshop.</p> <p>i In some states/provinces, you are required by law to immediately visit a qualified specialist workshop as soon as the yellow Check Engine warning lamp lights up. If in doubt, check whether such legal regulations apply in the state/province in which you are currently driving.</p>
 The yellow Check Engine warning lamp lights up while the engine is running. The smoothness of the gear change is restricted.	<p>The sub geartrain with the odd gears has failed. The transmission is in emergency mode.</p> <p>► Have the vehicle checked as soon as possible at a qualified specialist workshop.</p>
 The red engine oil temperature warning lamp comes on while the engine is running. A warning tone also sounds.	<p>The engine oil temperature has exceeded 284 °F (140 °C). The engine is not being cooled sufficiently and may be damaged.</p> <p>► Pull over and stop the vehicle safely and switch off the engine, paying attention to road and traffic conditions.</p> <p>► Allow the engine to cool down.</p>

Problem	Possible causes/consequences and ► Solutions
 <p>The red engine oil temperature warning lamp comes on while the engine is running. The engine oil temperature is not displayed.</p>	<p>The engine control unit data transfer is malfunctioning.</p> <ul style="list-style-type: none"> ► Visit a qualified specialist workshop.
 <p>The yellow reserve fuel warning lamp lights up while the engine is running.</p>	<p>The fuel level has dropped into the reserve range.</p> <ul style="list-style-type: none"> ► Refuel at the nearest gas station.
 <p>The yellow reserve fuel warning lamp flashes while the engine is running.</p>	<p>The fuel system pressure is too low. The fuel filler cap is not closed correctly or the fuel system is leaking.</p> <ul style="list-style-type: none"> ► Check that the fuel filler cap is correctly closed. ► If the fuel filler cap is not correctly closed: close the fuel filler cap. ► If the fuel filler cap is closed: visit a qualified specialist workshop.

 **WARNING**



Driving when your engine is overheated can cause some fluids which may have leaked into the engine compartment to catch fire. You could be seriously burned.

Steam from an overheated engine can cause serious burns which can occur just by opening the engine hood. Stay away from the engine if you see or hear steam coming from it.

Stop the vehicle in a safe location away from other traffic. Turn off the engine, get out of the vehicle and do not stand near the vehicle until the engine has cooled down.

 **!** If the coolant temperature exceeds 248 °F(120 °C) do not continue driving. The engine will otherwise be damaged.

Tires

Problem	Possible causes/consequences and ► Solutions
 USA only: The yellow tire pressure monitor warning lamp (pressure loss/malfunction) is lit. Canada only: The yellow tire pressure monitor warning lamp (pressure loss) is lit.	 Risk of accident The tire pressure monitor has detected a loss of pressure in at least one of the tires. <ul style="list-style-type: none"> ► Stop the vehicle without making any sudden steering or braking maneuvers. Pay attention to the traffic conditions as you do so. ► Observe the additional display messages in the multifunction display. ► Check the tire pressure. If necessary, correct the tire pressure (▷ page 257). ► If necessary, change a wheel (▷ page 271).
 USA only: The yellow tire pressure monitor warning lamp (pressure loss/malfunction) flashes for 60 seconds and then remains lit.	The tire pressure monitor is faulty. <ul style="list-style-type: none"> ► Observe the additional display messages in the multifunction display. ► Visit a qualified specialist workshop.

 **WARNING**

Each tire, including the spare (if provided), should be checked at least every two weeks when cold and inflated to the pressure recommended by the vehicle manufacturer on the Tire and Loading Information placard on the driver's door B-pillar or, if available, the tire pressure label on the inside of the fuel filler flap. If your vehicle has tires of a different size than the size indicated on the Tire and Loading Information placard or the tire pressure label, you should determine the proper tire pressure for those tires.

As an added safety feature, your vehicle has been equipped with a tire pressure monitoring system (TPMS) that illuminates a low tire pressure telltale when one or more of your tires are significantly underinflated. Accordingly, when the low tire pressure telltale illuminates, you should stop and check your tires as soon as possible, and inflate them to the proper pressure. Driving on a significantly underinflated tire causes the tire to overheat and can lead to tire failure.

Underinflation also reduces fuel efficiency and tire tread life, and may affect the vehicle's handling and stopping ability. Please note that the TPMS is not a substitute for proper tire maintenance, and it is the driver's responsibility to maintain correct tire pressure, even if underinflation has not reached the level to trigger illumination of the TPMS low tire pressure telltale.

USA only:

Your vehicle has also been equipped with a TPMS malfunction indicator to indicate when the system is not operating properly. The TPMS malfunction indicator is combined with the low tire pressure telltale. When the system detects a malfunction, the telltale will flash for approximately 1 minute and then remain continuously illuminated. This sequence will be repeated every time

the vehicle is started as long as the malfunction exists. When the malfunction indicator is illuminated, the system may not be able to detect or signal low tire pressure as intended.

TPMS malfunctions may occur for a variety of reasons, including the installation of incompatible replacement or alternate tires or wheels on the vehicle that prevent the TPMS from functioning properly. Always check the TPMS malfunction telltale after replacing one or more tires or wheels on your vehicle to ensure that the replacement or alternate tires and wheels allow the TPMS to continue to function properly.

Useful information	200
Stowage areas	200
Features	202

Useful information

- i** This Operator's Manual describes all models and all standard and optional equipment of your vehicle available at the time of publication of the Operator's Manual. Country-specific differences are possible. Please note that your vehicle may not be equipped with all features described. This also applies to safety-related systems and functions.
- i** Please read the information on qualified specialist workshops (▷ page 21).

Stowage areas

Stowage space

Important safety notes

WARNING

To help avoid personal injury during a collision or sudden maneuver, exercise care when storing objects in the vehicle. Put luggage or cargo in the trunk if possible.

Keep compartment lids closed. This will help to prevent stored objects from being thrown about and injuring vehicle occupants during

- braking
- vehicle maneuvers
- an accident

Stowage compartments in the front

Glove box

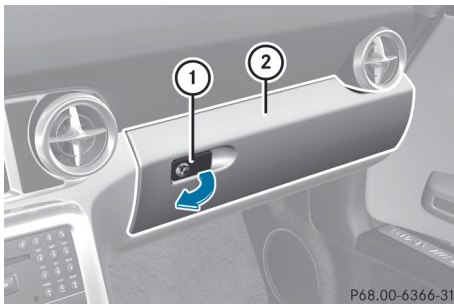

- ▶ **To open:** pull handle ① and open glove box flap ②.
- ▶ **To close:** fold glove box flap ② upwards until it engages.

The glove box can be locked and unlocked using the mechanical key, e.g. when leaving your vehicle at a workshop.

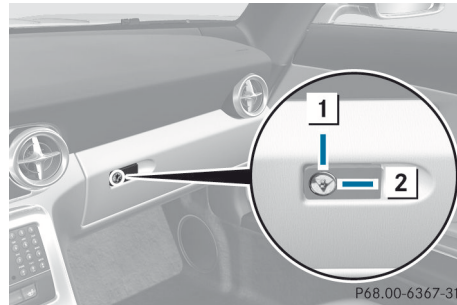

- ▶ **To lock:** insert the mechanical key into the lock and turn it 90° clockwise to position ②.
- ▶ **To unlock:** insert the mechanical key into the lock and turn it 90° counter-clockwise to position ①.

- i Roadster:** the glove box can be locked and unlocked centrally using the SmartKey (▷ page 64).
- i** Depending on the vehicle's equipment, you will find an AUX IN jack or a Media Interface installed in the glove box. A Media Interface is a universal interface for portable audio equipment, e.g. for an iPod® or USB device (see the separate COMAND operating instructions).
- i** There is a 12 V power socket located in the glove box.

Stowage compartment in the center console



P68.00-6801-31

- ▶ **To open:** press down at the middle of the marking on lid ①.
- ▶ **To close:** fold down cover ①.
- i** Depending on the equipment installed, your vehicle is equipped with an ashtray or a stowage compartment.

Stowage compartment under the armrest

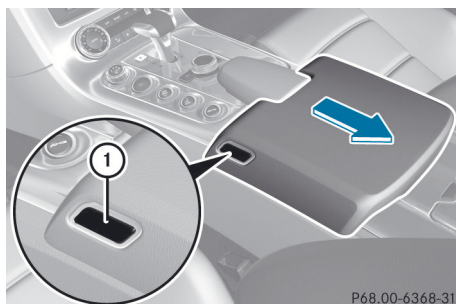

P68.00-6368-31

- ▶ **To open:** press button ① on the left or right and slide the armrest in the direction of the arrow.
The armrest engages in two different detents.
- i Roadster:** the stowage compartment can be locked and unlocked centrally using the SmartKey (▶ page 64).

Stowage compartment in the rear center console

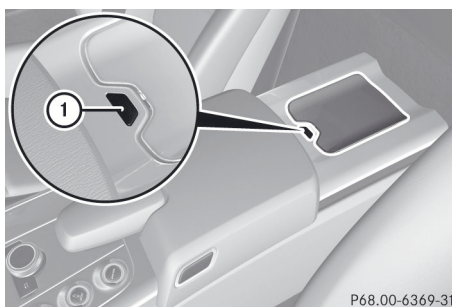

P68.00-6369-31

- ▶ Press button ①.
The stowage compartment opens.
- i** In the stowage compartment, you will find the ignition lock (▶ page 115) and the trunk lid emergency release (▶ page 75).

Stowage space in the rear

Stowage space on the rear wall between the seats

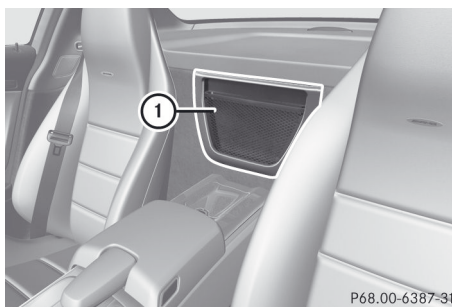

P68.00-6387-31

- ① Ruffled pocket

Luggage nets

⚠ WARNING

Parcel nets are intended for storing light-weight items only, such as road maps, mail, etc.

Heavy objects, objects with sharp edges, or fragile objects may not be transported in the parcel nets. In an accident, during hard

braking, or sudden maneuvers, they could be thrown around inside the vehicle and cause injury to vehicle occupants.

Parcel nets cannot protect transported goods in the event of an accident.

There is a parcel net located in the front-passenger footwell.

Features

Cup holders

Important safety notes

WARNING

In order to help prevent spilling liquids on vehicle occupants and/or vehicle equipment, only use containers that fit into the cup holder. Use lids on open containers and do not fill containers to a height where the contents, especially hot liquids, could spill during braking, vehicle maneuvers, or in an accident. Liquids spilled on vehicle occupants may cause serious personal injury. Liquids spilled on vehicle equipment may cause damage not covered by the Mercedes-Benz Limited Warranty.

When not in use, keep the cup holder closed. An open cup holder may cause injury to you or others when contacted during braking, vehicle maneuvers, or in an accident.

Keep in mind that objects placed in the cup holder may come loose during braking, vehicle maneuvers, or in an accident and be thrown around in the vehicle interior. Objects thrown around in the vehicle interior may cause an accident and/or serious personal injury.

Cup holder in the center console

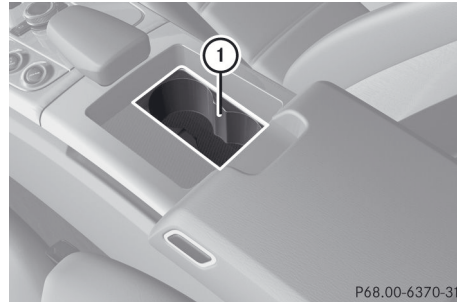

P68.00-6370-31

Coupe (example)

- ▶ Open the armrest (▷ page 201).
Cupholders ① are under the armrest.

Sun visors

Overview of sun visors

WARNING

Do not use the vanity mirror while driving. Keep the vanity mirrors in the sun visors closed while the vehicle is in motion. Reflected glare can endanger you and others.

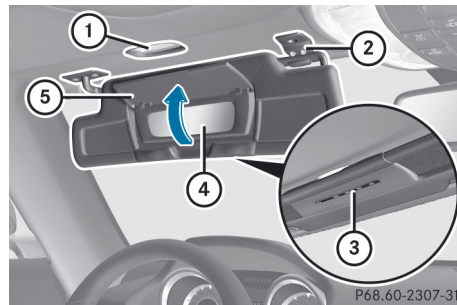

P68.60-2307-31

Coupe (example)

- ① Mirror light
- ② Bracket
- ③ Retaining strip, e.g. for a car park ticket
- ④ Vanity mirror
- ⑤ Mirror cover

Vanity mirror in the sun visor

Mirror light ① only functions if the sun visor is clipped into retainer ② and mirror cover ⑤ has been folded up.

Glare from the side

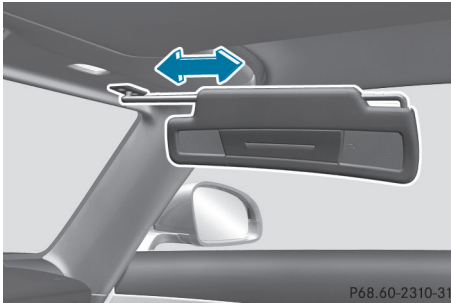

Coupe (example)

- ▶ Fold down the sun visor.
- ▶ Pull the sun visor out of retainer ②.
- ▶ Swing the sun visor to the side.
- ▶ Slide the sun visor forwards and back as required.

Ashtray

Ashtray in the cockpit

- i** You can remove the ashtray insert and use the resulting compartment for stowage.
- !** The stowage space under the ashtray is not heat resistant. Before placing lit cigarettes in the ashtray, make sure that the ashtray is properly engaged. Otherwise, the stowage space could be damaged.

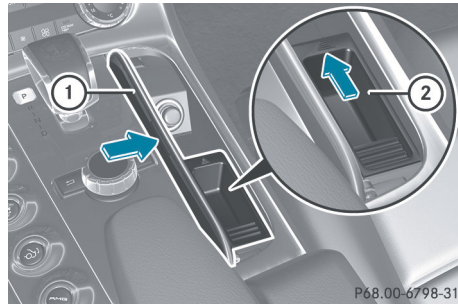

Coupe (example)

- ▶ **To open:** lightly press the center of cover ①.
The ashtray opens.
- ▶ **To remove the insert:** slide insert ② forwards in the direction of the arrow.
- ▶ Remove insert ②.
- ▶ **To re-install the insert:** place the insert into the holder and press it in the opposite direction of the arrow until it engages.
- ▶ **To close:** fold down cover ①.

Cigarette lighter

⚠ WARNING

When leaving the vehicle, always remove the SmartKey from the ignition lock. Always take the SmartKey with you and lock the vehicle. Do not leave children unattended in the vehicle, even if they are secured in a child restraint system, or with access to an unlocked vehicle. A child's unsupervised access to a vehicle could result in an accident and/or serious personal injury. The children could:

- injure themselves on parts of the vehicle
- be seriously or fatally injured through excessive exposure to extreme heat or cold
- injure themselves or cause an accident with vehicle equipment that can be operated even if the SmartKey is removed from the ignition lock or removed from the vehicle,

such as seat adjustment, steering wheel adjustment, or the memory function

If children open a door, they could injure other persons or get out of the vehicle and injure themselves or be injured by following traffic.

Do not expose the child restraint system to direct sunlight. The child restraint system's metal parts, for example, could become very hot, and the child could be burned on these parts.

WARNING

Never touch the heating element or sides of the lighter; they are extremely hot. Hold the knob only.

Make sure any children traveling with you do not injure themselves or start a fire with the hot cigarette lighter.



Coupe (example)

- ▶ Select key position **2** with the Start/Stop button.
- ▶ Lightly press the center of cover **1**. The ashtray opens.
- ▶ Press in cigarette lighter **2**. Cigarette lighter **2** will pop out automatically when the heating element is red-hot.

12 V sockets

Points to observe before use

The sockets can be used for accessories with a maximum current draw of 180 W (15 A), e.g. lamps or chargers for mobile phones.

If you use the sockets for long periods when the engine is switched off, the battery may discharge.

- i** You can also use the sockets when the ignition is switched off. An emergency cut-out ensures that the on-board voltage does not drop too low. If the on-board voltage is too low, the power to the sockets is automatically cut. This ensures that there is sufficient power to start the engine.

Socket in the glove box

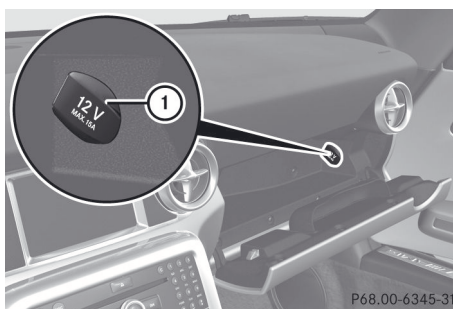

- ▶ Open the glove box (▷ page 200). Lift up the cover of socket **1**.

Socket on the center console

- !** If accessories are connected, make sure that a maximum current draw of 15 A is not exceeded. Otherwise, you will overload the fuse.

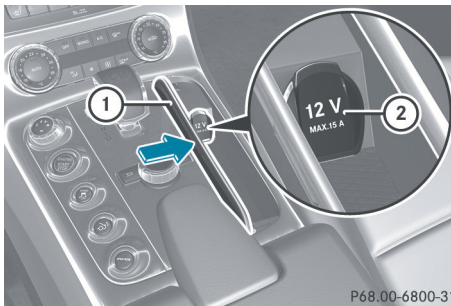

Coupe (example)

- ▶ **To open:** lightly press the center of cover ①.
The stowage compartment opens.
- ▶ Lift up the cover of socket ②.
- ▶ **To close:** fold down cover ①.

mbrace¹²

Important safety notes

I A license agreement must exist in order to activate the mbrace service. Ensure that your system is activated and ready for use, and press the  MB Info call button to register. If any of the steps mentioned is not carried out, the system may not be activated.

If you have questions about the activation, contact one of the following telephone assistance services:

- **USA:** Mercedes-Benz Customer Assistance Center under 1-800-FOR-MERCEdes (1-800-367-6372) or 1-888-990-9007
- **Canada:** Customer Service at 1-888-923-8367

Shortly after successfully registering with the mbrace service, a user ID and password will be sent to you by mail. You can use this password to log in to the mbrace section

¹² The system is called TELE AID in Canada.

¹³ USA only.

¹⁴ USA only.

under "Owners Online" at <http://www.mbusa.com>¹³.

The mbrace system is available if:

- it has been activated and is operational.
- the corresponding mobile phone network is available for transmitting data to the Customer Center.
- a service subscription is available.
- the starter battery is sufficiently charged.



i Determining the location of the vehicle on a map is only possible if there is sufficient GPS reception and the vehicle position can be forwarded to the Customer Center.

The mbrace system

The mbrace system provides various services, e.g.:

- automatic and manual emergency call
- Roadside Assistance call
- MB Info call

To adjust the volume during an mbrace call, proceed as follows:

- ▶ Press the  or  button on the multifunction steering wheel.

or

- ▶ Use the volume controller of COMAND.





You can find further information and a description of all available features under "Owners Online" at <http://www.mbusa.com>¹⁴.

Self-diagnosis of the system

After you have switched on the ignition, the system carries out a self-diagnosis.

⚠ WARNING

A malfunction in the system has been detected if one of the following conditions occurs:

- the indicator lamp in the SOS button does not light up during the system self-diagnosis.
- the indicator lamp in the  Roadside Assistance button does not light up during the system self-diagnosis.
- The indicator lamp in the  information button does not light up during self-diagnosis of the system.
- the indicator lamp in the SOS button,  Roadside Assistance button or  information button continues to be lit red after the system self-diagnosis.
- The **Tele Aid Inoperative** or **Tele Aid Not Activated** message appears in the multifunction display after the system self-test.

If a malfunction is indicated as outlined above, the system may not operate as expected. In the event of an emergency, assistance must be summoned by other means.

Have the system checked at the nearest authorized Mercedes-Benz Center or contact the following service hotlines:

- **USA:** Mercedes-Benz Customer Assistance Center under 1-800-FOR-MERCEdes(1-800-367-6372) or 1-888-990-9007
- **Canada:** Customer Service at 1-888-923-8367

Emergency call**Important safety notes**

! A license agreement must exist in order to activate the mbrace service. Ensure that your system is activated and ready for use, and press the  MB Info call button to register. If any of the steps mentioned is not carried out, the system may not be activated.

If you have questions about the activation, contact one of the following telephone assistance services:

- **USA:** Mercedes-Benz Customer Assistance Center under 1-800-FOR-MERCEdes (1-800-367-6372) or 1-888-990-9007
- **Canada:** Customer Service at 1-888-923-8367

An emergency call is dialed automatically if an air bag or Emergency Tensioning Device is triggered.

i An mbrace emergency call that has been initiated automatically cannot be terminated by the customer.

An emergency call can also be initiated manually.

As soon as the emergency call has been initiated, the indicator lamp in the SOS button flashes. The **Connecting Call** message appears on the multifunction display.

The audio output is muted.

Once a connection has been established, the **Call Connected** message appears on the multifunction display.

All important information on the emergency is transmitted, for example:

- current location of the vehicle (as determined by the GPS system)
- vehicle identification number
- information on the type of emergency

Shortly after the emergency call has been initiated, a voice connection is automatically established between the Mercedes-Benz Customer Assistance Center and the vehicle occupants. If the vehicle occupants respond, the Mercedes-Benz Customer Assistance Center attempts to get more information on the emergency.

i If there is no response from the vehicle occupants, an ambulance is immediately sent to the vehicle.

WARNING

If the indicator lamp in the SOS button is flashing continuously and there was no voice connection to the Response Center established, then the mbrace system could not initiate an emergency call (e.g. the relevant cellular phone network is not available).

The message **Call Failed** appears in the multifunction display for approximately 10 seconds.

Should this occur, assistance must be summoned by other means.

Making an emergency call

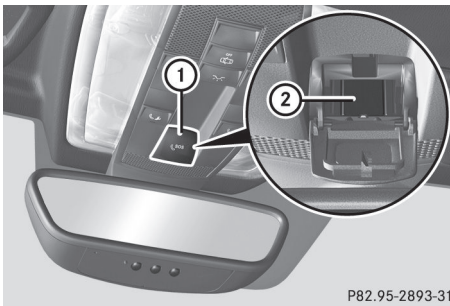

- ▶ **To initiate an emergency call manually:** press cover ① briefly to open it.
- ▶ Press SOS button ② briefly. The indicator lamp in SOS button ② flashes until the emergency call is concluded.
- ▶ Wait for a voice connection to the Mercedes-Benz Customer Assistance Center.
- ▶ After the emergency call is ended, close cover ①.

WARNING

If you feel at any way in jeopardy when in the vehicle (e.g. smoke or fire in the vehicle, vehicle in a dangerous road location), please do not wait for voice contact after you have pressed the SOS button. Carefully leave the vehicle and move to a safe location. The

Response Center will automatically contact local emergency officials with the vehicle's approximate location if they receive an automatic SOS signal and cannot make voice contact with the vehicle occupants.

Roadside Assistance button



- ▶ Press and hold Roadside Assistance button ① for more than two seconds. This initiates a call to the Mercedes-Benz Customer Assistance Center. The indicator lamp in Roadside Assistance button ① flashes while the call is active. The **Connecting Call** message appears in the multifunction display. The audio output is muted.

If a connection can be made, the **Call Connected** message appears in the multifunction display.

If a cellular phone network is available and there is sufficient GPS reception, the mbrace system transmits data to the Mercedes-Benz Customer Assistance Center, for example:

- current location of the vehicle
- vehicle identification number

i The COMAND display shows that an mbrace call is active. During the call, you can change to the navigation menu by pressing the NAVI button on COMAND, for example.

Voice output is not available.

A voice connection is established between the Mercedes-Benz Customer Assistance Center and the vehicle occupants.

- ▶ Describe the type of assistance needed.

The Mercedes-Benz Customer Assistance Center either sends a qualified Mercedes-Benz technician or organizes for your vehicle to be transported to the nearest authorized Mercedes-Benz Center. You may be charged for services such as repair work and/or towing. Further details are available in your mbrace manual.

- i** The mbrace system failed to initiate a Roadside Assistance call if:
 - the indicator lamp in Roadside Assistance button ① is flashing continuously.
 - no voice connection to the Mercedes-Benz Customer Assistance Center was established.

This may be because the corresponding mobile phone network is not available.

The **Call Failed** message appears on the multifunction display.

- ▶ **To end a call:** press the  button on the multifunction steering wheel.

or

- ▶ Press the corresponding button for ending a phone call on COMAND.

MB Info call button

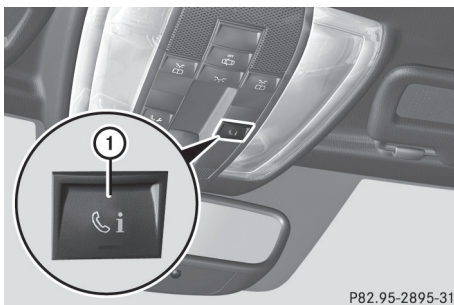

P82.95-2895-31

- ▶ Press and hold MB Info call button ① for more than two seconds. This initiates a call to the Mercedes-Benz Customer Assistance Center. The indicator lamp in MB Info call button ① flashes while the connection is being established. The **Connecting Call** message appears in the multifunction display and COMAND is muted.

If a connection can be made, the **Call Connected** message appears in the multifunction display.

If a cellular phone network is available and there is sufficient GPS reception, the mbrace system transmits data to the Mercedes-Benz Customer Assistance Center, for example:

- current location of the vehicle
- vehicle identification number

- i** The COMAND display shows that an mbrace call is active. During the call, you can change to the navigation menu by pressing the NAVI button on COMAND, for example.

Voice output is not available.

A voice connection is established between the Mercedes-Benz Customer Assistance Center and the vehicle occupants. You can obtain information on how to operate your vehicle's systems, on the location of the nearest authorized Mercedes-Benz Center, and on further products and services offered by Mercedes-Benz USA.

Further details on the mbrace system can be found under <http://www.mbusa.com>¹⁵. Log in under "Owners Online".

- i** The mbrace system failed to initiate an MB Info call if:
 - the indicator lamp in MB Info call button ① is flashing continuously.
 - no voice connection to the Mercedes-Benz Customer Assistance Center was established.

¹⁵ USA only.

This may be because the corresponding mobile phone network is not available.

The **Call Failed** message appears on the multifunction display.

- ▶ **To end a call:** press the  button on the multifunction steering wheel.
- or
- ▶ Press the corresponding button for ending a phone call on COMAND.

Call priority

When service calls are active, e.g. Roadside Assistance or MB Info calls, an emergency call can still be initiated. In this case, an emergency call will take priority and override all other active calls.

The indicator lamp of the respective button flashes until the call is ended. An emergency call can only be terminated by the Mercedes-Benz Customer Assistance Center. All other calls can be ended by pressing the  button on the multifunction steering wheel or the corresponding button for ending a telephone call on COMAND.

- ❗ If an mbrace call is initiated, audio output is muted. The mobile phone is no longer connected to COMAND. However, if you want to use your mobile phone, we recommend that you do this only when the vehicle is stationary and in a safe location.

Downloading destinations in COMAND

- ❗ Information on the components and operating principles of COMAND can be found in the separate COMAND operating instructions.

This service is part of the mbrace PLUS Package and cannot be purchased separately.

- ❗ You can only use the Destination Download function if the vehicle is equipped with a navigation system.

Destination Download gives you access to a database with over 15 million points of interest (POIs)/important destinations that can be downloaded onto the navigation system of your vehicle. If you know the destination, you can download the address or obtain the location of points of interest (POIs)/important destinations in the surrounding area.

You are prompted to confirm route guidance to the address entered.

The system calculates the route and subsequently starts the route guidance with the address entered.

- ❗ If you select **No**, the address can be stored in the address book.
- ❗ The Destination Download function is available if the corresponding mobile phone network is available and data transfer is possible.

Route Assistance

This service is part of the mbrace PLUS Package and cannot be purchased separately.

- ❗ You can also use the Route Assistance function if your vehicle is not equipped with a navigation system.

Within the framework of this service, you receive a professional and reliable form of navigation support without having to leave your vehicle.

The customer service representative determines a suitable driving route based on your current vehicle position and the desired destination and guides you live through the current sections of the route.

Search & Send

"Search & Send" is a destination entry service. You can find further information on "Search & Send" in the separate COMAND operating instructions.

Vehicle remote closing

If you forget to lock your vehicle but are no longer in the vicinity of the vehicle, it can be locked for you by the Mercedes-Benz Customer Assistance Center.

The vehicle can be locked remotely up to four days after the ignition was last switched off.

- ▶ Contact the following service hotlines:
 - **USA:** Mercedes-Benz Customer Assistance Center under 1-800-FOR-MERCEdes (1-800-367-6372) or 1-888-990-9007
 - **Canada:** Customer Service at 1-888-923-8367
- You will be asked for your PIN.

The next time you are in your vehicle and switch on the ignition, the **Tele Aid Doors Locked Remotely** message appears in the multifunction display.

Alternatively, the vehicle can also be locked via the Internet or an iPhone in the "Owners Online" section using your ID number and password.

- ❗ The vehicle valet locking feature is available when the relevant mobile phone network is available and data connection is possible.

Service for recovering a stolen vehicle

If your vehicle has been stolen:

- ▶ Notify the police.

The police will issue a numbered incident report.
- ▶ This number will be forwarded to the Mercedes-Benz Customer Assistance Center together with your PIN.

The Mercedes-Benz Customer Assistance Center then attempts to locate the mbrace system. The Mercedes-Benz Customer Assistance Center contacts you and the local law enforcement agency if the vehicle is located. However, only the law enforcement agency is informed of the location of the vehicle.

- ❗ If the anti-theft alarm system is active for longer than 30 seconds, mbrace automatically informs the Mercedes-Benz Customer Assistance Center.

Rear spoiler

The rear spoiler improves the handling of the vehicle. It adapts the vehicle's aerodynamics to the operating conditions, dependent on the speed of the vehicle.

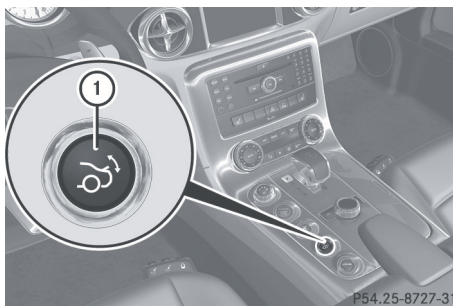

Coupe (example)

- ❗ If the vehicle is equipped with AMG adaptive sport suspension system, the button is in the switch strip above the air conditioning control panel.

Only use button ① to extend and retract the rear spoiler manually for cleaning. Button ① is not used to operate the rear spoiler.

If you are driving faster than 75 mph (120 km/h), the rear spoiler automatically extends. Button ① flashes until the rear spoiler has extended and then lights up in red.

If you then continue to drive no slower than 50 mph (80 km/h), the rear spoiler remains extended. Button ① remains lit in red.

If you then drive slower than 50 mph (80 km/h), the rear spoiler retracts automatically. Button ① flashes until the rear spoiler has retracted and then goes out.

Extending and retracting the rear spoiler manually

You can extend and retract the rear spoiler manually for cleaning.

WARNING

During manual retraction of the rear spoiler, make sure that nobody becomes trapped. If there is a danger of someone becoming trapped, release the rear spoiler button to pause retraction. The rear spoiler is then extended again.

Never leave children unsupervised in the vehicle. They could unintentionally retract the extended rear spoiler. Someone could then become trapped and seriously injured.

! Do not enter an automatic car wash with the rear spoiler extended. Otherwise, the rear spoiler may be damaged.

Only extend the rear spoiler in order to clean it by hand. Retract it again when you have finished cleaning it.

- ▶ Close the trunk lid.
- ▶ Select key position **2** with the Start/Stop button.
- ▶ **To extend:** press button ①.
The rear spoiler is extended.
Button ① flashes until the rear spoiler has extended and then lights up in red.
- ▶ **To retract:** press and hold button ① until the rear spoiler is completely retracted.
Button ① flashes until the rear spoiler has retracted and then goes out.

Rear Spoiler retracts manually appears in the display.

- i** If you release button ① while retracting the rear spoiler, it extends again automatically.

Problems with the rear spoiler

Problem	Possible causes/consequences and ► Solutions
The rear spoiler stops before reaching the end position when retracting manually.	You have opened the trunk lid while manually retracting the rear spoiler. ► Close the trunk lid. The rear spoiler extends or, if you press and hold the button ①, continues retracting.
The rear spoiler stops before reaching the end position when retracting/extending manually.	You have switched off the ignition. ► Switch on the ignition again. ► Press button ① to extend/retract the rear spoiler. The rear spoiler extends/retracts.
The rear spoiler cannot be retracted again after manually extending it.	You have opened the trunk lid while manually extending the rear spoiler. ► Close the trunk lid.
The rear spoiler does not extend or retract automatically.	The rear spoiler's movement is blocked, e.g. by an object jammed between the body and the rear spoiler. ► Remove the object.

Garage door opener

Important safety notes

The HomeLink® garage door opener integrated in the rear-view mirror allows you to operate up to three different door and gate systems.

- i** Certain garage door drives are incompatible with the integrated garage door opener. If you experience difficulties programming the integrated garage door opener, contact an authorized Mercedes-Benz Service center.

Alternatively, you can call the following telephone assistance services:

- **USA:** Mercedes-Benz Customer Assistance Center at 1-800-FOR-MERCEdes
- **Canada:** Customer Service at 1-800-387-0100

WARNING

Before programming the integrated remote control to a garage door opener or gate operator, make sure people and objects are out of the way of the device to prevent potential harm or damage. When programming a garage door opener, the door moves up or down. When programming a gate operator, the gate opens or closes.

Do not use the integrated remote control with any garage door opener that lacks safety stop and reverse features as required by U.S. federal safety standards (this includes any garage door opener model manufactured before April 1, 1982). A garage door that cannot detect an object - signaling the door to stop and reverse - does not meet current U.S. federal safety standards.

When programming a garage door opener, park vehicle outside the garage.

Do not run the engine while programming the integrated remote control. Inhalation of exhaust gas is hazardous to your health. All exhaust gas contains carbon monoxide (CO), and inhaling it can cause unconsciousness and possible death. All exhaust gas contains carbon monoxide (CO), and inhaling it can cause unconsciousness and possible death.

i USA only:

this device complies with part 15 of the FCC Rules. Operation is subject to the following two conditions:

1. This device may not cause harmful interference, and
2. this device must accept any interference received, including interference that may cause undesired operation.

Any unauthorized modification to this device could void the user's authority to operate the equipment.

FCC ID: CB2HMIHL4

i Canada only:

This device complies with RSS-210 of Industry Canada. Operation is subject to the following two conditions:

1. This device may not cause harmful interference, and
2. this device must accept any interference received, including interference that may cause undesired operation of the device.

Any unauthorized modification to this device could void the user's authority to operate the equipment.

IC: 279B-HMIHL4

Programming the integrated garage door opener on the rear-view mirror

Programming

⚠ WARNING

Only press the button on the integrated garage door opener if there are no persons or objects present within the sweep of the

garage door. Persons could otherwise be injured as the door moves.

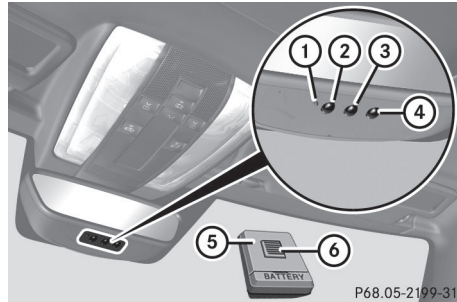

Integrated garage door opener on the rear-view mirror

Garage door remote control ⑤ is not part of the integrated garage door opener.

- ▶ Before programming for the first time, clear the memory of the integrated garage door opener (> page 215).
- ▶ Turn the SmartKey to position **2** in the ignition lock.
- ▶ Press and hold button ② or ④ on the integrated garage door opener. Indicator lamp ① starts to flash yellow after a short period.

i Indicator lamp ① immediately flashes yellow the first time button ②, ③ or ④ is programmed. If the button selected has already been programmed, indicator lamp ① only starts flashing yellow after 10 seconds have elapsed.

- ▶ Release button ②, ③ or ④.
- ▶ Point remote control ⑤ at buttons ② and ④ on the rear-view mirror at a distance from 2 to 8 inches (5 to 20 cm)

i The required distance between remote control ⑤ and the integrated garage door opener depends on the garage door drive system. You might require several attempts. You should test every position for at least 25 seconds before trying another position.

- ▶ Press and hold button ⑥ on remote control ⑤ until indicator lamp ① lights up green. The programming has been successful if indicator lamp ① lights up or flashes green.
- ▶ Release button ②, ③ or ④ on the integrated garage door opener and button ⑥ on garage door remote control ⑤.

If indicator lamp ① lights up red:

- ▶ Repeat the programming operation for the corresponding button on the rear-view mirror. When doing so, vary the distance between remote control ⑤ and the rear-view mirror.

i If the indicator lamp flashes green after successful programming, the garage door system is operating on a rolling code. After programming, you must synchronize the garage door opener integrated in the rear-view mirror with the receiver of the garage door system.

Synchronizing the rolling code

Your vehicle must be within range of the garage or gate opener drive. Make sure that neither your vehicle nor any persons/objects are present within the sweep of the door or gate.

Observe the safety notes when performing the rolling code synchronization (▷ page 212).

- ▶ Turn the SmartKey to position **2** in the ignition lock.
- ▶ Press the programming button of the door or gate drive (see the door or gate drive operating instructions, e.g. under "Programming of additional remote controls").
- i** Usually, you now have 30seconds to initiate the next step.
- ▶ Press the previously programmed button ②, ③ or ④ of the integrated

garage door opener repeatedly until the door starts to move.

The rolling code synchronization is then complete.

Notes on programming the remote control

Canadian radio frequency laws require a "break" (or interruption) of the transmission signals after broadcasting for a few seconds. Therefore, these signals may not last long enough for the integrated remote control. The signal is not recognized during programming. Comparable with Canadian law, some U.S. garage door openers are designed to "time-out" in the same manner.

Proceed as follows:

- if you live in Canada.
- if you have difficulties programming the garage door opener (regardless of where you live) when using the programming steps.
- ▶ Press and hold one of the buttons ② to ④ on the integrated garage door opener. Indicator lamp ① starts to flash yellow after a short period.
- ▶ Release the switch.
- ▶ Press button ⑥ of garage door remote control ⑤ for two seconds, then release it for two seconds.
- ▶ Press button ⑥ again for two seconds.
- ▶ Repeat this sequence on button ⑥ of remote control ⑤ until indicator lamp ① lights up green. Repeat the process if indicator lamp ① turns red.
- ▶ Continue with the other programming steps (see above).

Problems when programming

If you are experiencing problems programming the integrated garage door opener on the rear-view mirror, take note of the following instructions:

- Check remote control frequency of garage door drive remote control ⑤. This is usually located on the back of the remote control.
The integrated garage door opener is compatible with devices that have units which operate in the frequency range of 280 to 390 MHz.
- Change the batteries in garage door remote control ⑤. This increases the likelihood that garage door remote control ⑤ will send a strong and precise signal to the integrated garage door opener in the rear-view mirror.
- When programming, hold remote control ⑤ at varying distances and angles from the button which you are programming. Try various angles at a distance of between 2 to 12 inches (5 to 30 cm) or at the same angle but at varying distances.
- if another remote control for the same garage door drive is available, repeat the same programming steps with this remote control. Before performing these steps, make sure that new batteries have been installed in garage door drive remote control ⑤.
- note that some remote controls only transmit for a limited amount of time (the indicator lamp on the remote control goes out). Press button ⑥ on remote control ⑤ before transmission ends.
- align the antenna cable of the garage door opener unit. This can improve signal reception/transmission.

Opening/closing the garage door

After it has been programmed, the integrated garage door opener performs the function of the garage door system remote control.

Please also read the operating instructions for the garage door system.

- ▶ Turn the SmartKey to position **2** in the ignition lock.
- ▶ Press one of the buttons ②, ③ or ④; whichever one is programmed to operate the garage door.
Garage door system with a fixed code: indicator lamp ① lights up green.
Garage door system with a rolling code: indicator lamp ① flashes green.

i The transmitter will transmit a signal for as long as the button is pressed. The transmission is halted after a maximum of ten seconds and indicator lamp ① flashes yellow. Press button ②, ③ or ④ again if necessary.

Clearing the memory of the integrated garage door opener on the rear-view mirror

- ▶ Turn the SmartKey to position **2** in the ignition lock.
 - ▶ Press buttons ② and ④.
The indicator lamp lights up yellow.
 - ▶ Press and hold buttons ② and ④ until the indicator lamp turns green.
- i** Make sure that you clear the memory of the integrated garage door opener before selling the vehicle.

Charge maintenance socket

The battery may drain if the vehicle is left stationary for long periods. In this case, Mercedes-Benz recommends attaching the trickle charger to the charge maintenance socket.

The charge maintenance socket is designed solely for connecting a trickle charger. A trickle charger can be obtained from an authorized Mercedes-Benz Center, for example.

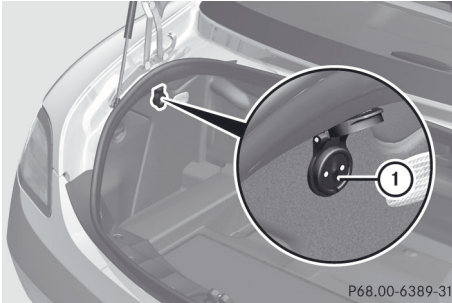

- ▶ Switch the ignition off.
- ▶ Open the trunk lid.
- ▶ Connect the cable provided in the trunk to the trickle charger.
- ▶ Connect the trickle charger to charge maintenance socket ①. Consult the manufacturer's operating instructions on how to do so.

i A trickle charger connected to charge maintenance socket ① only maintains the current charge level of the vehicle's electrical system battery. If the vehicle's electrical system battery is discharged, it needs to be charged with a battery charger. You will find further information on charging the battery on (▷ page 240).

Floor mat on the driver's side

WARNING

Whenever you are using a floormat, make sure there is enough clearance and that the floormat is securely fastened.

The floormat should always be securely fastened using the fastening equipment.

Before driving off, check that the floormat is securely in place and adjust it if necessary. A loose floormat could slip and hinder proper functioning of the pedals.

Do not place several floormats on top of each other as this may impair pedal movement.

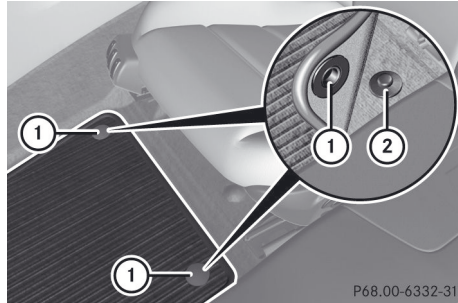

- ▶ Slide the seat backwards.
- ▶ **To install:** place the floormat in position.
- ▶ Press studs ① onto retainers ②.
- ▶ **To remove:** pull the floormat off retainers ②.
- ▶ Remove the floormat.

Useful information	218
Engine compartment	218
Maintenance	222
Care	223

Useful information

- i** This Operator's Manual describes all models and all standard and optional equipment of your vehicle available at the time of publication of the Operator's Manual. Country-specific differences are possible. Please note that your vehicle may not be equipped with all features described. This also applies to safety-related systems and functions.
- i** Please read the information on qualified specialist workshops (▷ page 21).

Engine compartment

Hood

Opening the hood

⚠ WARNING

Do not pull the release lever while the vehicle is in motion. Otherwise, the hood could be forced open by passing air flow.

This could cause the hood to come loose and injure you and/or others.

⚠ WARNING

Do not open the hood when the engine is overheated. You could be seriously injured. Observe the coolant temperature gauge to determine whether the engine may be overheated. If you see flames or smoke coming from the engine compartment, move away from the vehicle. Wait until the engine has cooled. If necessary, call the fire department.

⚠ WARNING

There is a risk of injury if the hood is open, even if the engine is not running.

Some engine components can become very hot.

To avoid the risk of burns, only touch those components described in the Operator's Manual and observe the relevant safety notes.

⚠ WARNING

To help prevent personal injury, stay clear of moving parts when the hood is open and the engine is running.

The radiator fan may continue to run for approximately 30 seconds or may even restart after the engine has been turned off. Stay clear of fan blades.

⚠ WARNING

The engine is equipped with a transistorized ignition system. Because of the high voltage, it is dangerous to touch any components (ignition coils, spark plug sockets, diagnostic socket) of the ignition system:

- with the engine running
- while starting the engine
- when the ignition is switched on and the engine is turned manually

- ▶ Make sure that the windshield wipers are switched off.

⚠ WARNING

The windshield wipers and wiper linkage could be set in motion.

When the hood is open, you or others could be injured by the wiper linkage.

Make sure that the windshield wipers are switched off. When using KEYLESS-GO, make sure that no ignition position is selected. All indicator lamps in the instrument cluster must be off.

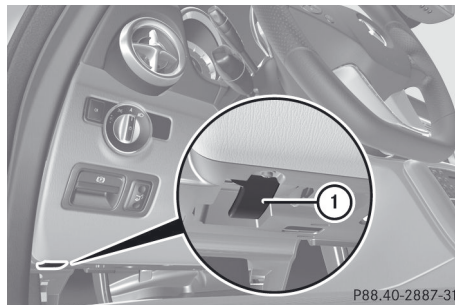

P88.40-2887-31

Hood release lever in driver's footwell

- ▶ Pull release lever ① for the hood.
The hood is released.

- ⚠ Make sure that the windshield wipers are not folded away from the windshield. You could otherwise damage the windshield wipers or the hood.

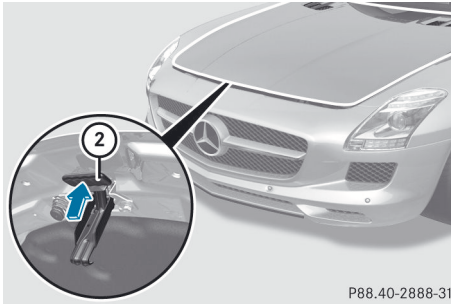

P88.40-2888-31

- ▶ Reach into the gap, pull hood catch handle ② up and lift the hood.

Closing the hood

WARNING

When closing the hood, use extreme caution not to catch hands or fingers. Be careful that you do not close the hood on anyone.

Make sure the hood is securely engaged before driving off. Do not continue driving if the hood can no longer engage after an accident, for example. The hood could otherwise come loose while the vehicle is in motion and injure you and/or others.

- ▶ Lower the hood and let it fall from a height of approximately 8 inches (20 cm).
- ▶ Check that the hood has engaged properly. If the hood can be raised slightly, it is not properly engaged. Open it again and close it with a little more force.

Engine oil

Notes on the oil level

Depending on the driving style, the vehicle consumes up to 0.9 US qts (0.8 l) of oil over a distance of 600 miles (1000 km). The oil consumption may be higher than this when the vehicle is new or if you frequently drive at high engine speeds.

Checking the oil level using the oil dipstick

When checking the oil level:

- park the vehicle on a level surface.
- the engine should be switched off for approximately five minutes if the engine is at normal operating temperature.

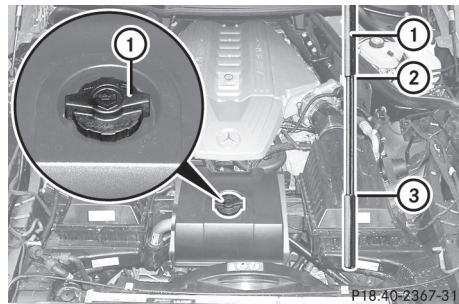

P18.40-2367-31

- ▶ Unscrew and remove oil filler cap ① with the integrated dipstick.
- ▶ Wipe the oil dipstick.
- ▶ Screw oil filler cap ① back all the way to the stop.
- ▶ Unscrew oil filler cap ① again and read the dipstick.
The oil level is correct if the level is between MIN mark ③ and MAX mark ②.
- ▶ Add oil if necessary.

Adding engine oil

Environmental note

When adding oil, take care not to spill any. If oil enters the soil or waterways, it is harmful to the environment.

! Use only engine oils and oil filters that have been approved for vehicles equipped with a service system. A list of the engine oils and oil filters tested and approved in accordance with the Mercedes-Benz Specifications for Service Products can be called up by visiting <http://www.mbusa.com> (USA only). More information about tested and approved engine oils and oil filters is available from any authorized Mercedes-Benz Center. Damage to the engine or exhaust system is caused by the following:

- using engine oils and oil filters which have not been specifically approved for the service system.
- replacing the engine oil or oil filter after the replacement interval required by the service system has elapsed
- using engine oil additives.

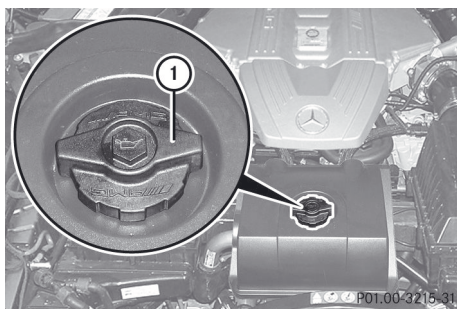

- ▶ Unscrew and remove oil filler cap ① with the integrated dipstick.
- ▶ Add the amount of oil required.

! Do not add too much oil. If the oil level is above the "max" mark on the dipstick, too much oil has been added. This can lead to damage to the engine or the catalytic converter. Have excess oil siphoned off.

- ▶ Replace cap ① on the filler neck and tighten clockwise. Ensure that the cap locks into place securely.

You will find further information about engine oil in the "Technical data" section (> page 282).

Checking and adding other service products

Checking the coolant level

WARNING

In order to avoid any potentially serious burns:

- use extreme caution when opening the hood if there are any signs of steam or coolant leaking from the cooling system, or if the coolant temperature display indicates that the coolant is overheated.
- do not remove the pressure cap on the coolant reservoir if the coolant temperature is above 158 °F (70 °C). Allow the engine to cool down before removing the cap. The coolant reservoir contains hot fluid and is under pressure.
- using a rag, slowly turn the cap approximately 1/2 turn to relieve excess pressure. If opened immediately, scalding hot fluid and steam will be blown out under pressure.
- do not spill antifreeze on hot engine parts. Antifreeze contains ethylene glycol which may burn if it comes into contact with hot engine parts.

Only check the coolant level when the vehicle is on a level surface and the engine has cooled down.

- ▶ Set the Start/Stop button to key position 2.
- ▶ Check the coolant temperature display in the "AMG" menu (> page 160). The coolant temperature must be below 158 °F (70 °C).

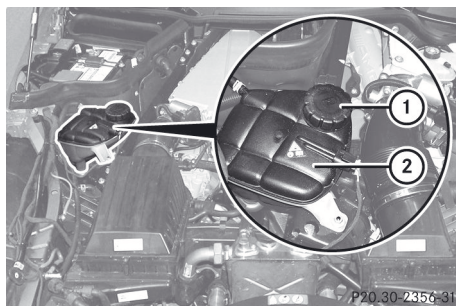

- ▶ Slowly turn cap ① half a turn counter-clockwise and allow excess pressure to escape.
- ▶ Turn cap ① further counter-clockwise and remove it.
If the coolant is at the level of the marker bar in the filler neck when cold, there is enough coolant in coolant expansion tank ②.
If the coolant is approximately 0.6 in (1.5 cm) above the marker bar in the filler neck when warm, there is enough coolant in coolant expansion tank ②.
- ▶ If necessary, add coolant that has been tested and approved by Mercedes-Benz.
- ▶ Replace cap ① and turn it clockwise as far as it will go.

You will find further information about coolant in the "Technical data" section (▷ page 283).

Windshield washer system and headlamp cleaning system

The washer fluid reservoir is used for both the windshield washer system and the headlamp cleaning system.

- ❗ Vehicle components and their service products must match. You should, therefore, only use products that have been tested and approved by Mercedes-Benz. Information on tested and approved products can be obtained at any authorized Mercedes-Benz Center or on the Internet at <http://www.mbusa.com> (USA only).

⚠ WARNING

Washer solvent/antifreeze is highly flammable. Do not spill washer solvent/antifreeze on hot engine parts, because it may ignite and burn. You could be seriously burned.

- ❗ At temperatures below freezing: always fill the washer fluid reservoir with a mix of water and windshield washer concentrate (e.g. MB WinterFit). There is otherwise a risk of damaging the windshield washer system/headlamp cleaning system.
- ❗ Only use washer fluid concentrate which is suitable for plastic lenses. Unsuitable washer fluid concentrate could damage the plastic lenses of the headlamps.
- ❗ Do not add distilled or de-ionized water to the washer fluid container. Otherwise, the level sensor may be damaged.
- ❗ Add windshield washer concentrate, e.g. MB SummerFit, to the washer fluid all year round.

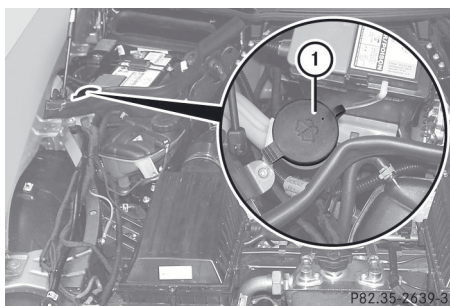

- ▶ Mix the windshield washer fluid in a container beforehand.
- ▶ **At temperatures above freezing:** fill the washer fluid reservoir with a mix of water and windshield washer concentrate (e.g. MB SummerFit).
- ▶ **At temperatures below freezing:** fill the washer fluid reservoir with a mix of water and windshield washer concentrate (e.g. MB WinterFit). Adapt the mixing ratio to the

outside temperature. For information on the mixing ratio (▷ page 284).

- ▶ **To open:** pull cap ① upwards by the tab.
- ▶ Add the premixed washer fluid.
- ▶ **To close:** press cap ① onto the filler neck until it engages.

Maintenance

Service interval display

Service messages

Information on the type of service and service intervals (see separate Maintenance Booklet).

You can obtain further information from an authorized Mercedes-Benz Center or at <http://www.mbusa.com> (USA only).

The service interval message informs you of the next service due date.

If a service due date has been exceeded, you also hear a warning tone.

The multifunction display shows a service message for several seconds, e.g.:

Next service A in .. days

Service A due

Service A overdue by .. days

The letter indicates which service is due. **A** stands for a minor service and **B** for a major service. A number or another letter may be displayed after the letter. This figure indicates any necessary additional maintenance work to be performed.

You can obtain further information from an authorized Mercedes-Benz Center.

The service interval display does not take into account any periods of time during which the battery is disconnected.

Maintaining the time-dependent service schedule:



- ▶ Note down the service due date displayed in the multifunction display before disconnecting the battery.

or





- ▶ Subtract the battery disconnection periods from the service date shown on the display after reconnecting the battery.

i The service interval display does not provide any information regarding the engine's oil level. Observe the notes on the engine oil level (▷ page 219).

Hiding a service message

- ▶ Press the  or  button on the steering wheel.

Displaying service messages

- ▶ Switch on the ignition.
- ▶ Press the  or  button on the steering wheel to select the **Serv.** menu.
- ▶ Press the  or  button to select the **ASSYST PLUS** submenu and confirm with .

The service due date appears in the multifunction display.

Please bear the following in mind

Resetting the service interval display

A qualified specialist workshop, e.g. an authorized Mercedes-Benz Center, will reset the service interval display after the necessary service work has been carried out.

Further information, on maintenance for example, can be obtained at an authorized Mercedes-Benz Center or directly from Mercedes-Benz.

- !** If the service interval display has been reset unintentionally, have the setting corrected at a Mercedes-Benz Center.

Have service work carried out as described in the Maintenance Booklet. This may otherwise lead to increased wear and damage to the major assemblies or the vehicle.

Driving abroad

An extensive Mercedes-Benz Service network is also available in other countries. You can obtain further information from any authorized Mercedes-Benz Center.

Care

Notes on care

Regular care of your vehicle is a condition for retaining the quality in the long term.

Use care products and cleaning agents recommended and approved by Mercedes-Benz.

WARNING

Many cleaning products can be hazardous. Some are poisonous, others are flammable. Always follow the instructions on the particular container. Always open your vehicle's doors or windows when cleaning the inside.

Never use fluids or solvents that are not designed for cleaning your vehicle.

Always lock away cleaning products and keep them out of reach of children.

! For cleaning your vehicle, do not use any of the following:

- dry, rough or hard cloths
- abrasive cleaning agents
- solvents
- cleaning agents containing solvents

Do not scrub.

Do not touch the surfaces or protective films with hard objects, e.g. a ring or ice scraper. You could otherwise scratch or damage the surfaces and protective film.

Environmental note

Dispose of empty packaging and cleaning cloths in an environmentally responsible manner.

! Do not park the vehicle for an extended period right after cleaning it, particularly after having cleaned the wheels with wheel cleaner. Wheel cleaners could cause increased corrosion of the brake discs and brake pads/linings. For this reason, you should drive for a few minutes after cleaning. Braking heats the brake discs and brake pads, thus drying them. The vehicle can then be parked.

Exterior care

Automatic car wash

WARNING

Braking efficiency is reduced after washing the vehicle. This could cause an accident.

After the vehicle has been washed, brake firmly while paying attention to the traffic conditions. This will warm up the brake discs, thereby drying them more quickly. After washing the vehicle, drive particularly carefully until the brakes are dry and braking power has been fully restored.

You can wash the vehicle in an automatic car wash from the very start.

If the vehicle is very dirty, pre-wash it before cleaning it in an automatic car wash.

! Never clean your vehicle in a Touchless Automatic Car Wash as these use special cleaning agents. These cleaning agents can damage the paintwork or plastic parts.

! When washing your vehicle in a tow-through car wash, use the SmartKey instead of the Start/Stop button.

Start the engine using the SmartKey.. Move the transmission to **N** with the E-SELECT lever. Use the SmartKey to switch the engine off again and then turn the

SmartKey to position **2**. Make sure that you then leave the SmartKey in position **2**. You may otherwise damage the vehicle, the transmission or the car wash.

Check the transmission position in the instrument cluster.

- ❗ Use the E-SELECT lever to shift the transmission to **N** before switching the engine off. If you open the driver's or front-passenger door, the transmission remains in this position for up to 30 minutes if the SmartKey is in the ignition, even if the engine is switched off. If you do not shift the transmission to **N** using the E-SELECT lever beforehand, it shifts automatically to parking position **P** and locks the wheels if the driver's or front-passenger door is opened and the engine is switched off. This may damage the vehicle, the transmission or the car wash.

Observe the information on maneuvering (▷ page 129).

- ❗ Before driving into an automatic car wash, make sure that it is suitable for the dimensions of the vehicle. In particular, make sure that:

- there is enough ground clearance between the vehicle underbody and the guide rails of the automatic car wash.
- the clearance width of the automatic car wash is sufficient, particularly the width of the guide rails.
- you enter the automatic car wash straight and in the center of the guide rails in order to avoid damaging the tires or wheel rims.

Fold in the exterior mirrors before the vehicle is washed. The exterior mirrors could otherwise be damaged.

- ❗ Make sure that:

- the side windows are fully closed.
- the ventilation/heating is switched off (the OFF button has been pressed/the airflow control is set to position **0**).
- that the windshield wiper switch is in position **0**.

Otherwise, the vehicle might be damaged.

- ❗ In portal car washes, the windshield wipers may be moved up the windshield by the cleaning brushes when the ignition is switched off.

Set the Start/Stop button to key position **2** to reset the windshield wipers to their original position.

- ❗ Vehicles with a matte finish:

Do not use wash programs with a hot wax treatment under any circumstances.

After using an automatic car wash, wipe off wax and drying agents from the windshield and the wiper blades. This will prevent smears and reduce wiping noises caused by residue on the windshield.

Power washers

WARNING

Using power washers with circular-jet nozzles (dirt grinders) may cause damage to the vehicle, in particular to the tires.

Using damaged tires results in an increased risk of accident. A sudden loss of tire pressure while you are driving may cause you to lose control of your vehicle, cause an accident and injure yourself and others.

- ❗ Maintain a minimum distance of 11.8 in (30 cm) between the vehicle and the power washer nozzle. Information about the correct distance is available from the equipment manufacturer.

Move the power washer nozzle around when cleaning your vehicle.

Do not aim directly at any of the following:

- tires
- door gaps, roof gaps, joints, etc.
- electrical components
- battery
- connectors
- lights
- seals
- trim elements
- ventilation slots

Damaged seals or electrical components can lead to leaks or failures.

Cleaning the wheels

! Do not use acidic wheel cleaning products to remove brake dust. This could damage wheel bolts and brake components.

! Do not park the vehicle for an extended period right after cleaning it, particularly after having cleaned the wheels with wheel cleaner. Wheel cleaners could cause increased corrosion of the brake discs and brake pads/linings. For this reason, you should drive for a few minutes after cleaning. Braking heats the brake discs and brake pads, thus drying them. The vehicle can then be parked.

Cleaning the paintwork

Scratches, corrosive deposits, areas affected by corrosion and damage caused by inadequate care cannot always be completely repaired. In such cases, visit a qualified specialist workshop, e.g. an authorized Mercedes-Benz Center.

- ▶ Remove impurities immediately, where possible, whilst avoiding rubbing too hard.
- ▶ Soak insect remains with insect remover and rinse off the treated areas afterwards.
- ▶ Soak bird droppings with water and rinse off the treated areas afterwards.
- ▶ Remove coolant, brake fluid, tree resin, oils, fuels and greases by rubbing gently

with a cloth soaked in petroleum ether or lighter fluid.

- ▶ Use tar remover to remove tar stains.
- ▶ Use silicone remover to remove wax.

! Do not affix:

- stickers
- films
- magnetic plates or similar items

to painted surfaces. You could otherwise damage the paintwork.

If water no longer forms "beads" on the paint surface, use the paint care products recommended and approved by Mercedes-Benz. This is the case approximately every three to five months, depending on the climate conditions and the care product used. If dirt has penetrated the paint surface or the paint has become dull, the paint cleaner recommended and approved by Mercedes-Benz should be used.

Do not use these care products in the sun or on the hood while the hood is hot.

- ▶ Use a suitable touch-up stick, e.g. MB Touch-Up Stick, to correct smaller areas of paint damage quickly and provisionally.

Matte finish care

If your vehicle has a clear matte finish, observe the following instructions in order to avoid damage to the paintwork due to incorrect care.

These notes also apply to light alloy wheels with a clear matte finish.

! Never polish the vehicle or the light alloy wheels. Polishing causes the finish to shine.

! The following may cause the paint to become shiny and thus reduce the matte effect:

- Vigorous rubbing with unsuitable materials.
- Frequent use of car washes.
- Washing the vehicle in direct sunlight.

! Never use paint cleaner, buffing or polishing products such as gloss preserver (wax). These products are only suitable for high-gloss surfaces. Their use on vehicles with matte finish leads to considerable surface damage (shiny, spotted areas).

If wax comes into contact with the painted surface by accident, remove it immediately with commercially available petroleum ether. Do so carefully and do not apply too much pressure to the painted surface.

Ensure that no resinous, greasy or oily substances come into contact with the paint, as these can leave a residue. If such substances do come into contact with the painted surface accidentally, remove these immediately with commercially available petroleum ether. Do so carefully and do not apply too much pressure to the painted surface.

Tar stains or marks on the painted surface can be removed with a commercially available tar remover. Do so carefully and do not apply too much pressure to the painted surface.

Always have paintwork repairs carried out at a qualified specialist workshop, e.g. an authorized Mercedes-Benz Center.

! Do not use wash programs with a hot wax treatment under any circumstances.

i The vehicle should preferably be washed by hand using a soft sponge, car shampoo and plenty of water.

i Use only insect remover and car shampoo from the range of recommended and approved Mercedes-Benz care products.

Cleaning the Roadster soft top

► **Light soiling:** you can clean the soft top while it is dry or rinse it with clear water.

► **Normal to heavy soiling:** clean the soft top with a brush and clear water. Clean stains and other dirt with a brush and soft top cleaning agents that have been recommended and approved by Mercedes-Benz. Always brush from front to back, following the grain of the fabric.

! Never use any of the following to clean the soft top:

- gasoline
- thinner
- tar or stain remover
- other organic solvents

! Remove bird droppings immediately as they are corrosive and, therefore, can make the soft-top fabric leak. Do not use high-pressure cleaning equipment to clean the vehicle. Do not use sharp-edged equipment to remove ice and snow.

Frequent cleaning reduces the soft top's resistance to dirt.

To restore this resistance to dirt, clean the soft top using soft top cleaning agents that have been recommended and approved by Mercedes-Benz.

Incorrect cleaning and care, as well as aging, can cause the soft-top seams to leak. Have the soft-top seams sealed at a qualified specialist workshop, e.g. at an authorized Mercedes-Benz Center.

i Cover the soft top appropriately if you plan to leave the vehicle outside for a long period of time.

Cleaning the windows

WARNING

Switch the windshield wipers off before cleaning the windshield or wiper blades. Press the Start/Stop button repeatedly until all

indicator lamps in the instrument cluster have gone off. The windshield wipers could otherwise move and injure you.

- ❗ Only fold the windshield wipers away from the windshield when vertical. Otherwise, you will damage the hood.
- ▶ Clean the inside and outside of the windows with a damp cloth and a cleaning agent that is recommended and approved by Mercedes-Benz.
- ❗ Do not use dry cloths, abrasive products, solvents or cleaning agents containing solvents to clean the inside of the windows. Do not use hard objects to clean the insides of the windows, e.g. an ice scraper or ring. There is otherwise a risk of damaging the windows.
- ❗ Clean the water drainage channels of the windshield and the rear window at regular intervals. Deposits such as leaves, petals and pollen may under certain circumstances prevent water from draining away. This can lead to corrosion damage and damage to electronic components.

Cleaning the wiper blades

WARNING

Switch the windshield wipers off before cleaning the windshield or wiper blades. Press the Start/Stop button repeatedly until all indicator lamps in the instrument cluster have gone off. The windshield wipers could otherwise move and injure you.

- ❗ Only fold the windshield wipers away from the windshield when vertical. Otherwise, you will damage the hood.
- ❗ Do not pull the wiper blade. Otherwise, the wiper blade could be damaged.
- ❗ Do not clean wiper blades too often and do not rub them too hard. Otherwise, the graphite coating could be damaged. This could cause wiper noise.

- ▶ Switch off the engine.
- ▶ Take your foot off the brake pedal.
- ▶ Set the windshield wipers to the  position on the combination switch.
- ▶ Press the Start/Stop button repeatedly until the windshield wipers start.
- ▶ When the wiper arms have reached a vertical position: press the Start/Stop button.
- ▶ Fold the wiper arm away from the windshield until it engages.
- ▶ Set the wiper blade at right angles to the wiper arm.
- ▶ Carefully clean the wiper blades with a damp cloth.
- ▶ Fold the windshield wiper arms back again before switching on the ignition.
- ❗ Hold the wiper arm securely when folding back. The windshield could be damaged if the wiper arm smacks against it suddenly.

Cleaning the exterior lighting

- ▶ Clean the plastic lenses of the exterior lighting using a wet sponge and a mild cleaning agent, e.g. Mercedes-Benz car shampoo or cleaning cloths.
- ❗ Only use cleaning agents or cleaning cloths which are suitable for plastic light lenses. Unsuitable cleaning agents or cleaning cloths could scratch or damage the plastic light lenses.

Cleaning the sensors

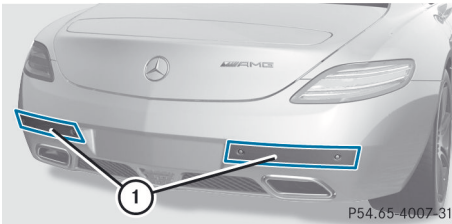
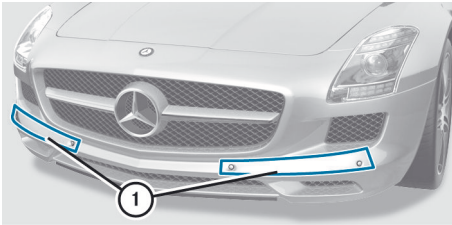

- ▶ Clean sensors ① of the driving systems with water, car shampoo and a soft cloth.

❗ When cleaning the sensors with a power washer, maintain a distance between the vehicle and the nozzle of the power washer of at least 11.8 in (30 cm). Information about the correct distance is available from the equipment manufacturer.

Cleaning the rear view camera

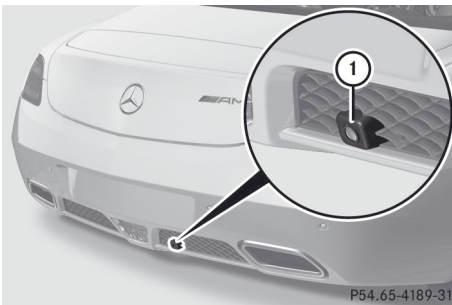

- ▶ Use clear water and a soft cloth to clean camera lens ①.

❗ Do not clean the camera lens and the area around the rear view camera with a power washer.

Cleaning the exhaust pipes

Impurities combined with the effects of road grit and corrosive environmental factors may cause flash rust to form on the surface. You can restore the original shine of the exhaust tail pipe by cleaning it regularly, especially in winter and after washing.

- ❗ Do not clean the exhaust tail pipes with alkaline-based cleaning agents, such as wheel cleaner.
- ▶ Clean the exhaust tail pipes with a chrome care product tested and approved by Mercedes-Benz.

Interior care

Cleaning the display

❗ For cleaning, do not use any of the following:

- alcohol-based thinner or gasoline
- abrasive cleaning agents
- commercially-available household cleaning agents

These may damage the display surface. Do not put pressure on the display surface when cleaning. This could lead to irreparable damage to the display.

- ▶ Before cleaning the display, make sure that it is switched off and has cooled down.
- ▶ Clean the display surface using a commercially available microfiber cloth and TFT/LCD display cleaner.
- ▶ Dry the display surface using a dry microfiber cloth.

Cleaning the plastic trim

⚠ WARNING

When cleaning the steering wheel boss and dashboard, do not use cockpit sprays or cleaning agents containing solvents. Cleaning agents containing solvents cause the surface to become porous, and as a result, plastic

parts may break away and be thrown around the interior when an air bag is deployed, which may result in severe injuries.

! Do not affix the following to plastic surfaces:

- stickers
- films
- scented oil bottles or similar items

You can otherwise damage the plastic.

! Do not allow cosmetics, insect repellent or sunscreen to come into contact with the plastic trim. This maintains the high-quality look of the surfaces.

- ▶ Wipe the plastic trim with a damp, lint-free cloth, e.g. a microfiber cloth.
- ▶ **Heavy soiling:** use car care and cleaning products recommended and approved by Mercedes-Benz. The surface may change color temporarily. Wait until the surface is dry again.

Cleaning genuine wood and trim elements

! Do not use solvent-based cleaning agents such as tar remover, wheel cleaners, polishes or waxes. There is otherwise a risk of damaging the surface.

! Do not use chrome polish on trim pieces. The trim pieces have a chrome look but are mostly made of anodized aluminum and can lose their shine if chrome polish is used. Use a damp, lint-free cloth instead when cleaning the trim pieces.

If the chrome-plated trim pieces are very dirty, you can use a chrome polish. If you are unsure as to whether the trim pieces are chrome-plated or not, consult an authorized Mercedes-Benz Center.

- ▶ Wipe the wooden trim and trim pieces with a damp, lint-free cloth, e.g. a microfiber cloth.
- ▶ **Heavy soiling:** use car care and cleaning products recommended and approved by Mercedes-Benz.

Cleaning the seat covers

! Do not use microfiber cloths to clean genuine leather, artificial leather or Alcantara® covers. If used often, these can damage the cover.

! Clean genuine leather covers with a damp cloth, then wipe the covers down with a dry cloth. Make sure that the leather does not become soaked. Only use leather care agents that have been tested and approved by Mercedes-Benz. You can obtain these from any authorized Mercedes-Benz Center.

i Note that regular care is essential to ensure that the appearance and comfort of the covers is retained over time.

Cleaning the seat belts

! Do not clean the seat belts using chemical cleaning agents. Do not dry the seat belts by warming them above 176 °F (80 °C) or placing them in direct sunlight.

⚠ WARNING

Do not bleach or dye seat belts as this may severely weaken them. In a crash, they may not be able to provide adequate protection.

- ▶ Use clean, lukewarm water and soap solution.

Useful information	232
Where will I find...?	232
Flat tire	233
Battery	240
Jump-starting	243
Towing and tow-starting	244
Fuses	247

Useful information

- i** This Operator's Manual describes all models and all standard and optional equipment of your vehicle available at the time of publication of the Operator's Manual. Country-specific differences are possible. Please note that your vehicle may not be equipped with all features described. This also applies to safety-related systems and functions.
- i** Please read the information on qualified specialist workshops (▷ page 21).

Where will I find...?

First-aid kit

The first-aid kit is located in the left-hand stowage compartment in the trunk.

- ▶ Open the trunk lid.

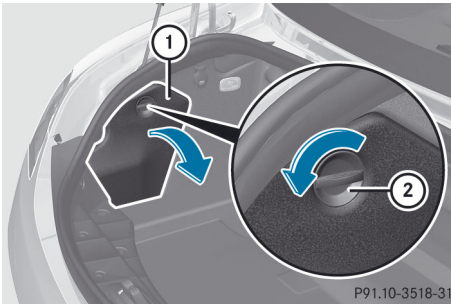

- ▶ Turn fastener ② in the direction of the arrow.
 - ▶ Open stowage compartment ①.
 - ▶ Open the Velcro fastener and remove the first aid kit.
- i** Check the expiration date on the first-aid kit at least once a year. Replace the contents if necessary, and replace missing contents.

Vehicle tool kit

Wheel-change tool kit and jack¹⁶

The wheel-change tool kit and the jack are located in the left-hand stowage space in the trunk.

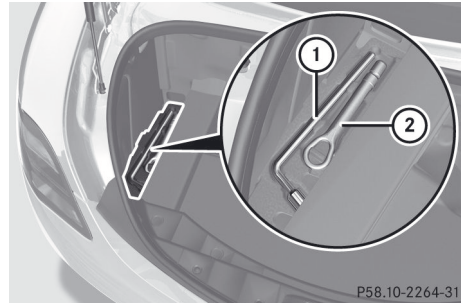

Left-hand stowage space in trunk floor

- ① Lug wrench
 - ② Towing eye
- ▶ Pull the loop on the floor covering and fold the floor covering forward.
 - ▶ Take out the jack and lug wrench ① underneath it.

TIREFIT kit, wheel chock, alignment bolt and gloves

The TIREFIT kit, wheel chock, alignment bolt and gloves are located in the left-hand stowage compartment in the trunk.

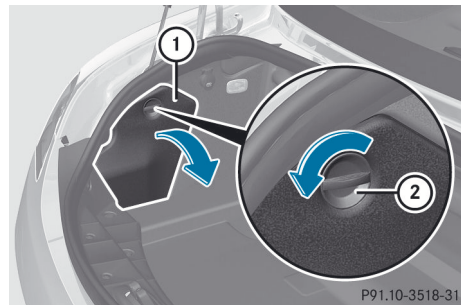

Left-hand stowage compartment in the trunk

¹⁶ Not included in the scope of delivery in all countries.

- ▶ Remove the jack from the left-hand stowage space in the trunk to allow the stowage compartment to be opened.
- ▶ Turn fastener ② in the direction of the arrow.
- ▶ Open stowage compartment ①.
- ▶ Remove the TIREFIT kit, wheel chock, alignment bolt and gloves.

Flat tire

Preparing the vehicle

Your vehicle is equipped with a TIREFIT kit.

- ▶ Stop the vehicle on solid, non-slippery and level ground, as far away as possible from traffic.
- ▶ Switch on the hazard warning lamps.
- ▶ Apply the electric parking brake manually (> page 130).
- ▶ Bring the front wheels into the straight-ahead position.
- ▶ Shift the transmission to **P** using the button on the center console.
- ▶ Switch off the engine.
- ▶ Remove the SmartKey from the ignition lock.
- ▶ All occupants must get out of the vehicle. Make sure that they are not endangered as they do so.
- ▶ Make sure that no one is near the danger area while a wheel is being changed. Anyone who is not directly assisting in the wheel change should, for example, stand behind the barrier.
- ▶ Get out of the vehicle. Pay attention to traffic conditions when doing so.
- ▶ Close the driver's door.

TIREFIT kit

Using the TIREFIT kit

WARNING

TIREFIT is a limited repair device. TIREFIT cannot be used for cuts or punctures larger than approximately 0.16 in (4 mm) and tire damage caused by driving with extremely low tire inflation pressure, or on a flat tire, or a damaged wheel.

Do not drive the vehicle under such circumstances.

Contact the nearest authorized Mercedes-Benz Center for assistance or call Roadside Assistance.

WARNING

Take care not to allow the contents of TIREFIT to come in contact with hair, eyes or clothing. TIREFIT is harmful if inhaled, swallowed or absorbed through the skin - causes skin, eye and respiratory irritation.

Any contact with eyes or skin should be flushed immediately with plenty of water.

If clothing comes in contact with TIREFIT, change clothing as soon as possible.

In case of allergic reaction or rash, consult a physician immediately.

WARNING

Keep TIREFIT away from children. If swallowed, rinse mouth immediately with plenty of water and drink plenty of water.

Do not induce vomiting.

Consult a doctor immediately.

Keep away from open flame or heat source.

You can use the TIREFIT kit to seal small punctures, particularly those in the tire tread. You can use TIREFIT at outside temperatures down to -40 °C.

- ▶ Do not remove any foreign objects which have penetrated the tire, e.g. screws or nails.
- ▶ Take the TIREFIT kit out of the trunk (▷ page 232).

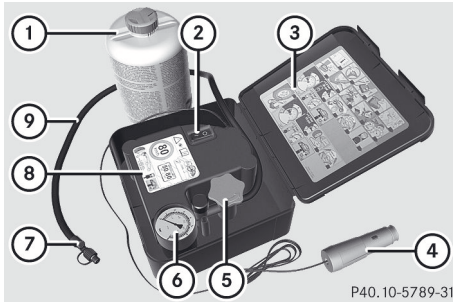

- ▶ Open the TIREFIT kit and remove "max. 80 km/h" sticker (8).
- ▶ Affix sticker (8) within the driver's field of vision.
- i** If TIREFIT leaks out, allow it to dry. It can then be removed like a layer of film. If you get TIREFIT on your clothing, have it cleaned as soon as possible with perchloroethylene.

Comply with the manufacturer's safety instructions on the tire inflation compressor label and on the tire sealant bottle.

- i** You will also find operating instructions (3) in the lid of the TIREFIT kit.
- ▶ Pull the cable and filler hose (9) out of the housing.

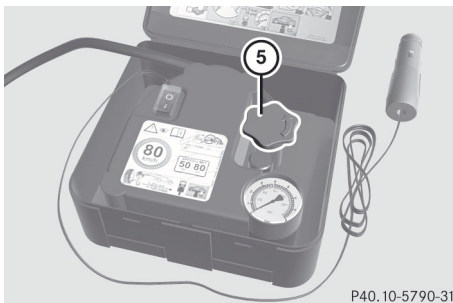

- ▶ Unscrew flanged cap (5).

- ▶ Unscrew the cap from tire sealant bottle (1). Make sure that the aluminum film is not damaged when doing so.

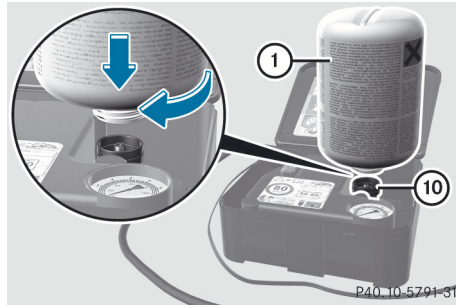

- ▶ Screw tire sealant bottle (1) clockwise tightly onto flange seal (10). This pierces the aluminum film.
- ▶ Remove the cap from the valve on the faulty tire.
- ▶ Make sure that pressure release screw (7) is closed.
- ▶ Remove the dust protection cap from filler hose (9).

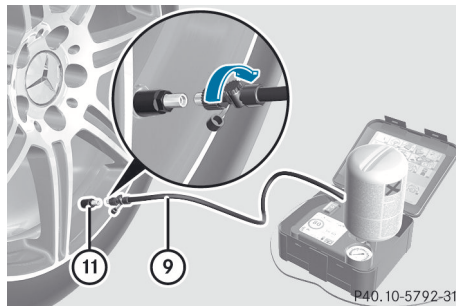

- ▶ Screw the end of filler hose (9) onto tire valve (11).
- ▶ Make sure that on/off switch (2) on the tire inflation compressor is set to 0.
- ▶ Insert connector (4) into the 12 V cigarette lighter socket (▷ page 203).
- ▶ Select key position 2 with the Start/Stop button (▷ page 115).
- i** The battery discharges during tire inflation compressor usage. For this

reason, you should start the engine unless you are inflating the tire in an enclosed space.

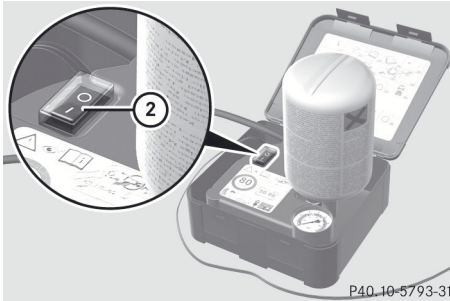

- ▶ Press on/off switch ② on the tire inflation compressor to I.
The tire inflation compressor is switched on. The tire is inflated.

i First, TIREFIT is pumped into the tire. The pressure can briefly rise to approximately 500kPa (5bar/73psi).

Do not switch off the tire inflation compressor during this phase.

- ▶ Let the tire inflation compressor run for a maximum of ten minutes. Afterwards, a tire pressure of at least 180 kPa (1.8 bar/26 psi) must be achieved.
Switch the tire inflation compressor off briefly to read the correct value from pressure gauge ⑥.

! Do not operate the tire inflation compressor for longer than ten minutes at a time without a break. It may otherwise overheat.

The tire inflation compressor can be operated again once it has cooled down.

Tire pressure of at least 180 kPa (1.8 bar/26 psi) is not reached

⚠ WARNING

If after five minutes a pressure of 180 kPa (1.8 bar/26 psi) cannot be achieved, the tire is too badly damaged to be repaired reliably using TIREFIT.

In this case TIREFIT cannot seal the tire properly.

Do not drive any further.

Contact the nearest authorized Mercedes-Benz Center for assistance or call Roadside Assistance.

If, after five minutes, a pressure of 180 kPa (1.8 bar/26 psi) has not been achieved:

- ▶ Switch off the tire inflation compressor, remove it and drive the vehicle approximately 30 ft (10 m) forward or back. This distributes the TIREFIT more evenly.
- ▶ Leave tire sealant bottle ① attached to the flange.
- ▶ Pump up the tire again.

Tire pressure of 180 kPa (1.8 bar/26 psi) is reached

If the tire pressure is at least 180 kPa (1.8 bar/26 psi):

- ▶ Press on/off switch ② on the tire inflation compressor to 0.
The tire inflation compressor is switched off.
- ▶ Remove connector ④ from the 12 V socket.
- ▶ Remove filler hose ⑨ from tire valve ⑪ and re-install the dust protection cap. Screw the valve cap onto the valve again.
Leave tire sealant bottle ① attached to flange ⑩.
- ▶ Stow the TIREFIT kit in a safe and accessible place in the vehicle.
- ▶ **Pull away immediately.**

! After use, excess TIREFIT may run out of the filler hose. This could cause stains.

⚠ WARNING

Do not exceed a vehicle speed of 50 mph (80 km/h). A TIREFIT repair is not designed to operate at higher speeds.

The sticker must be attached on the instrument cluster where it will be easily seen by the driver.

Vehicle handling characteristics of a TIREFIT repaired tire may change. Adapt your driving accordingly.

- ▶ Stop after driving for approximately ten minutes and check the tire pressure with the tire inflation compressor.

- ❗ On tires that are equipped with a tire pressure sensor (tire pressure monitor), the use of sealant can lead to error messages and incorrect displays. Therefore, use pressure gauge ⑥ in the TIREFIT kit to check and correct the tire pressure.

WARNING

If tire inflation pressure has fallen below 130 kPa (1.3 bar/26 psi) do not continue to drive the vehicle.

Park your vehicle safely away from the roadway and contact the nearest authorized Mercedes-Benz Center or Roadside Assistance.

Have the damaged tire replaced.

- ▶ Correct the tire pressure if it is at least 130 kPa (1.3 bar/20 psi) (for the required values see the Tire and Loading Information placard on the driver's side B-pillar or the tire pressure table inside the fuel filler flap).

To increase the tire pressure: switch on the tire inflation compressor.

To reduce the tire pressure: open release screw ⑦.

- ❗ The manufacturer does not guarantee that all tire damage can be repaired using the TIREFIT kit, particularly in the case of cuts and punctures with a diameter of more than four millimeters or on the sidewall. The manufacturer is not responsible for damage caused by inappropriate use of the TIREFIT kit.

- ▶ Drive to the nearest workshop and have the tire changed there.
- ▶ Have the tire sealant bottle replaced as soon as possible at a qualified specialist workshop, e.g. at an authorized Mercedes-Benz Center.

Environmental note

Have the used tire sealant bottle disposed of professionally, e.g. at an authorized Mercedes-Benz Center.

- ▶ Have the TIREFIT kit replaced every four years at a qualified specialist workshop, e.g. an authorized Mercedes-Benz Center.

Changing a wheel and mounting the spare wheel

Preparing the vehicle

- ▶ Prepare the vehicle as described (▷ page 233).
- ▶ Bring the wheels into the straight-ahead position.
- ▶ Take the following objects from the left-hand stowage compartment and the left-hand stowage space in the trunk:
 - the lug wrench
 - the folding wheel chock
 - the jack
 - the alignment bolt
- ▶ Secure the vehicle to prevent it from rolling away.

Securing the vehicle to prevent it from rolling away

WARNING

Only jack up the vehicle on level ground or on slight inclines/declines. The vehicle could otherwise fall off the jack and injure you or others.

If your vehicle is equipped with a wheel chock, it can be found in the vehicle tool kit (▷ page 232).

The folding wheel chock is an additional securing measure to prevent the vehicle from rolling away, for example when changing a wheel.

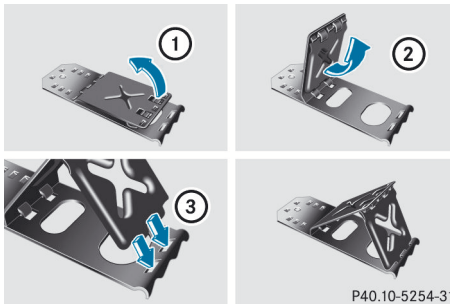

- ▶ Fold both plates upwards ①.
- ▶ Fold out lower plate ②.
- ▶ Guide the lugs on the lower plate fully into the openings in base plate ③.

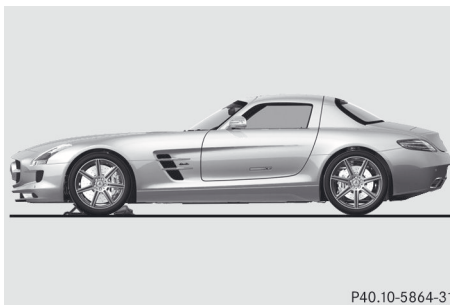

Securing the vehicle on level ground

- ▶ **On level ground:** place chocks or other suitable items under the front and rear of the wheel that is diagonally opposite the wheel you wish to change.

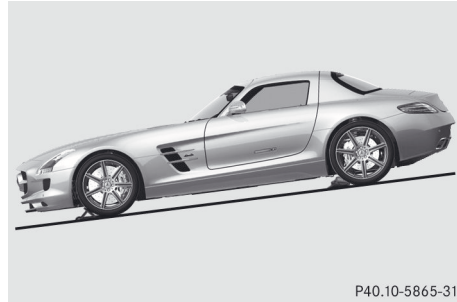

Securing the vehicle on slight downhill gradients

- ▶ **On downhill gradients:** place chocks or other suitable items in front of the wheels of the front and rear axle.

Raising the vehicle

WARNING

When jacking up the vehicle, only use the jack which has been specifically approved by Mercedes-Benz for your vehicle.

The jack is designed exclusively for jacking up the vehicle at the jacking points built into both sides of the vehicle. The jack saddle must be placed centrally under the jacking point. The jack must always be vertical when in use, especially on inclines or declines.

The jack is intended only for lifting the vehicle briefly for wheel changes. It is not suited for performing maintenance work under the vehicle. To help avoid personal injury, use the jack only to lift the vehicle during a wheel change.

Never get beneath the vehicle while it is supported by the jack. Keep hands and feet away from the area under the lifted vehicle. Always lower the vehicle onto sufficient capacity jackstands before working under the vehicle.

Always firmly engage the parking brake and block the wheels with wheel chocks or other sizable objects before raising the vehicle with the jack. Do not disengage the parking brake while the vehicle is raised.

Make sure that the ground on which the vehicle is standing and where you place the jack is solid, level and not slippery. If necessary, use a large underlay. On slippery surfaces, such as tiled floors, you should use a non-slip underlay, for example a rubber mat.

Do not use wooden blocks or similar objects as a jack underlay. Otherwise, the jack may not be able to achieve its load-bearing capacity if it is not at its full height.

Never start the engine when the vehicle is raised.

Also observe the notes on the jack.

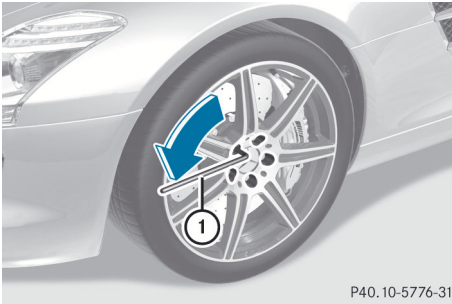

- ▶ Using lug wrench ①, loosen the bolts on the wheel you wish to change by about one full turn. Do not unscrew the wheel bolts completely.

The mounting for the jack is centered between the front and rear wheel housings (arrow).

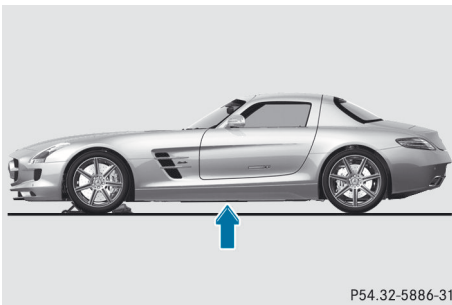

WARNING

The jack is designed exclusively for jacking up the vehicle at the jacking points. The jack

saddle must be placed centrally under the jacking point.

If you do not position the jack correctly in the jacking point, the vehicle can fall off the jack and seriously or fatally injure you or others.

- ❗ The jack is designed exclusively for jacking up the vehicle at the jacking points. Otherwise, your vehicle could be damaged.

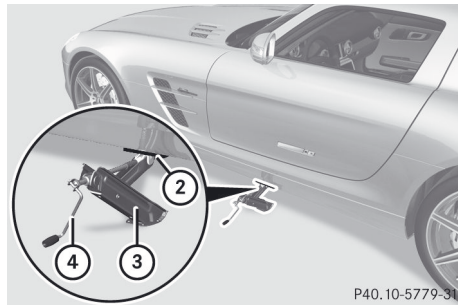

- ▶ Position jack ③ at jacking point ②.

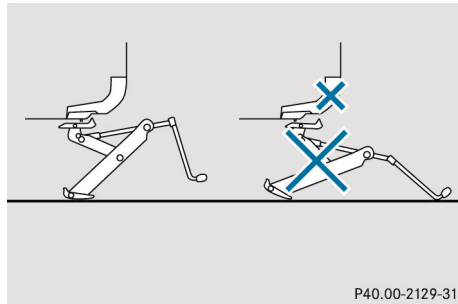

- ▶ Make sure that the base of the jack is positioned directly under jacking point ②.
- ▶ Turn crank ④ clockwise until jack ③ sits completely on jacking point ② and the base of the jack lies evenly on the ground.
- ▶ Turn crank ④ until the tire is raised a maximum of 1.2 inches (3 cm) off the ground.

Removing a wheel

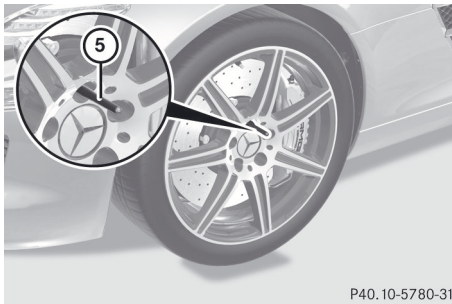

P40.10-5780-31

- ▶ Unscrew the uppermost wheel bolt completely.
- ▶ Screw alignment bolt ⑤ into the thread instead of the wheel bolt.
- ▶ Unscrew the remaining wheel bolts fully.

! Do not place wheel bolts in sand or on a dirty surface. The bolt and wheel hub threads could otherwise be damaged when you screw them in.

! AMG ceramic high performance compound brake system:

When detaching or attaching the wheel, the wheel rim may hit against the ceramic brake disc and damage it.

For this reason, you should proceed carefully. Request the assistance of a second person or use a second alignment bolt.

- ▶ Remove the wheel.

Mounting a new wheel

! WARNING

Always replace wheel bolts that are damaged or rusted.

Never apply oil or grease to wheel bolts.

Damaged wheel hub threads should be repaired immediately. Do not continue to drive under these circumstances! Contact an authorized Mercedes-Benz Center or call Roadside Assistance.

Incorrect wheel bolts or improperly tightened wheel bolts can cause the wheel to come off. This could cause an accident. Make sure to use the correct wheel bolts.

! WARNING

Only use genuine Mercedes-Benz wheel bolts. Other wheel bolts may come loose.

Do not tighten the wheel bolts when the vehicle is raised. Otherwise, the vehicle could fall off the jack.

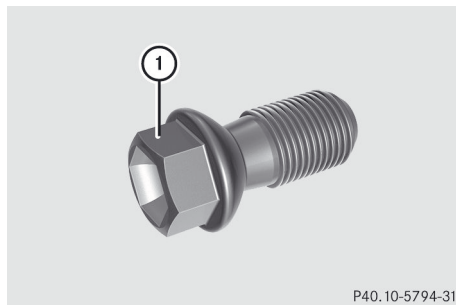

P40.10-5794-31

- ① Wheel bolt

! WARNING

Make sure to use the original length wheel bolts when remounting the original wheel after it has been repaired.

- ▶ Clean the wheel and wheel hub contact surfaces.

! To prevent damage to the paintwork, hold the wheel securely against the wheel hub while screwing in the first wheel bolt.

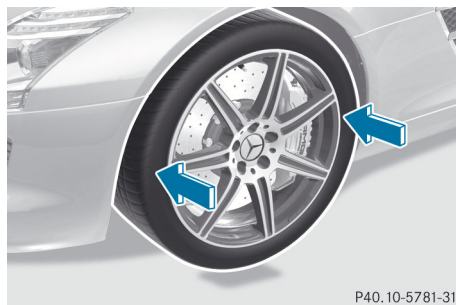

P40.10-5781-31

- ▶ Place the wheel onto the alignment bolt and push it on.



P40.10-5782-31

- ▶ Tighten the wheel bolts until they are finger-tight.
- ▶ Unscrew the alignment bolt.
- ▶ Tighten the last wheel bolt until it is finger-tight.

Lowering the vehicle

- ▶ Turn the crank of the jack counter-clockwise until the vehicle is once again standing firmly on the ground.
- ▶ Place the jack to one side.

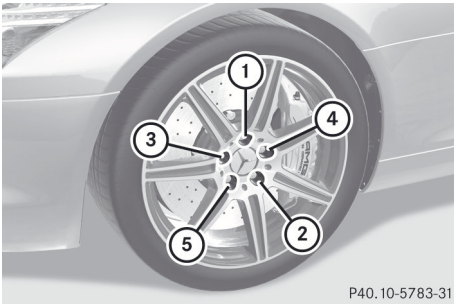

P40.10-5783-31

- ▶ Tighten the wheel bolts evenly in a crosswise pattern in the sequence indicated (① to ⑤). The tightening torque must be **96 lb-ft (130 Nm)**.

WARNING

Have the tightening torque checked immediately after a wheel is changed. The wheels could come loose if they are not tightened to a torque of **96 lb/ft (130 Nm)**.

- ▶ Turn the jack back to the out-of-use position and stow it in the trunk again with the rest of the wheel-changing tools.

Battery

Important safety notes

In order for the battery to achieve the maximum possible service life, it must always be sufficiently charged.

- Have the battery checked regularly at a qualified specialist workshop, such as an authorized Mercedes-Benz Center. Adhere to the service intervals indicated in the Maintenance Booklet or ask a qualified specialist workshop, such as an authorized Mercedes-Benz Center.

Have the battery charge checked more frequently if you use the vehicle mainly for short trips or if you leave it standing idle for a lengthy period.

To prevent damage from corrosion, only replace the battery with one that has a central ventilation cover.

Only replace a battery with a battery that has been recommended by Mercedes-Benz.

Consult an authorized Mercedes-Benz Center if you wish to leave your vehicle parked for a long period of time.

WARNING

Comply with safety precautions and take protective measures when handling batteries.



Risk of explosion



Fire, naked flames and smoking are prohibited when handling the battery. Avoid creating sparks.



Battery acid is caustic. Avoid contact with the skin, eyes or clothing.

Wear suitable protective clothing, in particular gloves, an apron and a face mask.

Immediately rinse acid splashes off with clean water. Consult a doctor if necessary.

Wear eye protection.



Keep children away.



Observe this Operator's Manual.



flush affected area with water and seek medical help if necessary.

A battery will also produce hydrogen gas, which is flammable and explosive. Keep flames or sparks away from battery, avoid improper connection of jumper cables, smoking etc.

WARNING

Do not place any metal objects on the battery as this could result in a short circuit.

Use leak-proof batteries only to avoid the risk of acid burns in the event of an accident.

Take care that you do not become statically charged, e.g. by wearing synthetic clothing or rubbing against textiles. For this reason, you also should not pull or push the battery over carpets or other synthetic materials.

Never touch the battery first. First, touch the outside body of the vehicle in order to release any possible electrostatic charges.

Do not rub the battery with rags or cloths. The battery could explode if touched due to electrostatic charge or due to spark formation.

Environmental note



Batteries contain dangerous substances. It is against the law to dispose of them with the household rubbish. They must be collected separately and recycled to protect the environment.



Dispose of batteries in an environmentally friendly manner. Return discharged batteries to a qualified specialist workshop, e.g. an authorized Mercedes-Benz Center, or to a special collection point for old batteries.

WARNING

Failure to follow these instructions can result in severe injury or death.

Never lean over batteries while connecting. You might get injured.

Battery fluid contains sulfuric acid. Do not allow this fluid to come in contact with eyes, skin or clothing. In case it does, immediately

 Switch off the engine and ensure that no ignition position has been selected before detaching the battery terminals. All indicator lamps in the instrument cluster must be off. Otherwise, you may destroy electronic components such as the alternator.

 Like other batteries, the vehicle battery may discharge over time if you do not use the vehicle. In this case have the battery checked at a qualified specialist workshop, such as an authorized Mercedes-Benz Center. You can also charge the battery with a charger recommended by Mercedes-Benz. Contact an authorized Mercedes-Benz Center for more information.

The battery, breather hose and cover of the positive terminal clamp must be installed securely during operation.

Mercedes-Benz recommends that you do not carry out work on batteries yourself, e.g. removing or charging. Always have this work performed at a qualified specialist workshop, e.g. an authorized Mercedes-Benz Center.

- i** If the battery power supply has been interrupted, e.g. if the battery has been reconnected, you must reset the function for automatically folding the exterior mirrors in/out by folding the mirrors out once (▷ page 90).

Breakdown assistance

Installation location of the battery

Your vehicle is equipped with a battery in the engine compartment. It is installed on the front bulkhead on the right-hand side of the vehicle when viewed in the direction of travel.

- ▶ Shift the transmission to P with the button in the center console.
- ▶ Deactivate all electrical consumers, e.g. radio, automatic climate control, etc.
- ▶ Make sure that the ignition is switched off. All indicator lamps in the instrument cluster must be off.
- ▶ Open the hood (▷ page 2 18).

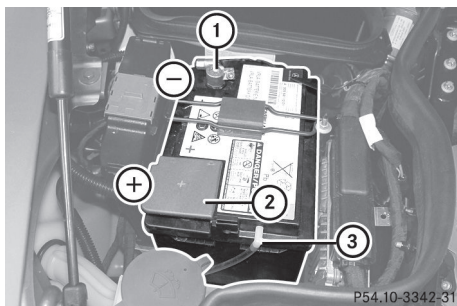

- ① Negative terminal
- ② Positive terminal
- ③ Breather hose

- i** Further related subjects:
 - charging the battery (▷ page 242)
 - jump-starting (▷ page 243)

Charging the battery

⚠ WARNING

Never charge a battery still installed in the vehicle unless a battery charger unit approved by Mercedes-Benz is being used. Gases may escape during charging and cause explosions that may result in paint damage, corrosion or personal injury.

A battery charger unit specially adapted for Mercedes-Benz vehicles and tested and approved by Mercedes-Benz is available as an accessory. It permits the charging of the battery in its installed position. Contact an authorized Mercedes-Benz Center for further information and availability.

Charge the battery in accordance with the separate instructions for the battery charger.

⚠ WARNING

There is a risk of acid burns during the charging process due to the gases which escape from the battery. Do not lean over the battery during the charging process.

⚠ WARNING

Battery acid is caustic. Avoid contact with the skin, eyes or clothing.

- !** Only charge the installed battery with a battery charger which has been tested and approved by Mercedes-Benz. These battery chargers allow the battery to be charged while still installed.
- !** Only use battery chargers with a maximum charging voltage of 14.8 V.
- ▶ Open the hood (▷ page 2 18).
- ▶ Read the battery charger's operating instructions before charging the battery.
- ▶ Connect the battery charger to the positive terminal and earth point in the same order as when connecting the donor battery in the jump-starting procedure (▷ page 243).

Jump-starting

WARNING

Failure to follow these directions will cause damage to the electronic components, and can lead to a battery explosion and severe injury or death.

Never lean over batteries while connecting or jump starting. You might get injured.

Battery fluid contains sulfuric acid. Do not allow this fluid to come in contact with eyes, skin or clothing. In case it does, immediately flush affected area with water, and seek medical help if necessary.

A battery will also produce hydrogen gas, which is flammable and explosive. Keep flames or sparks away from battery, avoid improper connection of jumper cables, smoking, etc.

Attempting to jump start a frozen battery can result in it exploding, causing personal injury.

Read all instructions before proceeding.

! Avoid repeated and lengthy starting attempts. Otherwise, non-combusted fuel may damage the catalytic converter and create a risk of fire.

Do not use a rapid charging device to start the vehicle.

Make sure the jumper cables are not damaged.

Make sure the jumper cables are not touching any other metal objects when they are connected to the battery.

If your vehicle's battery is discharged, the engine can be jump-started from another vehicle or from a second battery using jumper cables.

Observe the following points:

- ▶ The battery is not accessible in all vehicles. If the other vehicle's battery is not accessible, jump-start the vehicle using a second battery or a jump-starting device.
 - ▶ You may only jump-start the vehicle when the engine and catalytic converter are cold.
 - ▶ Do not start the engine if the battery is frozen. Let the battery thaw first.
 - ▶ Jump-starting may only be performed from batteries with a nominal voltage of 12 V.
 - ▶ Only use jumper cables which have a sufficient cross-section and insulated terminal clamps.
 - ▶ Make sure that the jumper cables cannot come into contact with parts, such as the pulley or the fan. These parts move when the engine is started and while it is running.
 - ▶ If the battery is fully discharged, leave the battery that is being used to jump-start connected for a few minutes before attempting to start. This charges the empty battery a little.
- i** Jumper cables and further information about jump-starting can be obtained from any authorized Mercedes-Benz Center, for example.
- ▶ Make sure that the two vehicles do not touch.
 - ▶ Press the electric parking brake handle.
 - ▶ Shift the transmission to **P** with the button in the center console.
 - ▶ Deactivate all electrical consumers, e.g. radio, automatic climate control, etc.
 - ▶ Open the hood (▶ page 218).

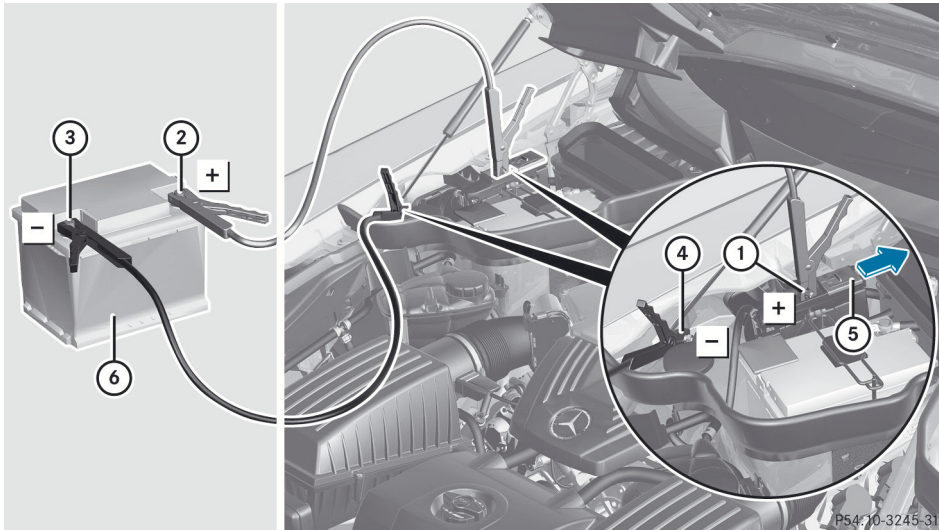

Position number ⑥ identifies the charged battery of the other vehicle or an equivalent jump-starting device.

- ▶ Slide cover ⑤ of positive terminal ① in the direction of the arrow.
- ▶ Connect positive terminal ① on your vehicle to positive terminal ② of donor battery ⑥ using the jumper cable, beginning with your own battery.
- ▶ Start the engine of the donor vehicle and run it at idling speed.
- ▶ Connect negative terminal ③ of donor battery ⑥ to earth point ④ of your vehicle using the jumper cable, connecting the jumper cable to donor battery ⑥ first.
- ▶ Start the engine.
- ▶ First, remove the jumper cable from earth point ④ and negative terminal ③, then from positive terminal ① and positive terminal ②, each time disconnecting from the battery on your own vehicle first.
- ▶ Slide cover ⑤ of the positive terminal in the opposite direction of the arrow.
- ▶ Have the battery checked at a qualified specialist workshop, e.g. an authorized Mercedes-Benz Center.

Towing and tow-starting

Important safety notes

If the vehicle can no longer be driven because of an accident or breakdown, you have the following options:

- transporting the vehicle

As a rule, you should have the vehicle transported.

- towing the vehicle with the rear axle raised
Only tow the vehicle with the rear axle raised in exceptional cases.
- towing the vehicle with a tow rope or tow bar
Only tow the vehicle in exceptional cases. The engine must be running if you tow the

vehicle with a tow rope or tow bar. Observe the following notes.

WARNING

If the brake system is malfunctioning, you must use a rigid tow bar to tow the vehicle.

Before towing away, make sure that the steering can be moved and is not locked.

If there is a malfunction in the power supply or the vehicle's electrical system, you must not tow the vehicle.

WARNING

The following can occur if the vehicle is towed:

- the engine may not start.
- the on-board electronics may fail.
- the battery voltage may drop too much.

In these cases, the rear axle will be locked.

As a result, you might lose control of the vehicle, cause an accident and injure yourself and others.

- ❗ Use the SmartKey instead of the Start/ Stop button when towing the vehicle.

Start the engine and keep it running. Turn the SmartKey to position **2** in the ignition. Set the transmission to **N** using the E-SELECT lever. Make sure that you then leave the SmartKey in position **2**.

Check the transmission position in the instrument cluster.

- ❗ Make sure that the electric parking brake is released. If the electric parking brake is faulty, visit a qualified specialist workshop. Mercedes-Benz recommends that you use an authorized Mercedes-Benz Center for this purpose.

- ❗ When towing, pull away slowly and smoothly. If the tractive power is too high, the vehicles could be damaged.

- ❗ Only secure the tow rope or tow bar at the towing eyes. Otherwise, the vehicle could be damaged.

- ❗ Do not use the towing eye for recovery, as this could damage the vehicle. If in doubt, recover the vehicle with a crane.

- ❗ You may only tow the vehicle a maximum distance of 30 miles (50 km). A towing speed of 30 mph (50 km/h) must not be exceeded.

For towing distances over 30 miles (50 km), the vehicle must be loaded onto a transporter.

- ❗ Do not tow with sling-type equipment. This could damage the vehicle.

- ❗ Tow-starting the vehicle is not permitted. The transmission may otherwise be damaged.

Also observe the following notes:

- if the engine does not start, try jump-starting it (▷ page 243). Tow-starting the vehicle is not permitted.
- if it is not possible to jump-start the vehicle, have it transported to the nearest qualified specialist workshop, e.g. an authorized Mercedes-Benz Center.
- if the transmission has been damaged, have the vehicle transported to the nearest qualified specialist workshop, e.g. an authorized Mercedes-Benz Center. Observe the display messages in the instrument cluster.

Installing/removing the towing eye

Installing the towing eye

- ▶ Take the towing eye and the wheel wrench¹⁷ out of the wheel-change tool kit (▷ page 232).

The bracket for the removable towing eye is in the bumper at the front. It is located under the cover.

¹⁷ Not included in the scope of delivery.

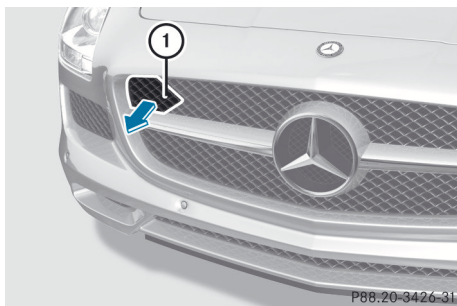

- ▶ Pull out cover ① forwards.
- ▶ Take cover ① off the opening.

Removing the towing eye

- ▶ Take the lug wrench¹⁷ from the wheel-change tool kit (▷ page 232).
- ▶ Insert the lug wrench handle into the towing eye and turn it counter-clockwise.
- ▶ Unscrew the towing eye.
- ▶ Attach cover ① to the bumper and press until it engages.
- ▶ Return the towing eye and the lug wrench to the wheel-change tool kit.

Towing the vehicle with the rear axle raised

When towing your vehicle with the rear axle raised, it is important that you observe the safety instructions (▷ page 244).

Only tow the vehicle with the rear axle raised in exceptional cases.

- ❗ The engine must be switched off (SmartKey in ignition lock in position **0** or position **1**) if the vehicle is being towed with the rear axle raised or if the parking brake is being tested on a dynamometer. Intervention by ESP[®] could otherwise damage the brake system.

- ▶ Switch on the hazard warning lamps (▷ page 96).
- ▶ Make sure that the SmartKey is in position **2** in the ignition and that the engine is running throughout the towing procedure.
- ▶ Move the transmission to **N** with the E-SELECT lever. Check the transmission position in the instrument cluster.

Towing a vehicle with both axles on the ground

When having your vehicle towed, observe the important safety notes (▷ page 244).

- ▶ Switch on the hazard warning lamps (▷ page 96).
- ❗ When towing with the hazard warning lamps switched on, use the combination switch as usual to signal a change of direction. In this case, only the turn signals for the desired direction flash. When the combination switch is reset, the hazard warning lamps start flashing again.
- ▶ Insert the SmartKey into the ignition lock (▷ page 115).
- ▶ Start the engine and leave the SmartKey in the ignition.
- ▶ Move the transmission to **N** with the E-SELECT lever.
- ▶ Check the transmission position in the instrument cluster display (▷ page 121).
- ▶ Leave the engine running during the entire towing procedure.

Transporting the vehicle

The towing eye can be used to pull the vehicle onto a trailer or transporter for transporting purposes.

- ❗ Only lash the vehicle down by the wheels or wheel rims, not by parts of the vehicle

¹⁷ Not included in the scope of delivery.

such as axle or steering components. Otherwise, the vehicle could be damaged.

- ▶ Start the engine.
- ▶ Make sure that the SmartKey is in position **2** in the ignition and that the engine is running during the entire loading operation.
- ▶ Move the transmission to **N** with the E-SELECT lever. Check the transmission position in the instrument cluster.

As soon as the vehicle is loaded:

- ▶ Prevent the vehicle from rolling away by applying the electric parking brake.
- ▶ Shift the transmission to **P** with the button in the center console.
- ▶ Turn the SmartKey to position **0** in the ignition lock and remove the SmartKey from the ignition lock.
- ▶ Secure the vehicle.

Fuses

Important safety notes

WARNING

Only use fuses approved by Mercedes-Benz with the specified amperage for the system in question and do not attempt to repair or bridge a blown fuse. Using other than approved fuses or using repaired or bridged fuses may cause an overload leading to a fire, and/or cause damage to electrical components and/or systems. Have the cause determined and remedied by an authorized Mercedes-Benz Center.

- ❗ Only use fuses that have been approved for Mercedes-Benz vehicles and which have the correct fuse rating for the system concerned. Otherwise, components or systems could be damaged.

The fuses in your vehicle serve to close down faulty circuits. If a fuse blows, all the components on the circuit and their functions stop operating.

Blown fuses must be replaced with fuses of the same rating, which you can recognize by the color and value. The fuse ratings are listed in the fuse allocation chart. An authorized Mercedes-Benz Center will be happy to advise you.

-  If a fuse has blown, contact a breakdown service or an authorized Mercedes-Benz Center.

If the newly inserted fuse also blows, have the cause traced and rectified at a qualified specialist workshop, e.g. an authorized Mercedes-Benz Center.

Before changing a fuse

- ▶ Park the vehicle and apply the electric parking brake.
- ▶ Switch off all electrical consumers.
- ▶ Remove the SmartKey from the ignition lock.

The fuses are located in various fuse boxes:

- fuse box in the footwell on the front-passenger side
- fuse box in the rear

The "Relay and fuse information sheet" is located with the wheel-change toolkit in the trunk.

Fuse box in the footwell

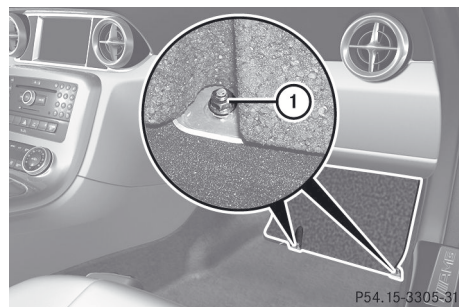

- ▶ **To open:** remove the carpet over the footrest.
- ▶ Loosen screws ① on the floor panel using a suitable tool.
- ▶ Remove the floor panel.
- ▶ **To close:** install the floor panel again.
- ▶ Screw in and tighten screws ①.
- ▶ Put in the carpet and press to secure.

❗ The floor panel must be installed properly, otherwise moisture or dirt could impair the function of the fuses.

Breakdown assistance

Fuse box in the rear

Coupe

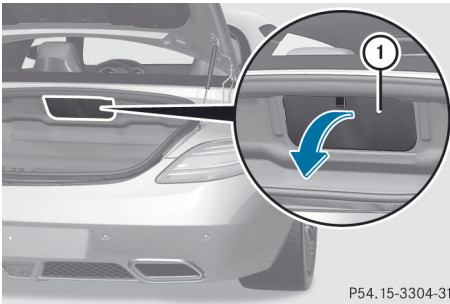

P54.15-3304-31

- ▶ **To open:** open the trunk.
- ▶ Fold cover ① in the center of the rear wall down in the direction of the arrow.
- ▶ **To close:** fold cover ① up in the opposite direction to the arrow and press to secure.

❗ The cover must be installed properly, otherwise moisture or dirt could impair the function of the fuses.

Roadster

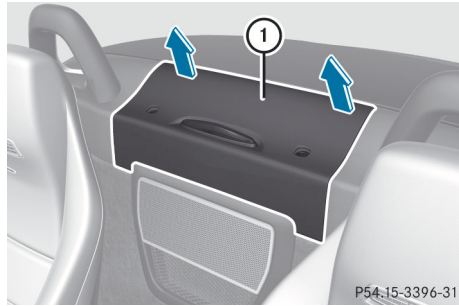

P54.15-3396-31

- ▶ **To open:** from the vehicle interior, lift up cover ① between the roll bars in the direction of the arrow.
- ▶ **To close:** shut cover ① in the opposite direction to the arrow and press to secure.

❗ The cover must be installed properly, otherwise moisture or dirt could impair the function of the fuses.

Useful information	250
Important safety notes	250
Operation	250
Winter operation	252
Tire pressure	253
Loading the vehicle	259
Maximum load rating	263
Uniform Tire Quality Grading Standards	263
Tire labeling	265
Definition of terms for tires and loading	268
Changing a wheel	271
Wheel and tire combinations	272

Useful information

- i** This Operator's Manual describes all models and all standard and optional equipment of your vehicle available at the time of publication of the Operator's Manual. Country-specific differences are possible. Please note that your vehicle may not be equipped with all features described. This also applies to safety-related systems and functions.
- i** Please read the information on qualified specialist workshops (▷ page 21).

Important safety notes

Consult an authorized Mercedes-Benz Center if you require information on approved and recommended tires and wheels for summer and winter operation. Advice on purchasing and caring for tires is also available there.

WARNING

Replace rims or tires with the same designation, manufacturer and type as shown on the original part. For further information contact an authorized Mercedes-Benz Center. If incorrectly sized rims and tires are mounted, the wheel brakes or suspension components can be damaged. Also, the operating clearance of the wheels and the tires may no longer be correct.

WARNING

Worn, old tires can cause accidents. If the tire tread is worn to minimum tread depth, or if the tires have sustained damage, replace them.

When replacing rims, only use genuine Mercedes-Benz wheel bolts specified for the particular rim type. Failure to do so can result in the bolts loosening and possibly an accident.

Retreaded tires are not tested or recommended by Mercedes-Benz, since previous damage cannot always be

recognized on retreads. The operating safety of the vehicle cannot be assured when such tires are used.

WARNING

If you feel a sudden significant vibration or ride disturbance, or you suspect that possible damage to your vehicle has occurred, you should turn on the hazard warning flashers, carefully slow down, and drive with caution to an area which is a safe distance from the road.

Inspect the tires and the vehicle underbody for possible damage. If the vehicle appears unsafe, have the vehicle towed to the nearest authorized Mercedes-Benz Center or tire dealer for repairs.

WARNING

Do not drive with a flat tire. A flat tire affects the ability to steer or brake the vehicle. You might lose control of the vehicle. Continued driving with a flat tire or driving at high speed with a flat tire will cause excessive heat build-up and possibly a fire.

- i** Further information about tires and wheels can be obtained from any authorized Mercedes-Benz Center.

Operation

Notes on driving

- If the vehicle is heavily laden, check the tire pressures and correct them if necessary.
- When parking your vehicle, make sure that the tires do not get deformed by the curb or other obstacles. If it is necessary to drive over curbs, speed humps or similar elevations, try to do so slowly and at an obtuse angle. Otherwise, the tires, particularly the sidewalls, can get damaged.

Notes on regularly inspecting wheels and tires

WARNING

Regularly check the tires for damage. Damaged tires can cause tire inflation pressure loss. As a result, you could lose control of your vehicle.

Worn, old tires can cause accidents. If the tire tread is worn to minimum tread depth, or if the tires have sustained damage, replace them.

- Regularly check the wheels and tires of your vehicle for damage (e.g. cuts, punctures, tears, bulges on tires and deformation or cracks or severe corrosion on wheels) at least once a month, as well as after driving off-road or on rough roads. Damaged wheels can cause a loss of tire pressure.
- Regularly check the tire tread depth and the condition of the tread across the whole width of the tire (▷ page 251). If necessary, turn the front wheels to full lock in order to inspect the inner side of the tire surface.
- All wheels must have a valve cap to protect the valve against dirt and moisture. Do not mount anything onto the valve (such as tire pressure monitoring systems) other than the standard valve cap or other valve caps approved by Mercedes-Benz for your vehicle.
- Regularly check the pressure of all the tires including the emergency spare wheel or the spare wheel, particularly prior to long trips, and correct the pressure as necessary (▷ page 253).

Tire tread

WARNING

Although the applicable federal motor vehicle safety laws consider a tire to be worn when the tread wear indicators (TWI) become visible at approximately $1/16$ in (1.6 mm), we

recommend that you do not allow your tires to wear down to that level. As tread depth approaches $1/8$ in (3 mm), the adhesion properties on a wet road are sharply reduced. Depending upon the weather and/or road surface (conditions), the tire traction varies widely.

Do not use tires that are excessively worn as the tire traction on wet road surfaces decreases significantly when the tread depth is less than $1/8$ inch (3 mm).

Tread wear indicators (TWI) are required by law. Six indicators are positioned on the tire tread. They become visible as soon as a tread depth of approximately $1/16$ inch (1.6 mm) has been reached. If this is the case, the tire is so worn that it must be replaced.

The recommended tread depth for summer tires is at least $1/8$ inch (3 mm). The recommended tread depth for winter tires is at least $1/6$ inch (4 mm).

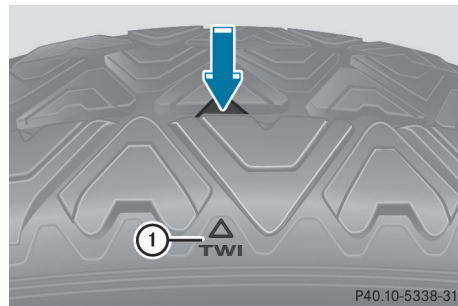

Bar marking ① for tread wear is integrated into the tire tread.

Notes on selecting, mounting and replacing tires

- Only mount tires and wheels of the same type and make.
- Only mount tires of the correct size onto the wheels.
- After mounting new tires, run them in at moderate speeds for the first 60 miles

(100 km) as they only reach their full performance after this distance.

- Do not use tires that are excessively worn as the tire traction on wet road surfaces decreases significantly when the tread depth is less than $\frac{1}{8}$ inch (3 mm).
- Replace the tires after six years at the latest, regardless of wear. This also applies to the spare wheel/emergency spare wheel.

The service life of tires depends on the following factors amongst other things:

- driving style
- tire pressure
- mileage

Winter operation

General notes

Have your vehicle winterproofed at a qualified specialist workshop at the onset of winter. Observe the notes in the "Changing a wheel" section (▷ page 271).

Driving with summer tires

At temperatures below 45 °F (+7 °C), the elasticity of summer tires and therefore also the traction and braking capability are reduced considerably – equip your vehicle with M+S tires. Using summer tires at very cold temperatures could cause tears to form, thereby damaging the tires permanently. Mercedes-Benz cannot accept responsibility for this type of damage.

Snow chains

- ❗ There is not enough space for snow chains on some wheel sizes. Observe the information under "Tires and wheels" in the "Technical Data" section to avoid damage to the vehicle or the wheels.

For safety reasons, Mercedes-Benz recommends that you only use snow chains that have been specially approved for your vehicle by Mercedes-Benz, or are of a corresponding standard of quality.

- local regulations may restrict the use of snow chains. Observe the appropriate regulations if you wish to mount snow chains.
- only use snow chains when driving on roads completely covered by snow. Remove the snow chains as soon as possible when you come to a road that is not snow-covered.
- Do not exceed the maximum permissible speed of 30 mph (50 km/h).
- you may not mount snow chains to all wheel-tire combinations; see the information under "Wheels and tires" in the "Technical data" section.
- snow chains must not be mounted on emergency spare wheels.
- mount snow chains only in pairs and only on the rear wheels. Observe the manufacturer's installation instructions.

- ❗ If snow chains are mounted on the front wheels, the snow chains could grind against the bodywork or components of the chassis. This could result in damage to the vehicle or the tires.

- i You may wish to deactivate ESP® (▷ page 56) when pulling away with snow chains mounted. This way you can allow the wheels to spin in a controlled manner, achieving an increased driving force (cutting action).

M+S tires

WARNING

M+S tires with a tread depth of less than $\frac{1}{6}$ inch (4 mm) must be replaced. They are no longer suitable for winter operation.

⚠ WARNING

If you mount the spare wheel when driving with M+S tires, bear in mind that driving stability will be impaired due to unstable cornering characteristics caused by the different tire characteristics. Adapt your style of driving accordingly.

Have the spare wheel replaced by a normal wheel with an M+S tire at the nearest Mercedes-Benz Center.

At temperatures below 45 °F(+7 °C), use winter tires or all-season tires. Both types of tire are identified by the M+S marking.

Only winter tires bearing the  snowflake symbol in addition to the M+S marking provide the best possible grip in wintry road conditions. Only these tires will allow driving safety systems such as ABS and ESP® to function optimally in winter, as these tires have been designed specifically for driving on snow.

Use M+S tires of the same make and tread on all wheels to maintain safe handling characteristics.

Always observe the maximum permissible speed specified for the M+S tires you have mounted.

When you have installed the M+S tires:

- ▶ Check the tire pressures (▷ page 253).
- ▶ Restart the tire pressure monitor (▷ page 259).

Tire pressure**Tire pressure specifications****⚠ WARNING**

Follow recommended tire inflation pressures.

Do not underinflate tires. Underinflated tires wear excessively and/or unevenly, adversely affect handling and fuel economy, and are more likely to fail from being overheated.

Do not overinflate tires. Overinflated tires can adversely affect handling and ride comfort,

wear unevenly, increase stopping distance, and result in sudden deflation (blowout) because they are more likely to become punctured or damaged by road debris, potholes etc.

Do not overload the tires by exceeding the specified load limit as indicated on the Tire and Loading Information placard on the driver's door B-pillar. Overloading the tires can overheat them, possibly causing a blowout. Overloading the tires can also result in handling or steering problems, or brake failure.

You will find a table of recommended tire pressures on the Tire and Loading Information placard on the B-pillar on the driver's side (▷ page 259). You will find a table of tire pressures for various operating conditions on the inside of your vehicle's fuel filler flap.

To test tire pressure, use a suitable pressure gauge. The outer appearance of a tire does not permit any reliable conclusion about the tire pressure. On vehicles equipped with the electronic tire pressure monitoring system, the tire pressure can be checked using the on-board computer.

⚠ WARNING

Should the tire pressure drop repeatedly:

- check the tire for foreign bodies.
- check whether the wheel is losing air or the valve is leaking.
- make sure that only a valve cap approved by Mercedes-Benz is installed on the tire valve.

Tire pressures that are too low have a negative effect on vehicle safety, which could lead you to cause an accident.

Only correct tire pressures when the tires are cold. The tires are cold when the vehicle has been parked for at least three hours or driven for less than 1 mile (1.6 km). The tire temperature changes depending on the outside temperature, the vehicle speed and

the tire load. If the tire temperature changes by 18 °F (10 °C), the tire pressure changes by approximately 10 kPa (0.1 bar/1.5 psi). Take this into account when checking the pressure of warm tires and only correct the tire pressure if it is too low for the current operating conditions. If you check the tire pressure when the tires are warm, the resulting value will be higher than if the tires were cold. This is normal. Do not reduce the tire pressure to the value specified for cold tires. The tire pressure would otherwise be too low.

Observe the recommended tire pressure specifications for cold tires on the Tire and Loading Information placard on the B-pillar on the driver's side.

- i** The specifications given on the following Tire and Loading Information placard are examples. Tire pressure specifications are vehicle-specific and may deviate from the data shown here. The tire pressures applicable to your vehicle can be found on the Tire and Loading Information placard on your vehicle.

TIRE AND LOADING INFORMATION
RENSEIGNEMENTS POUR LES PNEUS ET LE CHARGEMENT

SEATING CAPACITY / NOMBRE DE SIÈGES: TOTAL 7, FRONT / AVANT 2, MIDDLE / MILIEU 3, REAR / ARRIÈRE 2

The combined weight of occupants and cargo should never exceed XXXX kg or XXXX lbs.*
Le poids total des occupants et des marchandises ne doit jamais dépasser XXXX kg ou XXXX lb.*

TIRE / PNEU	SIZE / TAILLE	COLD TIRE PRESSURE / PRESSION DES PNEUS À FROID	SEE OWNERS MANUAL FOR ADDITIONAL INFORMATION
FRONT / AVANT	255/40 ZR18 99V XL	200 KPA, 29 PSI	
REAR / ARRIÈRE	285/35 ZR18 101Y XL	200 KPA, 29 PSI	
SPARE / DE RECHANGE	175/55-18 95P	420 KPA, 60 PSI	

P40.00-2133-31

You will find recommended tire pressure specifications **1** for cold tires and for a fully loaded vehicle on the Tire and Loading Information placard. The tire pressure information is applicable to all tires mounted at the factory.

Important notes on tire pressure

⚠ WARNING

If the tire pressure drops repeatedly, check the tires for punctures from foreign objects and/or whether air is leaking from the valves or from around the rim.

The tire temperature and pressure increase when the vehicle is in motion. This is dependent on the driving speed and the load. If you wish to drive at high speeds of 100 mph (160 km/h) or higher when this is allowed, use the tire pressure table on the inside of the fuel filler flap to set the correct tire pressures when the wheels are cold. If the tire pressure is not set correctly, this can lead to an excessive build-up of heat and a sudden loss of pressure.

For more information, contact a qualified specialist workshop.

- i** Driving comfort can be impaired if the tire pressure value recommended in the tire pressure table for speeds over 100 mph (160 km/h) is adopted.

Make sure that the tire pressure for normal speeds is adopted again.

Additional specifications of tire pressure values for loads can also be found on the tire pressure table on the inside of the fuel filler flap.

- i** Specifications shown in the examples of tire pressure tables are for illustration purposes only. Tire pressure specifications are vehicle-specific and may deviate from the data shown here. Tire pressure specifications applicable to your vehicle are located in your vehicle's tire pressure table.

Unless stated otherwise, the tire pressures specified on the fuel filler flap apply to all tires approved for this vehicle.

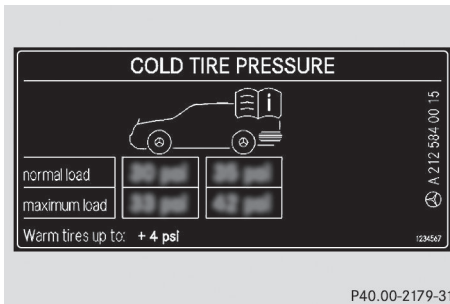

Example: tire pressure table for all tires permitted for this vehicle by the factory

If a tire size precedes a tire pressure, the tire pressure information following is only valid for that tire size. The load conditions "partially laden" and "fully laden" are defined in the table for different numbers of passengers and amounts of luggage. The actual number of seats may differ.

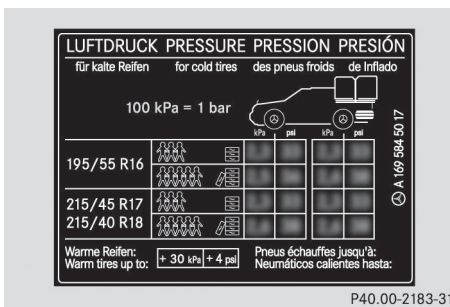

Example: tire pressure table with tire dimensions

Some tire pressure tables show only the rim diameters instead of the full tire size, e.g. **R18**. The rim diameter is part of the tire size and can be found on the tire sidewall (▷ page 265).

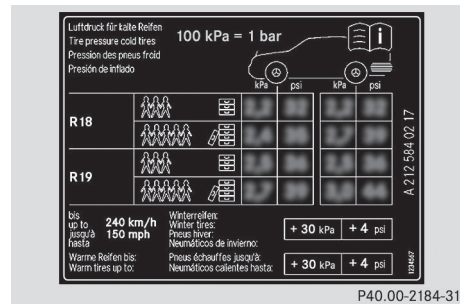

Underinflated or overinflated tires

Underinflation

⚠ WARNING

Follow recommended tire inflation pressures. Do not underinflate tires. Underinflated tires wear excessively and/or unevenly, adversely affect handling and fuel economy, and are more likely to fail from being overheated.

Underinflated tires may:

- wear quickly and unevenly
- have an adverse effect on fuel consumption
- overheat, leading to tire defects
- have an adverse effect on handling characteristics

Overinflation

⚠ WARNING

Follow recommended tire inflation pressures. Do not overinflate tires. Overinflated tires can adversely affect handling and ride comfort, wear unevenly, increase stopping distance, and result in sudden deflation (blowout) because they are more likely to become punctured or damaged by road debris, potholes etc.

Overinflated tires may:

- have an adverse effect on handling characteristics
- wear quickly and unevenly

- be more susceptible to damage
- have an adverse effect on ride comfort
- increase the braking distance

Maximum tire pressure

WARNING

Never exceed the maximum tire inflation pressure. Follow recommended tire inflation pressures.

Do not underinflate tires. Underinflated tires wear excessively and/or unevenly, adversely affect handling and fuel economy, and are more likely to fail from being overheated.

Do not overinflate tires. Overinflated tires can adversely affect handling and ride comfort, wear unevenly, increase stopping distance, and result in sudden deflation (blowout) because they are more likely to become punctured or damaged by road debris, potholes etc.

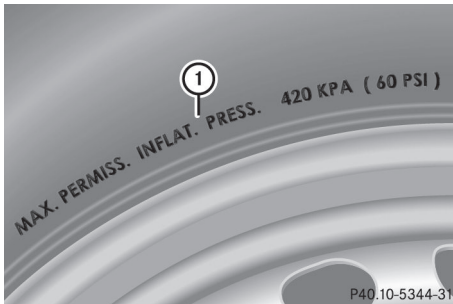

- ① Example: maximum permissible tire pressure
- i** The actual values for tires are vehicle-specific and may deviate from the values in the illustration.

Always observe the recommended tire pressure for your vehicle when adjusting the tire pressure (▷ page 253).

Checking the tire pressures

Important safety notes

WARNING

Follow recommended tire inflation pressures.

Do not underinflate tires. Underinflated tires wear excessively and/or unevenly, adversely affect handling and fuel economy, and are more likely to fail from being overheated.

Do not overinflate tires. Overinflated tires can adversely affect handling and ride comfort, wear unevenly, increase stopping distance, and result in sudden deflation (blowout) because they are more likely to become punctured or damaged by road debris, potholes etc.

Do not overload the tires by exceeding the specified load limit as indicated on the Tire and Loading Information placard on the driver's door B-pillar. Overloading the tires can overheat them, possibly causing a blowout. Overloading the tires can also result in handling or steering problems, or brake failure.

Check the tire pressures at least once a month.

Only check and correct tire pressures when the tires are cold (▷ page 253).

Checking tire pressures manually

To determine and set the correct tire pressure, proceed as follows:

- ▶ Remove the valve cap of the tire that is to be checked.
- ▶ Press the tire pressure gauge securely onto the valve.
- ▶ Read the tire pressure and compare it with the recommended value on the Tire and Loading Information placard on the B-pillar on the driver's side of your vehicle.
- ▶ If necessary, increase the tire pressure to the recommended value (▷ page 253).
- ▶ If the tire pressure is too high, release air by pressing down the metal pin in the valve

using the tip of a pen, for example. Then check the tire pressure again using the tire pressure checker.

- ▶ Screw the valve cap onto the valve.
- ▶ Repeat these steps for the other tires.

Tire pressure monitor

Important safety notes

If a tire pressure monitor system is installed, the vehicle's wheels have sensors that monitor the tire pressures in all four tires. The tire pressure monitor warns you if the pressure drops in one or more of the tires. The tire pressure monitor only functions if the correct wheel electronics units are installed on each wheel.

The tire pressure monitor has a yellow warning lamp in the instrument cluster for indicating pressure loss/malfunctions (USA) or pressure loss (Canada). Whether the warning lamp flashes or lights up indicates whether a tire pressure is too low or the tire pressure monitoring system is malfunctioning:

- if the warning lamp is lit continuously, the tire pressure on one or more tires is significantly too low. The tire pressure monitor is not malfunctioning.
- USA only: if the warning lamp flashes for 60 seconds and then remains lit constantly, the tire pressure monitor is malfunctioning.

WARNING

Each tire, including the spare (if provided), should be checked at least once a month when cold and inflated to the pressure recommended by the vehicle manufacturer on the Tire and Loading Information placard on the driver's door B-pillar or the tire pressure label on the inside of the fuel filler flap. If your vehicle has tires of a different size than the size indicated on the Tire and Loading Information placard or the tire pressure label,

you should determine the proper tire pressure for those tires.

As an added safety feature, your vehicle has been equipped with a tire pressure monitoring system (TPMS) that illuminates a low tire pressure telltale when one or more of your tires are significantly underinflated.

Accordingly, when the low tire pressure telltale illuminates, you should stop and check your tires as soon as possible, and inflate them to the proper pressure. Driving on a significantly underinflated tire causes the tire to overheat and can lead to tire failure.

Underinflation also reduces fuel efficiency and tire tread life, and may affect the vehicle's handling and stopping ability. Please note that the TPMS is not a substitute for proper tire maintenance, and it is the driver's responsibility to maintain correct tire pressure, even if underinflation has not reached the level to trigger illumination of the TPMS low tire pressure telltale.

USA only:

Your vehicle has also been equipped with a TPMS malfunction indicator to indicate when the system is not operating properly. The TPMS malfunction indicator is combined with the low tire pressure telltale. When the system detects a malfunction, the telltale will flash for approximately 1 minute and then remain continuously illuminated. This sequence will continue upon subsequent vehicle start-ups as long as the malfunction exists. When the malfunction indicator is illuminated, the system may not be able to detect or signal low tire pressure as intended. TPMS malfunctions may occur for a variety of reasons, including the installation of incompatible replacement or alternate tires or wheels on the vehicle that prevent the TPMS from functioning properly. Always check the TPMS malfunction telltale after replacing one or more tires or wheels on your vehicle to ensure that the replacement or alternate tires and wheels allow the TPMS to continue to function properly.

i USA only:

If the tire pressure monitor is malfunctioning, it may take more than 10 minutes for the tire pressure warning lamp to inform you of the malfunction by flashing for 60 seconds and then remaining lit.

When the malfunction has been rectified, the tire pressure warning lamp goes out after a few minutes of driving.

Information on tire pressures is displayed in the multifunction display. After a few minutes of driving, the current tire pressure of each tire is shown in the multifunction display.

i The tire pressure values indicated by the on-board computer may differ from those measured at a gas station with a pressure gauge. The tire pressures shown by the on-board computer refer to those measured at sea level. At high altitudes, the tire pressure values indicated by a pressure gauge are higher than those shown by the on-board computer. In this case, do not reduce the tire pressures.

i The operation of the tire pressure monitor can be affected by interference from radio transmitting equipment (e.g. radio headphones, two-way radios) that may be being operated in or near the vehicle.

i USA only:

This device complies with Part 15 of the FCC Rules. Operation is subject to the following two conditions:

1. This device may not cause interference, and
2. this device must accept any interference received, including interference that may cause undesired operation.





Any unauthorized modification to this device could void the user's authority to operate the equipment.

i Canada only:

This device complies with RSS-210 of Industry Canada. Operation is subject to the following two conditions:

1. This device may not cause interference, and
 2. this device must accept any interference received, including interference that may cause undesired operation of the device.
- Any unauthorized modification to this device could void the user's authority to operate the equipment.

Checking tire pressure electronically

- ▶ Select key position **2** with the Start/Stop button (▷ page 115).
- ▶ Press the  or  button to select the **Service** menu.
- ▶ Press the  or  button to select **TIRE PRESS..**
- ▶ Press the  button.

The current tire pressure for each wheel will be displayed in the multifunction display.

If the vehicle is parked for longer than 20 minutes and you then drive at less than 25 km/h, the **Tire pressures will be displayed after driving a few minutes** message appears.

After a teach-in period, the tire pressure monitor automatically recognizes new wheels or new sensors. As long as a clear allocation of the tire pressure values to the individual wheels is not possible, the **Tire Pressure Monitor Active** display message is shown instead of the tire pressure display. The tire pressures are already being monitored.

Tire pressure monitor warning messages

If the tire pressure monitor detects a significant pressure loss on one or more tires, a warning message is shown in the multifunction display. A warning tone also sounds and the tire pressure warning lamp lights up in the instrument cluster.

Each tire that is affected by a significant loss of pressure is highlighted with a color.

If the following message appears in the multifunction display: **Correct Tire Pressure**

- ▶ Check the tire pressure on all four wheels and correct it if necessary.

i If the wheel positions on the vehicle are interchanged, the tire pressures may be displayed for the wrong positions for a short time. This is rectified after a few minutes of driving, and the tire pressures are displayed for the correct positions.

Restarting the tire pressure monitor

When you restart the tire pressure monitor, all existing warning messages are deleted and the warning lamps go out. The monitor uses the currently set tire pressures as the specified values for monitoring.





In most cases, the tire pressure monitor will automatically detect the new reference values, e.g. if you have:

- changed the tire pressure
- changed the wheels or tires
- mounted new wheels or tires

If you are defining the new reference values manually:

- ▶ Use the table on the inside of the fuel filler flap to ensure that the tire pressure is set correctly in all four tires for the current operating conditions.

Also observe the notes in the section on tire pressures (> page 253).

- ▶ Select key position **2** with the Start/Stop button.
- ▶ Press the  or  button to select the **Service** menu.
- ▶ Press the  or  button to select **TIRE PRESS..**
- ▶ Press the  button.
The display shows either the current tire pressure for the individual tires or the



Tire pressures will be displayed after driving a few minutes message.

- ▶ Press the  button.
The **Use Current Pressures as New Reference Values** message appears in the multifunction display.

- ▶ Press the  button.
The **Tire Press. Monitor Restarted** message appears in the multifunction display.

After a few minutes of driving, the current pressures are adopted as the new monitoring values.

Canceling the restart

- ▶ Press the  button.
- or
- ▶ Press the  button to leave the menu.

Loading the vehicle

Instruction labels for tires and loads

WARNING

Do not overload the tires by exceeding the specified load limit as indicated on the Tire and Loading Information placard on the driver's door B-pillar. Overloading the tires can overheat them, possibly causing a blowout. Overloading the tires can also result in handling or steering problems, or brake failure.

Two instruction labels on your vehicle show the maximum possible load.

- (1) The Tire and Loading Information placard is on the B-pillar on the driver's side. The Tire and Loading Information placard shows the maximum permissible number of occupants and the maximum permissible vehicle load. It also contains details of the tire sizes and

corresponding pressures for tires installed at the factory.

- (2) The vehicle identification plate is on the B-pillar on the driver's side. The vehicle identification plate informs you of the gross vehicle weight rating. It is made up of the vehicle weight, all vehicle occupants, the fuel and the cargo. You can also find information about the maximum gross axle weight rating on the front and rear axle.

The maximum gross axle weight rating is the maximum weight that can be carried by one axle (front or rear axle). Never exceed the maximum load or the maximum gross axle weight rating for the front or rear axle.

Tires and wheels

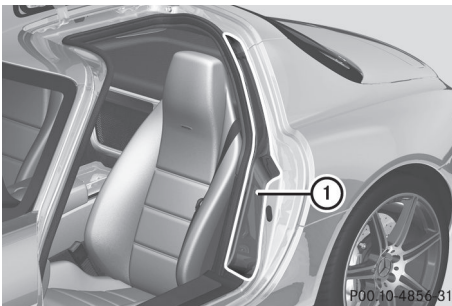

- ① B-pillar, driver's side

Maximum permissible gross vehicle weight rating

- i** The specifications shown on the Tire and Loading Information placard in the illustration are examples. The maximum permissible gross vehicle weight rating is vehicle-specific and may differ from that in the illustration. You can find the valid maximum permissible gross vehicle weight rating for your vehicle on the Tire and Loading Information placard.

TIRE LOADING INFORMATION
RENSEIGNEMENTS POUR LES PNEUS ET LE CHARGEMENT

SEATING CAPACITY / NOMBRE DE SIÈGES: TOTAL 7, FRONT 2, MIDDLE 3, REAR 2

The combined weight of occupants and cargo should never exceed XXXX kg or XXXX lbs.
Le poids total des occupants et des marchandises ne doit jamais dépasser XXXX kg ou XXXX lb.*

TIRE PNEU	SIZE TAILLE	COLD TIRE PRESSURE / PRESSION DES PNEUS À FROID	SEE OWNERS MANUAL FOR ADDITIONAL INFORMATION
FRONT AVANT	265/40 ZR18 99YXL	200 KPA, 29 PSI	
REAR ARRIÈRE	285/35 ZR18 101YXL	200 KPA, 29 PSI	
SPARE DE RECHANGE	175/55-18 95P	420 KPA, 60 PSI	

P40.00-2131-31

- The Tire and Loading Information placard gives you details on maximum permissible gross vehicle weight rating ①: "The gross weight of occupants and luggage must never exceed XXX kilograms or XXX pounds."

The gross weight of all vehicle occupants, cargo, luggage and trailer load/noseweight (if applicable) must not exceed the specified value.

Number of seats

- i** The specifications shown on the Tire and Loading Information placard in the illustration are examples. The number of seats is vehicle-specific and can differ from the details shown. The number of seats in your vehicle can be found on the Tire and Loading Information placard.

TIRE LOADING INFORMATION
RENSEIGNEMENTS POUR LES PNEUS ET LE CHARGEMENT

SEATING CAPACITY / NOMBRE DE SIÈGES: TOTAL 7, FRONT 2, MIDDLE 3, REAR 2

The combined weight of occupants and cargo should never exceed XXXX kg or XXXX lbs.
Le poids total des occupants et des marchandises ne doit jamais dépasser XXXX kg ou XXXX lb.*

TIRE PNEU	SIZE TAILLE	COLD TIRE PRESSURE / PRESSION DES PNEUS À FROID	SEE OWNERS MANUAL FOR ADDITIONAL INFORMATION
FRONT AVANT	265/40 ZR18 99YXL	200 KPA, 29 PSI	
REAR ARRIÈRE	285/35 ZR18 101YXL	200 KPA, 29 PSI	
SPARE DE RECHANGE	175/55-18 95P	420 KPA, 60 PSI	

P40.00-2132-31

Maximum number of seats ① determines the maximum number of occupants allowed to travel in the vehicle. This information can be

found on the Tire and Loading Information placard.

Determining the correct load limit

Step-by-step instructions

The following steps have been developed as required of all manufacturers under Title 49, Code of U.S. Federal Regulations, Part 575 pursuant to the "National Traffic and Motor Vehicle Safety Act of 1966".

- ▶ **Step 1:** Locate the statement "The combined weight of occupants and cargo should never exceed XXX kg or XXX lbs." on your vehicle's Tire and Loading Information placard.
- ▶ **Step 2:** Determine the combined weight of the driver and passengers that will be riding in your vehicle.
- ▶ **Step 3:** Subtract the combined weight of the driver and passengers from XXX kilograms or XXX lbs.
- ▶ **Step 4:** The resulting figure equals the available amount of cargo and luggage load capacity. For example, if the "XXX" amount equals 1400 lbs and there will be five 150 lb passengers in your vehicle, the amount of available cargo and luggage load capacity is 650 lbs (1400 - 750 (5 x 150) = 650 lbs).
- ▶ **Step 5:** Determine the combined weight of luggage and cargo being loaded on the vehicle. That weight may not safely exceed the available cargo and luggage load capacity calculated in step 4.
- ▶ **Step 6 (if applicable):** If your vehicle will be towing a trailer, load from your trailer will be transferred to your vehicle. Consult this manual to determine how this reduces the available cargo and luggage load capacity of your vehicle (▷ page 263).

Example: steps 1 to 3

The following table shows examples on how to calculate total load and cargo capacities with varying seating configurations and number and size of occupants. The following examples use a load limit of 1500 lbs (680 kg). **This is for illustration purposes only.** Make sure you are using the actual load limit for your vehicle stated on the vehicle's Tire and Loading Information placard (▷ page 260).

		Example 1	Example 2
Step 1	Combined maximum weight of occupants and cargo (data from the Tire and Loading Information placard)	1500 lbs (680 kg)	1500 lbs (680 kg)

		Example 1	Example 2
Step 2	Number of people in the vehicle (driver and occupants)	1	2
	Weight of the occupants	Occupant 1: 175 lbs (80 kg)	Occupant 1: 175 lbs (80 kg) Occupant 2: 195 lbs (88 kg)
	Gross weight of all occupants	175 lbs (80 kg)	370 lbs (168 kg)

		Example 1	Example 2
Step 3	Permissible cargo and trailer load/noseweight (maximum gross vehicle weight rating from the Tire and Loading Information placard minus the gross weight of all occupants)	1500 lbs (680 kg) - 175 lbs (80 kg) = 1325 lbs (600 kg)	1500 lbs (680 kg) - 370 lbs (168 kg) = 1130 lbs (512 kg)

The higher the weight of all the occupants, the smaller the maximum load for luggage. Further information can be found under "Towing a trailer" (▷ page 263).

Vehicle identification plate

Even if you have calculated the total load carefully, you should still make sure that the gross vehicle weight rating and the gross axle

weight rating are not exceeded. Details can be found on the vehicle identification plate on the B-pillar on the driver's side of the vehicle (▷ page 259).

Gross vehicle weight: the gross weight of the vehicle, all passengers, cargo and trailer load/noseweight (if applicable) must not exceed the permissible gross vehicle weight.

Gross axle weight rating: the maximum permissible weight that can be carried by one axle (front or rear axle).

To ensure that your vehicle does not exceed the maximum permissible values (gross vehicle weight and maximum gross axle weight rating), have your loaded vehicle (including driver, occupants, cargo, and full trailer load if applicable) weighed on a suitable vehicle weighbridge.

Trailer load/noseweight

The trailer load/noseweight affects the gross weight of the vehicle. If a trailer is attached, the trailer load/noseweight is included in the load along with occupants and luggage. The trailer load/noseweight is usually approximately 10% of the gross weight of the trailer and its load.

Your Mercedes-Benz has been designed primarily to carry passengers and their luggage. Mercedes-Benz does not recommend towing a trailer with your vehicle.

Maximum load rating

WARNING

Do not overload the tires by exceeding the specified load limit as indicated on the Tire and Loading Information placard on the driver's door B-pillar. Overloading the tires can overheat them, possibly causing a blowout. Overloading the tires can also result in handling or steering problems, or brake failure.

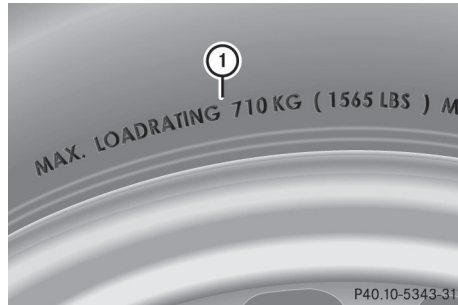

i The actual values for tires are vehicle-specific and may deviate from the values in the illustration.

Maximum tire load ① is the maximum permissible weight for which the tire is approved.

Further information on tire loads (▷ page 265).

Uniform Tire Quality Grading Standards

Overview of Tire Quality Grading Standards

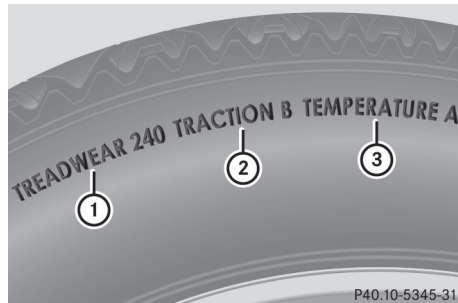

Uniform Tire Quality Grading Standards are U.S. government specifications. Their purpose is to provide drivers with uniform reliable information on tire performance data. Tire manufacturers have to grade tires using three performance factors: tread wear ①, tire traction ②, and heat resistance ③. All tires sold in North America are provided with the corresponding quality class mark on the

sidewall of the tire, even though these regulations do not apply to Canada.

- i** The actual values for tires are vehicle-specific and may deviate from the values in the illustration.

Where applicable, the tire grading information can be found on the tire sidewall between the tread shoulder and maximum tire width.

For example:

Tread wear	Traction	Temperature
200	AA	A

All passenger car tires must conform to the statutory safety requirements in addition to these grades.

Tires and wheels

Tread wear

The tread wear grade is a comparative rating based on the wear rate of the tire when tested under controlled conditions on a specified U.S. government course. For example, a tire graded 150 would wear one and one-half times as well on the government test track as a tire graded 100.

The relative performance of tires depends upon the actual conditions of their use, however, and may depart significantly from the norm, due to variations in driving habits, service practices and differences in road characteristics and climate conditions.

Traction

WARNING

The traction grade assigned to this tire is based on straight-ahead braking traction tests, and does not include acceleration, cornering, hydroplaning, or peak traction characteristics.

The traction grades, from highest to lowest, are AA, A, B, and C. Those grades represent

the tire's ability to stop on a wet surface as measured under controlled conditions on specified government test surfaces of asphalt and concrete. A tire marked C may have poor traction performance.

WARNING

If ice has formed on the road, tire traction will be substantially reduced. Under such weather conditions, drive, steer and brake with extreme caution.

The safe speed on a wet, snow covered or icy road is always lower than on dry road surfaces.

You should pay special attention to road conditions when temperatures are around freezing point.

Mercedes-Benz recommends a minimum tire tread depth of $\frac{1}{8}$ in (4 mm) for all four winter tires (> page 252) to maintain normal driving characteristics in winter. Winter tires can reduce the braking distance on snow-covered surfaces in comparison with summer tires. The braking distance is still much further than on surfaces that are not icy or covered with snow. Take appropriate care when driving.

- !** Avoid wheelspin. This can lead to damage to the drive train.

Temperature

WARNING

The temperature grade for this tire is established for a tire that is properly inflated and not overloaded. Excessive speed, underinflation, or excessive loading, either separately or in combination, can cause excessive heat build-up and possible tire failure.

The temperature grades are A (the highest), B, and C. These represent the tire's resistance to the generation of heat and its ability to dissipate heat when tested under controlled conditions on a specified indoor

laboratory test wheel. Sustained high temperature can cause the material of the tire to degenerate and reduce tire life, and excessive temperature can lead to sudden tire failure. The grade C corresponds to a level of performance which all passenger car tires must meet under the Federal Motor Vehicle Safety Standard No. 109. Grades B and A represent higher levels of performance on the laboratory test wheel than the minimum required by law.

Tire labeling

Tire labeling overview

The following markings are on the tire in addition to the tire name (sales designation) and the manufacturer's name:

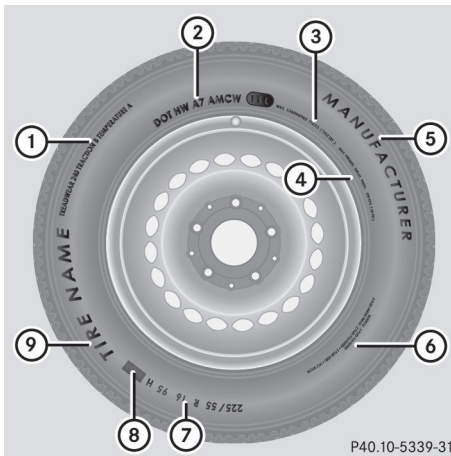

- ① Uniform Tire Quality Grading Standard (▷ page 269)
- ② DOT, Tire Identification Number (▷ page 268)
- ③ Maximum tire load (▷ page 263)
- ④ Maximum tire pressure (▷ page 256)
- ⑤ Manufacturer
- ⑥ Tire material (▷ page 268)
- ⑦ Tire size designation, load-bearing capacity and speed rating (▷ page 265)

- ⑧ Load index (▷ page 267)
- ⑨ Tire name

i Tire data is vehicle-specific and may deviate from the data in the example.

Tire size designation, load-bearing capacity and speed rating

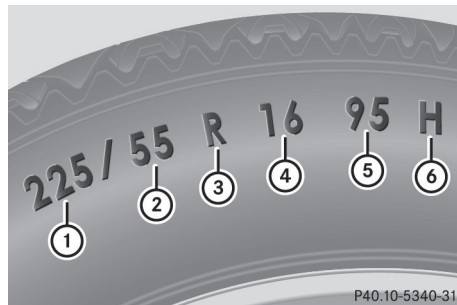

- ① Tire width
- ② Nominal aspect ratio in %
- ③ Tire code
- ④ Rim diameter
- ⑤ Load bearing index
- ⑥ Speed rating

i Tire data is vehicle-specific and may deviate from the data in the example.

General: depending on the manufacturer's standards, the size imprinted in the tire wall may not contain any letters or may contain one letter that precedes the size description.

If there is no letter preceding the size description (as shown above): these are passenger vehicle tires according to European manufacturing standards.

If "P" precedes the size description: these are passenger vehicle tires according to U.S. manufacturing standards.

If "LT" precedes the size description: these are light truck tires according to U.S. manufacturing standards.

If "T" precedes the size description: these are compact emergency spare wheels at high tire

pressure, to be used only temporarily in an emergency.

Tire width: tire width ① shows the nominal tire width in millimeters.

Nominal aspect ratio: aspect ratio ② is the ratio between the tire height and tire width and is shown as a percentage. The aspect ratio is calculated by dividing the tire width by the tire height.

Tire code: tire code ③ specifies the tire type. "R" represents radial tires; "D" represents diagonal tires; "B" represents diagonal radial tires.

Optionally, tires with a maximum speed of over 149 mph (240 km/h) may have "ZR" in the size description depending on the manufacturer (e.g. 245/40 ZR 18).

Rim diameter: rim diameter ④ is the diameter of the bead seat, not the diameter of the rim flange. The rim diameter is specified in inches (in).

Load bearing index: load bearing index ⑤ is a numerical code which specifies the maximum load-bearing capacity of a tire.

WARNING

The tire load rating must always be at least half of the GAWR of your vehicle. Otherwise, sudden tire failure may be the result which could cause an accident and/or serious injury to you or others.

Always replace rims and tires with rims and tires having the same specifications (designation, manufacturer and type) as shown on the original part.

WARNING

Do not overload the tires by exceeding the specified load limit as indicated on the Tire and Loading Information placard on the driver's door B-pillar. Overloading the tires can overheat them, possibly causing a blowout. Overloading the tires can also result in handling or steering problems, or brake failure.

Example:

The load bearing index 91 is equivalent to a maximum load of 1356 lbs (615 kg) that the tire can carry. For further information on the maximum tire load in kilograms and pounds, see (▷ page 263).

For further information on the load bearing index, see Load index (▷ page 267).

Speed rating: speed rating ⑥ specifies the approved maximum speed of the tire.

WARNING

Even when permitted by law, never operate a vehicle at speeds greater than the maximum speed rating of the tires.

Exceeding the maximum speed for which tires are rated can lead to sudden tire failure, causing loss of vehicle control and possibly resulting in an accident and/or serious personal injury and possible death, for you and for others.

Regardless of the speed rating, always observe the speed limits. Drive carefully and adapt your driving style to the traffic conditions.

Summer tires

Index	Speed rating
Q	Up to 100 mph (160 km/h)
R	Up to 106 mph (170 km/h)
S	Up to 112 mph (180 km/h)
T	Up to 118 mph (190 km/h)
H	Up to 130 mph (210 km/h)
V	Up to 149 mph (240 km/h)
W	Up to 168 mph (270 km/h)
Y	Up to 186 mph (300 km/h)
ZR...Y	Up to 186 mph (300 km/h)
ZR...(..Y)	Above 186 mph (300 km/h)
ZR	Above 149 mph (240 km/h)

- Optionally, tires with a maximum speed of over 149 mph (240 km/h) may have "ZR" in the size description depending on the manufacturer (e.g. 245/40 ZR 18).

The service specifications consist of load bearing index ⑤ and speed rating ⑥.

- If the size description of your tire includes "ZR" and there are no service specifications, ask the tire manufacturer in order to find out the maximum speed.

If a service specification is available, the maximum speed is limited according to the speed rating in the service specification. Example: 245/40 ZR 18 97 Y. In this example, "97 Y" is the service specification. The letter "Y" represents the speed rating, and the maximum speed of the tire is limited to 186 mph (300 km/h).

- Every tire that has a maximum speed above 186 mph (300 km/h) must have "ZR" in the size description **and** the service specification must be given in brackets. Example: 275/40 ZR 18 (99 Y). The speed rating "(Y)" shows that the maximum speed of the tire is above 186 mph (300 km/h). Ask the tire manufacturer about the maximum speed.

All-weather tires and winter tires

Index	Speed rating
Q M+S ¹⁸	Up to 100 mph (160 km/h)
T M+S ¹⁸	Up to 118 mph (190 km/h)
H M+S ¹⁸	Up to 130 mph (210 km/h)
V M+S ¹⁸	Up to 149 mph (240 km/h)

- i** Not all tires that have the M+S identification offer the driving characteristics of winter tires. In addition to the M+S marking, winter tires also have the ❄️ snowflake symbol on the tire wall. Tires with this identification fulfill the requirements of the Rubber Manufacturers

Association (RMA) and the Rubber Association of Canada (RAC) regarding the tire traction on snow and have been especially developed for driving on snow.

The speed rating of tires mounted at the factory may be higher than the maximum speed that the electronic speed limiter permits.

Make sure that your tires have the required speed rating as specified in the "Tires" section (> page 272), e.g. if you buy new tires.

Further information about reading tire data can be obtained from any qualified specialist workshop.

Load index



- i** Tire data is vehicle-specific and may deviate from the data in the example.

In addition to the load-bearing index, load index ① may be imprinted after the letters that identify speed rating ⑥ (> page 265) on the sidewall of the tire.

- If no specification is given: no text (as in the example above), represents a standard load (SL) tire
- XL or Extra Load: represents a reinforced tire
- Light Load: represents a light load tire
- C, D, E: represents a load range that depends on the maximum load that the tire can carry at a certain pressure

¹⁸ Or M+S ❄️ for winter tires.

DOT, Tire Identification Number (TIN)

U.S. tire regulations prescribe that every manufacturer of new tires or retreader has to imprint a TIN in or on the sidewall of each tire produced.

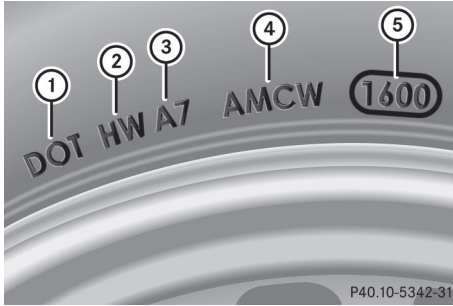

The TIN is a unique identification number. The TIN enables tire manufacturers to inform purchasers of recalls and other safety-relevant matters. It makes it possible for the purchaser to easily identify the affected tires. The TIN is made up of manufacturer identification code ②, tire size ③, tire type code ④ and manufacturing date ⑤.

- ① Tire data is vehicle-specific and may deviate from the data in the example.

DOT (Department of Transportation): tire symbol ① indicates that the tire complies with the requirements of the U.S. Department of Transportation.

Manufacturer identification code: manufacturer identification code ② provides details on the tire manufacturer. New tires have a code with two symbols.

Tire size: identifier ③ describes the tire size.

Tire type code: tire type code ④ can be used by the manufacturer as a code to describe specific characteristics of the tire.

Date of manufacture: date of manufacture ⑤ provides information about the age of a tire. The first and second positions represent the week of manufacture, starting with "01" for the first calendar week. Positions three and four represent the year of manufacture.

For example, a tire that is marked with "3208" was manufactured in week 32 in 2008.

Tire characteristics

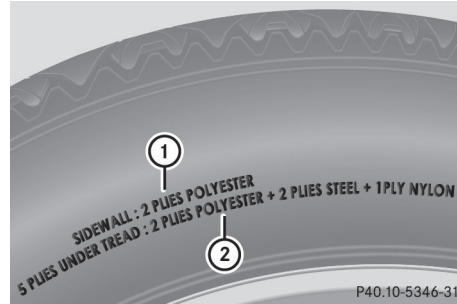

- ① Tire data is vehicle-specific and may deviate from the data in the example.

This information describes the tire cord and the number of layers in sidewall ① and under tire tread ②.

Definition of terms for tires and loading

Tire ply composition and material used

Describes the number of plies or the number of layers of rubber-coated fabric in the tire tread and sidewall. These are made of steel, nylon, polyester and other materials.

Bar

Metric unit for tire pressure. There are 14.5038 pounds per square inch (psi) to 1 bar; there are 100 kilopascals (kPa) to 1 bar.

DOT (Department of Transportation)

DOT marked tires fulfill the requirements of the United States Department of Transportation.

Normal occupant weight

The number of occupants the vehicle is designed to seat, multiplied by 68 kilograms (150 lbs).

Uniform Tire Quality Grading Standards

A uniform standard to grade the quality of tires with regards to tread quality, tire traction and temperature characteristics. The quality grading assessment is made by the manufacturer following specifications from the U.S. government testing procedures. The ratings are molded into the sidewall of the tire.

Recommended tire pressure

The recommended tire pressure for your vehicle under normal driving conditions. You will find the recommendation on the Tire and Loading Information placard on the B-pillar on the driver's side of your vehicle. The recommended tire pressure provides the best balance between handling characteristics, ride comfort and wear. Supplemental information pertaining to special driving situations can be found on the tire inflation pressure label on the inside of the fuel filler flap.

Increased vehicle weight due to optional equipment

This is the combined weight of all standard and optional equipment available for the vehicle, regardless of whether it is actually installed on the vehicle or not.

Rim

This is the part of the wheel on which the tire is mounted.

GAWR (Gross Axle Weight Rating)

The GAWR is the maximum gross axle weight rating. The actual load on an axle must never exceed the gross axle weight rating. The gross axle weight rating can be found on the vehicle identification plate on the B-pillar on the driver's side.

Speed rating

The speed rating is part of the tire identification. It specifies the speed range for which the tire is approved.

GVW (Gross Vehicle Weight)

The gross vehicle weight includes the weight of the vehicle including fuel, tools, the spare wheel, accessories installed, occupants, luggage and the drawbar noseweight, if applicable. The gross vehicle weight must not exceed the gross vehicle weight rating (GVWR) as specified on the vehicle identification plate on the B-pillar on the driver's side.

GVWR (Gross Vehicle Weight Rating)

The GVWR is the maximum permitted gross weight of the fully laden vehicle (weight of the vehicle including all accessories, occupants, fuel, luggage and the drawbar noseweight if applicable). The gross vehicle weight rating is specified on the vehicle identification plate on the B-pillar on the driver's side.

Maximum loaded vehicle weight

The maximum weight is the sum of the curb weight of the vehicle, the weight of the accessories, the total load limit and the weight of the optional equipment installed at the factory.

Kilopascal (kPa)

Metric unit for tire pressure. 6.9 kPa is the equivalent of 1 psi. Another unit for tire pressure is bar. There are 100 kilopascals (kPa) to 1 bar.

Load index

In addition to the load-bearing index, the load index may also be imprinted on the sidewall of the tire. This specifies the load-bearing capacity more precisely.

Curb weight

The weight of a vehicle with standard equipment including the maximum capacity of fuel, oil and coolant. It also includes the air-conditioning system and optional equipment if these are installed in the vehicle, but does not include passengers or luggage.

Maximum load rating

The maximum load rating in kilograms or pounds is the maximum weight for which a tire is approved.

Maximum permissible tire pressure

Maximum permissible tire pressure for one tire.

Maximum load on one tire

Maximum load on one tire. This is calculated by dividing the maximum axle load of one axle by two.

PSI (pounds per square inch)

A standard unit of measure for tire pressure.

Aspect ratio

Relationship between tire height and tire width in percent.

Tire pressure

This is pressure inside the tire applying an outward force to each square inch of the tire's surface. The tire pressure is specified in pounds per square inch (psi), in kilopascal (kPa) or in bar. The tire pressure should only be corrected when the tires are cold. For this, the vehicle must have been stationary for at least three hours or not have traveled more than 1.6 km (1 mile) in this time.

Tire pressure of cold tires

The tires are cold:

- if the vehicle has been parked without direct sunlight on the tires for at least three hours and
- if the vehicle has not been driven more than 1 mile (1.6 km)

Tread

The part of the tire that comes into contact with the road.

Bead

The tire bead ensures that the tire sits securely on the wheel. There are several steel wires in the bead to prevent the tire from coming loose from the wheel rim.

Sidewall

The part of the tire between the tread and the bead.

Weight of optional extras

The combined weight of those optional extras that weigh more than the replaced standard part and more than 2.3 kilograms (5 lbs). These optional extras, such as high-performance brakes, level control, a roof rack or a high-voltage battery, are not included in the curb weight and the weight of the accessories.

TIN (Tire Identification Number)

This is a unique identifier which can be used by a tire manufacturer to identify tires, for example for a product recall, and thus identify the purchasers. The TIN is made up of the manufacturer's identity code, tire size, tire type code and the manufacturing date.

Load bearing index

The load bearing index (also load index) is a code that contains the maximum load bearing capacity of a tire.

Traction

Traction is the result of friction between the tires and the road surface.

Treadwear indicators

Narrow bars (tread wear bars) that are distributed over the tire tread. If the tire tread is level with the bars, the wear limit of $\frac{1}{16}$ in (1.6 mm) has been reached.

Occupant distribution

The distribution of occupants in a vehicle at their designated seating positions.

Total load limit

Rated cargo and luggage load plus 68 kilograms (150 lbs) times the vehicle's designated seating capacity.

Changing a wheel

Flat tire

The "Roadside Assistance" section (▷ page 233) contains information and notes on how to deal with a flat tire. It also provides instructions on changing a wheel or mounting the spare wheel/emergency spare wheel.

Interchanging the wheels

WARNING

Rotate front and rear wheels only if the tires are of the same dimension.

If your vehicle is equipped with mixed-size tires (different tire dimensions front vs. rear), tire rotation is not possible.

WARNING

Have the tightening torque checked after changing a wheel. Wheels could become loose if not tightened with a torque of 96 lb-ft (130 Nm).

Only use genuine Mercedes-Benz wheel bolts specified for your vehicle's rims.

The wear patterns on the front and rear tires differ, depending on the operating conditions. Rotate the wheels before a clear wear pattern has formed on the tires. Front tires typically wear more on the shoulders and the rear tires in the center.

If your vehicle's tire configuration allows, you can rotate the wheels according to the intervals in the tire manufacturer's warranty book in your vehicle documents. If this is not available, the tires should then be replaced every 3000 to 6000 miles (5000 to 10,000 km), or earlier if the tire wear

requires this. Do not change the direction of wheel rotation.

Clean the contact surfaces of the wheel and the brake disc thoroughly every time a wheel is interchanged. Check the tire pressures.

For information on changing tires and mounting the spare wheel, see (▷ page 236).

! On vehicles equipped with a tire pressure monitor, electronic components are located in the wheel.

Tire-mounting tools should not be used near the valve. This could damage the electronic components.

Only have tires changed at a qualified specialist workshop.

Direction of rotation

Tires with a specified direction of rotation have additional benefits, e.g. if there is a risk of hydroplaning. You will only gain these benefits if the correct direction of rotation is maintained.

An arrow on the sidewall of the tire indicates its correct direction of rotation.

You may mount a spare wheel/emergency spare wheel against the direction of rotation. Observe the time restriction on use as well as the speed limitation specified on the spare wheel/emergency spare wheel.

Storing wheels

Store wheels that are not being used in a cool, dry and preferably dark place. Protect the tires from oil, grease, gasoline and diesel.

Cleaning the wheels

WARNING

Do not use power washers with circular-jet nozzles (dirt grinders) to clean your vehicle, in particular the tires. You could otherwise damage the tires and cause an accident.

Wheel and tire combinations

Please bear the following in mind

! For safety reasons, Mercedes-Benz recommends that you only use Tires and wheels which have been approved by Mercedes-Benz specifically for your vehicle.

These tires have been specially adapted for use with the control systems, such as ABS or ESP®, and are marked as follows:

- MO = Mercedes-Benz Original
- MOE = Mercedes-Benz Original Extended (tires featuring run-flat characteristics)
- MO1 = Mercedes-Benz Original (only certain AMG tires)

Mercedes-Benz Original Extended tires may only be used on wheels that have been specifically approved by Mercedes-Benz.

Only use tires, wheels or accessories tested and approved by Mercedes-Benz. Certain characteristics, e.g. handling, vehicle noise emissions or fuel consumption, may otherwise be adversely affected. In addition, when driving with a load, tire dimension variations could cause the tires to come into contact with the bodywork and axle components. This could result in damage to the tires or the vehicle.

Mercedes-Benz accepts no liability for damage resulting from the use of tires, wheels or accessories other than those tested and approved.

Further information about tires, wheels and approved combinations can be obtained from any authorized Mercedes-Benz Center.

i The Tire and Load Information placard with the recommended tire pressures is on the B-pillar on the driver's side. Further information about driving at high speeds or driving with vehicle loads that are lighter than the maximum vehicle load can be found in the tire pressure table on the inside of the fuel filler flap. Check tire

pressures regularly, and only when the tires are cold. Comply with the maintenance recommendations of the tire manufacturer. These are located in the vehicle document wallet.

For further information on the recommended tire inflation pressure and on tire pressures for specific driving conditions (▷ page 253).

i Notes on the vehicle equipment – always equip the vehicle:

- with tires of the same size on a given axle (left/right)
- with the same type of tires on all wheels at a given time (summer tires, winter tires)

i The following pages contain information on approved wheel rims and tire sizes for equipping your vehicle with winter tires. Winter tires are not available ex factory as standard equipment or optional extras.

If you wish to equip your vehicle with approved winter tires, you will also require, in certain circumstances, wheel rims of an appropriate size, as the sizes of approved winter tires can deviate from those of standard tires. This is dependent on the model and the equipment installed at the factory.

The tires and wheel rims, as well as further information, can be obtained at a qualified specialist workshop.

Tires

Summer tires

Front axle	
Summer tires	265/35 ZR19 (98Y) XL
Light alloy rim	9.5J x 19 H2 ET 60 or 9.5J x 19 H2 ET 59
Rear axle	
Summer tires ¹⁹	295/30 ZR20 (101Y) XL
Light alloy rim	11J x 20 H2 ET 68

Winter tires, variant 1

Front axle	
Winter tires	265/35 R19 98W XL M+S
Light alloy rim	9.5J x 19 H2 ET 60 or 9.5J x 19 H2 ET 59
Rear axle	
Winter tires ¹⁹	295/30 R20 101W XL M+S
Light alloy rim	11J x 20 H2 ET 68

Winter tires, variant 2

Front and rear axles	
Winter tires	255/35 R19 96V XL M+S
Light alloy rim	9.5J x 19 H2 ET 59

¹⁹ Snow chains not permitted.

Useful information	276
Notes on technical data	276
Genuine Mercedes-Benz parts	276
Warranty	277
Identification plates	277
Service products and filling capacities	278
Vehicle data, Coupe	284
Vehicle data, Roadster	284

Useful information

- i** This Operator's Manual describes all models and all standard and optional equipment of your vehicle available at the time of publication of the Operator's Manual. Country-specific differences are possible. Please note that your vehicle may not be equipped with all features described. This also applies to safety-related systems and functions.
- i** Please read the information on qualified specialist workshops (▷ page 21).

Notes on technical data

- i** The technical data was determined in accordance with EC Directives. All data applies to the vehicle's standard equipment. The data may therefore differ for vehicles with optional equipment. You can obtain further information from an authorized Mercedes-Benz Center.

You can find technical data on the Internet at: <http://www.mercedes-benz.com>

Genuine Mercedes-Benz parts

WARNING

Driving safety may be impaired if non-approved parts, tires and wheels or safety-relevant accessories are used.

This could lead to malfunctions in safety-relevant systems, e.g. the brake system. This could cause you to lose control of your vehicle and cause an accident.

For this reason, Mercedes-Benz recommends that you use genuine Mercedes-Benz parts or parts of equal quality. Only use tires, wheels and accessories that have been specifically approved for your vehicle.

Environmental note

Daimler AG also supplies reconditioned major assemblies and parts which are of the same quality as new parts. They are covered by the same Limited Warranty entitlements as new parts.

- !** Air bags and Emergency Tensioning Devices, as well as control units and sensors for these restraint systems may be installed in the following areas of your vehicle:

- doors
- door pillars
- door sills
- seats
- dashboard
- instrument cluster
- center console

Do not install accessories such as audio systems in these areas. Do not carry out repairs or welding. You could impair the operating efficiency of the restraint systems.

Have aftermarket accessories installed at a qualified specialist workshop. Mercedes-Benz recommends that you use an authorized Mercedes-Benz Center for this purpose.

All Mercedes-Benz Centers maintain a supply of genuine Mercedes-Benz parts for necessary service and repair work. In addition, strategically located parts delivery centers provide quick and reliable parts service.

More than 300,000 different genuine Mercedes-Benz parts are available for Mercedes-Benz models.

Genuine Mercedes-Benz parts are subject to strict quality control. Each part has been specially developed, manufactured or selected for Mercedes-Benz vehicles and fine-tuned for them.

Only genuine Mercedes-Benz parts should therefore be used.

Always specify the vehicle identification number (VIN) (▷ page 277) and the engine number (▷ page 278) when ordering genuine Mercedes-Benz parts.

Warranty

The Service and Warranty Information booklet contains detailed information about the warranties covering your vehicle. Your authorized Mercedes-Benz Center will exchange or repair any defective parts originally installed in the vehicle in accordance with the terms of the following warranties:

- New Vehicle Limited Warranty
- Emission System Warranty
- Emission Performance Warranty
- California, Connecticut, Maine, Massachusetts, New York, Pennsylvania, Rhode Island and Vermont Emission Control System Warranty
- State warranty enforcement laws (Lemon Laws)

Replacement parts and accessories are covered by the Mercedes-Benz Parts and Accessories warranties. You can obtain information about this from any authorized Mercedes-Benz Center.

- ❗ Should you lose your Service and Warranty Information booklet, have an authorized Mercedes-Benz Center arrange for a replacement. It will be mailed to you.

Identification plates

Vehicle identification plate with vehicle identification number (VIN) and paint code number

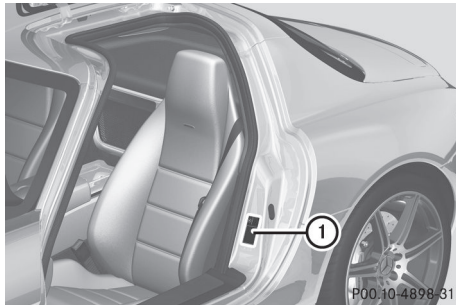

- ▶ Open the driver's door. You will see vehicle identification plate ①.

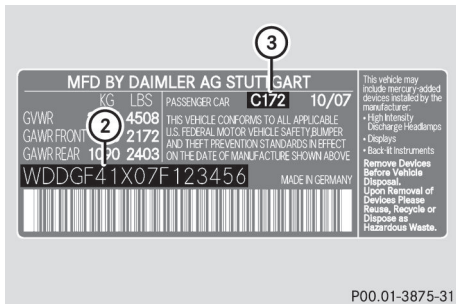

- Example: vehicle identification plate (USA only)
- ② VIN
- ③ Paint code

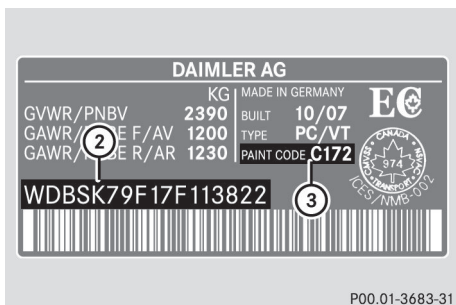

- Example: vehicle identification plate (Canada only)
- ② VIN
- ③ Paint code

- i** The data shown on the identification plate is example data. This data is different for every vehicle and can deviate from the data shown here. You can find the data applicable to your vehicle on the vehicle's identification plate.

Vehicle identification number (VIN)

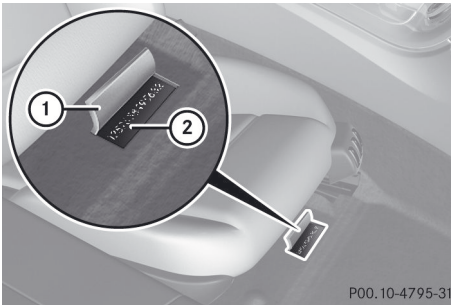

- ▶ Slide the right-hand front seat to its rearmost position.
- ▶ Fold floor covering ① upwards. You will see vehicle identification number (VIN) ②.

Additionally, the vehicle identification number (VIN) can be found in the following locations:

- on the vehicle identification plate (> page 277)
- on the lower edge of the windshield (> page 278)

Engine number

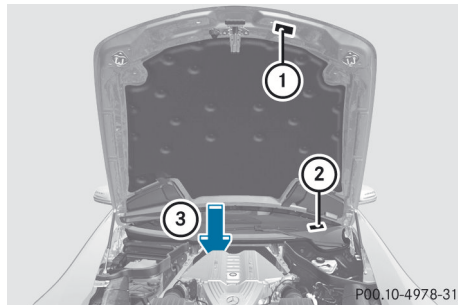

- ① Emission control information plate, including the certification of both federal and Californian emissions standards
- ② VIN (on the lower edge of the windshield)
- ③ Engine number (stamped into the crankcase)

Service products and filling capacities

Important safety notes

Service products include the following:

- fuels
- lubricants (e.g. engine oil, transmission oil)
- coolant
- brake fluid
- windshield washer fluid

Vehicle components and their respective lubricants must match. Therefore only use products tested and approved by Mercedes-Benz.

Information on tested and approved products can be obtained at a Mercedes-Benz Center.

⚠ WARNING

Comply with all valid regulations with respect to handling, storing and disposing of service fluids. Otherwise, you could endanger persons or the environment.

Keep service fluids out of the reach of children.

For health reasons, you should prevent service fluids from coming into direct contact with your skin or clothing.

If a service fluid is swallowed, contact a physician immediately.

Filling capacities		
	Capacity	Fuel, coolant, lubricants, etc.
Engine oil and filter	8.43 US qt (7.98 l)	Approved engine oils
AMG SPEEDSHIFT DCT 7-speed sports transmission, hydraulic chamber	7.4 US qt (7.0 l) + 0.85 US qt (0.8 l) for oil cooler and hose lines at the first filling	Shell DCT F.3
AMG SPEEDSHIFT DCT 7-speed sports transmission, gear set, drive set and differential chamber	3.06 US qt (2.9 l) + 0.87 US qt (0.82 l) for oil cooler and hose lines at the first filling	Shell GL.5
Power steering	1.26 US qt (1.2 l)	Chevron Texaco CHF 9109
Brake system	Approximately 0.53 US qt (0.5 l)	MB Brake Fluid (DOT 4+)
Cooling system	Approximately 11.6 US qt (11.0 l)	MB 325.0 corrosion inhibitor/antifreeze agent
Tank capacity	22.5 US gal (85.0 l)	Premium-grade unleaded gasoline (at least 91 octane, average value between 96 RON/86 MON)
Reserve	Approximately 3.7 US gal (14.0 l)	
Automatic climate control	—	Refrigerant R134a and special PAG lubricant (never R 12)
Windshield/headlamp cleaning system	6.3 US qt (6.0 l)	MB windshield washer concentrate ²⁰ (▷ page 284) Mixing ratio for washer fluid (▷ page 284)

Fuel

Important safety notes

WARNING

Gasoline is highly flammable and poisonous. It burns violently and can cause serious personal injury.

Never allow sparks, flames or smoking materials near gasoline.

Turn off the engine before refueling.

Whenever you are around gasoline, avoid inhaling fumes and any skin or clothing contact.

²⁰ Mixed with water or premixed washer fluid with antifreeze protection.

Direct skin contact with fuels and the inhalation of fuel vapors are damaging to your health.

Premium-grade unleaded gasoline

I To ensure the longevity and full performance of the engine, only premium-grade unleaded gasoline must be used.

If premium-grade unleaded gasoline is unavailable and regular gasoline is used, observe the following precautions:

- only fill the fuel tank to half full with regular unleaded gasoline and add the rest as soon as possible with premium-grade unleaded gasoline.
- do not drive at the maximum speed.
- avoid sudden acceleration.
- when the vehicle is carrying a light cargo, e.g. two passengers without luggage, do not allow the engine to rev above 3000 rpm.
- when the vehicle is fully loaded or being operated in mountainous terrain, do not depress the accelerator pedal further than $\frac{2}{3}$ of the pedal travel.

Fuel requirements

Use only premium-grade unleaded gasoline. The octane number should be at least 91. Details can be found on the gas pump. The octane number is the average value of the Research Octane Number (RON) and the Motor Octane Number (MON): $(RON + MON) / 2$, also known as knock resistance. Reformulated Gasoline (RFG) and/or unleaded gasoline with additives can be used. The concentration of additives in the fuel must, however, remain below 10%, such as:

- Ethanol
- TAME
- ETBE
- IPA
- TBA

For MTBE, the concentration should not exceed 15%.

The concentration of methanol, including other additives, in gasoline must not exceed 3%.

Using mixtures of methanol and ethanol is not permitted. Gasohol, a mixture of 10% ethanol and 90% unleaded gasoline, can be used.

All of these mix fuels must fulfill the fuel requirements, e.g.:

- knock resistance
- boiling point
- vapor pressure

Additives in gasoline

One of the major problems in engine design is the creation of carbon deposits during the process of burning fuel. Mercedes-Benz recommends that you use fuel brands containing additives that prevent the build-up of carbon deposits.

If you use fuels without these additives over a longer period of time, carbon deposits may build up. These deposits form at the inlet valves and in the combustion chamber in particular.

This could lead to engine problems, e.g.:

- longer engine warm-up phase
- uneven idle
- engine noise
- misfiring
- loss of power

In areas where the availability of gasoline with relevant additives is not adequate, carbon deposits can form. In this case, Mercedes-Benz recommends the use of additives that have been approved for Mercedes-Benz vehicles.

Consult an authorized Mercedes-Benz Center for a list of approved products. Comply with the instructions for use on the product label. Do not mix other fuel additives with fuel. This causes unnecessary costs and could damage the engine.

- ❗ Do not refuel with low-grade fuel and do not use fuel additives that are not tested and approved for Mercedes-Benz vehicles. Damage to or malfunctions of the fuel system may otherwise occur.

Engine oil

Please bear the following in mind

The engine oils are matched to the performance of Mercedes-Benz engines and service intervals. You should therefore only use engine oils and oil filters that are approved for vehicles with maintenance systems.

For a list of approved engine oils and oil filters, consult an authorized Mercedes-Benz Center.

- ❗ Never use engine oil or an oil filter of a specification other than is necessary to fulfill the prescribed service intervals. Do not change the engine oil or oil filter in order to achieve longer replacement intervals than those prescribed. You could otherwise cause engine damage or damage to the exhaust gas aftertreatment.

Follow the instructions in the service interval display regarding the oil change. Otherwise, you may damage the engine and the exhaust gas aftertreatment.

The table shows which engine oils have been approved for your vehicle.

MB Sheet number	229.5 ²¹
------------------------	---------------------

- i MB approval is indicated on the oil containers.

Additives

- ❗ Do not use any additives in the engine oil. This could damage the engine.

Engine oil viscosity

Viscosity describes the flow characteristics of a fluid. If an engine oil has a high viscosity, this means that it is thick; a low viscosity means that it is thin.

Select an engine oil with an SAE (viscosity) classification suitable for the prevailing outside temperatures. The following table shows the correct SAE classification to be used. The low-temperature characteristics of engine oils can deteriorate significantly, e.g. as a result of aging, soot and fuel deposits. It is therefore strongly recommended that you carry out regular oil changes using an approved engine oil with the appropriate SAE classification.

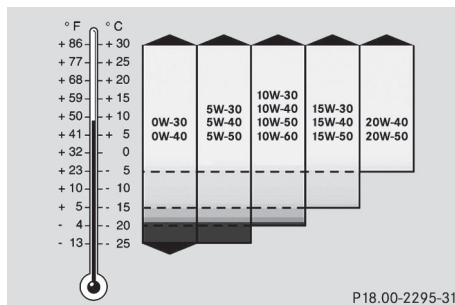

Refrigerant of the air-conditioning system

The automatic climate control is filled with R134a refrigerant and a special PAG lubricant.

- ❗ Never use refrigerant R 12 (CFC) or mineral lubricants. Otherwise, you could damage the air-conditioning system.

Brake fluid

⚠ WARNING

The brake fluid constantly absorbs moisture from the air; this lowers its boiling point.

²¹ Restriction: use only SAE 0W-40/SAE 5W-40 engine oils.

If the boiling point of the brake fluid is too low, vapor pockets may form in the brake system when the brakes are applied hard (e.g. when driving downhill). This would impair braking efficiency.

You should have the brake fluid renewed at regular intervals. The brake fluid change intervals can be found in the Maintenance Booklet.

Only use brake fluid approved by Mercedes-Benz. Information about approved brake fluids can be obtained from any authorized Mercedes-Benz Center.

Coolant

Important safety notes

The coolant is a mixture of water and antifreeze/corrosion inhibitor. It performs the following tasks:

- anti-corrosion protection
- antifreeze protection
- raising the boiling point

The engine cooling system is filled at the factory with coolant which contains an antifreeze/corrosion inhibitor that ensures protection down to approximately -35 °F (-37 °C).

! Only add coolant that has been premixed with the desired antifreeze protection. You could otherwise damage the engine.

Further information on coolants and on filling can be found in the Mercedes-Benz Specifications for Service Products, MB Approval 310.1, e.g. on the Internet at <http://bevo.mercedes-benz.com>. You can also consult an authorized Mercedes-Benz Center.

If the coolant has antifreeze protection down to -35 °F (-37 °C), the boiling point of the coolant in the pressurized system is approximately 266 °F (130 °C).

Your vehicle has a range of aluminum components. Aluminum components in the engine make it necessary to use anticorrosion/antifreeze coolant which has been specifically formulated to protect the aluminum parts. Using other antifreeze/corrosion inhibitors without these characteristics affects the service life.

The coolant must be used throughout the year in order to maintain the necessary corrosion protection and provide protection from overheating. In the Maintenance Booklet, you can find information on the intervals for renewal.

The renewal interval is determined by the coolant type and the engine cooling system design. The renewal interval in the Maintenance Booklet is only valid if the coolant is renewed or replenished with Mercedes-Benz approved products.

Therefore, only use MB 325.0 antifreeze/corrosion inhibitor or another Mercedes-Benz approved product of the same specification.

Information on other products with the same specifications that are approved by Mercedes-Benz can be obtained at an authorized Mercedes-Benz Center or on the Internet at

<http://bevo.mercedes-benz.com>.

The coolant is checked at every maintenance interval at an authorized Mercedes-Benz Center.

The antifreeze/corrosion inhibitor concentration in the engine cooling system should:

- be at least 50%. This will protect the engine cooling system against freezing down to approximately -35 °F (-37 °C).
- not exceed 55% (antifreeze protection to -49 °F [-45 °C]); otherwise, heat will not dissipate as effectively.

If the coolant level is too low, MB 325.0 antifreeze/corrosion inhibitor should be added. Have the engine cooling system checked for possible leaks.

The water in the engine cooling system must meet minimum requirements, which are usually satisfied by normal drinking water. If you are unsure about the water quality, contact an authorized Mercedes-Benz Center.

Windshield/headlamp cleaning system

WARNING

Washer solvent/antifreeze is highly flammable. Do not spill washer solvent/antifreeze on hot engine parts, because it may ignite and burn. You could be seriously burned.

Use MB SummerFit windshield washer concentrate at temperatures above freezing:

- ▶ Mix 1 part MB SummerFit to 100 parts water (1.34 fl oz[40 ml] to 1 gal[4.0 l] water).

Use freely available premixed windshield washer concentrate at temperatures below freezing:

- ▶ Mix 1 part MB SummerFit to 100 parts windshield washer concentrate (1.34 fl oz[40 ml] to 1 gal[4.0 l] windshield washer concentrate).

Vehicle data, Coupe

The data stated here specifically refers to a vehicle with standard equipment. Consult an authorized Mercedes-Benz Center for the data for all vehicle variants and trim levels.

Vehicle dimensions

Vehicle length	182.7 in (4640 mm)
Vehicle width including exterior mirrors	81.7 in (2075 mm)
Vehicle height	49.7 in (1262 mm)

Vehicle dimensions

Wheelbase	105.5 in (2680 mm)
Front track	66.2 in (1682 mm)
Rear track	65.0 in (1651 mm)
Ground clearance	3.9 in (99 mm)
Turning circle	39.0 ft (11.9 m)

Vehicle weight

Maximum trunk load	137 lb (62 kg)
---------------------------	----------------

Vehicle data, Roadster

The data stated here specifically refers to a vehicle with standard equipment. Consult an authorized Mercedes-Benz Center for the data for all vehicle variants and trim levels.

Vehicle dimensions

Vehicle length	182.7 in (4640 mm)
Vehicle width including exterior mirrors	81.7 in (2075 mm)
Vehicle height	49.6 in (1261 mm)
Wheelbase	105.5 in (2680 mm)
Front track	66.2 in (1682 mm)
Rear track	65.0 in (1651 mm)
Ground clearance	3.9 in (99 mm)
Turning circle	39.0 ft (11.9 m)

Vehicle weight

Maximum trunk load	137 lb (62 kg)
---------------------------	----------------

Publication details

Internet

Further information about Mercedes-Benz vehicles and about Daimler AG can be found on the following websites:

<http://www.mbusa.com> (USA only)

<http://www.mercedes-benz.ca> (Canada only)

Editorial office

Not to be reprinted, translated or otherwise reproduced, in whole or in part, without the written permission of Daimler AG.



1975841081

Order no. 6515 4881 13 Part no. 197 584 10 81 Edition B 2012