



# C-Class Coupe

Operator's Manual



Mercedes-Benz

## Symbols

Registered trademarks:

- Bluetooth® is a registered trademark of Bluetooth SIG Inc.
- DTS is a registered trademark of DTS, Inc.
- Dolby and MLP are registered trademarks of DOLBY Laboratories.
- BabySmart™, ESP® and PRE-SAFE® are registered trademarks of Daimler AG.
- HomeLink® is a registered trademark of Prince.
- iPod® and iTunes® are registered trademarks of Apple Inc.
- Logic 7® is a registered trademark of Harman International Industries.
- Microsoft® and Windows media® are registered trademarks of Microsoft Corporation.
- SIRIUS is a registered trademark of Sirius XM radio Inc.
- HD Radio is a registered trademark of iBiquity Digital Corporation.
- Gracenote® is a registered trademark of Gracenote, Inc.
- ZAGATSurvey® and related brands are registered trademarks of ZagatSurvey, LLC.

In this Operator's Manual, you will find the following symbols:

### **WARNING**

Warning notes draw your attention to hazards that endanger your health or life, or the health or life of others.

 Notes on material damage alert you to dangers that could lead to damage to your vehicle.

 This symbol indicates useful instructions or further information that could be helpful to you.

- ▶ This symbol designates an instruction you must follow.
- ▶ Several consecutive symbols indicate an instruction with several steps.

(▷ page) This symbol tells you where you can find further information on a topic.

▷▷ This symbol indicates a warning or an instruction that is continued on the next page.

**Display** This font indicates a display message in the multifunction display/COMAND display.

Parts of the software in the vehicle are protected by copyright © 2005  
The FreeType Project  
<http://www.freetype.org>. All rights reserved.

## **Welcome to the world of Mercedes-Benz**

Before you drive off, please familiarize yourself with your vehicle and read this manual, especially the safety and warning notes. This will help you to obtain the maximum pleasure from your vehicle and avoid endangering yourself and others.

The equipment or model designation of your vehicle may differ according to:

- model
- order
- country variant
- availability

Mercedes-Benz is constantly updating its vehicles to the state of the art.

Mercedes-Benz therefore reserves the right to introduce changes in the following areas:

- design
- equipment
- technical features

The equipment in your vehicle may therefore differ from that shown in the descriptions and illustrations.

The following are integral components of the vehicle:

- Operator's Manual
- Maintenance Booklet
- Equipment-dependent supplements

Keep these documents in the vehicle at all times. If you sell the vehicle, always pass the documents on to the new owner.

The technical documentation team at Daimler AG wishes you safe and pleasant motoring.

Mercedes-Benz USA, LLC

Mercedes-Benz Canada, Inc.

A Daimler Company

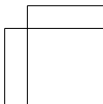
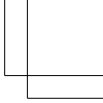
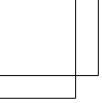



<b>Index</b> .....	<b>4</b>	<b>At a glance</b> .....	<b>27</b>
<b>Introduction</b> .....	<b>20</b>	<b>Safety</b> .....	<b>37</b>
		<b>Opening/closing</b> .....	<b>65</b>
		<b>Seats, steering wheel and mirrors</b> ....	<b>85</b>
		<b>Lights and windshield wipers</b> .....	<b>97</b>
		<b>Climate control</b> .....	<b>113</b>
		<b>Driving and parking</b> .....	<b>123</b>
		<b>On-board computer and displays</b> ....	<b>165</b>
		<b>Stowage and features</b> .....	<b>223</b>
		<b>Maintenance and care</b> .....	<b>245</b>
		<b>Breakdown assistance</b> .....	<b>259</b>
		<b>Wheels and tires</b> .....	<b>275</b>
		<b>Technical data</b> .....	<b>305</b>

- 1, 2, 3 ...**
- 115 V socket** ..... 231
- 12 V socket**  
see Sockets
- 4ETS**  
see ETS/4ETS (Electronic Traction System)
- 4MATIC (permanent four-wheel drive)** ..... 151
- 4MATIC off-road system** ..... 151
- A**
- ABS (Anti-lock Braking System)**  
Display message ..... 186  
Function/notes ..... 59  
Important safety notes ..... 59  
Warning lamp ..... 213
- Activating/deactivating cooling with air dehumidification** ..... 117
- Active service system PLUS**  
see ASSYST PLUS service interval display
- ADAPTIVE BRAKE** ..... 63
- Adaptive Highbeam Assist**  
Display message ..... 198  
Function/notes ..... 102  
Switching on/off (on-board computer) ..... 178
- Additives (engine oil)** ..... 311
- Air bags**  
Display message ..... 193  
Front air bag (driver, front passenger) ..... 41  
Important safety notes ..... 40  
Knee bag ..... 42  
PASSENGER AIR BAG OFF indicator lamp ..... 44  
Pelvis air bag ..... 43  
Safety guidelines ..... 39  
Side impact air bag ..... 42  
Window curtain air bag ..... 44
- Air-conditioning system**  
see Climate control
- Air pressure**  
see Tire pressure
- Air vents**  
Glove box ..... 121  
Important safety notes ..... 120  
Rear ..... 122  
Setting ..... 120  
Setting the center air vents ..... 121  
Setting the side air vents ..... 121
- Alarm system**  
see ATA (Anti-Theft Alarm system)
- Alertness Assistant**  
see ATTENTION ASSIST
- AMG menu (on-board computer)** ..... 181
- Anti-lock Braking System**  
see ABS (Anti-lock Braking System)
- Anti-Theft Alarm system**  
see ATA (Anti-Theft Alarm system)
- Ashtray** ..... 230
- Assistance menu (on-board computer)** ..... 176
- ATA (Anti-Theft Alarm system)**  
Activating/deactivating ..... 64  
Function ..... 64  
Switching off the alarm ..... 64
- ATTENTION ASSIST**  
Activating/deactivating ..... 176  
Display message ..... 201  
Function/notes ..... 159
- Audio menu (on-board computer)** .... 173
- Audio system**  
see separate operating instructions
- Authorized Mercedes-Benz Center**  
see Qualified specialist workshop
- Authorized workshop**  
see Qualified specialist workshop
- AUTO lights**  
Display message ..... 197  
see Lights
- Automatic headlamp mode** ..... 100
- Automatic transmission**  
Automatic drive program ..... 133  
Changing gear ..... 131  
Display message ..... 207  
Driving tips ..... 131  
Emergency running mode ..... 137  
Kickdown ..... 132  
Manual drive program ..... 134  
Problem (malfunction) ..... 137

- Program selector button ..... 132
  - Pulling away ..... 127
  - Releasing the parking lock manually ..... 137
  - Selector lever ..... 130
  - Shift ranges ..... 133
  - Starting the engine ..... 127
  - Steering wheel paddle shifters ..... 133
  - Transmission position display ..... 130
  - Transmission positions ..... 131
  - Automatic transmission emergency mode** ..... 137
- B**
- Back support**  
see Lumbar support
  - Backup lamp**  
Changing bulbs ..... 108  
Display message ..... 197
  - Bag hook** ..... 227
  - BAS (Brake Assist System)** ..... 59
  - Basic settings**  
see Settings
  - Battery (SmartKey)**  
Checking ..... 69  
Important safety notes ..... 69  
Replacing ..... 69
  - Battery (vehicle)**  
Charging ..... 268  
Display message ..... 200  
Important safety notes ..... 266  
Jump starting ..... 269
  - Belt**  
see Seat belts
  - Blind Spot Assist**  
Activating/deactivating ..... 177  
Display message ..... 202  
Notes/function ..... 160
  - Brake Assist System**  
see BAS (Brake Assist System)
  - Brake fluid**  
Display message ..... 189  
Notes ..... 311
  - Brake fluid level** ..... 249
  - Brake lamps**  
Changing bulbs ..... 108  
Display message ..... 196
- Brakes**  
ABS ..... 59  
BAS ..... 59  
Brake fluid (notes) ..... 311  
Display message ..... 186  
Driving tips ..... 143  
High-performance brake system .... 145  
Important safety notes ..... 143  
Maintenance ..... 144  
Parking brake ..... 141  
Warning lamp ..... 212
  - Breakdown**  
see Flat tire  
see Towing away/tow-starting
  - Bulbs**  
see Changing bulbs
- C**
- California**  
Important notice for retail customers and lessees ..... 21
  - Calling up a malfunction**  
see Display messages
  - Car**  
see Vehicle
  - Care**  
Carpets ..... 257  
Car wash ..... 251  
Display ..... 255  
Exterior lights ..... 254  
Gear or selector lever ..... 256  
Interior ..... 255  
Matte finish ..... 253  
Notes ..... 251  
Paint ..... 253  
Plastic trim ..... 255  
Power washer ..... 252  
Rear view camera ..... 255  
Roof lining ..... 257  
Seat belt ..... 257  
Seat cover ..... 256  
Sensors ..... 255  
Steering wheel ..... 256  
Tail pipes ..... 255  
Trim pieces ..... 256  
Washing by hand ..... 252  
Wheels ..... 252

- Windows ..... 253
- Wiper blades ..... 254
- Wooden trim ..... 256
- Cargo tie down rings** ..... 227
- Car wash (care)** ..... 251
- CD player/CD changer (on-board computer)** ..... 174
- Center console**
  - Lower section ..... 33
  - Upper section ..... 32
- Central locking**
  - Automatic locking (on-board computer) ..... 179
  - Locking/unlocking (SmartKey) ..... 66
- Changing bulbs**
  - Brake lamps ..... 108
  - Cornering light function ..... 107
  - High-beam headlamps ..... 106
  - Important safety notes ..... 104
  - Low-beam headlamps ..... 106
  - Overview of bulb types ..... 105
  - Parking lamps ..... 106
  - Reversing lamps ..... 108
  - Standing lamps (front) ..... 106
- Children**
  - In the vehicle ..... 54
  - Restraint systems ..... 54
- Child seat**
  - LATCH-type (ISOFIX) child seat anchors ..... 56
  - Special seat belt retractor ..... 56
  - Top Tether ..... 57
- Cigarette lighter** ..... 230
- Cleaning**
  - Mirror turn signal ..... 254
- Climate control**
  - Controlling automatically ..... 117
  - Cooling with air dehumidification . . 117
  - Defrosting the windows ..... 119
  - Defrosting the windshield ..... 119
  - Dual-zone automatic climate control ..... 115
  - Important safety notes ..... 114
  - Indicator lamp ..... 117
  - Maximum cooling ..... 119
  - Notes on using automatic climate control ..... 116
  - Overview of systems ..... 114
  - Problems with cooling with air dehumidification ..... 117
  - Problem with the rear window defroster ..... 120
  - Setting the air distribution ..... 118
  - Setting the airflow ..... 118
  - Setting the air vents ..... 120
  - Setting the temperature ..... 118
  - Switching air-recirculation mode on/off ..... 120
  - Switching on/off ..... 117
  - Switching the rear window defroster on/off ..... 120
  - Switching the ZONE function on/off ..... 118
- Cockpit**
  - Overview ..... 28
  - see Instrument cluster
- COMAND**
  - see separate operating instructions
- Combination switch** ..... 101
- Compass**
  - Calibrating ..... 242
  - Calling up ..... 242
  - Setting ..... 242
- Consumption statistics (on-board computer)** ..... 171
- Convenience closing feature** ..... 79
- Convenience opening feature** ..... 79
- Coolant (engine)**
  - Checking the level ..... 248
  - Display message ..... 198
  - Filling capacity ..... 312
  - Notes ..... 312
  - Temperature (on-board computer) . 181
  - Temperature gauge ..... 166
  - Warning lamp ..... 218
- Cooling**
  - see Climate control
- Cornering light function**
  - Changing bulbs ..... 107
  - Display message ..... 195
  - Function/notes ..... 102
- Crash-responsive emergency lighting** ..... 104
- Cruise control**
  - Cruise control lever ..... 147
  - Deactivating ..... 148

- Display message ..... 204
  - Driving system ..... 146
  - Function/notes ..... 146
  - Important safety notes ..... 146
  - Setting a speed ..... 147
  - Storing and maintaining current speed ..... 147
  - Cup holder**
    - Center console ..... 229
    - Important safety notes ..... 228
    - Rear compartment ..... 229
  - Customer Assistance Center (CAC)** ... 24
  - Customer Relations Department** ..... 24
- D**
- Dashboard**
    - see Cockpit
  - Data**
    - see Technical data
  - Daytime running lamps**
    - Display message ..... 197
    - Switching on/off (on-board computer) ..... 178
    - Switching on/off (switch) ..... 99
  - Dealership**
    - see Qualified specialist workshop
  - Delayed switch-off**
    - Exterior lighting (on-board computer) ..... 179
    - Interior lighting ..... 179
  - Diagnostics connection** ..... 23
  - Digital speedometer** ..... 171
  - Display (cleaning instructions)** ..... 255
  - Display messages**
    - Calling up (on-board computer) .... 185
    - Driving systems ..... 201
    - Engine ..... 198
    - General notes ..... 185
    - Hiding (on-board computer) ..... 185
    - KEYLESS-GO ..... 209
    - Lights ..... 195
    - Safety systems ..... 186
    - Service interval display ..... 250
    - SmartKey ..... 209
    - Tires ..... 204
    - Vehicle ..... 207
  - Distance recorder** ..... 171
    - see Odometer
    - see Trip odometer
  - Doors**
    - Automatic locking (on-board computer) ..... 179
    - Automatic locking (switch) ..... 73
    - Central locking/unlocking (SmartKey) ..... 66
    - Control panel ..... 35
    - Display message ..... 208
    - Emergency locking ..... 74
    - Emergency unlocking ..... 74
    - Important safety notes ..... 72
    - Opening (from inside) ..... 73
  - Drinking and driving** ..... 142
  - Drinks holder**
    - see Cup holder
  - Drive program**
    - Automatic ..... 133
    - Display ..... 130
    - Manual ..... 134
    - SETUP (on-board computer) ..... 181
  - Drive program selector** ..... 132
  - Driver's door**
    - see Doors
  - Driver's seat**
    - see Seats
  - Driving abroad**
    - Mercedes-Benz Service ..... 251
    - Symmetrical low beam ..... 98
  - Driving lamps**
    - see Daytime running lamps
  - Driving on flooded roads** ..... 145
  - Driving safety systems**
    - ABS (Anti-lock Braking System) ..... 59
    - ADAPTIVE BRAKE ..... 63
    - BAS (Brake Assist System) ..... 59
    - Electronic brake force distribution ... 63
    - ESP® (Electronic Stability Program) ..... 60
    - ETS/4ETS (Electronic Traction System) ..... 60
    - Important safety information ..... 58
    - Overview ..... 58

- Driving systems**
- ATTENTION ASSIST ..... 159
  - Blind Spot Assist ..... 160
  - Cruise control ..... 146
  - Display message ..... 201
  - Dynamic handling package with sports mode ..... 148
  - HOLD function ..... 149
  - Lane Keeping Assist ..... 162
  - Lane Tracking package ..... 160
  - Parking Guidance ..... 155
  - PARKTRONIC ..... 152
  - RACE START (AMG vehicles) ..... 150
  - Rear view camera ..... 158
- Driving tips**
- Automatic transmission ..... 131
  - Brakes ..... 143
  - Break-in period ..... 124
  - Downhill gradient ..... 143
  - Drinking and driving ..... 142
  - Driving abroad ..... 98
  - Driving in winter ..... 145
  - Driving on flooded roads ..... 145
  - Driving on wet roads ..... 145
  - Exhaust check ..... 143
  - Fuel ..... 142
  - General ..... 142
  - Hydroplaning ..... 145
  - Icy road surfaces ..... 146
  - Limited braking efficiency on salted roads ..... 144
  - Pedals ..... 142
  - Snow chains ..... 279
  - Symmetrical low beam ..... 98
  - Wet road surface ..... 143
- DVD audio (on-board computer) ..... 174**
- DVD video (on-board computer) ..... 174**
- Dynamic handling package with sports mode ..... 148**
- E**
- EASY-ENTRY feature**
- Activating/deactivating ..... 180
  - Function/notes ..... 92
- EASY-EXIT feature**
- Function/notes ..... 92
  - Switching on/off ..... 180
- EBD (electronic brake force distribution)**
- Display message ..... 188
  - Function/notes ..... 63
- Electrical fuses**
- see Fuses
- Electronic brake force distribution**
- see EBD (electronic brake force distribution)
- Electronic Stability Program**
- see ESP<sup>®</sup> (Electronic Stability Program)
- Electronic Traction System**
- see ETS (Electronic Traction System)
- Emergency release**
- Driver's door ..... 74
  - Trunk ..... 77
  - Vehicle ..... 74
- Emergency spare wheel**
- Storage location ..... 261
- Emergency Tensioning Devices**
- Function ..... 53
  - Safety guidelines ..... 39
- Emissions control**
- Service and warranty information .... 20
- Engine**
- Check Engine warning lamp ..... 217
  - Display message ..... 198
  - Engine number ..... 308
  - Irregular running ..... 129
  - Jump-starting ..... 269
  - Starting problems ..... 129
  - Starting the engine with the key .... 127
  - Starting with KEYLESS-GO ..... 127
  - Switching off ..... 140
  - Tow-starting (vehicle) ..... 273
- Engine electronics**
- Problem (malfunction) ..... 129
- Engine oil**
- Adding ..... 248
  - Additives ..... 311
  - Checking the oil level ..... 247
  - Checking the oil level using the dipstick ..... 247
  - Display message ..... 200
  - Filling capacity ..... 311
  - Notes about oil grades ..... 310
  - Notes on oil level/consumption .... 247

- Temperature (on-board computer) . 181
  - Viscosity ..... 311
  - ESP® (Electronic Stability Program)**
  - AMG menu (on-board computer) ... 181
  - Deactivating/activating (AMG vehicles) ..... 61
  - Deactivating/activating (except AMG vehicles) ..... 176
  - Deactivating/activating (notes; except AMG vehicles) ..... 60
  - Display message ..... 186
  - ETS/4ETS ..... 60
  - Function/notes ..... 60
  - Important safety information ..... 60
  - Warning lamp ..... 214
  - ETS/4ETS (Electronic Traction System)** ..... 60
  - Exhaust check** ..... 143
  - Exhaust tail pipe (cleaning instructions)** ..... 255
  - Exterior lighting**  
see Lights
  - Exterior mirrors**
  - Adjusting ..... 93
  - Dipping (automatic) ..... 94
  - Folding in/out (automatically) ..... 94
  - Folding in/out (electrically) ..... 93
  - Folding in when locking (on-board computer) ..... 181
  - Out of position (troubleshooting) ..... 94
  - Setting ..... 94
  - Storing settings (memory function) ..... 95
  - Storing the parking position ..... 94
- F**
- Filler cap**  
see Fuel filler flap
  - Filling capacities (Technical data)** ... 308
  - First-aid kit** ..... 260
  - Flat tire**
  - Changing a wheel/mounting the spare wheel ..... 261
  - MOExtended run-flat system ..... 265
  - Preparing the vehicle ..... 261
  - Raising the vehicle ..... 263
  - Floormat** ..... 243
  - Front fog lamps** ..... 100
  - Display message ..... 196
  - Switching on/off ..... 100
  - Front windshield**  
see Windshield
  - Fuel**
  - Additives ..... 310
  - Consumption statistics ..... 171
  - Displaying the current consumption ..... 171
  - Displaying the range ..... 171
  - Driving tips ..... 142
  - Fuel gauge ..... 29
  - Grade (gasoline) ..... 309
  - Important safety notes ..... 309
  - Premium-grade unleaded gasoline . 309
  - Problem (malfunction) ..... 140
  - Refueling ..... 137
  - Tank content/reserve fuel ..... 309
  - Fuel filler flap, opening/closing** ..... 138
  - Fuel level**  
Calling up the range (on-board computer) ..... 171
  - Fuel tank**
  - Capacity ..... 309
  - Problem (malfunction) ..... 140
  - Fuse allocation chart (vehicle tool kit)** ..... 260
  - Fuses**
  - Allocation chart ..... 273
  - Before changing ..... 273
  - Fuse box in the engine compartment ..... 273
  - Fuse box in the trunk ..... 274
  - Important safety notes ..... 273
- G**
- Garage door opener**
  - Clearing the memory ..... 241
  - Notes ..... 238
  - Opening/closing the garage door .. 241
  - Programming (button in the rear-view mirror) ..... 239
  - Gear indicator (on-board computer)** ..... 181



<b>Gear or selector lever (cleaning guidelines)</b> .....	256
<b>Genuine Mercedes-Benz parts</b> .....	306
<b>Glove box</b> .....	225

## H

<b>Handbrake</b>	
see Parking brake	
<b>Hazard warning lamps</b> .....	101
<b>Headlamp cleaning system</b>	
Notes .....	312
<b>Headlamps</b>	
Adding fluid to cleaning system .....	249
Cleaning system (function) .....	101
Fogging up .....	103
see Automatic headlamp mode	
<b>Head restraints</b>	
Adjusting .....	89
Adjusting (electrically) .....	89
see NECK-PRO head restraints	
<b>Heating</b>	
see Climate control	
<b>High-beam headlamps</b>	
Changing bulbs .....	106
Display message .....	196
Switching Adaptive Highbeam Assist on/off .....	102
Switching on/off .....	101
<b>Hill start assist</b> .....	128
<b>HOLD function</b>	
Display message .....	201
Function/notes .....	149
<b>Hood</b>	
Closing .....	247
Display message .....	208
Opening .....	246
<b>Hydroplaning</b> .....	145

## I

<b>Ignition lock</b>	
see Key positions	
<b>Immobilizer</b> .....	63
<b>Indicator lamps</b>	
see Warning and indicator lamps	
<b>Indicators</b>	
see Turn signals	

<b>Instrument cluster</b>	
Overview .....	29
Settings .....	177
Warning and indicator lamps .....	30
<b>Instrument cluster lighting</b> .....	29
<b>Instrument lighting</b>	
see Instrument cluster lighting	
<b>Interior lighting</b> .....	104
Automatic control .....	104
Delayed switch-off (on-board computer) .....	179
Emergency lighting .....	104
Manual control .....	104
Overview .....	104
Reading lamp .....	104

## J

<b>Jack</b>	
Storage location .....	260
Using .....	263
<b>Jump starting (engine)</b> .....	269

## K

<b>Key</b>	
see SmartKey	
<b>KEYLESS-GO</b>	
Convenience closing feature .....	80
Display message .....	209
Locking .....	67
Start/Stop button .....	125
Starting the engine .....	127
Unlocking .....	67
<b>Key positions</b>	
KEYLESS-GO .....	125
SmartKey .....	125
<b>Kickdown</b>	
Driving tips .....	132
Manual drive program .....	135
<b>Knee bag</b> .....	42

## L

<b>Lamps</b>	
see Warning and indicator lamps	
<b>Lane-change assistant</b>	
see Blind Spot Assist	

- Lane detection (automatic)**
    - see Lane Keeping Assist
  - Lane Keeping Assist**
    - Activating/deactivating ..... 177
    - Display message ..... 202
    - Function/information ..... 162
  - Lane Tracking package** ..... 160
  - Lap time (RACETIMER)** ..... 182
  - LATCH-type (ISOFIX) child seat anchors** ..... 56
  - Light function, active**
    - Display message ..... 197
  - Lighting**
    - see Lights
  - Lights**
    - Activating/deactivating the interior lighting delayed switch-off . 179
    - Automatic headlamp mode ..... 100
    - Cornering light function ..... 102
    - Display message ..... 195
    - Driving abroad ..... 98
    - Fog lamps ..... 100
    - Hazard warning lamps ..... 101
    - High beam flasher ..... 101
    - High-beam headlamps ..... 101
    - Light switch ..... 98
    - Low-beam headlamps ..... 99
    - Rear fog lamp ..... 100
    - Standing lamps ..... 98
    - Switching Adaptive Highbeam Assist on/off ..... 178
    - Switching the daytime running lamps on/off (on-board computer) ..... 178
    - Switching the daytime running lamps on/off (switch) ..... 99
    - Switching the exterior lighting delayed switch-off on/off (on-board computer) ..... 179
    - Switching the surround lighting on/off (on-board computer) ..... 179
    - Turn signals ..... 101
    - see Changing bulbs
    - see Interior lighting
  - Light sensor (display message)** ..... 197
  - Loading guidelines** ..... 224
  - Locking**
    - see Central locking
  - Locking (doors)**
    - Automatic ..... 73
    - Emergency locking ..... 74
    - From inside (central locking button) ..... 73
  - Locking centrally**
    - see Central locking
  - Locking verification signal (on-board computer)** ..... 180
  - Low-beam headlamps**
    - Changing bulbs ..... 106
    - Display message ..... 195
    - Setting for driving abroad (symmetrical) ..... 98
    - Switching on/off ..... 99
  - Lumbar support**
    - Adjusting the 4-way lumbar support ..... 89
- M**
- M+S tires** ..... 278
  - Maintenance**
    - see ASSYST PLUS service interval display
  - Malfunction message**
    - see Display messages
  - Matte finish (cleaning instructions)** ..... 253
  - mbrace**
    - Call priority ..... 236
    - Display message ..... 190
    - Downloading destinations (COMAND) ..... 237
    - Emergency call ..... 234
    - Important safety notes ..... 232
    - Locating a stolen vehicle ..... 238
    - MB info call button ..... 236
    - Remote vehicle locking ..... 238
    - Roadside Assistance button ..... 235
    - Search & Send ..... 237
    - Self-test ..... 233
    - System ..... 233
    - Vehicle remote unlocking ..... 237
  - Mechanical key**
    - Function/notes ..... 68
    - Locking vehicle ..... 74
    - Unlocking the driver's door ..... 74

<b>Memory card (audio)</b> .....	174
<b>Memory function</b> .....	95
<b>Message memory (on-board computer)</b> .....	185
<b>Messages</b>	
see Display messages	
<b>Mirrors</b>	
see Exterior mirrors	
see Rear-view mirror	
see Vanity mirror	
<b>Mobile phone</b>	
Menu (on-board computer) .....	174
see Phone	
<b>Modifying the programming (SmartKey)</b> .....	68
<b>MOExtended run-flat system</b> .....	265
<b>MP3</b>	
Operation .....	174
see separate operating instructions	
<b>Multifunction display</b>	
Function/notes .....	168
Permanent display .....	178
<b>Multifunction steering wheel</b>	
Operating the on-board computer .	167
Overview .....	31
<b>Multifunction steering wheel (4 buttons)</b>	
see 4-button multifunction steering wheel	

## N

<b>Navigation</b>	
Menu (on-board computer) .....	172
see separate operating instructions	
<b>NECK-PRO head restraints</b>	
Operation .....	49
Resetting after being triggered .....	49
<b>Notes on breaking-in a new vehicle</b> .....	124

## O

<b>Occupant Classification System (OCS)</b>	
Faults .....	48
Operation .....	44
System self-test .....	47
<b>Occupant safety</b>	
Children in the vehicle .....	54
System overview .....	38
<b>OCS</b>	
Faults .....	48
Operation .....	44
System self-test .....	47
<b>Odometer</b> .....	171
see Trip odometer	
<b>Oil</b>	
see Engine oil	
<b>On-board computer</b>	
AMG menu .....	181
Assistance menu .....	176
Audio menu .....	173
Convenience submenu .....	180
Displaying a service message .....	250
Display messages .....	185
Factory settings submenu .....	181
Important safety notes .....	166
Instrument cluster submenu .....	177
Lighting submenu .....	178
Menu overview .....	170
Message memory .....	185
Navigation menu .....	172
Operation .....	167
RACETIMER .....	182
Service menu .....	177
Settings menu .....	177
Standard display .....	171
Telephone menu .....	174
Trip menu .....	171
Vehicle submenu .....	179
Video DVD operation .....	174
<b>Opening and closing the side trim panels</b> .....	107
<b>Operating safety</b>	
Diagnostics connection .....	23
<b>Operating system</b>	
see On-board computer	
<b>Outside temperature display</b> .....	167

- Overhead control panel** ..... 34
- P**
- Paint code number** ..... 307
- Paintwork (cleaning instructions)** ... 253
- Panic alarm** ..... 58
- Panorama roof with power tilt/  
sliding panel**
- Opening/closing ..... 82
  - Opening/closing the roller  
sunblind ..... 82
  - Problem (malfunction) ..... 83
  - Resetting ..... 83
- Panorama sliding sunroof**
- Important safety notes ..... 81
- Parcel net** ..... 225
- Parking** ..... 140
- Important safety notes ..... 140
  - Parking brake ..... 141
  - Position of exterior mirror, front-  
passenger side ..... 94
  - Rear view camera ..... 158
  - see PARKTRONIC
- Parking aid**
- Parking Guidance ..... 155
  - see Exterior mirrors
  - see PARKTRONIC
- Parking brake**
- Display message ..... 188
  - Notes/function ..... 141
- Parking Guidance**
- Display message ..... 203
  - Important safety notes ..... 155
- Parking lamps (changing bulbs)** ..... 106
- PARKTRONIC**
- Deactivating/activating ..... 154
  - Driving system ..... 152
  - Function/notes ..... 152
  - Important safety notes ..... 152
  - Problem (malfunction) ..... 155
  - Range of the sensors ..... 152
  - Warning display ..... 153
- PASSENGER AIR BAG OFF indicator  
lamp** ..... 44
- Pedals** ..... 142
- Plastic trim (cleaning instructions)** . 255
- Power washers** ..... 252
- Power windows**  
see Side windows
- Product information** ..... 20
- Program selector button** ..... 132
- Pulling away**  
Automatic transmission ..... 127
- Q**
- Qualified specialist workshop** ..... 23
- R**
- RACE START (AMG vehicles)** ..... 150
- RACETIMER (on-board computer)** .... 182
- Radar sensor system**
- Activating/deactivating ..... 180
  - Display message ..... 202
- Radio**
- Selecting a station ..... 173
  - see separate operating instructions
- Reading lamp** ..... 104
- Rear compartment**  
Setting the air vents ..... 122
- Rear fog lamp**
- Display message ..... 196
  - Switching on/off ..... 100
- Rear seat (folding the backrest  
forwards/back)** ..... 226
- Rear view camera**
- Cleaning instructions ..... 255
  - Function/notes ..... 158
- Rear-view mirror**
- Anti-glare (manual) ..... 93
  - Dipping (automatic) ..... 94
- Rear window defroster**
- Problem (malfunction) ..... 120
  - Switching on/off ..... 120
- Refueling**
- Fuel gauge ..... 29
  - Important safety notes ..... 137
  - Refueling process ..... 138
  - see Fuel
- Releasing the parking lock  
manually (automatic  
transmission)** ..... 137

- Remote control**
    - Garage door opener ..... 238
    - Programming (garage door opener) ..... 239
  - Reporting safety defects** ..... 24
  - Reserve (fuel tank)**
    - see Fuel
  - Reserve fuel**
    - Display message ..... 201
    - Warning lamp ..... 217
    - see Fuel
  - Restraint system**
    - see SRS (Supplemental Restraint System)
  - Reverse gear**
    - Engaging (automatic transmission) ..... 130
  - Roadside Assistance (breakdown)** .... 21
  - Roller blind**
    - see Roller sunblind
  - Roller sunblind**
    - Opening/closing ..... 82
    - Panorama roof with power tilt/sliding panel ..... 82
  - Roof carrier** ..... 228
  - Roof lining and carpets (cleaning guidelines)** ..... 257
  - Roof load (maximum)** ..... 313
  - Route (navigation)**
    - see Route guidance (navigation)
  - Route guidance (navigation)** ..... 172
- S**
- Safety**
    - Children in the vehicle ..... 54
    - Child restraint systems ..... 54
    - Occupant Classification System (OCS) ..... 44
    - Overview of occupant safety systems ..... 38
  - Safety systems**
    - see Driving safety systems
  - Seat belts**
    - Belt force limiters ..... 53
    - Cleaning ..... 257
    - Correct usage ..... 50
    - Emergency Tensioning Devices ..... 53
    - Fastening ..... 51
    - Important safety guidelines ..... 50
    - Releasing ..... 52
    - Safety guidelines ..... 39
    - Special seat belt retractor ..... 56
    - Warning lamp ..... 210
    - Warning lamp (function) ..... 52
  - Seats**
    - Adjusting (electrically) ..... 88
    - Adjusting (manually and electrically) ..... 88
    - Adjusting the 4-way lumbar support ..... 89
    - Adjusting the head restraint ..... 89
    - Cleaning the cover ..... 256
    - Correct driver's seat position ..... 86
    - Folding the backrests forward/back ..... 89
    - Important safety notes ..... 87
    - Seat backrest display message ..... 208
    - Seat backrest display message (12-button multifunction steering wheel) ..... 208
    - Seat heating problem ..... 90
    - Seat ventilation problem ..... 91
    - Storing settings (memory function) ..... 95
    - Switching seat heating on/off ..... 90
    - Switching seat ventilation on/off .... 90
  - Sensors (cleaning instructions)** ..... 255
  - Service Center**
    - see Qualified specialist workshop
  - Service interval display**
    - Displaying service messages ..... 250
    - Hiding service messages ..... 250
    - Notes ..... 250
    - Service messages ..... 250
  - Service menu (on-board computer)** . 177
  - Service products**
    - Brake fluid ..... 311
    - Coolant (engine) ..... 312
    - Engine oil ..... 310
    - Fuel ..... 309
    - Important safety notes ..... 308
    - Washer fluid ..... 312
  - Settings**
    - Factory (on-board computer) ..... 181
    - On-board computer ..... 177

- Setting the air distribution** ..... 118
- Setting the airflow** ..... 118
- SETUP (on-board computer)** ..... 181
- Side impact air bag** ..... 42
- Side marker lamp (display message)** ..... 197
- Side windows**
  - Convenience closing feature ..... 79
  - Convenience opening feature ..... 79
  - Important safety information ..... 78
  - Opening/closing ..... 78
  - Problem (malfunction) ..... 80
  - Resetting ..... 80
- Sliding sunroof**
  - see Panorama roof with power tilt/sliding panel
- SmartKey**
  - Changing the battery ..... 69
  - Changing the programming ..... 68
  - Checking the battery ..... 69
  - Convenience closing feature ..... 79
  - Convenience opening feature ..... 79
  - Display message ..... 209
  - Door central locking/unlocking ..... 66
  - Important safety notes ..... 66
  - Loss ..... 71
  - Mechanical key ..... 68
  - Positions (ignition lock) ..... 125
  - Problem (malfunction) ..... 71
  - Starting the engine ..... 127
- Snow chains** ..... 279
- Sockets**
  - Points to observe before use ..... 231
  - Rear compartment ..... 231
- Spare wheel**
  - Notes/data ..... 302
  - Storage location ..... 261
  - see Emergency spare wheel
- Specialist workshop** ..... 23
- Speed, controlling**
  - see Cruise control
- Speedometer**
  - Digital ..... 171
  - In the Instrument cluster ..... 29
  - Segments ..... 167
  - Selecting the unit of measurement ..... 177
  - see Instrument cluster
- SPORT handling mode**
  - Activating/deactivating (AMG vehicles) ..... 61
  - Warning lamp ..... 215
- SRS (Supplemental Restraint System)**
  - Display message ..... 190
  - Introduction ..... 38
  - Warning lamp ..... 216
  - Warning lamp (function) ..... 38
- Standing lamps**
  - Changing bulbs ..... 106
  - Display message ..... 196
  - Switching on/off ..... 98
- Starting (engine)** ..... 126
- Station**
  - see Radio
- Steering (display message)** ..... 208
- Steering wheel**
  - Adjusting (electrically) ..... 92
  - Adjusting (manually) ..... 91
  - Button overview ..... 31
  - Buttons (on-board computer) ..... 167
  - Cleaning ..... 256
  - Important safety notes ..... 91
  - Paddle shifters ..... 133
  - Storing settings (memory function) ..... 95
- Steering wheel paddle shifters** ..... 133
- Stopwatch (RACETIMER)** ..... 182
- Stowage areas** ..... 224
- Stowage compartments**
  - Armrest (under) ..... 225
  - Cup holders ..... 228
  - Glove box ..... 225
  - Important safety information ..... 224
  - Parcel net ..... 225
- Stowage well beneath the trunk floor** ..... 227
- Summer opening**
  - see Convenience opening feature
- Summer tires** ..... 278
- Sun visor** ..... 229
- Supplemental Restraint System**
  - see SRS (Supplemental Restraint System)

- Surround lighting (on-board computer)** ..... 179
  - Switching air-recirculation mode on/off** ..... 120
  - Switching off the alarm (ATA)** ..... 64
- T**
- Tachometer** ..... 167
  - Tail lamps**
    - Display message ..... 196
  - Tank**
    - see Fuel tank
  - Tank content**
    - Fuel gauge ..... 29
  - Technical data**
    - Capacities ..... 308
    - Notes ..... 306
    - Tires/wheels ..... 300
    - Vehicle data ..... 313
  - TELEAID**
    - Call priority ..... 236
    - Display message ..... 190
    - Downloading destinations (COMAND) ..... 237
    - Emergency call ..... 234
    - Important safety notes ..... 232
    - Locating a stolen vehicle ..... 238
    - MB info call button ..... 236
    - Remote vehicle locking ..... 238
    - Roadside Assistance button ..... 235
    - Search & Send ..... 237
    - Self-test ..... 233
    - System ..... 233
    - Vehicle remote unlocking ..... 237
  - Telephone**
    - Accepting a call ..... 175
    - Display message ..... 208
    - Menu (on-board computer) ..... 174
    - Number from the phone book ..... 175
    - Redialing ..... 175
    - Rejecting/ending a call ..... 175
  - Temperature**
    - Coolant ..... 166
    - Coolant (on-board computer) ..... 181
    - Engine oil (on-board computer) ..... 181
    - Outside temperature ..... 167
    - Setting (climate control) ..... 118
  - Theft deterrent systems**
    - ATA (Anti-Theft Alarm system) ..... 64
    - Immobilizer ..... 63
  - Through-loading feature** ..... 225
  - Time**
    - see Separate Operator's Manual
  - Timing (RACETIMER)** ..... 182
  - Tiredness assistant**
    - see ATTENTION ASSIST
  - Tire pressure**
    - Calling up (on-board computer) ..... 284
    - Checking manually ..... 283
    - Display message ..... 204
    - Maximum ..... 282
    - Notes ..... 281
    - Pressure loss warning ..... 283
    - Recommended ..... 280
  - Tire pressure monitoring system**
    - Function/notes ..... 284
    - Restarting ..... 287
    - Warning lamp ..... 220
  - Tires**
    - Aspect ratio (definition) ..... 299
    - Average weight of the vehicle occupants (definition) ..... 297
    - Bar (definition) ..... 297
    - Characteristics ..... 297
    - Checking ..... 277
    - Definition of terms ..... 297
    - Direction of rotation ..... 300
    - Display message ..... 204
    - Distribution of the vehicle occupants (definition) ..... 299
    - DOT, Tire Identification Number (TIN) ..... 296
    - DOT (Department of Transportation) (definition) ..... 297
    - GAWR (Gross Axle Weight Rating) (definition) ..... 298
    - GVW (Gross Vehicle Weight) (definition) ..... 298
    - GVWR (Gross Vehicle Weight Rating) (definition) ..... 298
    - Important safety notes ..... 276
    - Increased vehicle weight due to optional equipment (definition) ..... 297
    - Kilopascal (kPa) (definition) ..... 298
    - Labeling (overview) ..... 293



- Load bearing index (definition) ..... 299
- Load index ..... 296
- Load index (definition) ..... 298
- Maximum loaded vehicle weight (definition) ..... 298
- Maximum load on a tire (definition) ..... 298
- Maximum permissible tire pressure (definition) ..... 298
- Maximum tire load ..... 291
- Maximum tire load (definition) ..... 298
- Optional equipment weight (definition) ..... 299
- PSI (pounds per square inch) (definition) ..... 298
- Replacing ..... 300
- Service life ..... 277
- Sidewall (definition) ..... 299
- Speed rating (definition) ..... 298
- Storing ..... 300
- Structure and characteristics (definition) ..... 297
- Temperature ..... 293
- TIN (Tire Identification Number) (definition) ..... 299
- Tire bead (definition) ..... 299
- Tire pressure (definition) ..... 299
- Tire pressures (recommended) ..... 297
- Tire size (data) ..... 300
- Tire size designation, load-bearing capacity, speed rating ..... 294
- Tire tread ..... 277
- Tire tread (definition) ..... 299
- Total load limit (definition) ..... 299
- Traction ..... 292
- Traction (definition) ..... 299
- Tread wear ..... 292
- Uniform Tire Quality Grading Standards ..... 292
- Uniform Tire Quality Grading Standards (definition) ..... 297
- Unladen weight (definition) ..... 298
- Wear indicator (definition) ..... 299
- Wheel rim (definition) ..... 297
- see Flat tire
- Top Tether** ..... 57
- Towing**
  - Important safety guidelines ..... 270
  - Installing the towing eye ..... 271
  - Removing the towing eye ..... 272
  - With the rear axle raised ..... 272
- Towing away**
  - With both axles on the ground ..... 272
- Tow-starting**
  - Emergency engine starting ..... 273
  - Important safety notes ..... 270
- Transmission**
  - see Automatic transmission
- Transporting the vehicle** ..... 272
- Trim pieces (cleaning instructions)** . 256
- Trip computer (on-board computer)** ..... 171
- Trip meter**
  - see Trip odometer
- Trip odometer**
  - Calling up ..... 171
  - Resetting (on-board computer) ..... 172
- Trunk**
  - Emergency release ..... 77
  - Important safety notes ..... 75
  - Locking separately ..... 77
  - Opening (automatically from inside) ..... 76
  - Opening (automatically from outside) ..... 76
- Trunk lid**
  - Display message ..... 207
  - Opening/closing ..... 75
- Turn signals**
  - Display message ..... 195
  - Switching on/off ..... 101
- Type identification plate**
  - see Vehicle identification plate

## U

### Unlocking

- Emergency unlocking ..... 74
- From inside the vehicle (central unlocking button) ..... 73

## V

**Vanity mirror (in the sun visor)** ..... 229

**Vehicle**

Correct use ..... 23  
 Data acquisition ..... 24  
 Display message ..... 207  
 Emergency unlocking ..... 74  
 Equipment ..... 20  
 Individual settings ..... 177  
 Limited Warranty ..... 24  
 Loading ..... 287  
 Locking (in an emergency) ..... 74  
 Locking (SmartKey) ..... 66  
 Lowering ..... 265  
 Maintenance ..... 21  
 Parking for a long period ..... 141  
 Pulling away ..... 127  
 Raising ..... 263  
 Reporting problems ..... 24  
 Towing away ..... 270  
 Transporting ..... 272  
 Unlocking (in an emergency) ..... 74  
 Unlocking (SmartKey) ..... 66  
 Vehicle data ..... 313

**Vehicle battery**

see Battery (vehicle)

**Vehicle data** ..... 313

**Vehicle dimensions** ..... 313

**Vehicle emergency locking** ..... 74

**Vehicle identification number**

see VIN

**Vehicle identification plate** ..... 307

**Vehicle tool kit** ..... 260

**Video (DVD)** ..... 174

**VIN** ..... 307

## W

**Warning and indicator lamps**

ABS ..... 213  
 Brakes ..... 212  
 Check Engine ..... 217  
 Coolant ..... 218  
 ESP® ..... 214  
 ESP® OFF ..... 215  
 Fuel tank ..... 217  
 Overview ..... 30

## PASSENGER AIR BAG OFF

indicator lamp ..... 44

Reserve fuel ..... 217

Seat belt ..... 210

SPORT handling mode ..... 215

SRS ..... 216

Tire pressure monitor ..... 220

**Warranty** ..... 307

**Washer fluid**

Display message ..... 208

**Wheel bolt tightening torque** ..... 265

**Wheel chock** ..... 262

**Wheels**

Changing a wheel ..... 261

Checking ..... 277

Cleaning ..... 252

Important safety notes ..... 276

Interchanging/changing ..... 300

Mounting a new wheel ..... 264

Removing a wheel ..... 264

Storing ..... 300

Tightening torque ..... 265

Wheel size/tire size ..... 300

**Window curtain air bag**

Display message ..... 190

Operation ..... 44

**Windows**

Cleaning ..... 253

see Side windows

**Windshield**

Defrosting ..... 119

**Windshield washer fluid**

see Windshield washer system

**Windshield washer system** ..... 249

Notes ..... 312

**Windshield wipers**

Problem (malfunction) ..... 110

Replacing the wiper blades ..... 109

Switching on/off ..... 108

**Winter driving**

Important safety notes ..... 278

Slippery road surfaces ..... 146

Snow chains ..... 279

**Winter tires**

M+S tires ..... 278

**Wiper blades**

Cleaning ..... 254

Important safety notes ..... 109

Replacing .....	109
Replacing (windshield) .....	110
<b>Wooden trim (cleaning instructions) .....</b>	<b>256</b>
<b>Workshop</b>	
see Qualified specialist workshop	

### Product information

Mercedes-Benz recommends that you use genuine Mercedes-Benz parts, conversion parts and accessories that have been approved for the type of vehicle.

Mercedes-Benz tests genuine parts as well as conversion parts and accessories which have been specifically approved for your vehicle for their reliability, safety and suitability. Despite ongoing market research, Mercedes-Benz is unable to assess other parts. Therefore, Mercedes-Benz accepts no responsibility for the use of such parts in Mercedes-Benz vehicles, even if they have been independently or officially approved. The use of non-approved parts could affect your vehicle's operating safety. Mercedes-Benz therefore recommends that you use genuine Mercedes-Benz parts, conversion parts and accessories that have been approved for the type of vehicle. Genuine Mercedes-Benz parts, approved conversion parts and accessories are available from any authorized Mercedes-Benz Center. Here, you will receive advice about permissible technical modifications, and the parts will be professionally installed.

### Operator's Manual

#### Notes on the Operator's Manual

This Operator's Manual contains a great deal of helpful information. We urge you to read it carefully and familiarize yourself with the vehicle before driving.

For your own safety and longer service life of the vehicle, we urge you to follow the instructions and warnings contained in this Operator's Manual. Ignoring them could result in damage to the vehicle or personal injury to you or others. Vehicle damage caused by failure to follow instructions is not covered by the Mercedes-Benz Limited Warranty.

### Vehicle equipment

This Operator's Manual describes all models and all standard and optional equipment of your vehicle available at the time of going to print. Country-specific differences are possible. Please note that your vehicle may not be equipped with all features described. This also applies to safety-related systems and functions. The equipment in your vehicle may therefore differ from some of the descriptions or illustrations.

The original purchase agreement lists all systems installed in your vehicle.

Contact an authorized Mercedes-Benz Center if you have any questions about equipment or operation.

The Operator's Manual and the Maintenance Booklet are important documents and should be kept in the vehicle.

### Service and vehicle operation

#### Service and literature

Your vehicle is covered under the terms of the warranties printed in the Service and Warranty Information booklet. Your authorized Mercedes-Benz Center will exchange or repair any defective parts originally installed in the vehicle in accordance with the terms of the following warranties:

- New Vehicle Limited Warranty
- Emission Systems Warranty
- Emission Performance Warranty
- California, Connecticut, Maine, Massachusetts, New York, Pennsylvania, Rhode Island and Vermont Emission Control Systems Warranty
- State warranty enforcement laws (lemon laws)

### Information for customers in California

Under California law you may be entitled to a replacement of your vehicle or a refund of the purchase price or lease price, if after a reasonable number of repair attempts Mercedes-Benz USA, LLC and/or its authorized repair or service facilities fail to fix one or more substantial defects or malfunctions in the vehicle that are covered by its express warranty. During the period of 18 months from original delivery of the vehicle or the accumulation of 18 000 miles (approximately 29 000 km) on the odometer of the vehicle, whichever occurs first, a reasonable number of repair attempts is presumed for a retail buyer or lessee if one or more of the following occurs:

- (1) the same substantial defect or malfunction results in a condition that is likely to cause death or serious bodily injury if the vehicle is driven, that defect or malfunction has been subject to repair two or more times, and you have directly notified Mercedes-Benz USA, LLC in writing of the need for its repair.
- (2) the same substantial defect or malfunction of a less serious nature than category (1) has been subject to repair four or more times and you have directly notified Mercedes-Benz in writing of the need for its repair.
- (3) the vehicle is out of service by reason of repair of the same or different substantial defects or malfunctions for a cumulative total of more than 30 calendar days.

Please send your written notice to:  
Mercedes-Benz USA, LLC  
Customer Assistance Center  
One Mercedes Drive  
Montvale, NJ 07645-0350

### Maintenance

The Service and Warranty Booklet describes all the necessary maintenance work which should be done at regular intervals.

Always have the Service and Warranty Booklet with you when you bring the vehicle to an authorized Mercedes-Benz Center. The service advisor will record every service for you in the Service and Warranty Booklet.

### Breakdown assistance

The Mercedes-Benz Roadside Assistance Program offers technical help in the event of a breakdown. Calls to the toll-free Roadside Assistance Hotline are answered by our agents 24 hours a day, 365 days a year.

**1-800-FOR-MERCEdes(1-800-367-6372)  
(USA)**

**1-800-387-0100 (Canada)**

For additional information, refer to the Mercedes-Benz Roadside Assistance Program brochure (USA) or the "Roadside Assistance" section in the Service and Warranty booklet (Canada). You will find both in your vehicle literature portfolio.

### Change of address or change of ownership

In the event of a change of address, please send us the "Change of Address Notice" found in the Service and Warranty Information Booklet, or simply call the Mercedes-Benz Customer Assistance Center (in the USA) at the hotline number 1-800-FOR-MERCEdes(1-800-367-6372) or Customer Service Center (in Canada) at 1-800-387-0100. This will assist us in contacting you in a timely manner should the need arise.

If you sell your Mercedes, please leave the entire literature in the vehicle so that it is available to the next owner.

If you bought this vehicle used, be sure to send in the "Notice of Purchase of Used Car" found in the Service and Warranty Information Booklet, or call the Mercedes-Benz Customer Assistance Center (in the USA) at 1-800-FOR-MERCEdes(1-800-367-6372) or Customer Service (in Canada) at 1-800-387-0100.

### Vehicle operation outside the USA and Canada

If you plan to operate your vehicle in foreign countries, please be aware that:

- service facilities or replacement parts may not be readily available.
- unleaded fuel for vehicles with a catalytic converter may not be available. Leaded fuel may cause damage to the catalytic converter.
- the fuel may have a considerably lower octane rating. Unsuitable fuel can cause engine damage.

Some Mercedes-Benz models are available for delivery in Europe through our European Delivery Program. For details, consult an authorized Mercedes-Benz Center or write to one of the following addresses.

#### In the USA

Mercedes-Benz USA, LLC  
European Delivery Department  
One Mercedes Drive  
Montvale, NJ 07645-0350

#### In Canada

Mercedes-Benz Canada, Inc.  
European Delivery Department  
98 Vanderhoof Avenue  
Toronto, Ontario M4G 4C9

## Operating safety

### Safety notes

#### WARNING

Work improperly carried out on electronic components and associated software could cause them to cease functioning. Because the vehicle's electronic components are interconnected, any modifications made may produce an undesired effect on other systems. Electronic malfunctions could seriously impair the operating safety of your vehicle.

Contact an authorized Mercedes-Benz Center for repairs or modifications to electronic components.

Other improper work or modifications on the vehicle could also have a negative impact on the operating safety of the vehicle.

Some safety systems only function when the engine is running. You should therefore never turn off the engine while driving.

#### WARNING

Heavy blows against the vehicle underbody or tires/wheels may cause serious damage and impair the operating safety of your vehicle. Such blows can be caused, for example, by running over an obstacle, road debris or a pothole.

If you feel a sudden significant vibration or ride disturbance, or you suspect that damage to your vehicle has occurred:

- turn on your hazard warning flashers.
- slow down carefully.
- drive with caution to an area which is a safe distance from the road.

Inspect the vehicle underbody and tires/wheels for possible damage. If the vehicle appears unsafe, have it towed to the nearest authorized Mercedes-Benz Center or other qualified maintenance or repair facility for further inspection or repairs.

## Declarations of conformity

### Vehicle components which receive and/or transmit radio waves

**USA:** "The wireless devices of this vehicle comply with Part 15 of the FCC Rules. Operation is subject to the following two conditions: 1) These devices may not cause harmful interference, and 2) These devices must accept any interference received, including interference that may cause undesired operation. Changes or modifications not expressly approved by the party responsible for compliance could void the user's authority to operate the equipment."

**Canada:** "The wireless devices of this vehicle comply with Industry Canada license-exempt RSS standard(s). Operation is subject to the following two conditions: (1) These devices may not cause interference, and (2) These devices must accept any interference, including interference that may cause undesired operation of the device."

## Diagnostics connection

### WARNING

If you connect equipment to the diagnostics connection, it can affect the operation of the vehicle systems. This can impair the operating safety of your vehicle while driving. There is a risk of accident.

Do not connect any equipment to the diagnostics connection.

### WARNING

Loose equipment or equipment cables that are connected to the diagnostics connection can obstruct the area around the pedals. The equipment or the cables could get between the pedals in the event of sudden braking or acceleration. As a result, the movement of the pedals may be impaired. There is a risk of accident.

Do not attach any equipment or cables in the driver footwell.

-  If the engine is switched off and equipment on the diagnostics connection is used, the starter battery may discharge.

The diagnostics connection is only intended for the connection of diagnostic equipment at a qualified specialist workshop.

Connecting equipment to the diagnostics connection can, for example, lead to emissions monitoring information being reset. This may lead to the vehicle failing to meet the requirements of the next emissions test during the main inspection.

## Qualified specialist workshop

An authorized Mercedes-Benz Center is a qualified specialist workshop. It has the necessary specialist knowledge, tools and qualifications to correctly carry out the work required on your vehicle. This is especially the case for work relevant to safety.

Observe the notes in the Maintenance Booklet.

Always have the following work carried out at an authorized Mercedes-Benz Center:

- work relevant to safety
- service and maintenance work
- repair work
- alterations, installation work and modifications
- work on electronic components

## Correct use

### WARNING

There are various warning stickers affixed to your vehicle. Their purpose is to alert you and others to various dangers. Therefore, do not remove any warning stickers unless the sticker clearly states that you may do so.



If you remove any warning stickers, you or others could fail to recognize certain dangers and be injured.

When driving your vehicle observe the following information:

- the safety notes in this manual
- the "Technical data" section in this manual
- traffic rules and regulations
- laws and safety standards pertaining to motor vehicles

### Problems with your vehicle

If you should experience a problem with your vehicle, particularly one that you believe may affect its safe operation, we urge you to contact an authorized Mercedes-Benz Center immediately to have the problem diagnosed and rectified. If the problem is not resolved to your satisfaction, please discuss the problem again with a Mercedes-Benz Center or contact us at one of the following addresses.

#### In the USA

Customer Assistance Center  
Mercedes-Benz USA, LLC  
One Mercedes Drive  
Montvale, NJ 07645-0350

#### In Canada

Customer Relations Department  
Mercedes-Benz Canada, Inc.  
98 Vanderhoof Avenue  
Toronto, Ontario M4G 4C9

### Reporting malfunctions relevant to safety

USA only:

The following text is reproduced as required of all manufacturers according to Title 49, Code of U.S. Federal Regulations, Part 575

pursuant to the National Traffic and Motor Vehicle Safety Act of 1966.

### Reporting safety defects

If you believe that your vehicle has a defect which could cause a crash or could cause injury or death, you should immediately inform the National Highway Traffic Safety Administration (NHTSA) in addition to notifying Mercedes-Benz USA, LLC.

If NHTSA receives similar complaints, it may open an investigation, and if it finds that a safety defect exists in a group of vehicles, it may order a recall and remedy campaign. However, NHTSA cannot become involved in individual problems between you, your dealer, or Mercedes-Benz USA, LLC.

To contact NHTSA, you may call the Vehicle Safety Hotline toll-free at 1-888-327-4236 (TTY: 1-800-424-9153); go to <http://www.safercar.gov>; or write to: Administrator, NHTSA Headquarters, 1200 New Jersey Avenue, SE, West Building, Washington, DC 20590.

You can obtain additional information about vehicle safety from:

<http://www.safercar.gov>.

### Limited Warranty

- Follow the instructions in this manual about the proper operation of your vehicle as well as about possible vehicle damage. Damage to your vehicle that arises from culpable contraventions against these instructions is not covered either by the Mercedes-Benz Limited Warranty or by the New or Used-Vehicle Warranty.

### Data stored in the vehicle

### Information about electronic data acquisition in the vehicle

(Including notice pursuant to California Code § 9951)

Your vehicle records electronic data. If your vehicle is equipped with mbrace<sup>1</sup>, data is transmitted in the event of an accident.

This information helps, for example, to test vehicle systems after an accident and to continually improve vehicle safety.

Daimler AG can access this data and submit it:

- for safety research or vehicle diagnosis purposes
- with the consent of the vehicle owner
- on the instruction of prosecuting authorities
- for use in arbitration of disputes that involve Daimler AG, its affiliates or its sales and service organizations
- as otherwise required or permitted by law.

Please observe the mbrace<sup>1</sup> purchase agreement for further details on the recording and transfer of data by this system.

<sup>1</sup> The system is called TELE AID in Canada.



Cockpit .....	28
Instrument cluster .....	29
Multifunction steering wheel .....	31
Center console .....	32
Overhead control panel .....	34
Door control panel .....	35

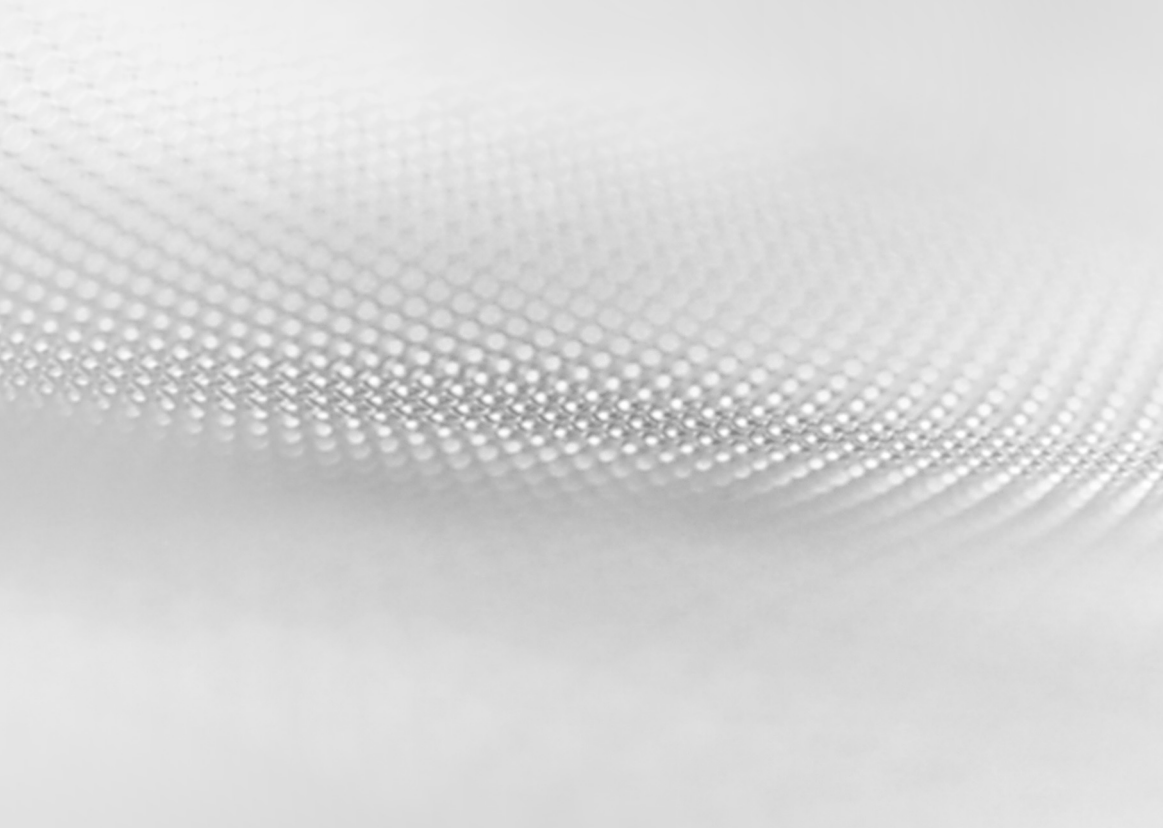

## Cockpit

At a glance

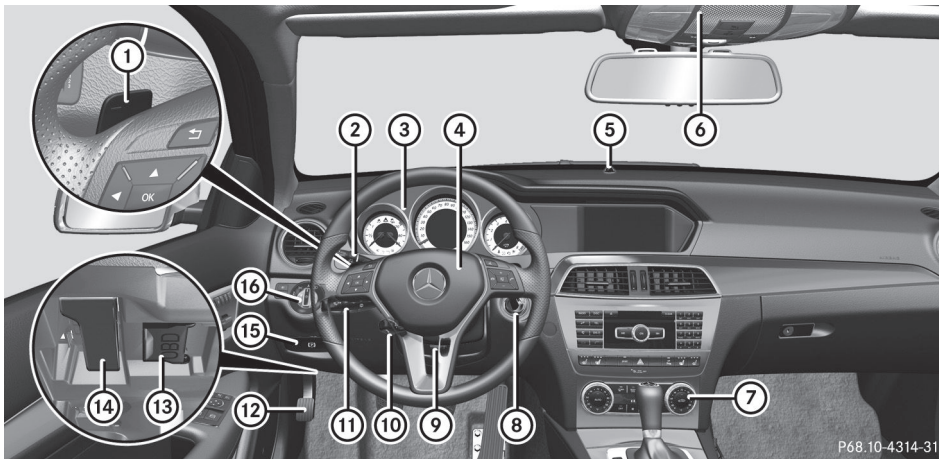

	Function	Page
①	Steering wheel paddle shifters	133
②	Cruise control lever	147
③	Instrument cluster	29
④	Horn	
⑤	PARKTRONIC warning display (Canada only)	152
⑥	Overhead control panel	34
⑦	Climate control systems	114
⑧	Ignition lock	125
	Start/Stop button	125

	Function	Page
⑨	Adjusts the steering wheel manually	91
⑩	Adjusts the steering wheel electrically	91
⑪	Combination switch	101
⑫	Parking brake	141
⑬	Diagnostics connection	23
⑭	Opens the hood	246
⑮	Releases the parking brake	141
⑯	Light switch	98

Instrument cluster

Displays and controls

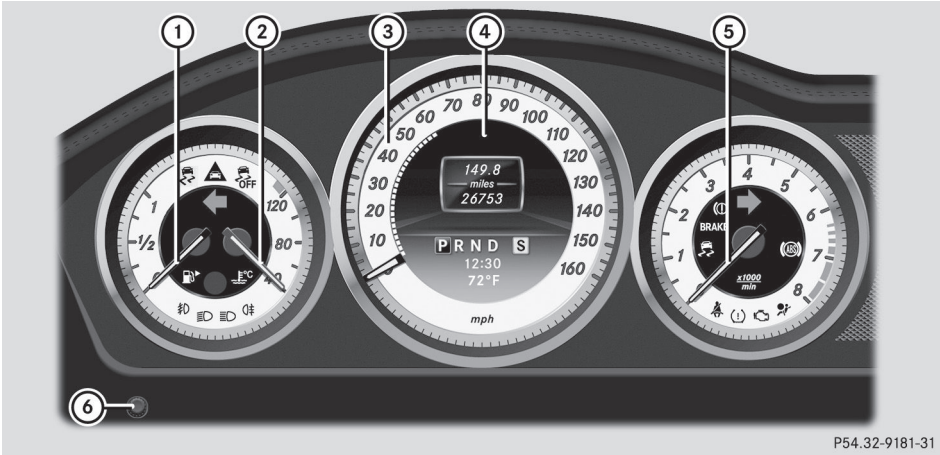

P54.32-9181-31

At a glance

	Function	Page
①	Fuel gauge	
②	Coolant temperature	166
③	Speedometer with segments	167
④	Multifunction display	168

	Function	Page
⑤	Tachometer	167
⑥	Instrument cluster lighting brightness control: turn clockwise or counter-clockwise	

## Warning and indicator lamps

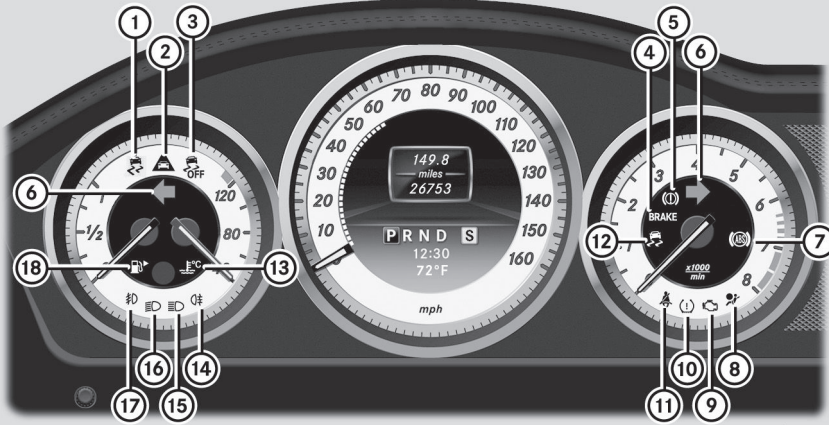

P54.32-9182-31

	Function	Page
①	ESP® SPORT handling mode in AMG vehicles	214 215
②	This lamp has no function	
③	ESP® OFF	214
④	Brakes (USA only)	212
⑤	Brakes (Canada only)	212
⑥	Turn signals	101
⑦	ABS	213
⑧	SRS	216
⑨	Engine Check	217







	Function	Page
⑩	Tire pressure monitor	220
⑪	Seat belt	210
⑫	ESP® in AMG vehicles	214
⑬	Coolant	218
⑭	Rear fog lamp	100
⑮	High-beam headlamps	101
⑯	Low-beam headlamps	99
⑰	Front fog lamps	100
⑱	Reserve fuel	217









Multifunction steering wheel



At a glance

	Function	Page
①	Multifunction display	168
②	Audio/COMAND display; see the separate operating instructions	
③	 Switches on the Voice Control System; see the separate operating instructions	
④	 Rejects or ends a call Exits phone book/redial memory  Makes or accepts a call Switches to the redial memory   Adjusts the volume  Mute	174

	Function	Page
⑤	  Selects a menu   Selects a submenu or scrolls through lists  Confirms a selection Hides display messages	167
⑥	 Back Switches off the Voice Control System; see the separate operating instructions	167





## Center console

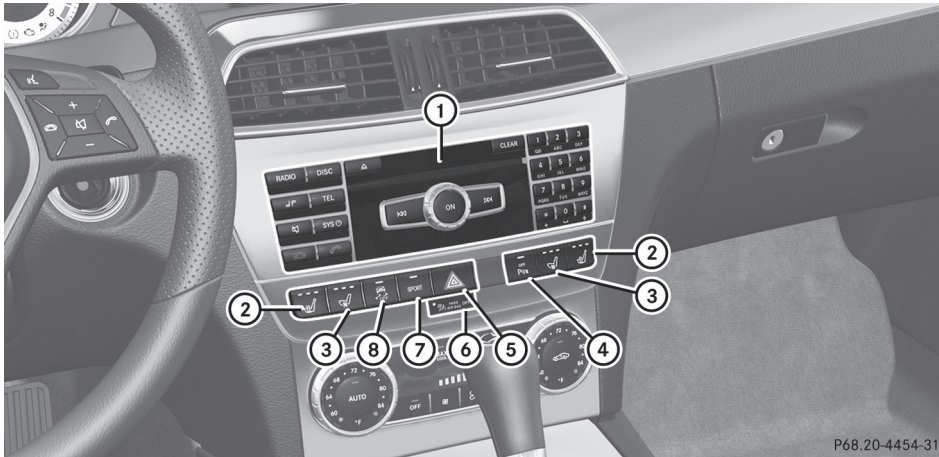



## Center console, upper section

At a glance



P68.20-4454-31

	Function	Page
①	Audio system/COMAND; see the separate operating instructions	
②	 Seat heating	90
③	 Seat ventilation	90
④	 PARKTRONIC (Canada only)	152
⑤	 Hazard warning lamps	101

	Function	Page
⑥	 Indicator lamp	44
⑦	 Dynamic driving package with sports mode	148
	 AMG vehicles: ESP®	61
⑧	 AMG vehicles: ESP®	61

## Center console, lower section

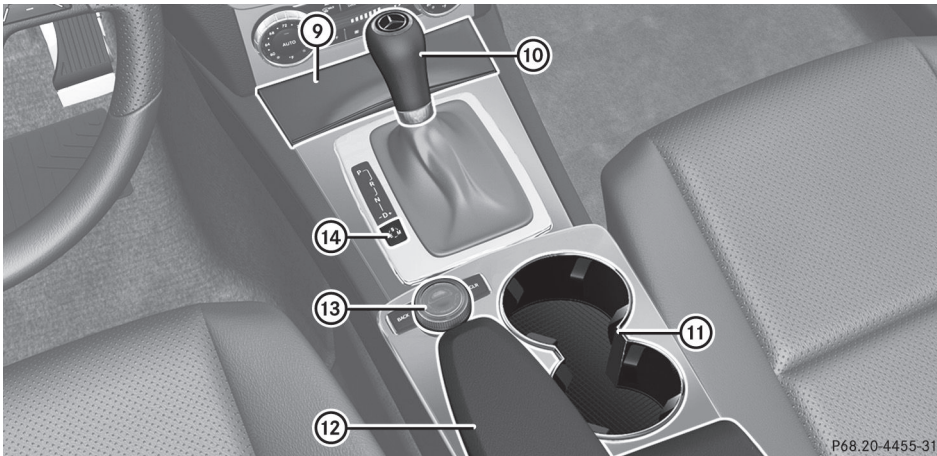

At a glance





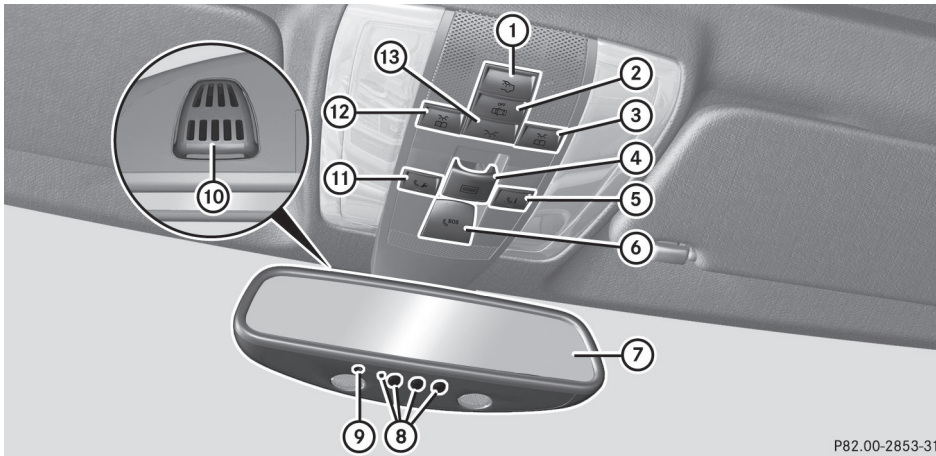

	Function	Page		Function	Page
⑨	Stowage compartment	224	⑬	Audio/COMAND controller; see the separate operating instructions	
	Ashtray	230			
	Cigarette lighter	230			
⑩	Selector lever	130	⑭	 Selects the drive program	132
⑪	Cup holder	228			
⑫	Stowage compartment	224			



## Overhead control panel

At a glance



P82.00-2853-31

	Function	Page
①	 Switches the rear interior lighting on/off	104
②	 Switches the automatic interior lighting control on/off	104
③	 Switches the right-hand reading lamp on/off	104
④	 Opens/closes the panorama roof with power tilt/sliding panel and roller sunblinds	82
⑤	 Button for MB Info call (mbrace system)	236
⑥	 SOS button (mbrace system)	234
⑦	Rear-view mirror	93





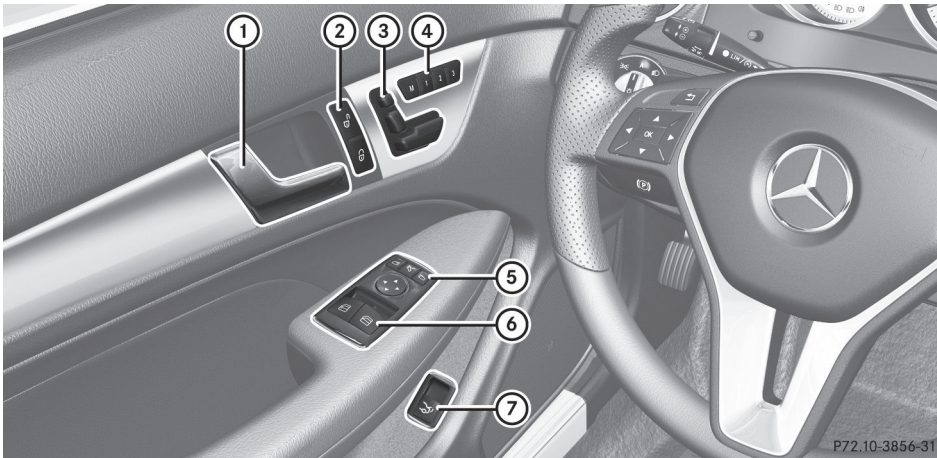

	Function	Page
⑧	Buttons for the garage door opener	241
⑨	Integrated electronic compass	242
⑩	Microphone for mbrace (emergency call system), telephone and the Voice Control System <sup>2</sup>	
⑪	 Roadside Assistance button (mbrace system)	235
⑫	 Switches the left-hand reading lamp on/off	104
⑬	 Switches the front interior lighting on/off	104



<sup>2</sup> The Voice Control System is only available together with COMAND. Observe the additional operating instructions.

Door control panel



At a glance

	Function	Page
①	Opens the door	73
②	  Unlocks/locks the vehicle	73
③	Adjusts the seat electrically	88
④	    Stores settings for the seat, exterior mirrors and steering wheel	95

	Function	Page
⑤	 Adjusts and folds the exterior mirrors in/out electrically	93
⑥	 Opens/closes the side windows	78
⑦	 Opens the trunk lid	76



Useful information ..... 38  
Occupant safety ..... 38  
Children in the vehicle ..... 54  
Panic alarm ..... 58  
Driving safety systems ..... 58  
Theft deterrent locking system ..... 63

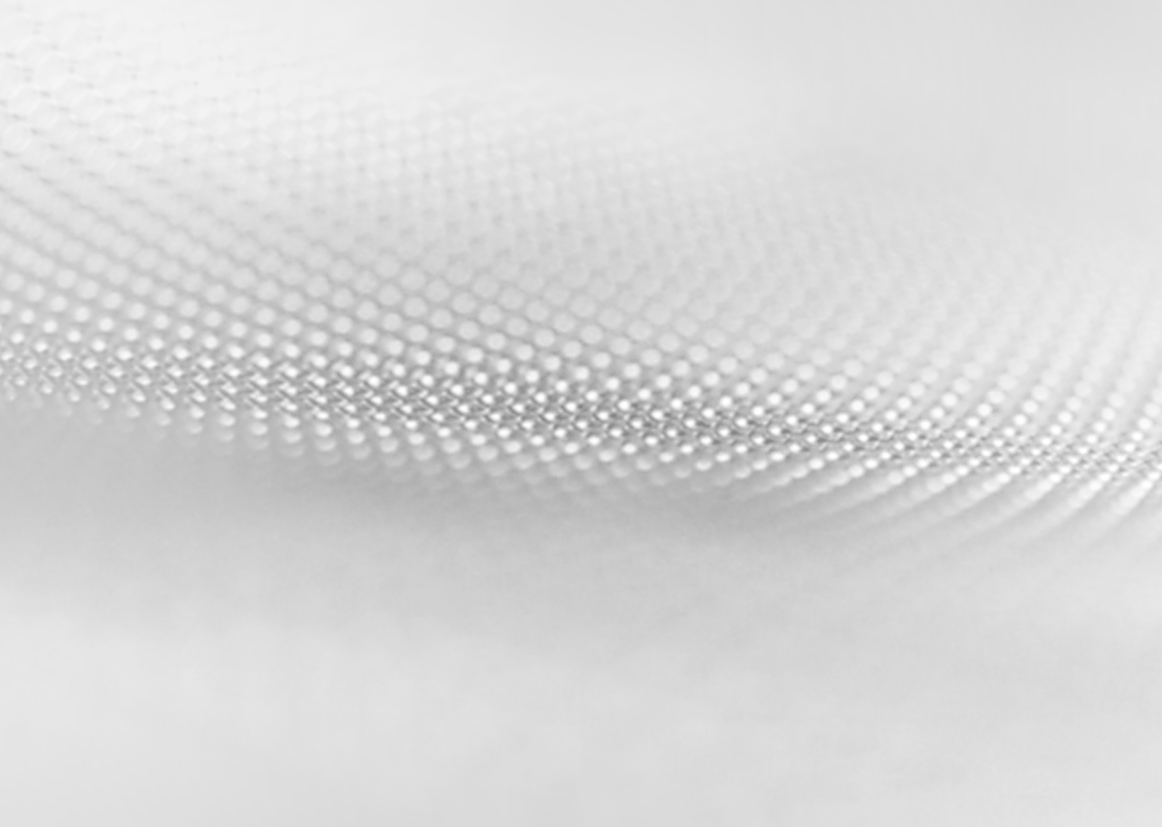



### Useful information

- i** This Operator's Manual describes all models and all standard and optional equipment of your vehicle available at the time of publication of the Operator's Manual. Country-specific differences are possible. Please note that your vehicle may not be equipped with all features described. This also applies to safety-related systems and functions.
- i** Please read the information on qualified specialist workshops (▷ page 23).

### Occupant safety

#### Overview of occupant safety

In this section, you will learn the most important facts about the restraint system components of the vehicle.

The restraint system consists of:

- seat belts
- child restraint systems
- LATCH-type (ISOFIX) child seat anchors

Additional protection is provided by:

- SRS (Supplemental Restraint System)
- NECK-PRO head restraints
- Air bag system components with:
  - PASSENGER AIR BAG OFF indicator lamp
  - front-passenger seat with Occupant Classification System (OCS)

The different air bag systems work independently of each other. The protective functions of the system work in conjunction with each other. Not all air bags are deployed in an accident.

#### WARNING

Modifications to or work improperly conducted on restraint system components or their wiring, as well as tampering with interconnected electronic systems, can lead

to the restraint systems no longer functioning as intended.

Air bags or Emergency Tensioning Devices (ETDs), for example, could deploy inadvertently or fail to deploy in accidents although the deceleration threshold for air bag deployment is exceeded. Therefore, never modify the restraint systems. Do not tamper with electronic components or their software.

- i** See "Children in the vehicle" (▷ page 54) for more information on infants and children traveling with you in the vehicle and restraints for infants and children.

### SRS (Supplemental Restraint System)

#### Introduction

SRS consists of:

- the  SRS warning lamp
- air bags
- air bag control unit (with crash sensors)
- Emergency Tensioning Devices
- belt force limiters

SRS reduces the risk of occupants coming into contact with the vehicle's interior in the event of an accident. It can also reduce the effect of the forces to which occupants are subjected during an accident.

#### SRS warning lamp

SRS functions are checked regularly when you switch on the ignition and when the engine is running. Therefore, malfunctions can be detected in good time.

The  SRS warning lamp in the instrument cluster lights up when the ignition is switched on. It goes out no later than a few seconds after the engine is started.

The SRS components are in operational readiness if the  SRS warning lamp is not lit while the engine is running.



**⚠ WARNING**

The SRS self-check has detected a malfunction if the  SRS indicator lamp:

- does not light up at all
- does not go out after approximately four seconds after the engine is started
- comes on after the engine was started or while driving.

For your safety, Mercedes-Benz strongly recommends that you have the system checked as soon as possible at an authorized Mercedes-Benz Center. SRS may otherwise fail to activate when it is needed in the event of an accident, which could lead to serious or fatal injuries. SRS might also be activated unexpectedly and unnecessarily, which could also result in injury.

In addition, work carried out improperly on SRS may render SRS inoperative or cause unintended air bag deployment. Work on the SRS system should only be carried out by qualified specialist personnel. Consult an authorized Mercedes-Benz Center.

If it is necessary to modify an air bag system to accommodate a person with disabilities, contact an authorized Mercedes-Benz Center for details. USA only: for further information contact our Customer Assistance center at 1-800-FOR-MERCEDES (1-800-367-6372).

### Safety guidelines for seat belts, Emergency Tensioning Devices (ETDs) and air bags

**⚠ WARNING**

- Damaged seat belts or seat belts that have been subjected to stress in an accident must be replaced. Their anchoring points must also be checked. Only use seat belts installed or supplied by an authorized Mercedes-Benz Center.
- Air bags and pyrotechnic Emergency Tensioning Devices (ETDs) contain perchlorate material, which may require special handling and regard for the

environment. Check your national disposal guidelines. California residents, see [www.dtsc.ca.gov/HazardousWaste/Perchlorate/index.cfm](http://www.dtsc.ca.gov/HazardousWaste/Perchlorate/index.cfm).

- Air bags and ETDs are designed to function on a one-time-only basis. An air bag or ETD that has deployed must be replaced.
- Do not pass seat belts over sharp edges. They could tear.
- Do not make any modification that could change the effectiveness of the seat belts.
- Do not bleach or dye seat belts as this may severely weaken them. In a crash they may not be able to provide adequate protection.
- No modifications of any kind may be made to any components or wiring of the SRS.
- Do not change or remove any component or part of the SRS.
- Do not install additional trim material, seat covers, badges, etc. over the steering wheel hub, front-passenger front air bag cover, outer sides of the seat backrests, door trim panels, or door frame trims.
- Do not install additional electrical/ electronic equipment on or near SRS components and wiring.
- Keep area between air bags and occupants free of objects (e.g. packages, purses, umbrellas, etc.).
- Do not hang items such as coat hangers from the coat hooks or handles over the door. These items may be thrown around in the vehicle and cause head and other injuries when the window curtain air bag is deployed.
- Air bag system components will be hot after an air bag has inflated. Do not touch them.
- Never place your feet on the instrument panel, dashboard, or on the seat. Always keep both feet on the floor in front of the seat.
- Improper repair work on the SRS creates a risk of rendering the SRS inoperative or causing unintended air bag deployment. Work on the SRS must therefore only be

performed by qualified technicians. Contact an authorized Mercedes-Benz Center.

- For your protection and the protection of others, when scrapping the air bag unit or ETD, our safety instructions must be followed. These instructions are available from any authorized Mercedes-Benz Center.
- Given the considerable deployment speed, required inflation volume, and the material of the air bags, there is the possibility of abrasions or other, potentially more serious injuries resulting from air bag deployment.

If you sell your vehicle, Mercedes-Benz strongly recommends that you inform the subsequent owner that the vehicle is equipped with SRS. Also, refer them to the applicable section in the Operator's Manual.

### Air bags

#### Important safety notes

##### WARNING

Air bags are designed to reduce the incidence of injuries and fatalities in certain situations:

- frontal impacts (driver's and front-passenger front air bags and driver's knee bag)
- side impacts (side impact air bags, window curtain air bags and pelvis air bags)

However, no system available today can completely eliminate injuries and fatalities.

When the air bags are deployed, a small amount of powder is released. The powder generally does not constitute a health hazard and does not indicate that there is a fire in the vehicle. In order to prevent potential breathing difficulties, you should leave the vehicle as soon as it is safe to do so. If you have any breathing difficulty but cannot get out of the vehicle after the air bag inflates, then get fresh air by opening a window or door.

##### WARNING

In order to reduce the potential danger of injuries caused during the deployment of the front air bags, the driver and front passenger must always be correctly seated and wear their seat belts.

For maximum protection in the event of a collision, you must always be in the normal seat position with your back against the backrest. Fasten your seat belt and make sure that it is correctly positioned on your body.

As the air bag inflates with considerable speed and force, a proper seating position and correct positioning of the hands on the steering wheel will help to keep you at a safe distance from the air bag. Occupants who are not wearing their seat belt, are not seated properly or are too close to the air bag can be seriously injured or killed by an air bag, as it inflates with great force instantaneously:

- sit with the seat belt fastened correctly and in a position that is as upright as possible with your back against the backrest.
- move the driver's seat as far back as possible, still permitting proper operation of vehicle controls. The distance from the center of the driver's chest to the center of the air bag cover on the steering wheel must be at least 10 inches (25 cm). You should be able to accomplish this by adjusting the seat and steering wheel. If you have any difficulties, please contact an authorized Mercedes-Benz Center.
- do not lean your head or chest close to the steering wheel or dashboard.
- only hold the steering wheel on the outside. Placing hands and arms inside the rim can increase the risk and potential severity of hand/arm injury if the driver front air bag inflates.
- adjust the front-passenger seat as far back as possible from the dashboard when the seat is occupied.
- occupants, especially children, should never place their bodies or lean their heads in the area of the door or the rear side trim

panel where the side impact air bag inflates. This could result in serious or fatal injuries should the side impact air bag be deployed. Always sit as upright as possible, wear the seat belt properly and use an appropriately sized infant restraint, toddler restraint or booster seat recommended for the size and weight of the child.

Failure to follow these instructions can result in severe injuries to you or other occupants.

If you sell your vehicle, it is important that you make the buyer aware of this safety information. Be sure to give the buyer this Operator's Manual.

#### **WARNING**

Accident research shows that the safest place for children in an automobile is in a rear seat.

A side impact air bag related injury may occur if occupants, especially children, are not properly seated or restrained when next to a side impact air bag which needs to deploy rapidly in a side impact in order to do its job.

To help avoid the possibility of injury, please follow these guidelines:

- (1) Always sit as upright as possible and use the seat belts properly. Make sure that children 12 years old and under use an appropriately sized child restraint, infant restraint, or booster seat recommended for the size and weight of the child.
- (2) Always wear seat belts properly.

The air bags are only deployed if the air bag control unit detects the need for deployment. Only in the event of such a situation will they provide their supplemental protection.

The driver and passenger should always wear their seat belts. Otherwise, it is not possible for the air bags to provide their supplemental protection.

In the event of other types of impacts and impacts below air bag deployment thresholds, the air bags will not deploy. The

driver and passengers will then be protected to the extent possible by a properly fastened seat belt. A properly fastened seat belt is also needed to provide the best possible protection in a rollover.

Air bags provide additional protection; they are not, however, a substitute for seat belts. All vehicle occupants must fasten their seat belts regardless of whether your vehicle is equipped with air bags or not.

It is important for your safety and that of your passenger to have deployed air bags replaced and to have any malfunctioning air bags repaired. This will help to make sure the air bags continue to perform their protective function for the vehicle occupants in the event of a crash.

### Front air bags

The front air bags increase protection for the driver's and front-passenger's head and chest.

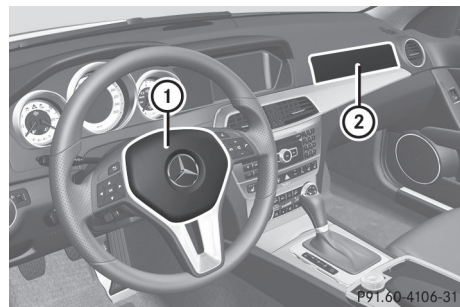

Driver's air bag ① deploys in front of the steering wheel; front-passenger front air bag ② deploys in front of and above the glove box.

They are deployed:

- in the event of certain frontal impacts
- if the system determines that air bag deployment can offer additional protection to that provided by the seat belt
- if the seat belt is fastened
- independently of other air bags in the vehicle

Your vehicle has adaptive, two-stage front air bags. In the event of a collision, the air bag control unit evaluates the vehicle deceleration. In the first deployment stage, the front air bag is filled with enough propellant gas to reduce the risk of injuries. The front air bag is fully deployed if a second deployment threshold is exceeded within a few milliseconds.

The deployment of the front-passenger front air bag is also influenced by the weight category of the front passenger, which is determined by the Occupant Classification System (OCS) (▷ page 44).

The lighter the passenger-side occupant, the higher the vehicle deceleration rate required (predicted at the start of the impact) for second stage inflation of the front-passenger front air bag. In the second stage, the front air bags are inflated with the maximum amount of propellant gas available.

The front air bags are not deployed in situations where a low impact severity is predicted. You will then be protected by the fastened seat belt.

The front-passenger front air bag will only deploy if:

- the system, based on the OCS weight sensor readings, detects that the front-passenger seat is occupied.
- the  indicator lamp in the center console is not lit, (▷ page 44).
- the air bag control unit predicts a high impact severity.

### Driver's knee bag

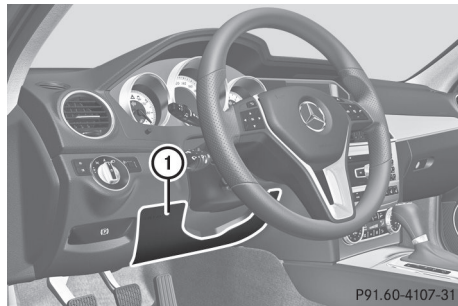

Driver's knee bag ① provides additional protection for the driver against:

- knee injuries
- thigh injuries
- lower leg injuries

Driver's knee bag ① deploys below the steering wheel. During a frontal impact, if the system determines that air bag deployment can offer additional protection to that provided by the seat belt, driver's knee bag ① is deployed along with the driver's air bag. The driver's knee bag ① operates best in conjunction with a properly positioned and fastened seat belt.

### Side impact air bags

#### WARNING

The pressure sensors for side impact air bag control are located in the doors. Do not modify any components of the doors or door trim panels including, for example, the addition of door speakers.

Improper repair work on the doors or the modification or addition of components to the doors create a risk of rendering the side impact air bags inoperative or causing unintended air bag deployment. Work on the doors must therefore only be performed by qualified technicians. Contact an authorized Mercedes-Benz Center.

**⚠ WARNING**

Only use seat covers which have been tested and approved by Mercedes-Benz for your vehicle model. Using seat covers or other seat coverings can cause a malfunction of the side impact air bags and/or the pelvis air bags. Contact an authorized Mercedes-Benz Center for availability.

When deployed, the side impact air bags offer additional protection for the thorax of the vehicle occupants on the side of the vehicle on which the impact occurs. However, they do not protect the:

- head
- neck
- arms

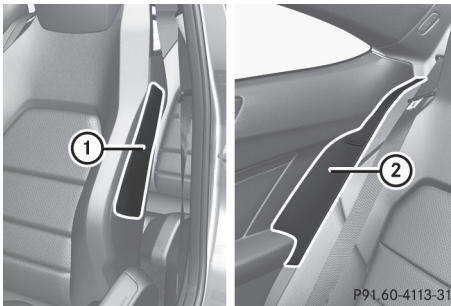

Front side impact air bags ① and rear side impact air bags ② deploy next to the outer seat cushions.

The side impact air bags are deployed:

- on the side on which an impact occurs
- at the start of an accident with a high rate of lateral vehicle deceleration or acceleration, e.g. in a side impact
- independently of the use of the seat belt
- independently of the front air bags
- independently of the ETDs

Side impact air bags will not deploy in side impacts which do not exceed the system's preset deployment thresholds for lateral acceleration/deceleration. You will then be protected by the fastened seat belt.

The side impact air bag on the front-passenger side will not deploy under the following conditions:

- the OCS detects that the front-passenger seat is not occupied.
- the front-passenger seat belt is not fastened.

The side impact air bag on the front-passenger side will deploy if the front-passenger seat belt is fastened, regardless of whether the front-passenger seat is occupied or not.

**Pelvis air bags****⚠ WARNING**

Only use seat covers which have been tested and approved by Mercedes-Benz for your vehicle model. Using seat covers or other seat coverings can cause a malfunction of the side impact air bags and/or the pelvis air bags. Contact an authorized Mercedes-Benz Center for availability.

Pelvis air bag deployment enhances the level of protection of the vehicle occupants on the side of the vehicle on which the impact occurs.

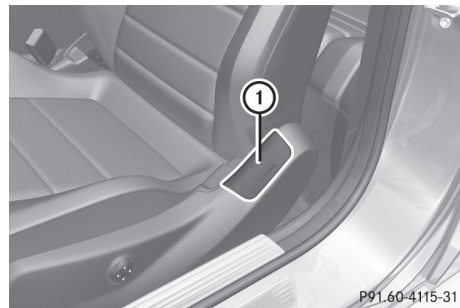

Pelvis air bags ① deploy next to and below the outer seat cushions. They are deployed:

- on the side on which an impact occurs
- at the start of an accident with a high rate of lateral vehicle deceleration or acceleration, e.g. in a side impact
- independently of the use of the seat belt

- independently of the front air bags
- independently of the ETDs

Pelvis air bags ① will not deploy in side impacts which do not exceed the system's preset deployment thresholds for lateral acceleration/deceleration. You will then be protected by the fastened seat belt.

The pelvis air bag on the front-passenger side will not deploy under the following conditions:

- the OCS detects that the front-passenger seat is not occupied.
- the front-passenger seat belt is not fastened.

The pelvis air bag on the front-passenger side will deploy if the front-passenger seat belt is fastened, regardless of whether the front-passenger seat is occupied or not.

### Window curtain air bags

The window curtain air bags enhance the level of protection for the head, but not chest or arms, of the vehicle occupants on the side of the vehicle on which the impact occurs.

The window curtain air bags are integrated into the side of the roof frame and deploy in the area extending from the front door (A-pillar) to the rear sidewall (C-pillar).

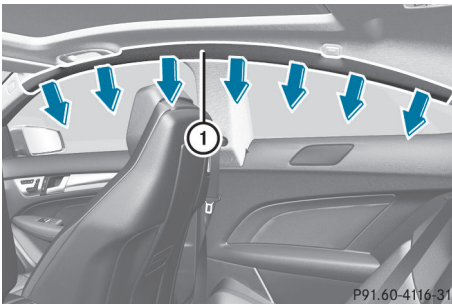

Window curtain air bags ① are deployed:

- on the side on which an impact occurs
- at the start of an accident with a high rate of lateral vehicle deceleration or acceleration, e.g. in a side impact

- regardless of whether the front-passenger seat is occupied
- independently of seat belt use
- independently of the front air bags

Window curtain air bags ① will not deploy in impacts with deceleration rates which do not exceed the system's preset deployment thresholds for vehicle deceleration or acceleration. You will then be protected by the fastened seat belt.

### Occupant Classification System (OCS)

#### How the Occupant Classification System works

The Occupant Classification System (OCS) categorizes the occupant on the front-passenger seat by means of a weight sensor.

The front-passenger front air bag is deactivated automatically for certain weight categories. The  indicator lamp shows you the current status. If the

 indicator lamp is illuminated, the front-passenger front air bag is deactivated.

The system does not deactivate:

- the side impact air bag
- the pelvis air bag
- the window curtain air bag
- the Emergency Tensioning Devices

To be classified correctly, the front passenger must sit:

- with the seat belt fastened correctly
- in a position that is as upright as possible with their back against the seat backrest
- with their feet on the floor

If the front-passenger's weight is transferred to another object in the vehicle (e.g. by leaning on armrests), OCS may not be able to approximate the occupant's weight category.

If the front-passenger seat, the seat cover or the seat cushion are damaged, have the





necessary repair work carried out at an authorized Mercedes-Benz Center.

For safety reasons, Mercedes-Benz recommends that you only use seat accessories that have been approved by Mercedes-Benz.

Both the driver and the passenger should always use the  indicator lamp as an indication of whether or not the passenger is properly positioned.

### WARNING

If the  indicator lamp illuminates when an adult or someone larger than a small individual is in the front passenger seat, have the front passenger reposition himself or herself in the seat until the  indicator lamp goes out.

In the event of a collision, the air bag control unit will not allow front passenger front air bag deployment when the OCS has classified the front passenger seat occupant as weighing as much as or less than a typical 12-month-old child in a standard child restraint or if the front passenger seat is classified as being empty.

When the OCS senses that the front passenger seat occupant is classified as being up to or less than the weight of a typical 12-month-old child in a standard child restraint, the  indicator lamp will illuminate when the engine is started and remain illuminated. This indicates that the front passenger front air bag is deactivated.

When the OCS senses that the front passenger seat is classified as being empty, the  indicator lamp will illuminate when the engine is started and remain illuminated. This indicates that the front passenger front air bag is deactivated.

When the OCS senses that the front passenger seat occupant is classified as being heavier than the weight of a typical 12-month-old child seated in a standard child restraint or as being a small individual (such as a young teenager or a small adult), the  indicator lamp will illuminate for

approximately 6 seconds when the engine is started. Depending on occupant weight sensor readings from the seat, it will then remain illuminated or go out. With the

 indicator lamp illuminated, the front passenger front air bag is deactivated.

With the  indicator lamp out, the front passenger front air bag is activated.

When the OCS senses that the front passenger seat occupant is classified as an adult or someone larger than a small individual, the  indicator lamp will illuminate for approximately six seconds when the engine is started and then go out. This indicates that the front passenger front air bag is activated.

If the  indicator lamp is illuminated, the front passenger front air bag is deactivated and will not be deployed.

If the  indicator lamp is not illuminated, the front passenger front air bag is activated and will be deployed

- in the event of certain frontal impacts
- if the impact exceeds a predetermined triggering threshold
- independent of the side impact air bag or pelvis air bag

If the front passenger front air bag is deployed, the rate of inflation will be influenced by

- the rate of vehicle deceleration as assessed by the air bag control unit
- the front passenger's weight category as identified by the OCS

For further information, see "Air bag display messages" (> page 193).

### WARNING



According to accident statistics, children are safer when properly restrained on the rear seats than on the front-passenger seat. Thus, we strongly recommend that children be placed in the rear seats whenever possible. Regardless of seating position, children 12 years old and under must be seated and

properly secured in an appropriate infant restraint, toddler restraint, or booster seat recommended for the size and weight of the child.

The infant or child restraint must be properly secured with the vehicle's seat belt, the seat belt and Top Tether strap, or lower anchors and Top Tether strap, fully in accordance with the child seat manufacturer's instructions.

Occupants, especially children, should always sit as upright as possible, wear the seat belt properly and use an appropriately sized infant restraint, toddler restraint, or booster seat recommended for the size and weight of the child.

Children can be killed or seriously injured by an inflating air bag. Note the following important information when circumstances require you to place a child in the front-passenger seat:

- Your vehicle is equipped with air bag technology designed to deactivate the front-passenger front air bag in your vehicle when the system senses the weight of a typical 12-month-old child or less along with the weight of a standard appropriate child restraint on the front-passenger seat.
- A child in a rear-facing child restraint on the front-passenger seat will be seriously injured or even killed if the front-passenger front air bag inflates in a collision which could occur under some circumstances, even with the air bag technology installed in your vehicle. The only means to eliminate this risk completely is never to place a child in a rear-facing child restraint in the front-passenger seat. We therefore strongly recommend that you always place a child in a rear-facing child restraint on the rear seat.
- If you install a rear-facing child restraint on the front-passenger seat, make sure the  indicator lamp is illuminated, indicating that the front-passenger front air bag is deactivated. Should the  indicator lamp not illuminate or go out while

the restraint is installed, please check installation. Periodically check the



indicator lamp while driving to make sure that the



indicator lamp is illuminated. If the  indicator lamp goes out or remains out, do not transport a child on the front-passenger seat until the system has been repaired.

A child in a rear-facing child restraint on the front-passenger seat will be seriously injured or even killed if the front-passenger front air bag inflates.

- If you place a child in a forward-facing child restraint on the front-passenger seat:
  - move the seat as far back as possible
  - use the proper child restraint recommended for the age, size and weight of the child
  - secure child restraint with the vehicle's seat belt according to the child seat manufacturer's instructions
- For children larger than the typical 12-month-old child, the front-passenger front air bag may or may not be activated.

If the driver's air bag deploys, this does not mean that the front-passenger front air bag will also deploy.

The OCS may have detected that the seat:

- is either empty or occupied by a person with a weight up to that of a typical twelve-month-old child seated in a standard child restraint
- is occupied by a small individual, such as a young teenager or a small adult
- is occupied by a child in a child restraint system, whose weight is greater than that of a typical twelve-month-old child.



These are examples of when the OCS deactivates the front-passenger front air bag. Deactivation takes place although the collision fulfills the criteria for deploying the driver's air bag.







P68.10-4328-31

If the SmartKey has been removed from the ignition lock or is in position **0**,

the  indicator lamp  does not light up.

### **WARNING**

If the red  SRS warning lamp in the instrument cluster and the  indicator lamp light up simultaneously, the OCS is malfunctioning. The front passenger front air bag will be deactivated in this case. Have the system checked by qualified technicians as soon as possible. Contact an authorized Mercedes-Benz Center.

Only have the seat repaired or replaced at an authorized Mercedes-Benz Center.

In order to ensure proper operation of the air bag system and OCS:

- Sit with the seat belt properly fastened in a position that is as upright as possible with your back against the seat backrest.
- When seated, a passenger should not position him/herself in such a way as to cause the passenger's weight to be lifted from the seat cushion as this may result in the OCS being unable to correctly approximate the passenger's weight category.
- Read and observe all warnings in this chapter.

## System self-test

The  indicator lamp illuminates when you:

- turn the SmartKey to position **1** or **2** in the ignition lock
- on vehicles with KEYLESS-GO, press the Start/Stop button once or twice

If an adult occupant is sitting properly on the front-passenger seat and the OCS classifies the occupant as an adult, the  indicator lamp will illuminate and go out again after approximately six seconds.

If the seat is not occupied and the OCS classifies the front passenger seat as being unoccupied, the  indicator lamp will illuminate and not go out.

### **WARNING**

If the  indicator lamp does not illuminate, the system is not functioning. You must contact an authorized Mercedes-Benz Center before seating any child on the front passenger seat.

For more information, see "Problems with the Occupant Classification System"

(> page 48).

### **WARNING**

Never place anything between seat cushion and child seat (e.g. a pillow), since it reduces the effectiveness of the OCS. The underside and rear side child restraint system must be placed entirely on the seat cushion and the backrest of the front-passenger seat backrest.

If necessary, adjust the tilt of the passenger seat backrest.



An incorrectly mounted child seat could cause injuries to the child in case of an accident, instead of increasing protection for the child. Follow the manufacturer's instructions for installation of child restraint systems.

### Problems with the Occupant Classification System

Problem	Possible causes/consequences and ► Solutions
<p>The  indicator lamp illuminates and remains illuminated. The person on the front-passenger seat:</p> <ul style="list-style-type: none"> <li>• has the weight of a typical adult</li> <li>• has been determined by the system not to be a child</li> </ul>	<p>The OCS is malfunctioning.</p> <ul style="list-style-type: none"> <li>► Have the OCS checked as soon as possible at an authorized Mercedes-Benz Center.</li> <li>► Observe the additional display messages in the multifunction display (► page 193).</li> </ul>

#### WARNING

If the  indicator lamp illuminates and remains illuminated when the weight of a typical adult or someone larger than a small individual has been detected on the passenger seat, do not allow any occupant to use the passenger seat until the system has been repaired.

Problem	Possible causes/consequences and ► Solutions
<p>The  indicator lamp does not illuminate and/or does not remain illuminated. The front-passenger seat is:</p> <ul style="list-style-type: none"> <li>• unoccupied</li> <li>• occupied with a weight up to that of a typical twelve-month-old child in a standard child restraint system</li> </ul>	<p>The OCS is malfunctioning.</p> <ul style="list-style-type: none"> <li>► Make sure there is nothing between the seat cushion and the child seat.</li> <li>► Check the installation of the child restraint system.</li> <li>► Make sure that no objects are applying additional weight onto the seat.</li> <li>► If the  indicator lamp does not illuminate, have the OCS checked as soon as possible at an authorized Mercedes-Benz Center. Do not transport a child on the front-passenger seat as long as the OCS is not functioning.</li> <li>► Observe the additional display messages in the multifunction display (► page 193).</li> </ul>

#### WARNING

If the  indicator lamp does not illuminate or remains out with the weight of a typical 12-month-old child in a standard child restraint or less, or is unoccupied, on the front-passenger seat, do not transport a child on the front-passenger seat until the system has been repaired.

### NECK-PRO head restraints

The NECK-PRO head restraints increase protection to the driver's and front passenger's head and neck. To this end, the NECK-PRO head restraints on the driver's and front-passenger seats are moved forwards and upwards in the event of a rear-end collision of a certain severity. This provides better head support.

#### WARNING

Do not secure any objects (e.g. coat hangers) on the NECK-PRO head restraints. Otherwise, the NECK-PRO head restraints may not function properly, or in the event of a rear-end collision may not be able to offer the level of protection they are designed to provide.

#### WARNING

Seat or head restraint covers can cause a malfunction when the NECK-PRO head restraints are activated or when the side impact air bags or pelvis air bags are deployed, or they can prevent this completely. The NECK-PRO head restraints or side impact air bags/pelvis air bags can therefore not provide the intended protection. Do not use any seat or head restraint covers.

If the NECK-PRO head restraints have been triggered in an accident, reset the NECK-PRO head restraints on the driver's and front-passenger seat (▷ page 49). Otherwise, the additional protection will not be available in the event of another rear-end collision. You can recognize when NECK-PRO head restraints have been triggered by the fact that they have moved forwards and can no longer be adjusted.

#### WARNING

For your protection, drive only with properly positioned head restraints.

Adjust the head restraint so that it is as close to the head as possible and the center of the head restraint supports the back of the head at eye level. This will reduce the potential for

injury to the head and neck in the event of an accident or similar situation.

### Resetting triggered NECK-PRO head restraints

#### WARNING

For safety reasons, have the NECK-PRO head restraints checked at an authorized Mercedes-Benz Center after a rear-end collision.

#### WARNING

When pushing back the NECK-PRO head restraint cushion, make sure your fingers do not become caught between the head restraint cushion and the cover. Failure to observe this could result in injuries.

- i** Resetting the NECK-PRO head restraints requires a lot of strength. If you have difficulty resetting the NECK-PRO head restraints, have this work carried out at a qualified specialist workshop, e.g. an authorized Mercedes-Benz Center.

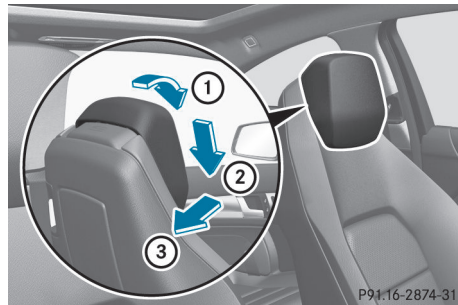

- ▶ Tilt the top of the NECK-PRO head restraint cushion forwards in the direction of arrow ①.
- ▶ Push the NECK-PRO head restraint cushion down in the direction of arrow ② as far as it will go.

- ▶ Firmly push the NECK-PRO head restraint cushion back in the direction of arrow ③ until the cushion engages.
- ▶ Repeat this procedure for the second NECK-PRO head restraint.

## Seat belts

### Important safety notes

The use of seat belts and infant and child restraint systems is required by law in all 50 states, the District of Columbia, the U.S. territories and all Canadian provinces.

Even where this is not the case, all vehicle occupants should have their seat belts fastened when the vehicle is in motion.

- ❗ For further information on infants and children traveling in the vehicle and on infant and child restraint systems, see "Children in the vehicle" (> page 54).

#### WARNING

Always fasten your seat belt before driving off. Always make sure all of your passengers are properly restrained. You and your passengers should always wear seat belts.

Failure to wear and properly fasten and position your seat belt greatly increases your risk of injuries and their likely severity in an accident.

If you are ever in an accident, your injuries can be considerably more severe without your seat belt properly buckled. Without your seat belt buckled, you are much more likely to hit the interior of the vehicle or be ejected from it. You can be seriously injured or killed.

In the same crash, the possibility of injury or death is lessened if you are properly wearing your seat belt. The air bags can only protect as intended if the occupants are properly wearing their seat belts.

#### WARNING

Never ride in a moving vehicle with the seat backrest in an excessively reclined position as

this can be dangerous. You could slide under the seat belt in a collision. If you slide under it, the seat belt would apply force at the abdomen or neck. That could cause serious or even fatal injuries. The seat backrest and seat belt provide the best restraint when the wearer is in a position that is as upright as possible and the seat belt is properly positioned on the body.

#### WARNING

Never let more people ride in the vehicle than there are seat belts available. Make sure everyone riding in the vehicle is correctly restrained with a separate seat belt. Never use a seat belt for more than one person at a time.

#### WARNING

Damaged seat belts or seat belts that have been subjected to stress in an accident must be replaced and their anchoring points must also be checked.

Only use seat belts which have been approved by Mercedes-Benz.

Do not make any modifications to the seat belts. This can lead to unintended activation of the ETDs or to their failure to activate when necessary.

Do not bleach or dye seat belts as this may severely weaken them. In a crash they may not be able to provide adequate protection.

Have all work carried out only by qualified technicians. Contact an authorized Mercedes-Benz Center.

### Correct use of the seat belts

#### WARNING

#### USE SEAT BELTS PROPERLY

- Seat belts can only work when used properly. Never wear seat belts in any other way than as described in this section, as

that could result in serious injuries in the event of an accident.

- Each occupant should wear their seat belt at all times, because seat belts help reduce the likelihood of and potential severity of injuries in accidents, including rollovers. The integrated restraint system includes SRS (driver front air bag, driver's side knee bag, front-passenger front air bag, side impact air bags, pelvis air bags, window curtain air bags for the side windows), Emergency Tensioning Devices, seat belt force limiters, and front seat knee bolsters. The system is designed to enhance the protection offered to properly belted occupants in certain frontal (front air bags, driver's side knee bag, and ETDs) and side (side impact air bags, pelvis air bags, window curtain air bags, and ETDs) impacts which exceed preset deployment thresholds.
- Never wear the shoulder belt under your arm, across your neck or off your shoulder. In a frontal crash, your body would move too far forward. That would increase the chance of head and neck injuries. The seat belt would also apply too much force to the ribs or abdomen, which could severely injure internal organs such as your liver or spleen.

Adjust the seat belt so that the shoulder section is located as close as possible to the middle of the shoulder. It should not touch the neck. Never pass the shoulder portion of the seat belt under your arm.

- Position the lap belt as low as possible on your hips and not across the abdomen. If the lap belt is positioned across your abdomen, it could cause serious injuries in a crash.
- Never wear seat belts over rigid or breakable objects in or on your clothing, such as eyeglasses, pens, keys etc., as these might cause injuries.

- Make sure the seat belt is always fitted snugly. Take special care of this when wearing loose clothing.
- Never use a seat belt for more than one person at a time. Do not fasten a seat belt around a person and another person or other objects at the same time.
- Seat belts should not be worn twisted. In a crash, you would not have the full width of the seat belt to distribute impact forces. The twisted seat belt against your body could cause injuries.
- Pregnant women should also always use a lap-shoulder belt. The lap belt portion should be positioned as low as possible on the hips to avoid any possible pressure on the abdomen.
- Place the seat backrest in a position that is as upright as possible.
- Check your seat belt during travel to make sure it is properly positioned.
- Never place your feet on the instrument panel, dashboard, or on the seat. Always keep both feet on the floor in front of the seat.
- When using a seat belt to secure infant restraints, toddler restraints, or children in booster seats, always follow the child seat manufacturer's instructions.

#### WARNING

Do not pass seat belts over sharp edges. They could tear.

Do not allow the seat belt to get caught in the door or in the seat adjustment mechanism. This could damage the seat belt.

Never attempt to make modifications to seat belts. This could impair the effectiveness of the seat belts.

### Fastening seat belts

#### WARNING

According to accident statistics, children are safer when properly restrained on the rear

seats than on the front-passenger seat. Thus, we strongly recommend that children be placed in the rear seat whenever possible. Regardless of seating position, children 12 years old and under must be seated and properly secured in an appropriately sized child restraint system or booster seat recommended for the size and weight of the child. For additional information, see the "Children in the vehicle" section.

A child's risk of serious or fatal injuries is significantly increased if the child restraints are not properly secured in the vehicle and/or the child is not properly secured in the child restraint.

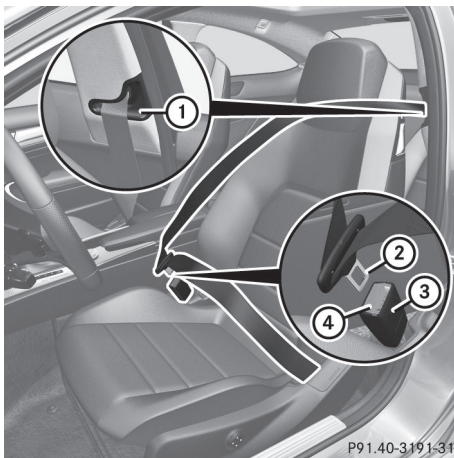

- ▶ Adjust the seat and move the backrest to an almost vertical position (▷ page 86).
- ▶ Pull the seat belt smoothly through belt sash guide ①.
- ▶ Without twisting it, guide the shoulder section of the seat belt across the middle of your shoulder and the lap section across your hips.
- ▶ Engage belt tongue ② in buckle ③.
- ▶ If necessary, pull upwards on the shoulder section of the seat belt to tighten the belt across your body.

All seat belts except the driver's seat belt are equipped with a special seat belt retractor to

securely fasten child restraint systems in the vehicle. For further information about special seat belt retractors, see (▷ page 56).

For more information about releasing the seat belt with release button ④, see "Releasing seat belts" (▷ page 52).

### Releasing seat belts

- ▶ Press release button ④ (▷ page 51) and guide belt tongue ② back towards belt sash guide ①.
- ❗ If you have guided the seat belt back, it is turned 180°. This is necessary in order to guarantee that the seat belt is not twisted and that it is routed correctly when the belt is fastened.
- ❗ Make sure that the seat belt is fully rolled up. Otherwise, the seat belt or belt tongue will be trapped in the door or in the seat mechanism. This could damage the door, the door trim panel and the seat belt. Damaged seat belts can no longer fulfill their protective function and must be replaced. Visit a qualified specialist workshop.

### Belt warning for the driver and front passenger

Regardless of whether the driver's and front-passenger seat belts have already been fastened, the  seat belt warning lamp will light up for six seconds each time the engine is started. It then goes out if the driver and the front passenger have fastened their seat belts.

If the driver's seat belt is not fastened when the engine is started, an additional warning tone will sound. The warning tone goes out after approximately six seconds or once the driver's seat belt is fastened.

If after six seconds the driver's or front-passenger seat belt is not fastened and the doors are closed, the  seat belt warning lamp will remain lit:

- until the driver's or front passenger's seat belt is fastened
- once the vehicle has exceeded a speed of 15 mph (25 km/h), in addition a warning tone will sound with increasing intensity for up to 60 seconds or until the driver's or front-passenger seat belt is fastened.

If the driver or front passenger unfastens their seat belt during the journey, the  seat belt warning lamp lights up and the warning tone sounds again.

The warning tone ceases after 60 seconds even if the driver or front passenger has still not fastened their seat belt. The  seat belt warning lamp stops flashing, but remains lit.

After the vehicle has come to a stop, the warning tone will be reactivated and the  seat belt warning lamp will flash again once the vehicle has exceeded a speed of 15 mph (25 km/h).

The  seat belt warning lamp will not go out until:

- both the driver and the front passenger have fastened their seat belts.
- or
- the vehicle is stationary and a door is open.

**i** For more information on the  seat belt warning lamp, see "Warning and indicator lamps in the instrument cluster, seat belt" (▷ page 210).

### Emergency Tensioning Devices, belt force limiters

The seat belts are equipped with ETDs and seat belt force limiters.

The ETDs tighten the seat belts in an accident, pulling them close against the body.

The ETDs do not correct incorrect seat positions or incorrectly fastened seat belts.

The ETDs do not pull vehicle occupants back towards the backrest.

Seat belt force limiters, when triggered, help to reduce the peak force exerted by the seat belt on the vehicle occupant.

The seat belt force limiters for the front seats are synchronized with the front air bags. These take on a part of the deceleration force. Thus, the force exerted on the occupant is distributed over a greater area.

The ETDs can only be activated when:

- the ignition is switched on.
- the restraint systems are operational; see "SRS warning lamp" (▷ page 38).
- the belt tongue is engaged in the buckle on each of the lap-shoulder belts in the front.
- the front-passenger seat is occupied and the belt tongue is engaged in the buckle on the front-passenger side.

The ETDs on the seats in the rear compartment are triggered independently of the lock status of the seat belts.

The ETDs are triggered depending on the type and severity of an accident:

- if, in the event of a head-on or rear-end collision, the vehicle decelerates or accelerates rapidly in a longitudinal direction during the initial stages of the impact
- if, in the event of a side impact, on the side opposite the impact the vehicle decelerates or accelerates rapidly in a lateral direction

If the Emergency Tensioning Devices (ETDs) are triggered, you will hear a bang, and a small amount of smoke may also be released. Only in rare cases will the bang affect your hearing. The smoke that is released generally does not constitute a health hazard. The  SRS warning lamp lights up.

#### WARNING

Pyrotechnic ETDs that were activated must be replaced.



For your safety, when disposing of the pyrotechnic ETDs always follow our safety instructions. These are available at any authorized Mercedes-Benz Center.

- ❗ If the front-passenger seat is not occupied, do not engage the seat belt tongue in the buckle on the front-passenger seat. Otherwise, the Emergency Tensioning Device could be triggered in the event of an accident.

## Children in the vehicle

### Child restraint systems

#### Important safety notes

We recommend that all infants and children be properly secured in an infant or child restraint system at all times while the vehicle is in motion.

The use of seat belts and infant and child restraint systems is required by law in all 50 states, the District of Columbia, the U.S. territories and all Canadian provinces.

Infants and children must always be seated in an appropriate infant or child restraint system recommended for the size and weight of the child. The infant or child restraint system must be properly secured in accordance with the manufacturer's instructions. All infant or child restraint systems must comply with U.S. Federal Motor Vehicle Safety Standards 213 and 225 and Canadian Motor Vehicle Safety Standards 213 and 210.2.

An information label on the child restraint system indicates whether it meets these standards. This information is also provided in the installation instructions supplied with the child restraint system.

Always read and follow the manufacturer's instructions when using an infant or child restraint system or booster seat.

Observe all warning signs in the vehicle interior and on the infant or child restraint.

#### WARNING

According to accident statistics, children are safer when properly restrained in the rear seating positions than in the front seating position. Thus, we strongly recommend that children be placed in the rear seats whenever possible. Regardless of seating position, children 12 years old and under must be seated and properly secured in an appropriate infant restraint, toddler restraint, or booster seat recommended for the size and weight of the child.

The infant or child restraint must be properly secured with the vehicle's seat belt, the seat belt and top tether strap, or lower anchors and top tether strap, fully in accordance with the child seat manufacturer's instructions.





Occupants, especially children, should always sit as upright as possible, wear the seat belt properly and use an appropriately sized infant restraint, toddler restraint, or booster seat recommended for the size and weight of the child.

Children can be killed or seriously injured by an inflating air bag. Note the following important information when circumstances require you to place a child in the front passenger seat:

- Your vehicle is equipped with air bag technology designed to deactivate the front passenger front air bag in your vehicle when the system senses the weight of a typical 12-month-old child or less along with the weight of a standard appropriate child restraint on the front passenger seat.
- For children larger than the typical 12-month-old child, the front passenger front air bag may or may not be activated. Always make sure the  indicator lamp is illuminated, indicating that the front passenger front air bag is deactivated.
- A child in a rear-facing child restraint on the front passenger seat will be seriously injured or even killed if the front passenger front air bag inflates in a collision which could occur under some circumstances,



even with the air bag technology installed in your vehicle. The only means to completely eliminate this risk is to never place a child in a rear-facing child restraint in the front seat. We therefore strongly recommend that you always place a child in a rear-facing child restraint in a backseat.

- If you must install a rear-facing child restraint on the front passenger seat because circumstances require you to do so, make sure the  indicator lamp is illuminated, indicating that the front passenger front air bag is deactivated. Should the  indicator lamp not illuminate or go out while the restraint is installed, please check installation. Periodically check the  indicator lamp while driving to make sure the  indicator lamp is illuminated. If the  indicator lamp goes out or remains out, do not transport a child on the front passenger seat until the system has been repaired.

A child in a rear-facing child restraint on the front passenger seat will be seriously injured or even killed if the front passenger front air bag inflates.

- If you have to place a child in a forward-facing child restraint on the front passenger seat, move the seat as far back as possible, use the proper child restraint recommended for the age, size and weight of the child, and secure child restraint with the vehicle's seat belt according to the child seat manufacturer's instructions.

### WARNING

Infants and small children should never share a seat belt with another occupant. In the event of an accident, they could be crushed between the occupant and seat belt.

A child's risk of serious or fatal injuries is significantly increased if the child restraints are not properly secured in the vehicle and/or the child is not properly secured in the child restraint.

Children that are too large for a child restraint must travel in seats using normal seat belts. Position the shoulder belt across the chest and shoulder, not face or neck. A booster seat may be necessary to achieve proper seat belt positioning for children over 41 lb (18 kg) until they reach a height where a lap-shoulder belt fits properly without a booster.

When the child restraint is not in use, remove it from the vehicle or secure it with the seat belt to prevent the child restraint from becoming a projectile in the event of an accident.

If an infant or child is traveling in the vehicle:

- ▶ Secure the infant or child with an appropriate infant or child restraint recommended for the child's age and weight.
- ▶ Make sure that the infant or child is properly secured at all times while the vehicle is in motion.

### WARNING

When leaving the vehicle, always remove the SmartKey from the ignition lock. Always take the SmartKey with you and lock the vehicle. Do not leave children unattended in the vehicle, even if they are secured in a child restraint system, or with access to an unlocked vehicle. A child's unsupervised access to a vehicle could result in an accident and/or serious personal injury. The children could:

- injure themselves on parts of the vehicle
- be seriously or fatally injured through excessive exposure to extreme heat or cold
- injure themselves or cause an accident with vehicle equipment that can be operated even if the SmartKey is removed from the ignition lock or removed from the vehicle, such as seat adjustment, steering wheel adjustment, or the memory function

If children open a door, they could injure other persons or get out of the vehicle and injure themselves or be injured by following traffic.

Do not expose the child restraint system to direct sunlight. The child restraint system's metal parts, for example, could become very hot, and the child could be burned on these parts.

 **WARNING**

Do not carry heavy or hard objects in the passenger compartment or trunk unless they are firmly secured in place.

Unsecured or improperly positioned cargo increases a child's risk of injury in the event of

- strong braking maneuvers
- sudden changes of direction
- an accident

### Special seat belt retractor

All seat belts except the driver's seat belt are equipped with a special seat belt retractor. When activated, the special seat belt retractor ensures the seat belt will not slacken once the child restraint system has been secured.

Installing a child restraint system:

- ▶ Always comply with the manufacturer's installation instructions.
- ▶ Pull the seat belt smoothly from the inertia reel.
- ▶ Engage the seat belt tongue in the belt buckle.

Activating the special seat belt retractor:

- ▶ Pull the seat belt out fully and let the inertia reel retract it again. While the seat belt is retracting, you should hear a ratcheting sound. The special seat belt retractor is enabled.
- ▶ Push down on the child restraint system to take up any slack.

Removing a child restraint system/  
deactivating the special seat belt retractor:

- ▶ Always comply with the manufacturer's installation instructions.
- ▶ Press the seat belt release button and guide the belt tongue to the belt outlet. The special seat belt retractor is deactivated.

 **WARNING**

Never release the seat belt buckle while the vehicle is in motion, since the special seat belt retractor will be deactivated.

### LATCH-type (ISOFIX) child seat anchors in the rear

 **WARNING**

Children that are too large for a child restraint must travel in seats using normal seat belts. Position shoulder belt across the chest and shoulder, not face or neck.

A booster seat may be necessary to achieve proper seat belt positioning for children over 41 lb (18 kg) until they reach a height where a lap/shoulder belt fits properly without a booster.

Install the child restraint system in accordance with the manufacturer's instructions.

Attach the child restraint system to both securing rings.

An incorrectly installed child restraint system could come loose during an accident and seriously or even fatally injure the child.

Child restraint systems or child seat securing rings that are malfunctioning or damaged as the result of a collision must be replaced.

ISOFIX is a standardized securing system for specially designed child restraint systems on the rear seats. Securing rings for two LATCH-type (ISOFIX) child restraint systems are installed on the left and right of the rear seats. Secure non-LATCH-type (ISOFIX) child restraint systems using the vehicle's seat belt

system. Always install child restraint systems according to the manufacturer's instructions. The securing rings on the rear seats are covered by an upholstered lining.

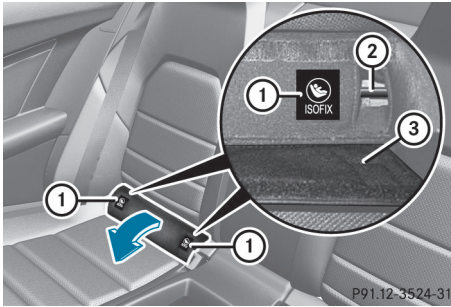

Installation instructions ① indicate the installation location of securing rings ②.

- ▶ Fold upholstery cover ③ and the Velcro fastener down.
- ▶ Install the LATCH-type (ISOFIX) child restraint systems on both securing rings ②. Comply with the manufacturer's instructions when installing the LATCH-type (ISOFIX) child restraint system.

### Top Tether

#### **WARNING**

Always lock the rear seat backrests in their upright position when the rear seats are occupied by passengers. Lock the rear seat backrests in their upright position before installing the Top Tether straps or when the cargo compartment is not in use. Make sure that rear seat backrests are secured properly by pushing and pulling on the seat backrests. If the seat backrest is not locked properly, the seat backrest could fold forward. The child restraint system is no longer supported properly or held in position and can no longer fulfill its function. This could cause serious or even fatal injuries.

Top Tether provides an additional connection between the child restraint system secured

with ISOFIX and the rear seat. It helps reduce the risk of injury even further.

The Top Tether anchorage points are located in the rear compartment behind the head restraints.

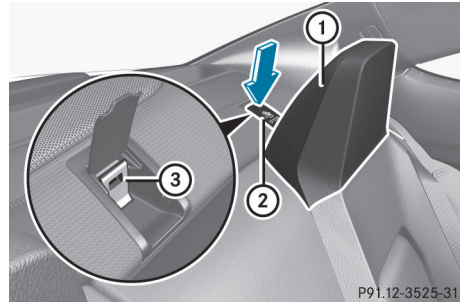

- ▶ Press down the rear of cover ② in the direction of the arrow. Cover ② is raised slightly at the front.
- ▶ Fold up cover ② of Top Tether anchorage ③.

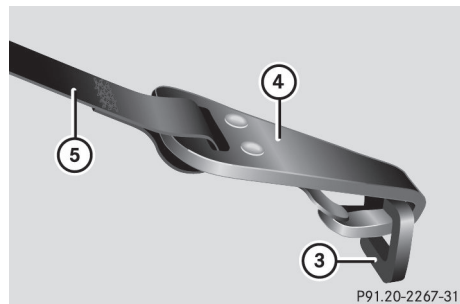

- ▶ Hook Top Tether hook ④ into Top Tether anchorage ③.
- ▶ In accordance with the model, the specification and the manufacturer's installation instructions, guide Top Tether belt ⑤ to the right and to left past the head restraints ①.

or

- ▶ Route Top Tether belt ⑤ over the center of the head restraint.

- ▶ Make sure that Top Tether belt ⑤ is not twisted.
- ▶ Install the LATCH-type (ISOFIX) child restraint system with Top Tether. Comply with the manufacturer's installation instructions when doing so. Make sure that Top Tether belt ⑤ is tight.

### Panic alarm



- ▶ **To activate:** press **PANIC** button ① for at least one second.  
An alarm sounds and the exterior lighting flashes.
  - ▶ **To deactivate:** press **PANIC** button ① again.
- or
- ▶ Insert the SmartKey into the ignition lock.
- or
- ▶ Press the KEYLESS-GO Start/Stop button.  
The KEYLESS-GO key must be in the vehicle.

#### **i** USA only:

This device complies with Part 15 of the FCC Rules. Operation is subject to the following two conditions:

1. This device may not cause harmful interference, and
2. this device must accept any interference received, including interference that may cause undesired operation.

Any unauthorized modification to this device could void the user's authority to operate the equipment.

The product label with FCC ID and IC certification number can be found in the battery case of the SmartKey.

#### **i** Canada only:

This device complies with RSS-Gen of Industry Canada. Operation is subject to the following two conditions:

1. This device may not cause interference, and
2. this device must accept any interference received, including interference that may cause undesired operation.

Any unauthorized modification to this device could void the user's authority to operate the equipment.

The product label with FCC ID and IC certification number can be found in the battery case of the SmartKey.

## Driving safety systems

### Driving safety systems overview

In this section, you will find information about the following driving safety systems:

- ABS (**A**nti-lock **B**raking **S**ystem)
- BAS (**B**rake **A**ssist **S**ystem)
- ESP® (**E**lectronic **S**tability **P**rogram)
- EBD (**E**lectronic **B**rake force **D**istribution)
- ADAPTIVE BRAKE

### Important safety notes

If you fail to adapt your driving style, the driving safety systems can neither reduce the risk of accident nor override the laws of physics. Driving safety systems are merely aids designed to assist driving. You are responsible for the distance to the vehicle in front, for vehicle speed and for braking in good time. Always adapt your driving style to suit the prevailing road/weather conditions,

as well as the traffic conditions and maintain a safe distance to the vehicle in front. Drive carefully.

- i** Please note that the driving safety systems described only work as effectively as possible when there is adequate contact between the tires and the road surface. Pay particular attention to the information regarding tires, recommended minimum tire tread depths etc. in the "Wheels and tires" section (▷ page 276).  
In wintry driving conditions, always use winter tires (M+S tires) and if necessary, snow chains. Only in this way will the driving safety systems described in this section work as effectively as possible.

### ABS (Anti-lock Braking System)

#### Important safety notes

- i** Observe the "Important safety notes" section (▷ page 58).

ABS regulates brake pressure in such a way that the wheels do not lock when you brake. This allows you to continue steering the vehicle when braking.

ABS works from a speed of about 5 mph (8 km/h) upwards, regardless of road-surface conditions. ABS works on slippery surfaces, even if you only brake gently.

#### WARNING

If the ABS malfunctions, other driving systems such as the BAS or the ESP® are also switched off. Observe indicator and warning lamps that may come on as well as messages in the multifunction display that may appear.

If the ABS malfunctions, the wheels may lock during hard braking, reducing the steering capability and extending the braking distance.

The  warning lamp in the instrument cluster lights up when the ignition is switched on. It goes out when the engine is running.

### Brakes

If ABS intervenes when braking, you will feel a pulsing in the brake pedal.

- ▶ **If ABS intervenes:** continue to depress the brake pedal vigorously until the braking situation is over.
- ▶ **To make a full brake application:** depress the brake pedal with full force.

The pulsating brake pedal can be an indication of hazardous road conditions, and functions as a reminder to take extra care while driving.

#### WARNING

Do not pump the brake pedal. Use firm, steady brake pedal pressure instead. Pumping the brake pedal defeats the purpose of the ABS and significantly reduces braking effectiveness.

### BAS (Brake Assist System)

- i** Observe the "Important safety notes" section (▷ page 58).

BAS operates in emergency braking situations. If you depress the brake pedal quickly, BAS automatically boosts the braking force, thus shortening the stopping distance.

- ▶ Keep the brake pedal firmly depressed until the emergency braking situation is over. ABS prevents the wheels from locking.

The brakes will function as usual once you release the brake pedal. BAS is deactivated.

#### WARNING

If the BAS malfunctions, the brake system still functions, but without the additional brake boost available that the BAS would normally provide in an emergency braking maneuver. Therefore, the braking distance may increase.

**ESP® (Electronic Stability Program)****Important safety notes**

- i** See the "Important safety notes" section (▷ page 58).

If ESP® detects that the vehicle is deviating from the direction desired by the driver, one or more wheels are braked to stabilize the vehicle. If necessary, the engine output is also modified to keep the vehicle on the desired course within physical limits. ESP® assists the driver when pulling away on wet or slippery roads. ESP® can also stabilize the vehicle during braking.

If ESP® intervenes, the  ESP® warning lamp flashes in the instrument cluster.

**⚠ WARNING**

Under no circumstances should you deactivate ESP® when the  ESP® warning lamp in the instrument cluster flashes. Proceed as follows:

- when driving off, apply as little throttle as possible.
- while driving, ease up on the accelerator pedal.
- adapt your speed to suit the prevailing road and weather conditions.

Failure to observe these guidelines could cause the vehicle to skid. ESP® cannot prevent accidents resulting from excessive speed.

- !** Vehicles with 4MATIC: switch off the ignition when the parking brake is being tested on a brake dynamometer.

Application of the brakes by ESP® may otherwise destroy the brake system.

Observe the notes on ESP® under "Towing and tow starting" (▷ page 270).

- i** Only use wheels with the recommended tire sizes. Only then will ESP® function properly.

**ETS/4ETS (Electronic Traction System)**

- i** Observe the "Important safety notes" section (▷ page 58).

Traction control is part of ESP®.

Traction control brakes the drive wheels individually if they spin. This enables you to pull away and accelerate on slippery surfaces, for example if the road surface is slippery on one side. On vehicles with 4MATIC, more drive torque is also transferred to the wheel or wheels with traction.

Traction control remains active if you deactivate ESP®.

**Deactivating/activating ESP® (except AMG vehicles)****⚠ WARNING**

ESP® should not be deactivated during normal driving other than in the circumstances described below. Disabling the system will reduce vehicle stability in driving maneuvers.

Do not deactivate ESP® when the emergency or spare wheel is mounted.

ESP® is activated automatically when the engine is started.

It may be best to deactivate ESP® in the following situations:

- when using snow chains
- in deep snow
- on sand or gravel

**⚠ WARNING**

Switch on ESP® immediately if one of the previously stated conditions is no longer met. Otherwise, ESP® cannot stabilize the vehicle if it begins to lurch or when a wheel spins.

If you deactivate ESP®:

- ESP® no longer improves driving stability.
- engine torque is not limited and the drive wheels are able to spin. The spinning

wheels produce a cutting effect for better traction.

- traction control is still activated.
- ESP® still provides support when you brake.



If ESP® is deactivated and one or more wheels start to spin, the  ESP® warning lamp in the instrument cluster flashes. In such situations, ESP® will not stabilize the vehicle.

► **To deactivate:** (> page 176).

The  ESP® OFF warning lamp in the instrument cluster lights up.

#### **WARNING**

When the  ESP® OFF warning lamp is lit, ESP® is deactivated.

If the  ESP® warning lamp and the  ESP® OFF warning lamp remain lit, ESP® is not available due to a malfunction.

When ESP® is deactivated or not operational, vehicle stability in standard driving maneuvers is reduced.

Adapt your speed and driving to the prevailing road conditions and to the non-operating status of the ESP®.

 **!** Avoid spinning the driven wheels for an extended period with ESP® deactivated. You could otherwise damage the drivetrain.

► **To activate:** (> page 176).

The  ESP® OFF warning lamp in the instrument cluster goes out.

### Deactivating/activating ESP® (AMG vehicles)

#### Activating/deactivating SPORT handling mode

#### **WARNING**

The SPORT handling mode should not be switched on during normal driving.

Switching on the SPORT handling mode will result in the following:

- no restriction to the engine torque
- system supported traction control is limited

The SPORT handling mode is designed for driving on closed tracks when the vehicle's own natural oversteer and understeer characteristics are desired and requires a highly skilled and experienced driver able to handle these critical driving situations.

You could lose control of your vehicle and cause an accident.

Please be aware of these limits when you switch on the SPORT handling mode.

Do not switch on the SPORT handling when a spare wheel is mounted.

ESP® is activated automatically when the engine is started.

It may be best to activate SPORT handling mode in the following situations:

- when using snow chains
- in deep snow
- on sand or gravel

#### **WARNING**

Switch off the SPORT handling mode and switch on the ESP® immediately if the aforementioned circumstances do not apply anymore. Otherwise the SPORT handling mode will only stabilize the vehicle to a limited extent when it is starting to skid or a wheel is spinning.

When SPORT handling mode is activated:

- ESP® only improves driving stability to a limited degree.
- engine torque is only restricted to a limited degree, and the drive wheels are able to spin. The spinning wheels produce a cutting effect for better traction.
- traction control is still activated.
- ESP® still provides support when you brake firmly.



If SPORT handling mode is activated and one or more wheels start to spin, the  ESP<sup>®</sup> warning lamp in the instrument cluster flashes. ESP<sup>®</sup> only stabilizes the vehicle to a limited degree.



P54.25-8684-31

► **To activate:** briefly press button ①.

The **SPORT** SPORT handling mode warning lamp in the instrument cluster lights up. The **SPORT handling mode** message appears in the multifunction display.

► **To deactivate:** briefly press button ①.

The **SPORT** SPORT handling mode warning lamp in the instrument cluster goes out.

### Deactivating/activating ESP<sup>®</sup>

#### **WARNING**

The ESP<sup>®</sup> should not be switched off during normal driving.

Disabling of the system will result in the following:

- no restriction to engine torque
  - loss of system-supported traction control
- "ESP<sup>®</sup> OFF" is designed for driving on closed tracks when the vehicle's natural oversteer and understeer characteristics are desired and requires a highly skilled and experienced driver able to handle these critical driving situations.

You could lose control of your vehicle and cause an accident.

Please be aware of these limits when you switch off the ESP<sup>®</sup>.

Do not switch off the ESP<sup>®</sup> when a spare wheel is mounted.

ESP<sup>®</sup> is activated automatically when the engine is started.

It may be best to deactivate ESP<sup>®</sup> in the following situations:

- when using snow chains
- in deep snow
- on sand or gravel

#### **WARNING**

Switch on ESP<sup>®</sup> immediately if one of the previously stated conditions is no longer met. Otherwise, ESP<sup>®</sup> cannot stabilize the vehicle if it begins to lurch or when a wheel spins.

If you deactivate ESP<sup>®</sup>:

- ESP<sup>®</sup> no longer improves driving stability.
- engine torque is no longer limited and the drive wheels are able to spin. The spinning wheels produce a cutting effect for better traction.
- traction control is still activated.
- ESP<sup>®</sup> still provides support when you brake firmly.

If ESP<sup>®</sup> is deactivated and one or more wheels start to spin, the  ESP<sup>®</sup> warning lamp in the instrument cluster does not flash. In such situations, ESP<sup>®</sup> will not stabilize the vehicle.





P54.25-8684-31



- ▶ **To deactivate:** press button ① until the  ESP® OFF warning lamp lights up in the instrument cluster. The  OFF message appears in the multifunction display.

#### WARNING



When the  ESP® OFF warning lamp is lit, ESP® is deactivated.

If the  ESP® warning lamp and the  ESP® OFF warning lamp remain lit, ESP® is not available due to a malfunction.

When ESP® is deactivated or not operational, vehicle stability in standard driving maneuvers is reduced.

Adapt your speed and driving to the prevailing road conditions and to the non-operating status of the ESP®.

- ❗ Avoid spinning the driven wheels for an extended period with ESP® deactivated. You could otherwise damage the drivetrain.

- ▶ **To activate:** briefly press button ①. The  ESP® OFF warning lamp in the instrument cluster goes out. The  ON message appears in the multifunction display.

#### EBD (electronic brake force distribution)

- ❗ Observe the "Important safety notes" section (▷ page 58).

EBD monitors and controls the brake pressure on the rear wheels to improve driving stability while braking.

#### WARNING

If EBD has malfunctioned, the braking system remains available with full brake boosting effect. However, the rear wheels can still lock, e.g. under full braking. This could cause you to lose control of your vehicle and cause an accident. You should therefore adapt your

driving style to the different handling characteristics.

- ▶ Observe the notes on warning and indicator lamps (▷ page 213) as well as display messages (▷ page 188).

#### ADAPTIVE BRAKE

ADAPTIVE BRAKE enhances braking safety and offers increased braking comfort. In addition to the braking function, ADAPTIVE BRAKE also has the HOLD function (▷ page 149) and hill start assist (▷ page 128). For further information, see Driving tips (▷ page 143).

#### Theft deterrent locking system

##### Immobilizer

The immobilizer prevents your vehicle from being started without the correct SmartKey. When leaving the vehicle, always take the SmartKey with you and lock the vehicle. The engine can be started by anyone with a valid SmartKey that is left inside the vehicle.

- ▶ **To activate with the SmartKey:** remove the SmartKey from the ignition lock.
- ▶ **To activate with KEYLESS-GO:** switch the ignition off and open the driver's door.
- ▶ **To deactivate:** switch on the ignition.

- ❗ The immobilizer is always deactivated when you start the engine.

In the event that the engine cannot be started when the starter battery is fully charged, the immobilizer may be faulty. Contact an authorized Mercedes-Benz Center or call 1-800-FOR-MERCEdes (in USA) or 1-800-387-0100 (in Canada).

**ATA (anti-theft alarm system)**

A visual and audible alarm is triggered if the alarm system is armed and you open:

- a door
- the vehicle with the mechanical key
- the trunk lid
- the hood

The alarm is not switched off, even if you close the open door that has triggered it, for example.

**i** If the alarm stays on for more than 30 seconds, the mbrace (USA only) or TELE AID (Canada only) emergency call system initiates a call to the Customer Assistance Center automatically. The emergency call system initiates the call provided that:

- you have subscribed to the mbrace/TELE AID service.
- the mbrace/TELE AID service has been activated properly.
- the required mobile phone, power supply and GPS are available.

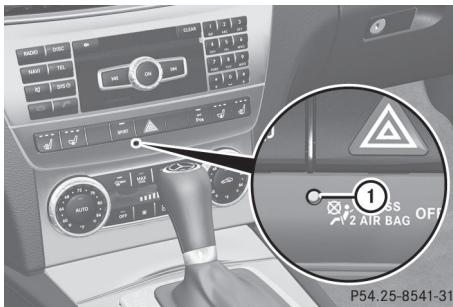



► **To arm:** lock the vehicle with the SmartKey or KEYLESS-GO.

Indicator lamp ① flashes. The alarm system is armed after approximately 15 seconds.

► **To disarm:** unlock the vehicle with the SmartKey or KEYLESS-GO.

► **To stop the alarm using the SmartKey:** insert the SmartKey into the ignition lock. The alarm is switched off.

or

► Press the  or  button on the SmartKey. The alarm is switched off.

► **To stop the alarm using KEYLESS-GO:** grasp the outside door handle. The SmartKey must be outside the vehicle. The alarm is switched off.

or

► Press the Start/Stop button on the dashboard. The SmartKey must be inside the vehicle. The alarm is switched off.

Useful information .....	66
SmartKey .....	66
Doors .....	72
Trunk .....	75
Side windows .....	78
Sliding sunroof .....	81

### Useful information

- i** This Operator's Manual describes all models and all standard and optional equipment of your vehicle available at the time of publication of the Operator's Manual. Country-specific differences are possible. Please note that your vehicle may not be equipped with all features described. This also applies to safety-related systems and functions.
- i** Please read the information on qualified specialist workshops (▷ page 23).

### SmartKey

#### Important safety notes

##### WARNING

When leaving the vehicle, always remove the SmartKey from the ignition lock. Always take the SmartKey with you and lock the vehicle. Do not leave children unsupervised in the vehicle, even if they are secured in a child restraint system, and do not give them access to an unlocked vehicle. A child's unsupervised access to a vehicle could result in an accident and/or serious personal injury. They could:

- injure themselves on vehicle parts
- be seriously or fatally injured by extreme heat or cold
- injure themselves or have an accident with vehicle equipment that may still be in operation even after the SmartKey has been removed from the ignition, such as the seat adjustment, steering wheel adjustment or memory function.

If children open a door, they could cause severe or even fatal injury to other persons; if they get out of the vehicle, they could injure themselves when doing so or be seriously or even fatally injured by any passing traffic.

Do not expose the child restraint system to direct sunlight. The child restraint system's metal parts, for example, could become very

hot, and a child could be burned on these parts.

##### WARNING

If a key ring is too heavy or too large, the weight acting on the key could cause it to turn in the ignition lock or catch on the steering wheel. This could cause the engine to be switched off suddenly. You may lose control of the vehicle and cause an accident. Do not attach any heavy or large key rings to the key that is inserted in the ignition.

#### General notes

If you cannot lock or unlock the vehicle with the SmartKey, either the battery in the SmartKey is discharged, the SmartKey is faulty or the starter battery is discharged.

- ▶ Check the battery in the SmartKey and replace it if necessary (▷ page 69).
- ▶ Unlock the driver's door using the mechanical key (▷ page 74).
- ▶ Lock the vehicle using the mechanical key (▷ page 74).
- ▶ Have the starter battery and the battery contacts checked at a qualified specialist workshop.

If the SmartKey is faulty, contact Roadside Assistance or a qualified specialist workshop.



#### SmartKey functions

The SmartKey centrally locks/unlocks:

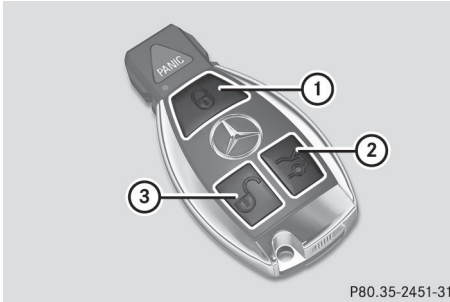
- the doors
- the trunk lid
- the fuel filler flap



P80.35-2451-31

- ①  Locks the vehicle
- ②  Unlocks the trunk lid
- ③  Unlocks the vehicle

When unlocking, the turn signals flash once. When locking, they flash three times.

When it is dark, the surround lighting also comes on if it is activated in the on-board computer (▷ page 179).

If you activate the acoustic locking confirmation function you will hear the following, depending on the date of production of the vehicle:

- an acoustic signal when locking or
- one acoustic signal when unlocking and three when locking.

The audible signal can be activated and deactivated using the on-board computer (▷ page 180).

► **To unlock centrally:** press the  button.

If you do not open the vehicle within approximately 40 seconds of unlocking:

- the vehicle is locked again.
- the theft deterrent locking system is armed again.

► **To lock centrally:** press the  button.

## KEYLESS-GO

### Important notes on the use of KEYLESS-GO

- Do not keep the KEYLESS-GO key together with:
  - electronic devices, e.g. a mobile phone or another key
  - metallic objects, e.g. coins or metal foil.
 This can affect the functionality of KEYLESS-GO.
- Bear in mind that the engine can be started by any of the vehicle occupants if there is a KEYLESS-GO key in the vehicle.

### Locking and unlocking centrally

You can start, lock or unlock the vehicle using KEYLESS-GO. To do this, you only need carry the SmartKey with you. You can combine the KEYLESS-GO functions with those of a conventional key, e.g. using KEYLESS-GO to unlock and pressing the  button to lock. When locking and unlocking using KEYLESS-GO, the distance between the SmartKey and the corresponding door handle must not exceed 3 ft (1 m).

KEYLESS-GO checks whether a valid key is in the vehicle by periodically establishing a radio connection between the vehicle and the key. This happens:

- when the external door handles are touched
- when starting the engine
- while the vehicle is in motion

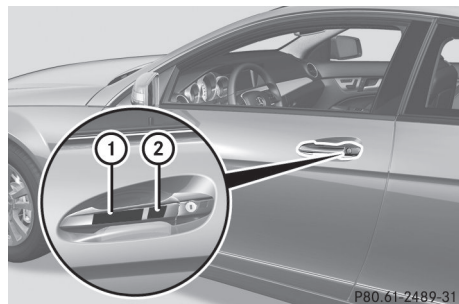





P80.61-2489-31

- ▶ **To unlock the vehicle:** touch the inner surface of the door handle.
- ▶ **To lock the vehicle:** touch sensor surface ①.
- ▶ **Convenience closing feature:** touch recessed sensor surface ② for an extended period (▷ page 80).



If you pull on the handle of the trunk lid, only the trunk of the vehicle is unlocked.

### Changing the settings of the locking system

You can change the setting of the locking system in such a way that only the driver's door and the fuel filler flap are unlocked. This is useful if you frequently travel on your own.

- ▶ **To change the setting:** press and hold down the  and  buttons simultaneously for approximately six seconds until the battery check lamp flashes twice (▷ page 69).
- ❗ If the setting of the locking system is changed within the signal range of the vehicle, pressing the  or  button locks or unlocks the vehicle.



The SmartKey now functions as follows:

- ▶ **To unlock the driver's door:** press the  button once.
- ▶ **To unlock centrally:** press the  button twice.
- ▶ **To lock centrally:** press the  button.

The KEYLESS-GO function is changed as follows:

- ▶ **To unlock the driver's door:** touch the inner surface of the door handle on the driver's door.
- ▶ **To unlock centrally:** touch the inner surface of the front-passenger door handle.
- ▶ **To lock centrally:** touch the outer sensor surface on one of the door handles.

### Restoring the factory settings

- ▶ Press the  and  buttons simultaneously for approximately six seconds until the battery check lamp flashes twice.



### Mechanical key

#### General notes

If the vehicle can no longer be locked or unlocked with the SmartKey, use the mechanical key.

If you use the mechanical key to unlock and open the driver's door or the trunk lid, the anti-theft alarm system will be triggered (▷ page 64).

There are several ways to turn off the alarm:

- ▶ **To turn the alarm off with the SmartKey:** press the  or  button on the SmartKey.
- or
- ▶ Insert the SmartKey into the ignition lock.
- or
- ▶ **To deactivate the alarm with KEYLESS-GO:** press the Start/Stop button in the ignition lock. The SmartKey must be in the vehicle.
- or
- ▶ Lock or unlock the vehicle using KEYLESS-GO. The SmartKey must be outside the vehicle.

If you unlock the vehicle using the mechanical key, the fuel filler flap will not be unlocked automatically.

- ▶ **To unlock the fuel filler flap:** insert the SmartKey in the ignition lock.

## Removing the mechanical key

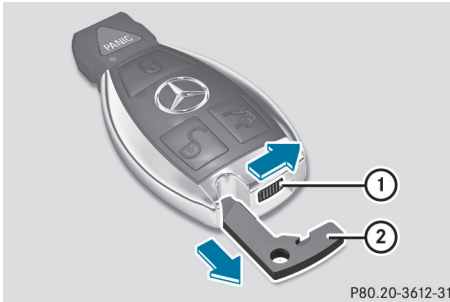

- ▶ Push release catch ① in the direction of the arrow and at the same time, remove mechanical key ② from the SmartKey.

### SmartKey battery

#### Important safety notes

Have the batteries changed at a qualified specialist workshop.

#### **⚠ WARNING**

Batteries contain toxic substances.

Swallowing batteries can lead to serious health issues or death.

Keep batteries out of the reach of children. Seek medical attention immediately if a battery is swallowed.

#### **⚠ WARNING**

The SmartKey batteries contain perchlorate material, which may require special handling and regard for the environment. Observe government disposal guidelines. California residents, see [www.dtsc.ca.gov/HazardousWaste/Perchlorate/index.cfm](http://www.dtsc.ca.gov/HazardousWaste/Perchlorate/index.cfm).

## Checking the battery



- ▶ Press the or button. The battery is working properly if battery check lamp ① lights up briefly

If battery check lamp ① does not light up briefly during the test, the battery is discharged.

- ▶ Changing the battery (▷ page 69)

**i** You can obtain the battery at a qualified specialist workshop.

**i** If the SmartKey battery is checked within the signal reception range of the vehicle, pressing the or button locks or unlocks the vehicle.

## Replacing the battery

You require a CR 2025 3 V cell battery.

- ▶ Take the mechanical key out of the SmartKey (▷ page 68).

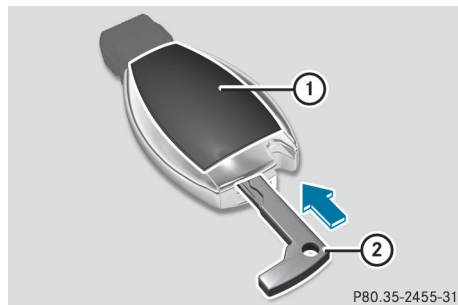

- ▶ Press mechanical key ② into the opening in the SmartKey in the direction of the



arrow until battery tray cover ① opens.  
When doing so, do not hold cover ① shut.



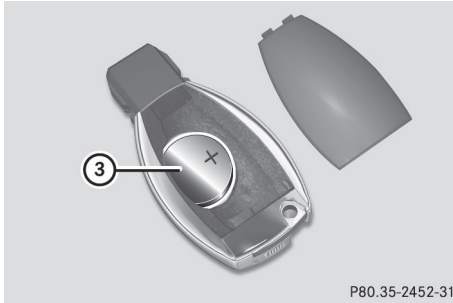



- ▶ Remove battery tray cover ①.



## Opening/closing

- ▶ Repeatedly tap the SmartKey against your palm until battery ③ falls out.
- ▶ Insert the new battery with the positive terminal facing upwards. Use a lint-free cloth to do so.
- ▶ Make sure that the surface of the battery is free from lint, grease and all other forms of contamination.
- ▶ Insert the front tabs of battery tray cover ① and then press to close it.
- ▶ Insert the mechanical key into the SmartKey.
- ▶ Check the function of all SmartKey buttons on the vehicle.

### Problems with the SmartKey

Problem	Possible causes/consequences and ► Solutions
You cannot lock or unlock the vehicle using the SmartKey.	<p>The SmartKey battery is discharged or nearly discharged.</p> <ul style="list-style-type: none"> <li>► Try again to lock/unlock the vehicle using the remote control function of the SmartKey. Point the tip of the SmartKey at the driver's door handle from close range and press the  /  button.</li> </ul> <p>If this does not work:</p> <ul style="list-style-type: none"> <li>► Check the SmartKey battery (▷ page 69) and replace it if necessary (▷ page 69).</li> <li>► Lock (▷ page 74) or unlock (▷ page 74) the vehicle using the mechanical key.</li> </ul> <p>The SmartKey is faulty.</p> <ul style="list-style-type: none"> <li>► Lock (▷ page 74) or unlock (▷ page 74) the vehicle using the mechanical key.</li> <li>► Have the SmartKey checked at a qualified specialist workshop.</li> </ul>
You can no longer lock or unlock the vehicle using KEYLESS-GO.	<p>There is interference from a powerful source of radio waves.</p> <ul style="list-style-type: none"> <li>► Lock/unlock the vehicle using the remote control function of the SmartKey. Point the tip of the SmartKey at the driver's door handle from close range and press the  /  button.</li> </ul> <p>There is a malfunction with KEYLESS-GO.</p> <ul style="list-style-type: none"> <li>► Lock/unlock the vehicle using the remote control function of the SmartKey. Point the tip of the SmartKey at the driver's door handle from close range and press the  /  button.</li> <li>► Have KEYLESS-GO checked at a qualified specialist workshop.</li> </ul> <p>If this does not work:</p> <ul style="list-style-type: none"> <li>► Check the SmartKey battery (▷ page 69) and replace it if necessary (▷ page 69).</li> <li>► Lock (▷ page 74) or unlock (▷ page 74) the vehicle using the mechanical key.</li> </ul>
You have lost a SmartKey.	<ul style="list-style-type: none"> <li>► Have the SmartKey deactivated at a qualified specialist workshop.</li> <li>► Report the loss immediately to the vehicle insurers.</li> <li>► If necessary, have the locks changed as well.</li> </ul>
You have lost the mechanical key.	<ul style="list-style-type: none"> <li>► Report the loss immediately to the vehicle insurers.</li> <li>► If necessary, have the locks changed as well.</li> </ul>

Problem	Possible causes/consequences and ► Solutions
The engine cannot be started using the SmartKey.	<p>The on-board voltage is too low.</p> <ul style="list-style-type: none"> <li>► Switch off non-essential consumers, e.g. seat heating or interior lighting, and try to start the engine again.</li> </ul> <p>If this does not work:</p> <ul style="list-style-type: none"> <li>► Check the starter battery and charge it if necessary (► page 266).</li> </ul> <p>or</p> <ul style="list-style-type: none"> <li>► Jump-start the vehicle (► page 269).</li> </ul> <p>or</p> <ul style="list-style-type: none"> <li>► Consult a qualified specialist workshop.</li> </ul>
The engine cannot be started using the SmartKey.	<p>The steering lock is mechanically blocked.</p> <ul style="list-style-type: none"> <li>► Remove the SmartKey and reinsert it into the ignition lock. While doing this, turn the steering wheel in both directions.</li> </ul>
The engine cannot be started using KEYLESS-GO. The SmartKey is in the vehicle.	<p>A door is open. Therefore, the SmartKey cannot be detected as easily.</p> <ul style="list-style-type: none"> <li>► Close the door and try to start the vehicle again.</li> </ul>
	<p>There is interference from a powerful source of radio waves.</p> <ul style="list-style-type: none"> <li>► Start your vehicle with the SmartKey in the ignition lock.</li> </ul>

## Doors

### Important safety notes

#### WARNING

When leaving the vehicle, always remove the SmartKey from the ignition lock. Always take the SmartKey with you and lock the vehicle. Do not leave children unsupervised in the vehicle, even if they are secured in a child restraint system, and do not give them access to an unlocked vehicle. A child's unsupervised access to a vehicle could result in an accident and/or serious personal injury. They could:

- injure themselves on vehicle parts
- be seriously or fatally injured by extreme heat or cold
- injure themselves or have an accident with vehicle equipment that may still be in operation even after the SmartKey has

been removed from the ignition, such as the seat adjustment, steering wheel adjustment or memory function.

If children open a door, they could cause severe or even fatal injury to other persons; if they get out of the vehicle, they could injure themselves when doing so or be seriously or even fatally injured by any passing traffic.

Do not expose the child restraint system to direct sunlight. The child restraint system's metal parts, for example, could become very hot, and a child could be burned on these parts.

#### WARNING

Do not carry heavy or hard objects in the passenger compartment or trunk unless they are firmly secured in place.

Unsecured or improperly positioned cargo increases a child's risk of injury in the event of

- strong braking maneuvers
- sudden changes of direction
- an accident

### Unlocking and opening doors from the inside

You can open a door from inside the vehicle even if it has been locked.

Only open the door when the traffic situation permits.

If the vehicle was previously locked with the SmartKey or with KEYLESS-GO, opening the vehicle from the inside will activate the anti-theft alarm system. Switch off the alarm (▷ page 64).

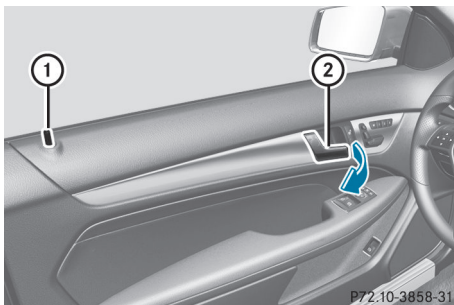

- ▶ Pull door handle ①.

If the door is locked, locking knob ① pops up. The door is unlocked and can be opened.

### Centrally locking and unlocking the vehicle from the inside

You can centrally lock or unlock the vehicle from the inside.

The central locking/unlocking button does not lock or unlock the fuel filler flap.

**i** You cannot unlock the vehicle centrally from the inside if the vehicle has been locked with the SmartKey or KEYLESS-GO.

**i** It is only possible to lock the vehicle centrally if the front-passenger door is closed.

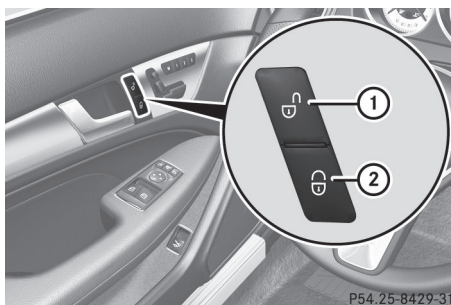

- ▶ **To unlock:** press button ①.

- ▶ **To lock:** press button ②.

If the front-passenger door is closed, the vehicle locks.

You can open a door from inside the vehicle even if it has been locked. Only open the door when the traffic situation permits.

If the vehicle has been locked with the central locking button:

- and the SmartKey is set to its factory setting, the entire vehicle is unlocked if a door is opened from the inside
- and the SmartKey is set to an individual setting, only the door that is opened from inside the vehicle is unlocked.

If the vehicle has been locked centrally with the SmartKey or with KEYLESS-GO, it is not unlocked when the release button for the central locking is used.

### Automatic locking feature

When the ignition is switched on and the wheels of the vehicle are turning at a speed of more than 9 mph (15 km/h), the vehicle locks automatically.

You could therefore be locked out when:

- the vehicle is being pushed.
- the vehicle is being towed.
- the vehicle is being tested on a dynamometer.

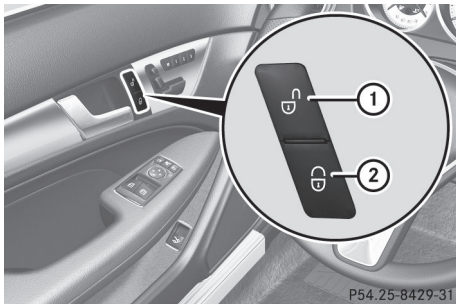

- ▶ **To deactivate:** press and hold button ① for about five seconds until a tone sounds.
- ▶ **To activate:** press and hold button ② for about five seconds until a tone sounds.

**i** If you press one of the two buttons and do not hear a tone, the relevant setting has already been selected.

You can also switch the automatic locking function on and off using the on-board computer (▷ page 179).

#### Unlocking the driver's door (mechanical key)

If the vehicle can no longer be unlocked with the SmartKey, use the mechanical key.

If you use the mechanical key to unlock and open the driver's door, the anti-theft alarm system will be triggered (▷ page 64).

- ▶ Take the mechanical key out of the SmartKey (▷ page 68).
- ▶ Insert the mechanical key into the lock of the driver's door as far as it will go.

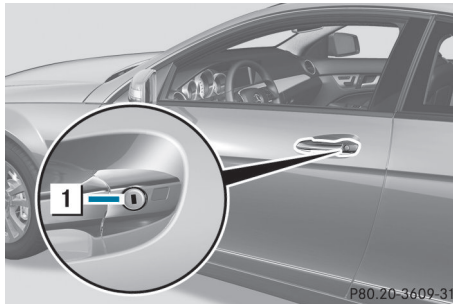

- ▶ Turn the mechanical key counter-clockwise to position 1. The door is unlocked.
- ▶ Turn the mechanical key back and remove it.
- ▶ Insert the mechanical key into the SmartKey.

#### Locking the vehicle (mechanical key)

If the vehicle can no longer be locked with the SmartKey, use the mechanical key.

- ▶ Open the driver's door.
- ▶ Close the front-passenger door and the trunk lid.
- ▶ Press the locking button (▷ page 73).
- ▶ Check whether the locking knob on the front-passenger door is still visible. Press down the locking knob by hand, if necessary.
- ▶ Close the driver's door.
- ▶ Take the mechanical key out of the SmartKey (▷ page 68).
- ▶ Insert the mechanical key into the lock of the driver's door as far as it will go.

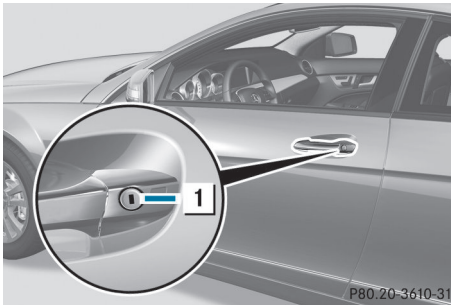

- ▶ Turn the mechanical key clockwise as far as it will go to position **1**.
- ▶ Turn the mechanical key back and remove it.
- ▶ Make sure that the doors and the trunk lid are locked.
- ▶ Insert the mechanical key into the SmartKey.

**i** If you lock the vehicle as described above, the fuel filler flap is not locked. The anti-theft alarm system is not armed.

## Trunk

### Important safety notes

Do not leave the SmartKey in the trunk. You could otherwise lock yourself out.

#### **⚠ WARNING**

When leaving the vehicle, always remove the SmartKey from the ignition lock. Always take the SmartKey with you and lock the vehicle. Do not leave children unsupervised in the vehicle, even if they are secured in a child restraint system, and do not give them access to an unlocked vehicle. A child's unsupervised access to a vehicle could result in an accident and/or serious personal injury. They could:

- injure themselves on vehicle parts
- be seriously or fatally injured by extreme heat or cold
- injure themselves or have an accident with vehicle equipment that may still be in operation even after the SmartKey has

been removed from the ignition, such as the seat adjustment, steering wheel adjustment or memory function.

If children open a door, they could cause severe or even fatal injury to other persons; if they get out of the vehicle, they could injure themselves when doing so or be seriously or even fatally injured by any passing traffic.

Do not expose the child restraint system to direct sunlight. The child restraint system's metal parts, for example, could become very hot, and a child could be burned on these parts.

#### **⚠ WARNING**

Do not carry heavy or hard objects in the passenger compartment or trunk unless they are firmly secured in place.

Unsecured or improperly positioned cargo increases a child's risk of injury in the event of

- strong braking maneuvers
- sudden changes of direction
- an accident

#### **⚠ WARNING**

Make sure the trunk lid is closed when the engine is running and while driving. Among other dangers, deadly carbon monoxide (CO) gases may enter the vehicle interior resulting in unconsciousness and death.

**!** The trunk lid swings upwards when opened. Therefore, make sure that there is sufficient clearance above the trunk lid.

To open the trunk lid completely, a minimum clearance of 5.58 ft (1.70 m) above the ground is necessary.

The trunk lid can be:

- opened and closed manually from outside
- opened automatically from outside
- opened automatically from inside
- locked separately

- unlocked with the mechanical key
- opened with the emergency release button

### Opening and closing manually

#### Opening

- ▶ Press the  button on the SmartKey.

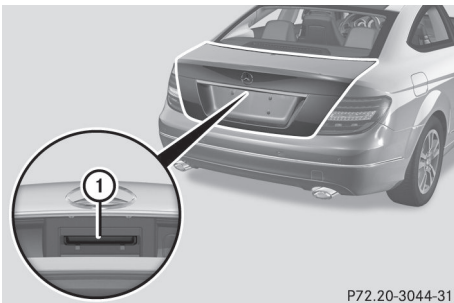

P72.20-3044-31

- ▶ Pull handle ①.
- ▶ Raise the trunk lid.

#### Closing

##### WARNING

To prevent possible personal injury, always keep hands and fingers away from the trunk opening when closing the trunk lid. Be especially careful when small children are around.



P72.20-3045-31

- ▶ Pull the trunk lid down using recess ①.
- ▶ If necessary, lock the vehicle with the  button on the SmartKey

- (▷ page 66) or with KEYLESS-GO (▷ page 67).

- i** If a KEYLESS-GO key is detected in the trunk, the trunk lid cannot be locked and then opens again.

### Opening automatically from the outside

#### Important safety notes

##### WARNING

Make sure the trunk lid is closed when the engine is running and while driving. Among other dangers, deadly carbon monoxide (CO) gases may enter the vehicle interior resulting in unconsciousness and death.

- !** The trunk lid swings upwards when opened. Therefore, make sure that there is sufficient clearance above the trunk lid.

To open the trunk lid completely, a minimum clearance of 5.58 ft (1.70 m) above the ground is necessary.

#### Opening

You can open the trunk lid automatically using the SmartKey or the handle in the trunk lid.

- ▶ Press and hold the  button on the SmartKey until the trunk lid opens.
- or
- ▶ When the trunk is unlocked, pull the trunk lid handle and let it go again immediately.

### Opening automatically from the inside

##### WARNING

Make sure the trunk lid is closed when the engine is running and while driving. Among other dangers, deadly carbon monoxide (CO) gases may enter the vehicle interior resulting in unconsciousness and death.



You can open the trunk lid from the driver's seat when the vehicle is stationary and unlocked.



- ▶ **To open:** pull remote operating switch for trunk lid ① until the trunk lid opens.

### Locking the trunk separately

You can lock the trunk separately. If you then unlock the vehicle centrally, the trunk remains locked and cannot be opened.

- ▶ Close the trunk lid.
- ▶ Take the mechanical key out of the SmartKey (▷ page 68).

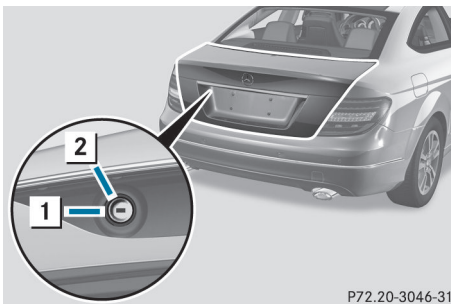

- ▶ Insert the mechanical key into the trunk lid lock as far as the stop.
- ▶ Turn the mechanical key clockwise from position ① to position ②.
- ▶ Remove the mechanical key.
- ▶ Insert the mechanical key into the SmartKey.

### Unlocking the trunk (mechanical key)

- ⚠ The trunk lid swings upwards when opened. Therefore, make sure that there is sufficient clearance above the trunk lid.

If the trunk cannot be unlocked with the SmartKey or KEYLESS-GO, use the mechanical key.

If you use the mechanical key to unlock and open the trunk lid, the anti-theft alarm system will be triggered (▷ page 64).

- ▶ Take the mechanical key out of the SmartKey (▷ page 68).
- ▶ Insert the mechanical key into the trunk lid lock as far as the stop.

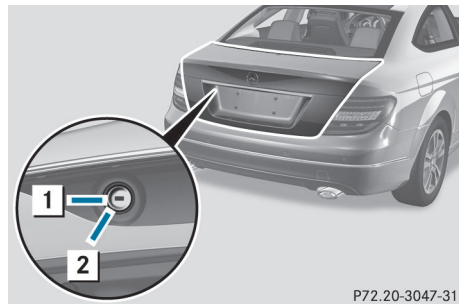

- ▶ Turn the mechanical key counter-clockwise from position ① as far as it will go to position ②. The trunk is unlocked.
- ▶ Turn the mechanical key back to position ① and remove it.
- ▶ Insert the mechanical key into the SmartKey.

### Trunk emergency release

You can open the trunk lid from inside the vehicle with the emergency release button.

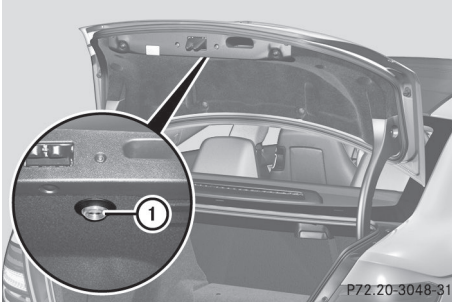

- ▶ Briefly press emergency release button ①.  
The trunk lid unlocks and opens.

The trunk lid can be unlocked and opened with the trunk lid emergency release when the vehicle is stationary or while driving.

Trunk lid emergency release light:

- emergency release button ① flashes for 30 minutes after the trunk lid is opened
- emergency release button ① flashes for 60 minutes after the trunk lid is closed.

The trunk lid emergency release does not open the trunk lid if the battery is disconnected or discharged.

## Side windows

### Important safety notes

#### WARNING

When opening or closing the door windows, make sure that there is no danger of anyone being harmed by the opening/closing procedure.

The front door windows are equipped with automatic operation and the anti-entrapment feature. If in automatic mode a front door window encounters an obstruction that blocks its path, the anti-entrapment feature will stop the door window and open it slightly.

The door windows operate differently when the switch is pulled. See the "Problems with door windows" section for more details.

The closing of the door windows can be immediately halted by releasing the switch or, if the switch was pulled past the resistance point and released, by pressing or pulling the respective switch.

If a door window encounters an obstruction that blocks its path in a circumstance where you are closing the windows by pressing and holding  button on the SmartKey or by pressing and holding the lock button (vehicles with KEYLESS-GO) on an outside door handle, the anti-entrapment feature will not operate.

#### WARNING

Do not keep any part of your body up against the window pane when opening a window. The downward motion of the pane may pull that part of your body down between the window pane and the door frame and trap it there. If there is a risk of entrapment, release the switch and pull it to close the window.

## Opening and closing the side windows

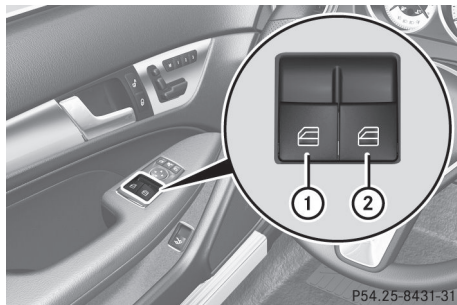

- ① Left
- ② Right

The switches for all side windows are located on the driver's door. There is also a switch for the front-passenger side window on the front-passenger door.

The switches on the driver's door take precedence.

- ▶ Turn the SmartKey to position **1** or **2** in the ignition lock.
- ▶ **To open:** press the corresponding switch.
- ▶ **To close:** pull the corresponding switch.
- i** If you press the switch beyond the point of resistance, an automatic opening/closing process is started in the corresponding direction. You can stop automatic operation by operating the switch again.

- i** You can continue to operate the side windows after you switch off the engine or remove the SmartKey. This function is available for up to five minutes or until the driver's or front-passenger door is opened.



### Convenience opening

You can ventilate the vehicle before you start driving. To do this, the key is used to carry out the following functions simultaneously:

- unlock the vehicle
- open the side windows
- open the panorama roof with power tilt/sliding panel and the roller sunblind
- switch on the seat ventilation for the driver's seat

- i** The convenience opening feature can only be operated using the SmartKey. The SmartKey must be close to the driver's door handle.
- ▶ Point the tip of the SmartKey at the driver's door handle.
- ▶ Press and hold the  button until the side windows and the panorama roof with power tilt/sliding panel are in the desired position.

If the roller sunblind of the panorama roof with power tilt/sliding panel is closed, the roller sunblind is opened first.

- ▶ Press and hold the  button again until the panorama roof with power tilt/sliding panel is in the desired position.
- ▶ **To interrupt convenience opening:** release the  button.

### Convenience closing

#### General notes

When you lock the vehicle, you can simultaneously:



- close the side windows
- close the panorama roof with power tilt/sliding panel

You can then close the roller sunblind.

#### WARNING

When closing the windows and the panorama roof with power tilt/sliding panel, make sure there is no danger of anyone being harmed by the closing procedure.

If potential danger exists, proceed as follows:



- Release button  to stop the closing procedure. To open, press and hold button . To continue the closing procedure after making sure that there is no danger of anyone being harmed by the closing procedure, press and hold button .

Vehicles with KEYLESS-GO:

- Release the sensor surface on the outside door handle to stop the closing procedure.
- Immediately pull on the same outside door handle and hold firmly. The windows and the panorama roof with power tilt/sliding panel will open for as long as the door handle is held but the door not opened.

#### Using the SmartKey

- i** The SmartKey must be close to the driver's door handle.

- ▶ Point the tip of the SmartKey at the driver's door handle.
- ▶ Press and hold the  button until the side windows and the panorama roof with power tilt/sliding panel are fully closed.
- ▶ Make sure that all the side windows and the panorama roof with power tilt/sliding panel are closed.
- ▶ Press and hold the  button again until the roller sunblind of the panorama roof with power tilt/sliding panel closes.
- ▶ **To interrupt convenience closing:** release the  button.

### Using KEYLESS-GO

The KEYLESS-GO key must be outside the vehicle. All the doors must be closed.

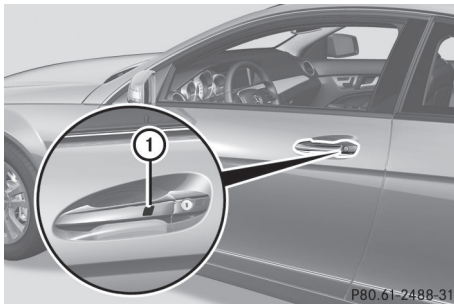

- ▶ Touch recessed sensor surface ① on the door handle until the side windows and the panorama roof with power tilt/sliding panel are fully closed.
- ▶ **i** Make sure you only touch recessed sensor surface ①.
- ▶ Make sure that all the side windows and the panorama roof with power tilt/sliding panel are closed.
- ▶ Touch recessed sensor surface ① on the door handle again until the roller sunblind of the panorama roof with power tilt/sliding panel closes.
- ▶ **To interrupt convenience closing:** release recessed sensor surface ① on the door handle.

### Resetting the side windows

You must reset each side window if a side window can no longer be closed fully.

- ▶ Close all the doors.
- ▶ Turn the SmartKey to position **1** or **2** in the ignition lock.
- ▶ Pull the corresponding switch on the door control panel until the side window is completely closed. (▶ page 78)
- ▶ Hold the switch for an additional second.

If the side window opens again slightly:

- ▶ Immediately pull the corresponding switch on the door control panel until the side window is completely closed (▶ page 78).
- ▶ Hold the switch for an additional second.
- ▶ If the corresponding side window remains closed after the button has been released, the side window has been reset correctly. If this is not the case, repeat the steps above again.

### Problems with the side windows

**Problem: a side window cannot be closed because it is blocked by objects, e.g. leaves in the window guide.**

- ▶ Remove the objects.
- ▶ Close the side window.

**Problem: a side window cannot be closed and you cannot see the cause.**

#### **WARNING**

Closing the side windows with increased force or without the anti-entrapment feature could lead to serious or even fatal injury. Make sure that nobody can become trapped when closing the side windows.

If a side window is obstructed during closing and reopens again slightly:

- ▶ Immediately after the window blocks, pull the corresponding switch again until the side window has closed.  
The side window is closed with increased force.

If a side window is obstructed again during closing and reopens again slightly:

- ▶ Immediately after the window blocks, pull the corresponding switch again until the side window has closed.  
The side window is closed without the anti-entrapment feature.

#### **WARNING**

Pulling and holding the switch to close the door window immediately after it had been blocked two times will cause the door window to close without the anti-entrapment feature for as long as you hold the switch.

## Sliding sunroof

### Important safety notes

In the following section, the term "sliding sunroof" refers to the panorama roof with power tilt/sliding panel.

#### **WARNING**

When opening or closing the sliding sunroof, make sure that there is no danger of anyone being harmed by the opening/closing procedure.

The sliding sunroof is equipped with automatic operation and the anti-entrapment feature. If the movement of the sliding sunroof is blocked during the closing procedure, the sliding sunroof will stop and open slightly.

The sliding sunroof operates differently when the sliding sunroof switch is pressed and held. See the "Problems with the sliding sunroof" section for more details.

The opening/closing procedure of the sliding sunroof can be immediately halted by

releasing the sliding sunroof switch or, if the sliding sunroof switch was moved past the resistance point and released, by moving the sliding sunroof switch in any direction.

#### **WARNING**

The sliding sunroof is made out of glass. In the event of an accident, the glass may shatter. This may result in an opening in the roof.

In a vehicle rollover, occupants not wearing their seat belts or not wearing them properly may be thrown out of the opening. Such an opening also presents a potential for injury for occupants wearing their seat belts properly, as entire body parts or portions of them may protrude from the passenger compartment.

- ❗ Only open the sliding sunroof if it is free of snow and ice. Otherwise, malfunctions may occur.  
Do not allow anything to protrude from the sliding sunroof. Otherwise, the seals could be damaged.
- ❗ The weather can change abruptly. It could start to rain or snow. Make sure that the sliding sunroof is closed when you leave the vehicle. The vehicle electronics can be damaged if water enters the vehicle interior.

- i Resonance noises can occur in addition to the usual airflow noises when the sliding sunroof is open. They are caused by minor pressure fluctuations in the vehicle interior. Change the position of the sliding sunroof or open a side window slightly to reduce or eliminate these noises.

### Operating the panorama roof with power tilt/sliding panel

#### Opening and closing

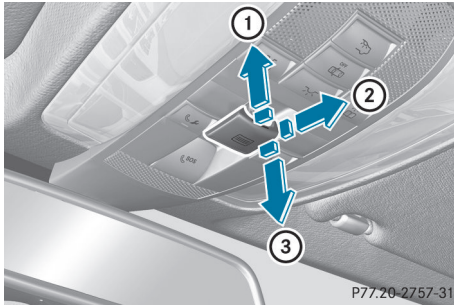

Overhead control panel

- ① To raise
- ② To open
- ③ To close/lower

The panorama roof with power tilt/sliding panel can only be operated when the roller sunblind is open.

- ▶ Turn the SmartKey to position **1** or **2** in the ignition lock.
- ▶ Push or pull the  switch in the corresponding direction.

**i** If you press the  switch beyond the point of resistance, an automatic opening/closing process is started in the corresponding direction. You can stop automatic operation by operating the switch again.

### Operating the roller sunblind for the panorama roof with power tilt/sliding panel

#### General notes

The roller sunblind shields the vehicle interior from sunlight. The roller sunblind can only be opened and closed when the panorama roof with power tilt/sliding panel is closed.

#### WARNING

When opening or closing the roller sunblind, make sure that no one can be injured.

The roller sunblind has automatic operation and an anti-entrapment feature. If the roller sunblind is blocked during the closing procedure, the anti-entrapment feature stops the roller sunblind and it opens again slightly. The manual opening and closing of the roller sunblind can be terminated immediately by releasing the button. In automatic operation, press the button briefly in any direction to stop the roller sunblind.

#### Opening/closing

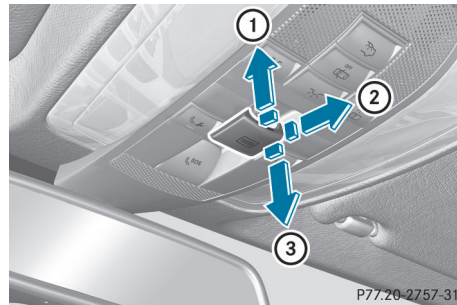

Overhead control panel

- ① To open
- ② To open
- ③ To close





- ▶ Turn the SmartKey to position **1** or **2** in the ignition lock.
- ▶ Press or pull the  switch in the corresponding direction.

**i** If you press the  switch beyond the point of resistance, an automatic opening/closing process is started in the corresponding direction. You can stop automatic operation by operating the switch again.



### Resetting the panorama roof with power tilt/sliding panel and the roller sunblind

Reset the panorama roof with power tilt/sliding panel and the roller sunblind if the panorama roof with power tilt/sliding panel or the roller sunblind does not move smoothly.

- ▶ Turn the SmartKey to position **1** or **2** in the ignition lock.
- ▶ Pull the  switch repeatedly to the point of resistance in the direction of arrow ③ until the panorama roof with power tilt/sliding panel is fully closed.
- ▶ Keep the  switch pulled for an additional second.
- ▶ Pull the  switch repeatedly to the point of resistance in the direction of arrow ③ until the roller sunblind is fully closed.
- ▶ Keep the  switch pulled for an additional second.
- ▶ Make sure that the panorama roof with power tilt/sliding panel (▷ page 82) and the roller sunblind (▷ page 82) can be fully opened again.
- ▶ If this is not the case, repeat the steps above again.

**!** If the panorama roof with power tilt/sliding panel and the roller sunblind cannot be fully opened or closed after resetting, contact a qualified specialist workshop.

### Problems with the sliding sunroof

In the following section, the term "sliding sunroof" refers to the panorama roof with power tilt/sliding panel.

**Problem: the sunroof cannot be closed and you cannot see the cause.**

#### **WARNING**

You could be severely or even fatally injured when closing the sliding sunroof with increased closing force or if the anti-

entrapment feature is deactivated. Make sure that nobody can become trapped when closing the sliding sunroof.

If the sliding sunroof is obstructed during closing and reopens again slightly:

- ▶ Immediately after the sliding sunroof blocks, pull the  switch in the overhead control panel down to the point of resistance and hold it until the sliding sunroof is closed.  
The sliding sunroof is closed with increased force.

If the sliding sunroof is obstructed again during closing and reopens again slightly:

- ▶ Immediately after the sliding sunroof blocks, pull the  switch in the overhead control panel down to the point of resistance and hold it until the sliding sunroof is closed.  
The sliding sunroof is closed without the anti-entrapment feature.

#### **WARNING**

Pressing and holding the sliding sunroof switch to close the sliding sunroof immediately after it had been blocked two times will cause the sliding sunroof to close without the anti-entrapment feature for as long as you hold the switch.

- !** If the sliding sunroof still cannot be opened or closed as a result of a malfunction, contact a qualified specialist workshop.





Useful information .....	86
Correcting the driver's seat position .....	86
Seats .....	87
Steering wheel .....	91
Mirrors .....	93
Memory function .....	95

## Useful information

- i** This Operator's Manual describes all models and all standard and optional equipment of your vehicle available at the time of publication of the Operator's Manual. Country-specific differences are possible. Please note that your vehicle may not be equipped with all features described. This also applies to safety-related systems and functions.
- i** Please read the information on qualified specialist workshops (▷ page 23).

## Correcting the driver's seat position



Observe the safety guidelines on seat adjustment (▷ page 87).

- ▶ Check whether you have adjusted seat ③ properly.

Manual and electrical seat adjustment (▷ page 88)

Electrical seat adjustment (▷ page 88)

When adjusting the seat, make sure:

- you are as far away from the driver's air bag as possible.
- you are sitting in a normal upright position.

- you can fasten the seat belt properly.
- you have moved the backrest to an almost vertical position.
- you have set the seat cushion angle so that your thighs are gently supported.
- you can depress the pedals properly.

- ▶ Check whether the head restraint is adjusted properly (▷ page 89).

When doing so, make sure that you have adjusted the head restraint so that the back of your head is supported at eye level by the center of the head restraint.

Observe the safety guidelines on steering wheel adjustment (▷ page 91).

- ▶ Check whether steering wheel ① is adjusted properly.

Adjusting the steering wheel manually (▷ page 91)

Adjusting the steering wheel electrically (▷ page 92)

When adjusting the steering wheel, make sure:

- you can hold the steering wheel with your arms slightly bent.
- you can move your legs freely.
- you can see all the displays in the instrument cluster clearly.

Observe the safety guidelines for seat belts (▷ page 50).

- ▶ Check whether you have fastened seat belt ② properly (▷ page 51).

The seat belt should:

- fit snugly across your body
- be routed across the middle of your shoulder
- be routed in your pelvic area across the hip joints

- ▶ Before starting off, adjust the rear-view mirror and the exterior mirrors

(▷ page 93) in such a way that you have a good view of road and traffic conditions.

- ▶ **Vehicles with a memory function:** save the seat, steering wheel and exterior mirror settings (▷ page 95).

## Seats

### Important safety notes

#### WARNING

In order to avoid possible loss of vehicle control, all seat, head restraint, steering wheel and rear view mirror adjustments, as well as fastening of seat belts, must be done before setting the vehicle in motion.

#### WARNING

Do not adjust the driver's seat while driving. Adjusting the seat while driving could cause the driver to lose control of the vehicle.

Never travel in a moving vehicle with the seat backrest in an excessively reclined position as this can be dangerous. You could slide under the seat belt in a collision. If you slide under it, the seat belt would apply force at the abdomen or neck. This could cause serious or fatal injuries. The seat backrest and seat belts provide the best restraint when the wearer is in a position that is as upright as possible and seat belts are properly positioned on the body.

#### WARNING

Your seat belt must be adjusted so that you can correctly fasten your seat belt.

Observe the following points:

- adjust the seat backrest until your arms are slightly angled when holding the steering wheel.
- adjust the seat to a comfortable seating position that still allows you to reach the accelerator/brake pedal safely. The position should be as far back as possible

with the driver still able to operate the controls properly.

- adjust the head restraint so that it is as close to the head as possible and the center of the head restraint supports the back of the head at eye level.
- never place hands under the seat or near any moving parts while a seat is being adjusted.

Failure to do so could result in an accident and/or serious personal injury.

#### WARNING

The electrically adjustable seats can be operated at any time. Therefore, do not leave children unattended in the vehicle, or with access to an unlocked vehicle. A child's unsupervised access to a vehicle could result in an accident and/or serious personal injury.

#### WARNING

According to accident statistics, children are safer when properly restrained on the rear seats than on the front-passenger seat. Thus, we strongly recommend that children be placed in the rear seat whenever possible. Regardless of seating position, children 12 years old and under must be seated and properly secured in an appropriately sized child restraint system or booster seat recommended for the size and weight of the child. For additional information, see the "Children in the vehicle" section.

A child's risk of serious or fatal injuries is significantly increased if the child restraints are not properly secured in the vehicle and/or the child is not properly secured in the child restraint.

#### WARNING

For your protection, drive only with properly positioned head restraints.

Adjust the head restraint so that it is as close to the head as possible and the center of the head restraint supports the back of the head at eye level. This will reduce the potential for

injury to the head and neck in the event of an accident or similar situation.

Do not drive the vehicle without the seat head restraints. Head restraints are intended to help reduce injuries during an accident.

**!** To avoid damage to the seats and the seat heating, observe the following information:

- keep liquids from spilling on the seats. If liquid is spilled on the seats, dry them as soon as possible.
- if the seat covers are damp or wet, do not switch on the seat heating. The seat heating should also not be used to dry the seats.
- clean the seat covers as recommended; see the "Interior care" section.
- do not transport heavy loads on the seats. Do not place sharp objects on the seat cushions, e.g. knives, nails or tools. The seats should only be occupied by passengers, if possible.
- when the seat heating is in operation, do not cover the seats with insulating materials, e.g. blankets, coats, bags, seat covers, child seats or booster seats.

**!** Make sure that there are no objects in the footwell or behind the seats when resetting the seats. There is a risk that the seats and/or the objects could be damaged.

**i** Vehicles without the through-loading feature: the head restraints cannot be removed from the rear compartment seats. For more information, contact a qualified specialist workshop.

**i** Other topics:

- Rear bench seat through-loading feature (▷ page 225)

### Adjusting the seats manually and electrically

You can only adjust the front-passenger seat manually and electrically.

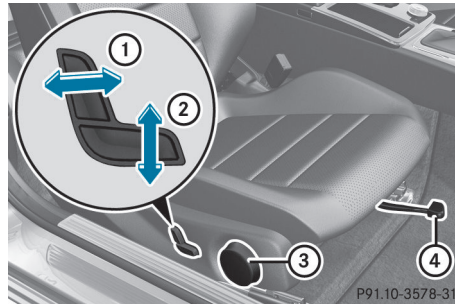

- ① Backrest angle
- ② Seat height
- ③ Seat cushion angle
- ④ Seat fore-and-aft adjustment

**i** Adjust the seat cushion angle so that your thighs are lightly supported.

### Seat fore-and-aft adjustment

- ▶ Lift handle ④ and slide the seat forwards or backwards.
- ▶ Release lever ④ again. Make sure that you hear the seat engage in position.

### Seat cushion angle

- ▶ Turn handwheel ③ in the desired direction.

### Adjusting the seats electrically

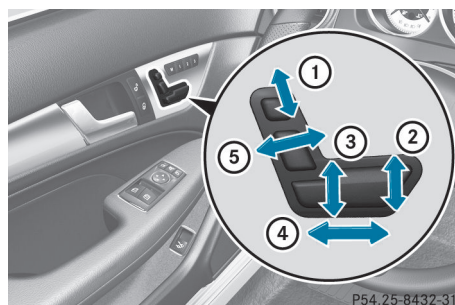

- ① Head restraint height
- ② Seat cushion angle
- ③ Seat height

- ④ Seat fore-and-aft adjustment
- ⑤ Backrest angle

### Adjusting the head restraints

#### Adjusting the head restraint height electrically

- ▶ **To adjust the head restraint height:** slide the switch for head restraint adjustment (▷ page 88) up or down in the direction of the arrow.

### Folding the front-seat backrests forward/back

#### Important safety notes

##### ⚠ WARNING

The seat belts can only provide protection if the seat backrest is locked in the upright position. The seat backrest must therefore be locked in the upright position during the journey. Do not drive the vehicle if the seat backrest is not locked in the upright position. If the

**Lock Seat Backrest Front Right**

or

**Lock Seat Backrest Front Left**

warning message is displayed in the multifunction display, then the corresponding seat backrest is not locked. Carefully slow down and drive with caution to an area which is a safe distance from the road. Always ensure that there is sufficient space behind the seat backrest and fold the seat backrest back fully until it engages in the locking mechanism.

The warning message is no longer displayed once the seat backrest engages in the locking mechanism. If both seat backrests are locked and the warning message continues to be displayed, have the system checked by a Mercedes-Benz Center without delay.

##### ⚠ WARNING

Always ensure that no-one can become trapped or injured by the movement of the seat. In a potentially hazardous situation, the procedure can be interrupted by moving the seat adjustment switch in the door control panel or by operating one of the position buttons of the Memory function.

#### Folding the backrest forwards

The seat moves forwards if you have folded the backrest forwards and the seat is in the rear half of the range. This makes it easier for passengers to get into and out of the rear compartment. The head restraint is lowered simultaneously.



- ▶ Pull seat release handle ① forwards and fold the backrest forwards as far as it will go. The seat automatically moves to the foremost position and the head restraint is lowered.

#### Folding back the backrest

- ▶ Swing back the seat backrest. The seat moves automatically to the stored position.

#### Adjusting the four-way lumbar support

You can adjust the contour of the front seat backrests individually to provide optimum support for your back.

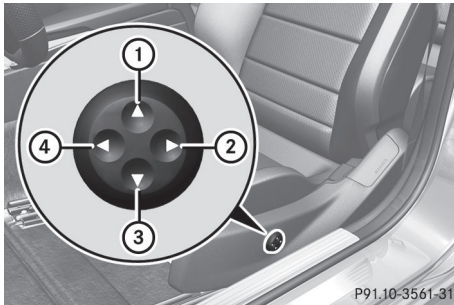

- ① To raise the backrest contour
- ② To soften the backrest contour
- ③ To lower the backrest contour
- ④ To harden the backrest contour

### Switching the seat heating on/off

#### Switching on/off

##### WARNING

Repeatedly setting the seat heating to level **3** may result in excessive seat temperatures. The health of passengers that have limited temperature sensitivity or a limited ability to react to excessively high temperatures may be affected or they may even suffer burn-like injuries. Therefore, do not use seat heating level **3** repeatedly.

The three red indicator lamps in the button indicate the heating level you have selected.

-  If the battery voltage is too low, the seat heating may switch off.



Driver's and front-passenger seat

The system automatically switches down from level **3** to level **2** after approximately eight minutes.

The system automatically switches down from level **2** to level **1** after approximately ten minutes.

The system automatically switches off approximately 20 minutes after it is set to level **1**.

- ▶ Make sure that the SmartKey is in position **1** or **2** in the ignition lock.
- ▶ **To switch on:** press button ① repeatedly until the desired heating level is set.
- ▶ **To switch off:** press button ① repeatedly until all the indicator lamps go out.

### Problems with the seat heating

The seat heating has switched off prematurely or cannot be switched on. The vehicle's electrical system voltage is too low because too many electrical consumers are switched on.

- ▶ Switch off electrical consumers that you do not need, such as the rear window defroster or interior lighting.

### Switching the seat ventilation on/off

#### Switching on/off

The three blue indicator lamps in the buttons indicate the ventilation level you have selected.

-  If the battery voltage is too low, the seat ventilation may switch off.





P54.25-8543-31

- ▶ Make sure that the SmartKey is in position **2** in the ignition lock.
- ▶ **To switch on:** press button ① repeatedly until the desired ventilation level is set.
- i** You can open the front side windows and the sliding sunroof using the "Convenience opening" feature (▶ page 79). The seat ventilation of the driver's seat automatically switches to the highest level.
- ▶ **To switch off:** press button ① repeatedly until all the indicator lamps go out.

### Problems with the seat ventilation

The seat ventilation has switched off prematurely or cannot be switched on. The vehicle's electrical system voltage is too low because too many electrical consumers are switched on.

- ▶ Switch off electrical consumers which you do not need, such as the rear window defroster or interior lighting.

## Steering wheel

### Important safety notes

#### **WARNING**

Do not adjust the steering wheel while driving. Adjusting the steering wheel while driving, or driving without the steering wheel adjustment feature locked could cause the driver to lose control of the vehicle.

The electrical steering wheel adjustment feature can be operated at any time. Therefore, do not leave children unattended in the vehicle, or with access to an unlocked vehicle. A child's unsupervised access to a vehicle could result in an accident and/or serious personal injury.

### Adjusting the steering wheel manually

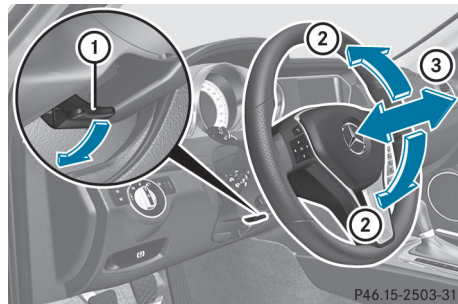

P46.15-2503-31

- ① Release lever
  - ② To adjust the steering wheel height
  - ③ To adjust the steering wheel position (fore-and-aft adjustment)
- ▶ Push release lever ① down completely. The steering column is unlocked.
  - ▶ Adjust the steering wheel to the desired position.
  - ▶ Push release lever ① up completely. The steering column is locked.
  - ▶ Check if the steering column is locked. When doing so, try to push the steering wheel up or down or try to move it in the fore-and-aft direction.

### Adjusting the steering wheel electrically

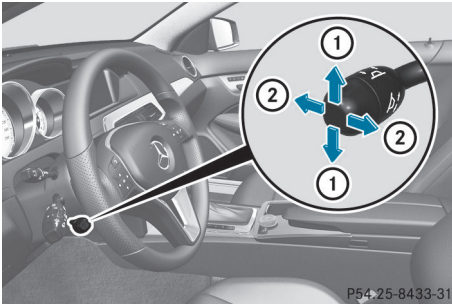

- ① To adjust the steering wheel height
- ② To adjust the steering wheel position (fore-and-aft adjustment)

#### **i** Other topics:

- EASY-ENTRY/EXIT feature (▷ page 92)
- storing settings (▷ page 95)

### EASY-ENTRY/EXIT feature

#### Important safety notes

The EASY-ENTRY/EXIT feature makes getting in and out of your vehicle easier.

You can activate and deactivate the EASY-ENTRY/EXIT feature in the on-board computer (▷ page 180).

#### **⚠ WARNING**

Let the system complete the adjustment procedure before setting the vehicle in motion. All steering wheel adjustment must be completed before setting the vehicle in motion. Driving off with the steering wheel still adjusting could cause the driver to lose control of the vehicle.

### Position of the steering wheel when the EASY-ENTRY/EXIT feature is active

The steering wheel swings upwards when you:

- remove the SmartKey from the ignition lock
- open the driver's door and KEYLESS-GO is in position **1**
- open the driver's door and the SmartKey is in position **0** or **1** in the ignition lock

**i** The steering wheel only moves upwards if it has not already reached the upper end stop.

### Position of the steering wheel for driving

The steering wheel is moved to the last selected position when:

- the driver's door is closed.
- you insert the SmartKey into the ignition lock.
- or
- you press the Start/Stop button once on vehicles with KEYLESS-GO.

When you close the driver's door with the ignition switched on, the steering wheel is also automatically moved to the previously set position.

The last position of the steering wheel is stored after each manual setting or when you store the setting with the memory function (▷ page 95).

## Mirrors

### Rear-view mirror

#### Rear-view mirror (manual anti-glare)



P68.40-2184-31

- ▶ **anti-glare mode:** flick anti-glare switch ① forwards or back.

### Exterior mirrors

#### Adjusting the exterior mirrors

#### WARNING

Exercise care when using the passenger-side exterior rear view mirror. The mirror surface is convex (outwardly curved surface for a wider field of view). Objects in mirror are closer than they appear. Check your interior rear view mirror and glance over your shoulder before changing lanes.

The exterior mirrors are automatically heated if the rear window defroster is switched on and the outside temperature is low.

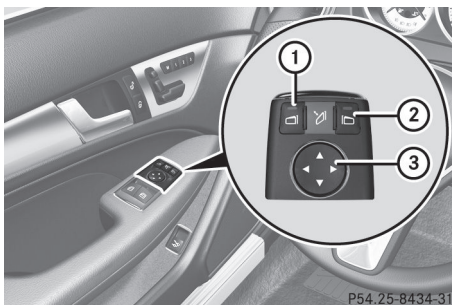

P54.25-8434-31

- ▶ Make sure that the SmartKey is in position **1** or **2** in the ignition lock.
- ▶ Press button ① for the left-hand exterior mirror or button ② for the right-hand exterior mirror.  
The indicator lamp in the corresponding button lights up in red.  
The indicator lamp goes out again after some time. You can adjust the selected mirror using adjustment button ③ as long as the indicator lamp is lit.
- ▶ Press adjustment button ③ up, down, or to the left or right until you have adjusted the exterior mirror to the correct position. You should have a good overview of traffic conditions.

#### Folding the exterior mirrors in or out electrically

This function is only available in vehicles for Canada.

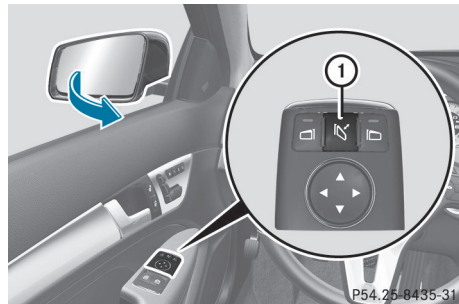

P54.25-8435-31

- ▶ Make sure that the SmartKey is in position **1** or **2** in the ignition lock.
- ▶ Briefly press button ①.  
Both exterior mirrors fold in or out.
- i** Make sure that the exterior mirrors are always folded out fully while driving. They could otherwise vibrate.
- i** If you are driving faster than 9 mph (15 km/h), you can no longer fold in the exterior mirrors.

### Setting the exterior mirrors

This function is only available in vehicles for Canada.

If the battery has been disconnected or completely discharged, the exterior mirrors must be reset. The exterior mirrors will otherwise not fold in when you select the "Fold in mirrors when locking" function in the on-board computer (▷ page 181).

- ▶ Make sure that the SmartKey is in position **1** in the ignition lock.
- ▶ Briefly press button .

### Folding the exterior mirrors in or out automatically

This function is only available in vehicles for Canada.

If the "Fold in mirrors when locking" function is activated in the on-board computer (▷ page 181):

- the exterior mirrors fold in automatically as soon as you lock the vehicle from the outside.
- the exterior mirrors fold out again automatically as soon as you unlock the vehicle and then open the driver's or front-passenger door.

-  If the exterior mirrors have been folded in manually, they do not fold out.

### Exterior mirror out of position

If an exterior mirror has been pushed out of position, proceed as follows:

- ▶ **Vehicles without electrically folding exterior mirrors:** move the exterior mirror into the correct position manually.
- ▶ **Vehicles with electronically folding mirrors<sup>3</sup>:** press the mirror-folding button

(▷ page 93) repeatedly until you hear the mirror engage in position.

The mirror housing is engaged again and you can adjust the exterior mirrors as usual (▷ page 93).

### Automatic anti-glare mirrors

#### WARNING

If incident light from headlamps is prevented from striking the sensor in the rear-view mirror, for instance, by luggage piled too high in the vehicle, the mirror's automatic anti-glare function will not operate.

Incident light could then blind you. This may distract you from the traffic conditions and, as a result, you may cause an accident.

The rear-view mirror and the exterior mirror on the driver's side automatically go into anti-glare mode if the ignition is switched on and incident light from headlamps strikes the sensor in the rear-view mirror.

The mirrors do not go into anti-glare mode if reverse gear is engaged.

### Parking position for the exterior mirror on the front-passenger side

#### Setting and storing the parking position

You can position the front-passenger side exterior mirror in such a way that you can see the rear wheel on that side as soon as you engage reverse gear. You can store this position.

<sup>3</sup> Canada only.

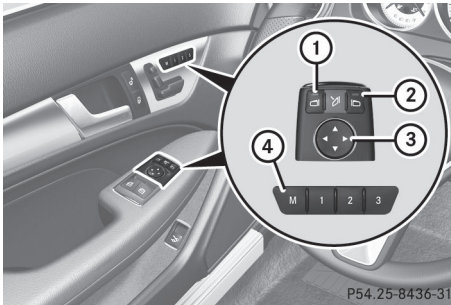

- ▶ Make sure that the vehicle is stationary and that the SmartKey is in position **2** in the ignition lock.
  - ▶ Press button **②** for the exterior mirror on the front-passenger side.
  - ▶ Engage reverse gear.  
The exterior mirror on the front-passenger side moves to the preset parking position.
  - ▶ Use adjustment button **③** to adjust the exterior mirror. You should see the rear wheel and the curb in the exterior mirror. The parking position is stored.
- i** If you shift the transmission to another position, the exterior mirror on the front-passenger side returns to the driving position.
- i** You can also store the parking position using the **M** memory button **④**.
- ▶ Make sure that the SmartKey is in position **2** in the ignition lock.
  - ▶ With the exterior mirror on the front-passenger side activated, use adjustment button **③** to adjust the exterior mirror. You should see the rear wheel and the curb in the exterior mirror on the front-passenger side.
  - ▶ Press the **M** memory button **④** and one of the arrows on adjustment button **③** within three seconds.  
The parking position is stored if the exterior mirror does not move.

If the mirror moves out of position, repeat the steps.

### Calling up a stored parking position setting

- ▶ Turn the SmartKey to position **2** in the ignition lock.
- ▶ Adjust the exterior mirror on the front-passenger side with the corresponding button (▷ page 93).
- ▶ Engage reverse gear.  
The exterior mirror on the front-passenger side moves to the stored parking position.

The exterior mirror on the front-passenger side moves back to its original position:

- as soon as you exceed a speed of 9 mph (15 km/h)
- about ten seconds after you have disengaged reverse gear
- if you press button **①** for the exterior mirror on the driver's side

### Memory function

#### Storing settings

#### **⚠ WARNING**

Do not activate the memory function while driving. Activating the memory function while driving could cause the driver to lose control of the vehicle.

With the memory function, you can store up to three different settings, e.g. for three different people.

The following settings are stored as a single memory preset:

- position of the seat, backrest and head restraint
- driver's side: steering wheel position
- driver's side: position of the exterior mirrors on the driver's and front-passenger sides

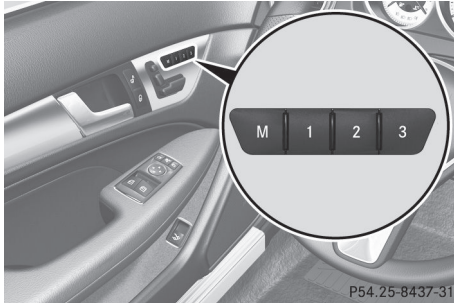

- ▶ Adjust the seat (▷ page 88).
- ▶ On the driver's side, adjust the steering wheel (▷ page 92) and the exterior mirrors (▷ page 93).
- ▶ Briefly press the **M** memory button and then press storage position button **1**, **2** or **3** within three seconds.  
The settings are stored in the selected preset position. A tone sounds when the settings have been completed.

#### Calling up a stored setting

- ▶ Press and hold the relevant storage position button **1**, **2** or **3** until the seat, steering wheel and exterior mirrors are in the stored position.
- i** The setting procedure is interrupted as soon as you release the storage position button.

Useful information ..... 98  
Exterior lighting ..... 98  
Interior lighting ..... 104  
Replacing bulbs ..... 104  
Windshield wipers ..... 108





### Useful information

- i** This Operator's Manual describes all models and all standard and optional equipment of your vehicle available at the time of publication of the Operator's Manual. Country-specific differences are possible. Please note that your vehicle may not be equipped with all features described. This also applies to safety-related systems and functions.
- i** Please read the information on qualified specialist workshops (▷ page 23).

### Exterior lighting

#### Important safety notes

For reasons of safety, Mercedes-Benz recommends that you drive with the lights switched on even during the daytime. In some countries, operation of the headlamps varies due to legal requirements and self-imposed obligations.

#### Information about driving abroad

**To convert to symmetrical low beam when driving abroad:** switch the headlamps to symmetrical low beam in countries in which traffic drives on the opposite side of the road from the country where the vehicle is registered. This prevents glare to oncoming traffic. Symmetrical lights do not illuminate as large an area of the edge of the road.

Have the headlamps converted at a qualified specialist workshop as close to the border as possible before driving in these countries.

**To convert to asymmetrical low beam after returning:** have the headlamps converted back to asymmetrical low beam at a qualified specialist workshop as soon as possible after crossing the border and returning to the original country.

### Light switch

#### Operation

Depending on the date of manufacture of your vehicle, the **A** or **AUTO** symbol for the automatic headlamp mode/daytime running lamps is located on the light switch.

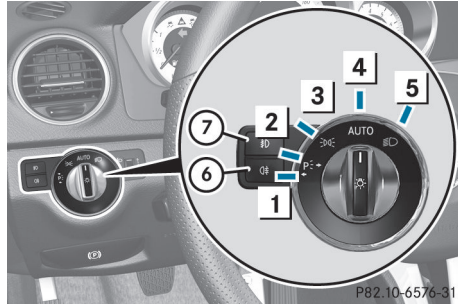

Illustration: light switch with the **AUTO** symbol for the automatic headlamp mode/daytime running lamps

- 1** Left-hand standing lamps
- 2** Right-hand standing lamps
- 3** Parking lamps, license plate and instrument cluster lighting
- 4** **AUTO** Automatic headlamp mode/daytime running lamps
- 5** Low-beam/high-beam headlamps
- 6** Rear fog lamp
- 7** Front fog lamps<sup>4</sup>

<sup>4</sup> Only vehicles with front fog lamps have the fog lamps function.

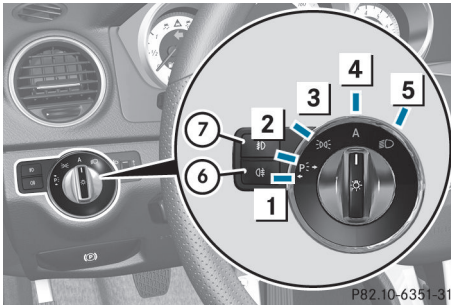

Illustration: light switch with the **A** symbol for the automatic headlamp mode/daytime running lamps

- 1 **P** ← Left-hand standing lamps
- 2 **P** → Right-hand standing lamps
- 3 Parking lamps, license plate and instrument cluster lighting
- 4 **A** Automatic headlamp mode/daytime running lamps
- 5 Low-beam/high-beam headlamps
- 6 Rear fog lamp
- 7 Front fog lamps<sup>4</sup>

The turn signals, high-beam headlamps and the high-beam flasher are operated using the combination switch (▷ page 101).

**!** Switch off the parking lamps and standing lamps when you leave the vehicle. This prevents the battery from discharging.

The exterior lighting (except the parking/standing lamps) switches off automatically if you:

- remove the SmartKey from the ignition lock
- open the driver's door with the SmartKey in position **0**

If you hear a warning tone when you leave the vehicle, the lights may still be switched on.

- ▶ Turn the light switch to **A** or **AUTO**.

### Low-beam headlamps

- ▶ **To switch on the low-beam headlamps:** turn the SmartKey in the ignition lock to position **2** or start the engine.
- ▶ Turn the light switch to . The indicator lamp in the instrument cluster lights up.

### Daytime running lamps

#### Daytime running lamps in Canada

The daytime running lamps function is required by law in Canada. It cannot therefore be deactivated.

- ▶ Turn the light switch to **A** or **AUTO**.  
With the engine running: depending on the ambient light, the daytime running lamps or the low-beam headlamps are switched on. When the low-beam headlamps are switched on, the indicator lamp in the instrument cluster lights up.

When the engine is running and the vehicle is stationary: if you move the selector lever from a drive position to **P** (vehicles with automatic transmission) or if the parking brake is applied, the low-beam headlamps go out after three minutes.

When the engine is running, the vehicle is stationary and in high ambient light brightness: if you turn the light switch to , the daytime running lamps and the parking lamps are switched on.

If the engine is running and you turn the light switch to , the manual settings take precedence over the daytime running lamps.

#### Daytime running lamps in the USA

In the USA, the daytime running lamps are deactivated upon delivery from the factory.

- ▶ **To activate the daytime running lamps (vehicles with a luxury multifunction steering wheel):** you can activate the

<sup>4</sup> Only vehicles with front fog lamps have the fog lamps function.

daytime running lamps function using the on-board computer (▷ page 178).



- ▶ Turn the light switch to **A** or **AUTO**.

With the engine running: depending on the ambient light, the daytime running lamps or the low-beam headlamps are switched on.

When the low-beam headlamps are switched on, the  indicator lamp in the instrument cluster lights up.

It is only possible to activate the high-beam headlamps if the brightness of the ambient light is at a low level.

However, the high-beam flasher can always be used.

If the engine is running and you turn the light switch to  or , the manual settings take precedence over the daytime running lamps.

### Automatic headlamp mode

- ▶ **To switch on automatic headlamp mode:** turn the light switch to **A** or **AUTO**.

SmartKey in position **1** in the ignition lock: the parking lamps are switched on or off automatically depending on the brightness of the ambient light.

With the engine running: depending on the brightness of the ambient light, the daytime running lamps<sup>5</sup> or the low-beam headlamps are switched on or off automatically.

When the low-beam headlamps are switched on, the  indicator lamp in the instrument cluster lights up.

#### **WARNING**

If the light switch is set to **A** or **AUTO**, the low-beam headlamps will not come on automatically if it is foggy. This could endanger you and others. Therefore, turn the light switch to  in fog.





The automatic headlamp feature is only an aid. The driver is responsible for the vehicle's lighting at all times.

### Front fog lamps

Only vehicles with front fog lamps have the fog lamps function.

#### **WARNING**





If you suspect that driving conditions will be foggy, turn the light switch to  before you start your journey. Your vehicle may otherwise not be visible and you could endanger yourself and others.

- ▶ **To switch on the front fog lamps:** turn the SmartKey in the ignition lock to position **2** or start the engine.
- ▶ Turn the light switch to  or **A** or **AUTO**.
- ▶ Press the  button.  
The green  indicator lamp in the instrument cluster lights up.
- ▶ **To switch off the front fog lamps:** press the  button.  
The green  indicator lamp in the instrument cluster goes out.

### Rear fog lamp

- ▶ **To switch on the rear fog lamp:** turn the SmartKey in the ignition lock to position **2** or start the engine.
- ▶ Turn the light switch to  or **A** or **AUTO**.  
If the light switch is set to **A** or **AUTO**, the rear fog lamp only lights up if the low-beam headlamps are on.

<sup>5</sup> Only if daytime running lamps have been activated via the on-board computer.

- ▶ Press the  button.  
The yellow  indicator lamp in the instrument cluster lights up.
- ▶ **To switch off the rear fog lamp:** press the  button.  
The yellow  indicator lamp in the instrument cluster goes out.

### Headlamp cleaning system

If the "Wipe with washer fluid" function is operated five times (▶ page 108) while the lights are on and the engine is running, the headlamps are cleaned automatically. When you switch off the ignition, the automatic headlamp cleaning system is reset and counting is resumed from 0.

### Combination switch

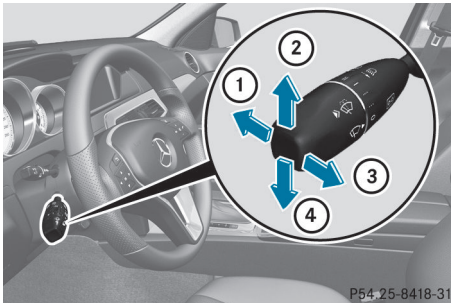

#### Turn signals



- ① High-beam headlamps
- ② Right turn signal
- ③ High-beam flasher
- ④ Left turn signal

- ▶ **To indicate briefly:** press the combination switch briefly to the pressure point in the direction of arrow ② or ④.  
The corresponding turn signal flashes three times.
- ▶ **To indicate:** press the combination switch beyond the pressure point in the direction of arrow ② or ④.

### High-beam headlamps

- ▶ **To switch on the high-beam headlamps:** turn the SmartKey in the ignition lock to position 2 or start the engine.
- ▶ Turn the light switch to  or **A** or **AUTO**.
- ▶ Press the combination switch beyond the pressure point in the direction of arrow ①.  
In the **A** or **AUTO** position, the high-beam headlamps are only switched on when it is dark and the engine is running.  
The  indicator lamp in the instrument cluster lights up when the high-beam headlamps are switched on.
- ▶ **To switch off the high-beam headlamps:** move the combination switch back to its normal position.  
The  indicator lamp in the instrument cluster goes out.

### High-beam flasher

- ▶ **To switch on:** turn the SmartKey in the ignition lock to position 1 or 2 or start the engine.
- ▶ Pull the combination switch in the direction of arrow ③.

### Hazard warning lamps



The hazard warning lamps automatically switch on if:

- an air bag is deployed.
- the vehicle is slowed down rapidly from a speed of over 45 mph (70 km/h) and comes to a halt.

► **To switch on the hazard warning lamps:** press button ①.

All turn signals flash. If you now switch on a turn signal using the combination switch, only the turn signal lamp on the corresponding side of the vehicle will flash.

► **To switch off the hazard warning lamps:** press button ①.

If the vehicle returns to a speed of over 6 mph (10 km/h) after a full application of the brakes, the hazard warning lamps are deactivated automatically.

- ❗ The hazard warning lamps still operate if the ignition is switched off.

### Cornering light function

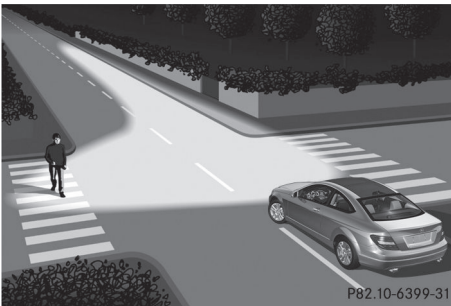

The cornering light function improves the illumination of the road over a wide angle in the direction you are turning, enabling better visibility in tight bends, for example. The cornering light function can only be activated when the low-beam headlamps are switched on.

### Active:

- if you are driving at speeds below 25 mph (40 km/h) and switch on the turn signals or turn the steering wheel
- if you are driving at speeds between 25 mph (40 km/h) and 45 mph (70 km/h) and turn the steering wheel

**Not active:** if you are driving at speeds above 25 mph (40 km/h) or switch off the turn signals or turn the steering wheel to the straight-ahead position.

The cornering light function may remain lit for a short time, but is automatically switched off after no more than three minutes.

### Adaptive Highbeam Assist

You can use this function to set the headlamps to change between low beam and high beam automatically. The system recognizes vehicles with their lights on, either approaching from the opposite direction or traveling in front of your vehicle, and consequently switches the headlamps from high beam to low beam.

The system automatically adapts the low-beam headlamp range depending on the distance to the other vehicle. Once the system no longer detects any other vehicles, it reactivates the high-beam headlamps.

The system's optical sensor is located behind the windshield near the overhead control panel.



- ▶ **To activate:** activate the Adaptive Highbeam Assist function using the on-board computer (▷ page 178).
- ▶ Turn the light switch to **A** or **AUTO**.
- ▶ Press the combination switch beyond the pressure point in the direction of arrow ① (▷ page 101).  
If it is dark and the light sensor activates the low-beam headlamps, the  indicator lamp in the instrument cluster lights up.



If you drive at speeds above approximately 28 mph (45 km/h):

the headlamp range is set automatically depending on the distance between the vehicle and other road users.

If you are driving at speeds above approximately 35 mph (55 km/h) and no other road users have been detected:

the high-beam headlamps are switched on automatically. The  indicator lamp in the instrument cluster also lights up.

If you drive at speeds below approximately 30 mph (45 km/h) or if other road users are identified or if the roads are sufficiently illuminated:

the high-beam headlamps are switched off automatically. The  indicator lamp in the instrument cluster goes out. The 

indicator lamp in the instrument cluster stays on.

- ▶ **To deactivate:** move the combination switch back to its normal position.  
The  indicator lamp in the instrument cluster goes out.

#### **WARNING**

The Adaptive Highbeam Assist is only an aid intended to support you while driving. The driver is and remains responsible for proper vehicle lighting in accordance with the prevailing light, sight and traffic conditions. The system may be impaired or unavailable when

- visibility is poor, e.g. due to snow, rain, fog, or heavy spray
- the optical sensor area of the windshield is dirty, fogged up, or covered by a sticker for example

The system cannot recognize the following road users:

- Road users without a lighting system of their own, e.g. pedestrians
- Road users with dim lighting of their own, e.g. cyclists
- Road users whose lighting is obstructed, e.g. road users behind a guardrail
- In some seldom cases, even road users with a lighting system of their own may be recognized too late or not at all.

The automatic high-beam headlamps will then not be deactivated or it will be activated in spite of preceding or oncoming road users.

This could endanger you and/or others and cause an accident. Always pay close attention to the traffic situation and switch off the high beam manually if necessary.

#### **Headlamps fogged up on the inside**

The headlamps may fog up on the inside if there is high atmospheric humidity.



- ▶ Drive with the headlamps switched on. The level of moisture diminishes, depending on the length of the journey and the weather conditions (humidity and temperature).





If the level of moisture does not diminish:

- ▶ Have the headlamps checked at a qualified specialist workshop.

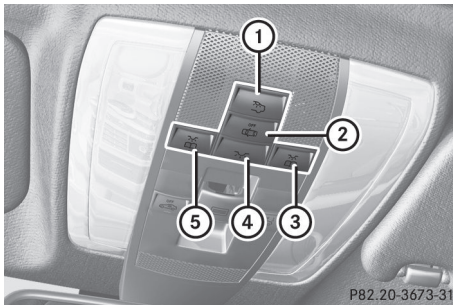
## Interior lighting

### Overview of interior lighting



- ①  Switches the rear interior lighting on/off
- ②  Switches the automatic interior lighting control on/off
- ③  Switches the right-hand front reading lamp on/off
- ④  Switches the front interior lighting on/off
- ⑤  Switches the left-hand front reading lamp on/off

### Interior lighting control

#### Important notes

In order to prevent the vehicle's battery from discharging, the interior lighting functions are automatically deactivated after some time except for when the SmartKey is in position 2 in the ignition lock.

### Automatic interior lighting control



- ▶ **To switch on/off:** press the  button. When the automatic interior lighting control is activated, the button is flush with the overhead control panel.

The interior lighting automatically switches on if you:

- unlock the vehicle
- open a door
- remove the SmartKey from the ignition lock

The interior light is activated for a short while when the SmartKey is removed from the ignition lock. You can activate this delayed switch-off using the on-board computer (> page 179).

### Manual interior lighting control

- ▶ **To switch the interior lighting on/off:** press the  button.
- ▶ **To switch the reading lamps on/off:** press the  button.

### Crash-responsive emergency lighting

The interior lighting is activated automatically if the vehicle is involved in an accident.

- ▶ **To switch off the crash-responsive emergency lighting:** press the hazard warning lamp button.
- or
- ▶ Lock and then unlock the vehicle using the SmartKey.

## Replacing bulbs

### Important safety notes

#### Xenon bulbs

#### DANGER

Xenon bulbs carry a high voltage. You could get an electric shock and be seriously or even fatally injured if you touch the electric



contacts on Xenon bulbs. Therefore, never remove the cover from Xenon bulbs.

Do not change the Xenon bulbs yourself, but have them replaced at a qualified workshop.

If your vehicle is equipped with Xenon bulbs, you can recognize this by the following: the cone of light from the Xenon bulbs moves from the top to the bottom and back again when you start the engine. For this to be observed, the lights must be switched on before starting the engine.

Bulbs and lamps are an important aspect of vehicle safety. You must therefore make sure that these function correctly at all times. Have the headlamp setting checked regularly.

### Other bulbs

There are bulbs other than the Xenon bulbs that you cannot replace. Replace only the bulbs listed (> page 105). Have the bulbs that you cannot replace yourself changed at a qualified specialist workshop.

If you require assistance changing bulbs, consult a qualified specialist workshop.

Do not touch the glass tube of new bulbs with your bare hands. Even minor contamination can burn into the glass surface and reduce the service life of the bulbs. Always use a lint-free cloth or only touch the base of the bulb when installing.

Only use bulbs of the correct type.

If the new bulb still does not light up, consult a qualified specialist workshop.

Bulbs and lamps are an important aspect of vehicle safety. You must therefore make sure that these function correctly at all times. Have the headlamp setting checked regularly.

#### **WARNING**

Bulbs and lamps can become very hot. For this reason, allow them to cool down before changing them. Otherwise, you could burn yourself when you touch them.

Keep bulbs out of the reach of children. Otherwise, they could, for example, damage the bulbs and injure themselves.

Never use a bulb which has been dropped. Such a bulb may explode and injure you.

Halogen bulbs are pressurized and could explode when you change them, especially if they are very hot. You should therefore wear eye protection and gloves when you are changing them.

### Overview: changing bulbs/bulb types

You can change the following bulbs. The bulb type can be found in the legend.

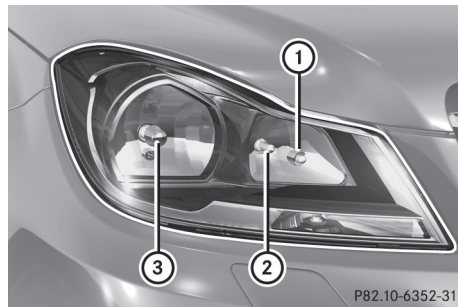

Halogen headlamps

- ① Parking lamp/standing lamp: W 5 W
- ② High-beam headlamp: H7 55 W
- ③ Low-beam headlamp: H7 55 W



Bi-Xenon headlamps

- ① Cornering lamp: H7 55 W

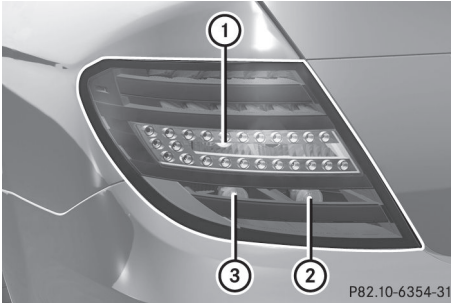

P82.10-6354-31

Tail lamp

- ① Backup lamp: P 21 W
- ② Brake lamp: P 21 W
- ③ Brake lamp/parking lamp: P 21 W

### Changing the front bulbs

#### Low-beam headlamps (halogen headlamps)

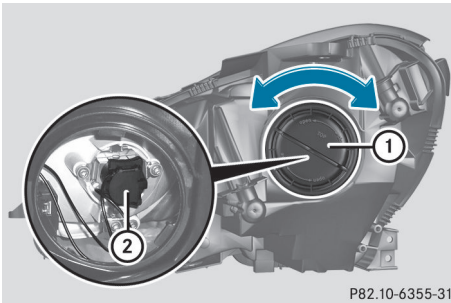

P82.10-6355-31

- ▶ Switch off the lights.
- ▶ Open the hood.
- ▶ Turn housing cover ① counter-clockwise and pull it out.
- ▶ Turn bulb holder ② counter-clockwise and pull it out.
- ▶ Take the bulb out of bulb holder ②.
- ▶ Insert the new bulb into bulb holder ②.
- ▶ Insert bulb holder ② into the lamp and turn it clockwise.
- ▶ Align housing cover ① and turn it clockwise until it engages.

#### High-beam headlamps (halogen headlamps)

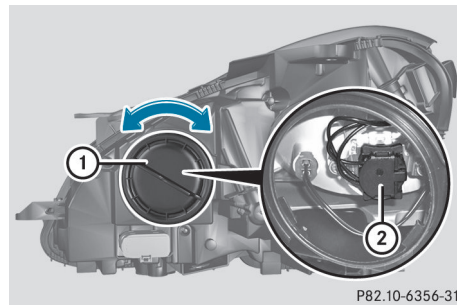

P82.10-6356-31

- ▶ Switch off the lights.
- ▶ Open the hood.
- ▶ Turn housing cover ① counter-clockwise and pull it out.
- ▶ Turn bulb holder ② counter-clockwise and pull it out.
- ▶ Take the bulb out of bulb holder ②.
- ▶ Insert the new bulb into bulb holder ②.
- ▶ Insert bulb holder ② into the lamp and turn it clockwise.
- ▶ Align housing cover ① and turn it clockwise until it engages.

#### Parking lamps/standing lamps (halogen headlamps)

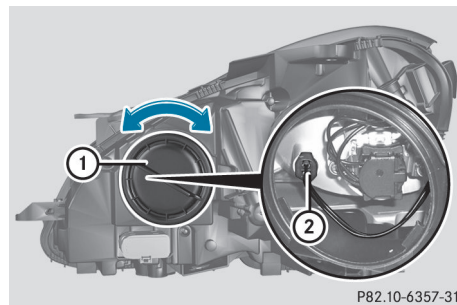

P82.10-6357-31

- ▶ Switch off the lights.
- ▶ Open the hood.
- ▶ Turn housing cover ① counterclockwise and pull it out.
- ▶ Pull out bulb holder ②.

- ▶ Take the bulb out of bulb holder ②.
- ▶ Insert the new bulb into bulb holder ②.
- ▶ Insert bulb holder ②.
- ▶ Align housing cover ① and turn it clockwise until it engages.

### Cornering light function (Bi-Xenon headlamps)

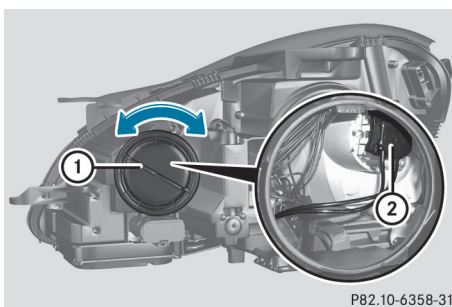

P82.10-6358-31

- ▶ Switch off the lights.
- ▶ Open the hood.
- ▶ Turn housing cover ① counter-clockwise and pull it out.
- ▶ Turn bulb holder ② counter-clockwise and pull it out.
- ▶ Take the bulb out of bulb holder ②.
- ▶ Insert the new bulb into bulb holder ②.
- ▶ Insert bulb holder ② into the lamp and turn it clockwise.
- ▶ Align housing cover ① and turn it clockwise until it engages.

### Changing the rear bulbs

#### Opening and closing the side trim panels

You must open the side trim panel in the trunk and remove the first-aid kit before you can change the bulbs in the tail lamps.

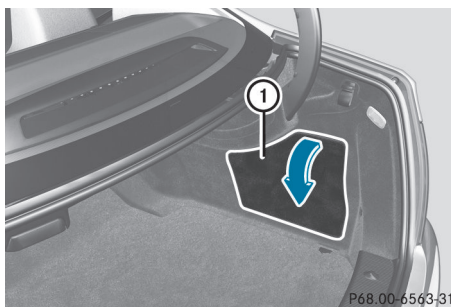

P68.00-6563-31

Right-hand side trim panel

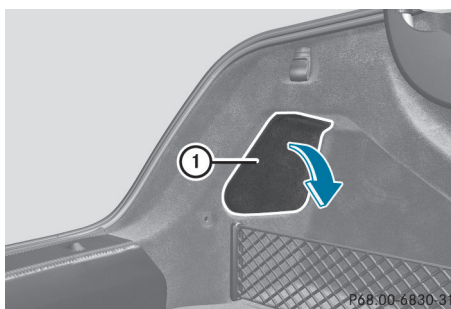

P68.00-6830-31

Left-hand side trim panel (vehicles without a sound system or trailer coupling)

- ▶ **To open:** loosen side trim panel ① at the top and fold it down in the direction of the arrow.
- ▶ **To close:** insert side panel ①.

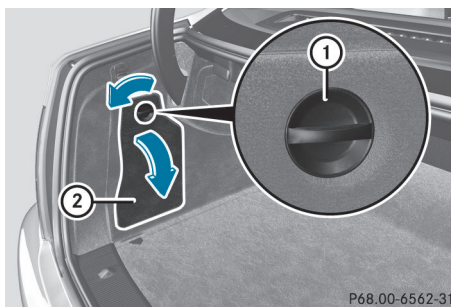

P68.00-6562-31

Left-hand side trim panel (vehicles with a sound system or trailer coupling)

- ▶ **To open:** turn rotary catch ① 90° in the direction of the arrow and remove side trim panel ②.
- ▶ **To close:** insert side trim panel ② and turn rotary catch ① 90° in the opposite direction to the arrow.

### Tail lamp

- ▶ Switch off the lights.
- ▶ Open the trunk.
- ▶ Open the side trim panel (▷ page 107).

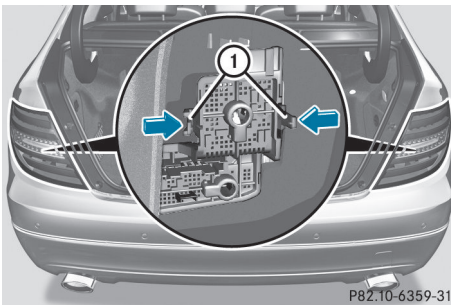

P82.10-6359-31

- ▶ Remove the tail lamp connector
- ▶ Simultaneously press retaining lugs ① in the direction of the arrow and slightly pull out the bulb holder with the bulbs.
- ▶ Remove the connector for LED light functions from the top of the bulb holder.
- ▶ Pull the bulb holder out with the bulbs.

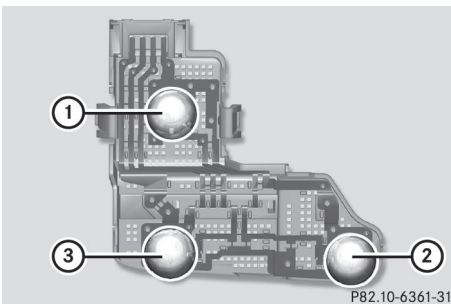

P82.10-6361-31

- ① Backup lamp
- ② Brake lamp
- ③ Parking lamp/brake lamp

- ▶ Press the respective bulb ①, ② or ③ back and turn it counter-clockwise to remove it from the bulb holder.
- ▶ Insert the new bulb into the bulb holder and turn it clockwise.
- ▶ Reinsert the connector for LED light functions in the bulb holder.
- ▶ Insert the bulb holder again and lock it in place.
- ▶ Insert the tail lamp connector.
- ▶ Close the side trim panel (▷ page 107).

### Windshield wipers

#### Switching the windshield wipers on/off

#### ⚠ WARNING

Wiper blades are components that are subject to wear and tear. Replace the wiper blades twice a year, preferably in the spring and fall. Otherwise the windshield will not be wiped properly. As a result, you may not be able to observe surrounding traffic conditions and could cause an accident.

- ❗ Do not operate the windshield wipers when the windshield is dry, as this could damage the wiper blades. Moreover, dust that has collected on the windshield can scratch the glass if wiping takes place when the windshield is dry.
- ❗ If the windshield wipers leave smears on the windshield after the vehicle has been washed in an automatic car wash, wax or other residues may be the reason for this. Clean the windshield using washer fluid after washing the vehicle in an automatic car wash.

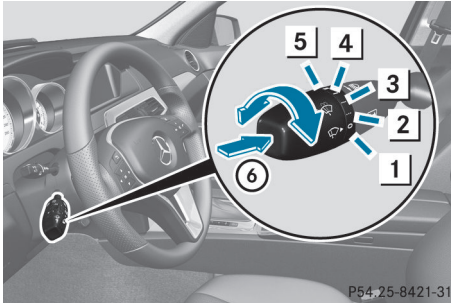

#### Combination switch

- 1  0 Windshield wipers off
- 2  ... Intermittent wipe, low<sup>6</sup>
- 3  .... Intermittent wipe, high<sup>7</sup>
- 4  — Continuous wipe, slow
- 5  = Continuous wipe, fast
- 6  Single wipe /  To wipe the windshield using washer fluid

- ▶ Switch on the ignition.
- ▶ Turn the combination switch to the corresponding position.

**!** Intermittent wiping with rain sensor: due to optical influences and the windshield becoming dirty in dry weather conditions, the windshield wipers may be activated inadvertently. This could then damage the windshield wiper blades or scratch the windshield.

For this reason, you should always switch off the windshield wipers in dry weather.

In the  ... or  .... position, the appropriate wiping frequency is set automatically according to the intensity of the rain. In the  .... position, the rain sensor is more sensitive than in the  ... position, causing the windshield wipers to wipe more frequently.

<sup>6</sup> Rain sensor set to low sensitivity.

<sup>7</sup> Rain sensor set to high sensitivity.

## Replacing the wiper blades

### Important safety notes

#### WARNING

For safety reasons, switch off the windshield wipers and remove the SmartKey from the ignition lock before changing the wiper blades (vehicles with KEYLESS-GO: make sure that the on-board electronics are in state 0). Otherwise, the wiper motor could be switched on suddenly and cause injury.

**!** Never open the hood if a windshield wiper arm has been folded away from the windshield.

Never fold a windshield wiper arm without a wiper blade back onto the windshield.

Hold the windshield wiper arm firmly when you change the wiper blade. If you release the windshield wiper arm without a wiper blade and it falls onto the windshield, the windshield may be damaged by the force of the impact.

Mercedes-Benz recommends that you have the wiper blades replaced by a qualified specialist workshop, e.g. at an authorized Mercedes-Benz Center.

**!** To avoid damaging the wiper blades, make sure that you touch only the wiper arm of the wiper.

Depending on the equipment level of your vehicle, there are two variants of wiper blade; these are installed and removed in different ways. Based on the diagrams, check which system is installed.



### Replacing the wiper blades, option 1

#### Removing the wiper blades

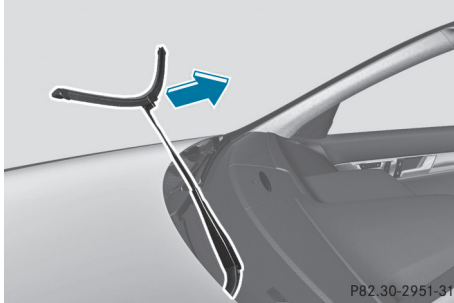

- ▶ Remove the wiper blade from the retaining pin on the wiper arm in the direction of the arrow.

#### Installing the wiper blades

- ▶ Push the new wiper blade onto the retaining pin on the wiper arm in the opposite direction to the arrow. Make sure that the wiper blade slides fully onto the retaining pin on the wiper arm.
- ▶ Turn the wiper blade parallel to the wiper arm.
- ▶ Fold the wiper arm back onto the windshield.

### Replacing the wiper blades, option 2

#### Removing the wiper blades

- ▶ Remove the SmartKey from the ignition lock.
- ▶ Fold the wiper arm away from the windshield.

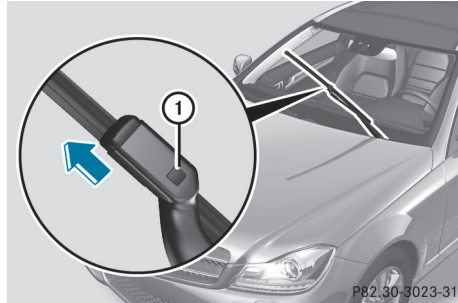

- ▶ Firmly press release knob ① and pull the wiper blade upwards from the wiper arm in the direction of the arrow.

#### Installing the wiper blades

- ▶ Position the new wiper blade in the retainer on the wiper arm and slide it into place in the opposite direction to the arrow. The wiper blade audibly engages.
- ▶ Make sure that wiper blade is seated correctly.
- ▶ Fold the wiper arm back onto the windshield.

### Problems with the windshield wipers

#### The windshield wipers are obstructed

Leaves or snow, for example, may be obstructing the windshield wiper movement. The wiper motor has been deactivated.

- ▶ For safety reasons, you should remove the SmartKey from the ignition lock.

or

- ▶ Switch off the engine using the Start/Stop button and open the driver's door.
- ▶ Remove the cause of the obstruction.
- ▶ Switch the windshield wipers back on.

#### The windshield wipers are inoperative

The windshield wiper drive is malfunctioning.

- ▶ Select another wiper speed on the combination switch.
- ▶ Have the windshield wipers checked at a qualified specialist workshop.

### **The spray nozzles are misaligned**

---

The windshield washer fluid from the spray nozzles no longer hits the center of the windshield. The spray nozzles are misaligned.

- ▶ Have the spray nozzles adjusted at a qualified specialist workshop.





Useful information .....	114
Overview of climate control systems .....	114
Operating the climate control systems .....	117
Setting the air vents .....	120

### Useful information

- i** This Operator's Manual describes all models and all standard and optional equipment of your vehicle available at the time of publication of the Operator's Manual. Country-specific differences are possible. Please note that your vehicle may not be equipped with all features described. This also applies to safety-related systems and functions.
- i** Please read the information on qualified specialist workshops (▷ page 23).

convenience opening feature (▷ page 79). This will speed up the cooling process and the desired vehicle interior temperature will be reached more quickly.

- i** The integrated filter can filter out most particles of dust, and completely filters out pollen. A clogged filter reduces the amount of air supplied to the vehicle interior. For this reason, you should always observe the interval for replacing the filter, which is specified in the Maintenance Booklet. As it depends on environmental conditions, e.g. heavy air pollution, the interval may be shorter than stated in the Maintenance Booklet.

### Overview of climate control systems

#### Important safety notes

##### WARNING

Severe conditions (e.g. strong air pollution) may require replacement of the filter before its scheduled replacement interval. A clogged filter will reduce the air volume to the interior and the windows could fog up, impairing visibility and endangering you and others. Have a blocked filter replaced at a Mercedes-Benz Center as soon as possible.

##### WARNING

Follow the recommended settings for heating and cooling given on the following pages. Otherwise, the windows could fog up, impairing visibility and endangering you and others.

Automatic climate control controls the temperature and the humidity in the vehicle interior and filters undesirable substances from the air.

Automatic climate control is only operational when the engine is running. Optimum operation is only achieved if you drive with the side windows and panorama roof with power tilt/sliding panel closed.

- i** Ventilate the vehicle for a brief period during warm weather, e.g. using the

## Control panel for dual-zone climate control

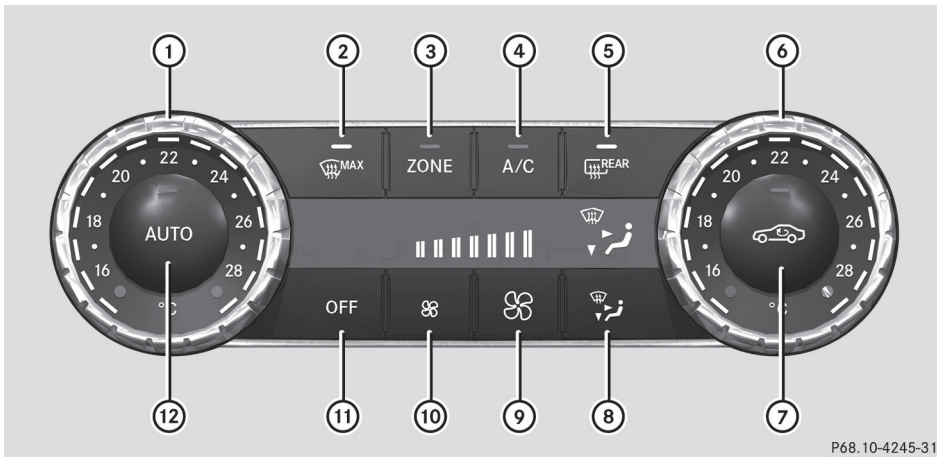

Canada only

- ① To set the temperature, left (▷ page 118)
- ② To defrost the windshield (▷ page 119)
- ③ To switch the ZONE function on/off (▷ page 118)
- ④ To activate/deactivate cooling with air dehumidification (▷ page 117)
- ⑤ To switch the rear window defroster on/off (▷ page 120)
- ⑥ To set the temperature, right (▷ page 118)
- ⑦ To activate/deactivate air-recirculation mode (▷ page 120)
- ⑧ To set the air distribution (▷ page 118)
- ⑨ To increase the airflow (▷ page 118)
- ⑩ To reduce the airflow (▷ page 118)
- ⑪ To switch climate control on/off (▷ page 117)
- ⑫ To set climate control to automatic (▷ page 117)

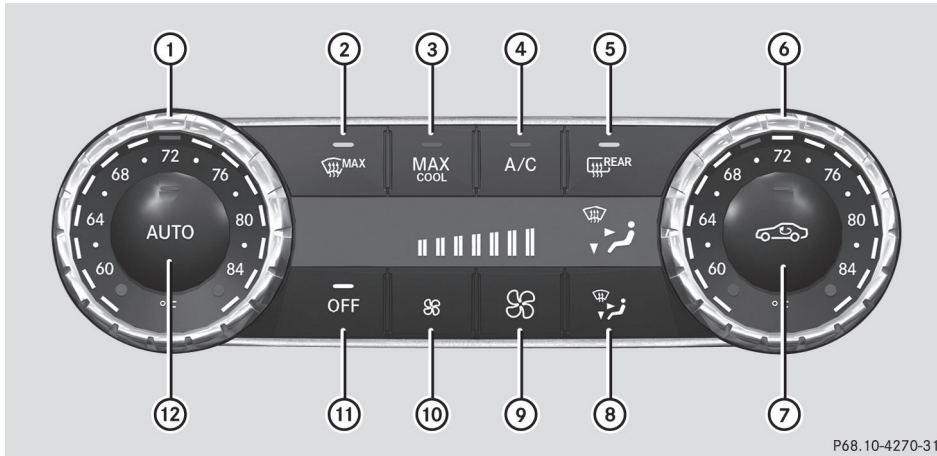

P68.10-4270-31

## Climate control

USA only

- ① To set the temperature, left (▷ page 118)
- ② To defrost the windshield (▷ page 119)
- ③ To switch maximum cooling MAX COOL on/off (▷ page 119)
- ④ To activate/deactivate cooling with air dehumidification (▷ page 117)
- ⑤ To switch the rear window defroster on/off (▷ page 120)
- ⑥ To set the temperature, right (▷ page 118)
- ⑦ To activate/deactivate air-recirculation mode (▷ page 120)
- ⑧ To set the air distribution (▷ page 118)
- ⑨ To increase the airflow (▷ page 118)
- ⑩ To reduce the airflow (▷ page 118)
- ⑪ To switch climate control on/off (▷ page 117)
- ⑫ To set climate control to automatic (▷ page 117)

### Notes on using automatic climate control

The following contains notes and recommendations on optimum use of automatic climate control.

- Activate climate control using the **AUTO** and **A/C** buttons. The indicator lamps in the **AUTO** and **A/C** buttons light up.
- Set the temperature to 72 °F (22 °C).
- Only use the "defrosting" function briefly until the windshield is clear again.
- Only use "air-recirculation" mode briefly, e.g. if there are unpleasant outside odors

or when in a tunnel. The windows could otherwise fog up as in air-recirculation mode no fresh air is drawn into the vehicle.

- Use the ZONE function to adopt the temperature settings on the driver's side for the front-passenger side as well. The indicator lamp in the **ZONE** button goes out.

## Operating the climate control systems

### Activating/deactivating climate control

#### Important information

##### WARNING

When the climate control system is deactivated, the outside air supply and circulation are also deactivated. Only choose this setting for a short time. Otherwise the windows could fog up, impairing visibility and endangering you and others.

-  Switch on climate control primarily using the **AUTO** button (► page 117).

#### Activating/deactivating

- Turn the SmartKey to position **2** in the ignition lock.
- **To switch on:** press the **AUTO** button. The indicator lamp in the **AUTO** button lights up. Airflow and air distribution are set to automatic mode.

or

- Press the **OFF** button. The indicator lamp in the **OFF** button goes out. The previously selected settings come into effect again.
- **To switch off:** press the **OFF** button. The indicator lamp in the **OFF** button lights up.

### Activating/deactivating cooling with air dehumidification

#### Important information

The cooling with air dehumidification function is only available when the engine is running. The air inside the vehicle is cooled and dehumidified according to the temperature selected.

##### WARNING

If you switch off the cooling function, the vehicle will not be cooled when weather conditions are warm. The windows can fog up more quickly. Window fogging may impair visibility and endanger you and others.

Condensation may drip from the underside of the vehicle when it is in cooling mode. This is normal and not a sign that there is a malfunction.

-  The cooling with air dehumidification function uses refrigerant R134a. This coolant does not contain chlorofluorocarbons, and therefore does not damage the ozone layer.

#### Activating/deactivating

- **To activate:** press the **A/C** button. The indicator lamp in the **A/C** button lights up.
- **To switch off:** press the **A/C** button. The indicator lamp in the **A/C** button goes out. The cooling with air dehumidification function has a delayed switch-off feature.

#### Problems with the cooling with air dehumidification function

When you press the **A/C** button, the indicator lamp in the button flashes three times or remains off. You can no longer switch on the cooling with air dehumidification function.

- Consult a qualified specialist workshop.



#### Setting climate control to automatic

##### WARNING

If you switch off the cooling function, the vehicle will not be cooled when weather conditions are warm. The windows can fog up more quickly. Window fogging may impair visibility and endanger you and others.

In automatic mode, the set temperature is maintained automatically at a constant level. The system automatically regulates the temperature of the dispensed air, the airflow and the air distribution.

Automatic mode will achieve optimal operation if cooling with air dehumidification is also activated. If desired, cooling with air dehumidification can be deactivated.

- ▶ Turn the SmartKey to position **2** in the ignition lock.
  - ▶ Set the desired temperature.
  - ▶ **To activate:** press the **AUTO** button. The indicator lamp in the **AUTO** button lights up. Automatic air distribution and airflow are activated.
  - ▶ **To switch off:** press the  button.
- or
- ▶ Press the  or  button. The indicator lamp in the **AUTO** button goes out. Automatic air distribution and airflow are deactivated.







### Setting the temperature

Different temperatures can be set for the driver's and front-passenger sides.

- ▶ Turn the SmartKey to position **2** in the ignition lock.
- ▶ **To increase/reduce:** turn controls ① and ② clockwise or counter-clockwise (▷ page 115).  
Only change the temperature setting in small increments. Start at 72 °C (22 °C).

### Setting the air distribution



#### Air distribution settings

-  Directs air through the center and side air vents
-  Directs the airflow through the footwell air vents
-  Directs air through the center, side and footwell vents
-  Directs air through the defroster vents
-  Directs the airflow through the defroster, center and side air vents<sup>8</sup>
-  Directs air through the defroster and footwell vents
-  Directs the airflow through the defroster, center and side air vents as well as the footwell air vents<sup>8</sup>

**i** Regardless of the air distribution setting, airflow is always directed through the side air vents.. The side air vents can only be closed when the controls on the side air vents are turned downwards.

- ▶ Turn the SmartKey to position **2** in the ignition lock.
- ▶ Press the  button repeatedly until the desired symbol appears in the display. The indicator lamp in the **AUTO** button goes out. Automatic control is deactivated and the air distribution is controlled according to the selected setting.

### Setting the airflow



- ▶ Turn the SmartKey to position **2** in the ignition lock.
- ▶ **To increase/reduce:** press the  or  button.

### Switching the ZONE function on/off



This function is only available in vehicles for Canada.

<sup>8</sup> Canada only.







- ▶ **To switch on:** press the  button.  
The indicator lamp in the  button lights up.  
The temperature setting for the driver's side is not adopted for the front-passenger side.

When the buttons for temperature, airflow or air distribution are activated, the temperature setting for the driver's side is not adopted for the other climate control zones.

- ▶ **To switch off:** press the  button.  
The indicator lamp in the  button goes out.  
The temperature setting for the driver's side is adopted for the front-passenger side.



### Defrosting the windshield

You can use this function to defrost the windshield or to defrost the inside of the windshield and the side windows.



- ▶ **i** You should only select the defrosting function until the windshield is clear again.
- ▶ Turn the SmartKey to position **2** in the ignition lock.
- ▶ **To activate:** press the  button.  
The indicator lamp in the  button lights up.  
The climate control system switches to the following functions:
  - cooling with air dehumidification on
  - high airflow<sup>9</sup>
  - high temperature<sup>9</sup>
  - air distribution to the windshield and front side windows
  - air-recirculation mode off
- ▶ **To switch off:** press the  button.  
The indicator lamp in the  button goes out. The previously selected settings come into effect again. The cooling with air

dehumidification function remains on. Air-recirculation mode remains deactivated.

or

- ▶ Press the  button.  
The indicator lamp in the  button goes out. Airflow and air distribution are set to automatic mode.

or

- ▶ Turn temperature control  or  clockwise or counter-clockwise (▷ page 115).

or

- ▶ Press the  or  button.



### MAX COOL maximum cooling

The MAX COOL function is only available in vehicles for the USA.

MAX COOL is only operational when the engine is running.



When you activate MAX COOL, climate control switches to the following functions:

- maximum cooling
- maximum airflow
- air-recirculation mode on

- ▶ **To activate:** press the  button.  
The indicator lamp in the button lights up.
- ▶ **To deactivate:** press the  button again.  
The indicator lamp goes out. The previously selected settings come into effect again.

### Defrosting the windows



#### Windows fogged up on the inside

- ▶ Activate the cooling with air dehumidification function .
- ▶ Activate automatic mode .
- ▶ If the windows continue to fog up, activate the defrosting function (▷ page 119).

<sup>9</sup> Depending on the outside temperature.

- i** You should only select this setting until the windshield is clear again.

### Windows fogged up on the outside

- ▶ Switch on the windshield wipers.
- ▶ Press the  button repeatedly until the  or  symbol appears in the display.

- i** You should only select this setting until the windshield is clear again.

### Rear window defroster



#### Activating/deactivating

##### WARNING

Any accumulation of snow and ice should be removed from the rear window before driving. Visibility could otherwise be impaired, endangering you and others.

The rear window defroster has a high current draw. You should therefore switch it off as soon as the window is clear. Otherwise, the rear window defroster switches off automatically after several minutes.

If the battery voltage is too low, the rear window defroster may switch off.

- ▶ Turn the SmartKey to position **2** in the ignition lock.
- ▶ Press the  button. The indicator lamp in the  button lights up or goes out.

#### Problems with the rear window defroster

The rear window defroster has deactivated prematurely or cannot be activated.



- ▶ Switch off any consumers that are not required, e.g. reading lamps or interior lighting. When the battery is sufficiently charged, the rear window defroster is activated again automatically.

#### Activating/deactivating air-recirculation mode



You can deactivate the flow of fresh air if unpleasant odors are entering the vehicle from outside. The air already inside the vehicle will then be recirculated.

##### WARNING

Fogged windows impair visibility, endangering you and others. If the windows begin to fog on the inside, switching off the air recirculation mode immediately should clear interior window fogging. If interior window fogging persists, make sure the air conditioning is activated, or press the  button.

- ▶ Turn the SmartKey to position **2** in the ignition lock.
- ▶ **To activate:** press the  button. The indicator lamp in the  button lights up.

- i** In the event of high pollution levels or at high outside temperatures, air-recirculation mode is automatically activated. When air-recirculation mode is activated automatically, the indicator lamp in the  button is not lit. Outside air is added after about 30 minutes.

- ▶ **To deactivate:** press the  button. The indicator lamp in the  button goes out.

#### Setting the air vents

#### Important safety notes

##### WARNING

When operating the climate control, the air that enters the passenger compartment through the air vents can be very hot or very cold (depending on the set temperature). This could cause burns or frostbite to unprotected skin in the immediate area of the air vents.

Always keep sufficient distance between unprotected parts of the body and the air vents. If necessary, use the air distribution adjustment to direct the air to air vents in the vehicle interior that are not in the immediate area of unprotected skin.

In order to ensure the direct flow of fresh air through the air vents into the vehicle interior, please observe the following notes:

- never cover the air vents or air intake grille in the vehicle interior.
- ❗ For virtually draft-free ventilation, adjust the sliders of the air vents to the center position.

### Setting the center air vents

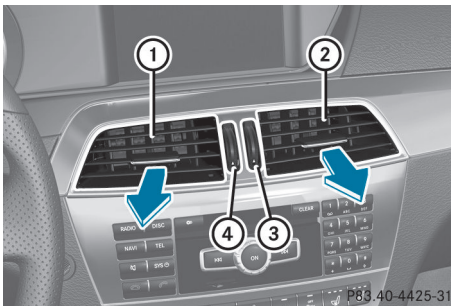

- ① Center air vent, left
- ② Center air vent, right
- ③ Center vent thumbwheel, right
- ④ Center vent thumbwheel, left

► **To open/close:** turn thumbwheels ③ and ④ up or down.

### Setting the side air vents

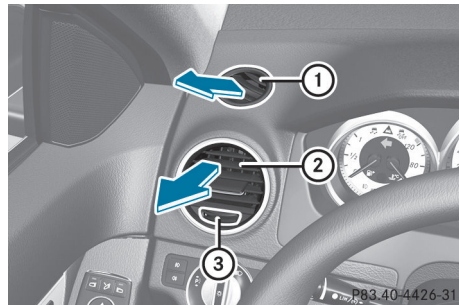

► **To open/close:** turn thumbwheel ③ to the left or right.

- ❗ Side window defroster vent ① is never completely shut, even if side air vent ② is shut.

### Setting the glove box air vent

When automatic climate control is activated, the glove box can be ventilated, for instance to cool its contents. The level of airflow depends on the airflow and air distribution settings.

❗ Close the air vent when heating the vehicle.

At high outside temperatures, open the air vent and activate the "cooling with air dehumidification" function. Otherwise, temperature-sensitive items stored in the glove box could be damaged.

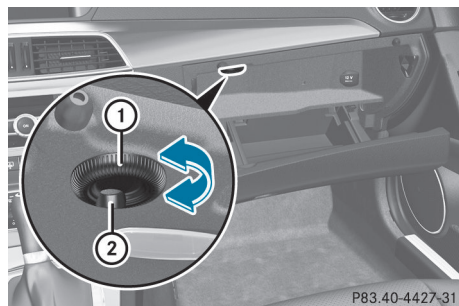

- ① Air vent thumbwheel
- ② Air vent

- ▶ **To open/close:** turn thumbwheel ① clockwise or counter-clockwise.

### Setting the rear-compartment air vents

#### Setting the center vents in the rear compartment

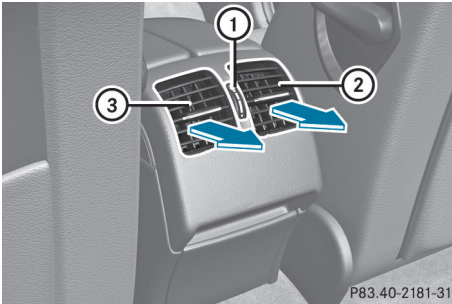

- ① Rear-compartment air vent thumbwheel
- ② Rear-compartment air vent, right
- ③ Rear-compartment air vent, left

- ▶ **To open/close:** turn thumbwheel ① up or down.

Useful information .....	124
Breaking-in notes .....	124
Driving .....	124
Automatic transmission .....	130
Refueling .....	137
Parking .....	140
Driving tips .....	142
Driving systems .....	146

### Useful information

- i** This Operator's Manual describes all models and all standard and optional equipment of your vehicle available at the time of publication of the Operator's Manual. Country-specific differences are possible. Please note that your vehicle may not be equipped with all features described. This also applies to safety-related systems and functions.
- i** Please read the information on qualified specialist workshops (▷ page 23).

### Breaking-in notes

#### The first 1,000miles (1,500 km)

The more you look after the engine when it is new, the more satisfied you will be with its performance in the future.

- You should therefore drive at varying vehicle and engine speeds for the first 1,000miles (1,500km).
  - Avoid heavy loads, e.g. driving at full throttle, during this period.
  - Change gear in good time, before the tachometer needle is  $\frac{2}{3}$  of the way to the red area of the tachometer.
  - If possible, for the first 1,000miles (1,500km), drive in drive program **E** (in AMG vehicles in drive program **C**).
  - Do not manually shift to a lower gear to brake the vehicle.
  - If possible, do not depress the accelerator pedal past the point of resistance (kickdown).
  - Only select shift ranges **3**, **2** or **1** when driving slowly, e.g. in mountainous terrain.
- After 1,000 miles (1,500km), you can increase the engine speed gradually and bring the vehicle up to full speed.

Additional breaking-in notes for AMG vehicles:

- do not drive faster than 85 mph (140 km/h) for the first 1,000 miles (1,500 km).
  - only allow the engine to reach a maximum engine speed of 4,500 rpm briefly.
  - change gear in good time.
- i** You should also observe these breaking-in notes if the engine or parts of the drive train on your vehicle have been replaced.
  - i** Always observe the respective speed limits.

#### AMG vehicles with rear axle locking differential

Your vehicle is equipped with a self-locking differential on the rear axle. To improve the protection of the differential on the rear axle, change the oil after a break-in distance of 2,000 miles (3,000 km). This oil change extends the service life of the differential. Have the oil change carried out at a qualified specialist workshop.

### Driving

#### Important safety notes

##### WARNING

Make sure absolutely no objects are obstructing the pedals' range of movement. Keep the driver's footwell clear of all obstacles. If there are any floor mats or carpets in the footwell, make sure the pedals still have sufficient clearance.

During sudden driving or braking maneuvers the objects could get caught between the pedals. You could then no longer brake or accelerate. This could lead to accidents and injury.

### WARNING

On slippery road surfaces, never downshift in order to obtain braking action. This could result in drive wheel slip and reduced vehicle control. Your vehicle's ABS will not prevent this type of loss of control.

### WARNING

It is dangerous to shift the automatic transmission out of parking position **P** or neutral position **N** if the engine speed is higher than idle speed. If your foot is not firmly on the brake pedal, the vehicle could accelerate quickly forward or in reverse. You could lose control of the vehicle and hit someone or something. Only shift into gear when the engine is idling normally and when your right foot is firmly on the brake pedal.

**!** Warm up the engine quickly. Do not use the engine's full performance until it has reached operating temperature.

Only shift the automatic transmission to the desired drive position when the vehicle is stationary.

Where possible, avoid spinning the drive wheels when pulling away on slippery roads. You could otherwise damage the drive train.

**!** **AMG vehicles:** at low engine oil temperatures below 68 °F (+20 °C), the maximum engine speed is restricted in order to protect the engine. To protect the engine and maintain smooth engine operation, avoid driving at full throttle when the engine is cold.

## SmartKey positions

### SmartKey

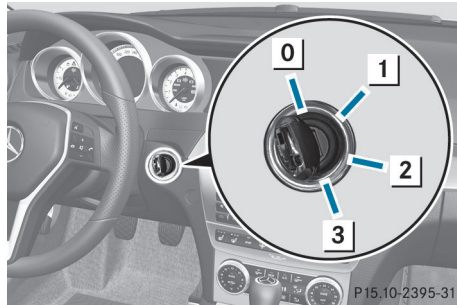

- 0** To remove the SmartKey (shift the transmission to position **P**)
- 1** Power supply for some consumers, such as the windshield wipers
- 2** Ignition (power supply for all consumers and drive position)
- 3** To start the engine

If the SmartKey is in position **0** in the ignition lock for an extended period of time, it can no longer be turned in the ignition lock. The steering is then locked. To unlock, remove the SmartKey and reinsert it into the ignition lock. The steering is locked when you remove the SmartKey from the ignition lock.

- i** The SmartKey can be turned in the ignition lock even if it is not the correct SmartKey for the vehicle. The ignition is not switched on. The engine cannot be started.

## KEYLESS-GO

### General information

Vehicles with KEYLESS-GO are equipped with a SmartKey featuring an integrated KEYLESS-GO function and a detachable Start/Stop button.

The Start/Stop button must be inserted into the ignition lock and the SmartKey must be in the vehicle.

Pressing the Start/Stop button several times in succession corresponds to the different



SmartKey positions in the ignition lock. This is only the case if you are not depressing the brake pedal.

If you depress the brake pedal and press the Start/Stop button, the engine starts immediately.

The Start/Stop button can be removed from the ignition lock. Then, you can insert the SmartKey into the ignition lock.

- i** You do not have to remove the Start/Stop button from the ignition lock when you leave the vehicle. However, you should always take the SmartKey with you when leaving the vehicle. The vehicle can be started with the Start/Stop button if the SmartKey is in the vehicle.

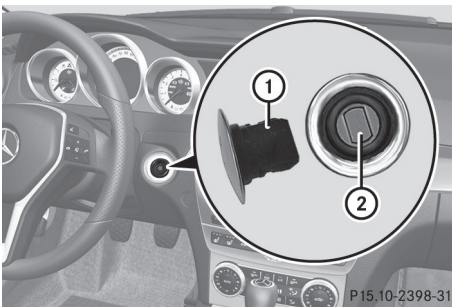

- ① Start/Stop button
- ② Ignition lock

▶ Insert Start/Stop button ① into ignition lock ②.

- i** When you insert Start/Stop button ① into ignition lock ②, the system requires a detection time of approximately two seconds before you can use Start/Stop button ①.

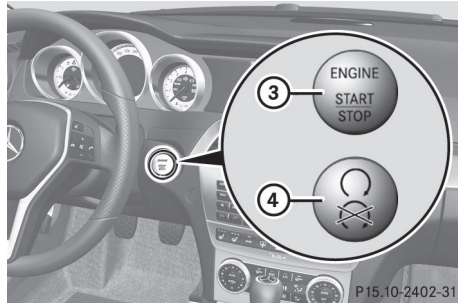

Start/Stop button

- ③ USA only
- ④ Canada only

- ▶ Position 0: if Start/Stop button ① has not yet been pressed, this corresponds to the SmartKey being removed from the ignition.
- ▶ Position 1: press Start/Stop button ①. You can now activate the windshield wipers, for example.

- i** If you then open the driver's door when in this position, the power supply is deactivated.
- ▶ Position 2 (ignition): press Start/Stop button ① twice.

- i** If you press Start/Stop button ① once when in this position and the driver's door is open, the power supply is deactivated again.

As soon as the ignition is switched on, all the indicator lamps in the instrument cluster light up. If an indicator lamp does not go out after the engine is started or if it lights up while the vehicle is in motion, see (▶ page 212).

## Starting the engine

### Important safety notes

#### WARNING

Inhalation of exhaust gas is hazardous to your health. All exhaust gas contains carbon monoxide (CO), and inhaling it can cause unconsciousness and possible death.

Do not run the engine in confined areas (such as a garage) which are not properly ventilated. If you think that exhaust gas fumes are entering the vehicle while driving, have the cause determined and corrected immediately. If you must drive under these conditions, drive only with at least one window fully open at all times.

**!** Do not depress the accelerator pedal when starting the engine.

### General information

**i** The catalytic converter is preheated for up to 30seconds after a cold start. The sound of the engine may change during this time.

### Automatic transmission

- ▶ Shift the transmission to position **P**.  
The transmission position display in the multifunction display shows **P**.
- i** You can also start the engine when the transmission is in position **N**.

### Starting procedure with the SmartKey

- ▶ Turn the SmartKey to position **3** in the ignition lock (▷ page 125) and release it as soon as the engine is running.

### Using KEYLESS-GO to start the engine

#### **!** WARNING

As long as the SmartKey is in your vehicle, the vehicle can be started. Therefore, never leave children unattended in the vehicle, as they could otherwise accidentally start the engine. When leaving the vehicle, always take the SmartKey with you and lock the vehicle. Do not leave children unattended in the vehicle, or with access to an unlocked vehicle. A child's unsupervised access to a vehicle could result in an accident and/or serious personal injury.

**i** The Start/Stop button can be used to start the vehicle without inserting the SmartKey into the ignition lock. The Start/Stop button must be inserted into the ignition lock and the SmartKey must be in the vehicle.

- ▶ Depress the brake pedal and keep it depressed.
- ▶ Press the Start/Stop button (▷ page 125) once.  
The engine starts.

### Pulling away

### Automatic transmission

#### **!** WARNING

It is dangerous to shift the automatic transmission out of parking position **P** or neutral position **N** if the engine speed is higher than idle speed. If your foot is not firmly on the brake pedal, the vehicle could accelerate quickly forward or in reverse. You could lose control of the vehicle and hit someone or something. Only shift into gear when the engine is idling normally and when your right foot is firmly on the brake pedal.

**i** It is only possible to shift the transmission from position **P** to the desired position if you depress the brake pedal. Only then is the selector lever lock released.

- ▶ Depress the brake pedal and keep it depressed.
- ▶ Shift the transmission to position **D** or **R**.
- ▶ Release the parking brake (▷ page 141).
- ▶ Release the brake pedal.
- ▶ Carefully depress the accelerator pedal.

**!** If a warning tone sounds and the **Release Park. Brake** message appears in the multifunction display, the parking brake is still applied. Release the parking brake.

**i** The vehicle locks centrally once you have pulled away. The locking knobs in the doors drop down.

You can open the doors from the inside at any time.

You can also deactivate the automatic locking feature (▷ page 179).

**i** Upshifts take place at higher engine speeds after a cold start. This helps the catalytic converter to reach its operating temperature more quickly.

### Hill start assist

Hill start assist helps you when pulling away forwards or in reverse on an uphill gradient. It holds the vehicle for a short time after you have removed your foot from the brake pedal. This gives you enough time to move your foot from the brake pedal to the accelerator pedal and to depress it before the vehicle begins to roll.

#### **WARNING**

Never leave the vehicle when it is held by hill start assist. After approximately one second, hill start assist will no longer brake your vehicle and it could roll away.

▶ Take your foot off the brake pedal.

**i** Once you have taken your foot off the brake pedal, the vehicle is held for around one second.

▶ Pull away.

Hill start assist will not function if:

- you are pulling away on a level road or on a downhill gradient.
- the transmission is in position **N**.
- the parking brake is applied.
- ESP® is malfunctioning.

### Problems with the engine

Problem	Possible causes/consequences and ► Solutions
The engine does not start. The starter motor can be heard.	<ul style="list-style-type: none"> <li>• There is a malfunction in the engine electronics.</li> <li>• There is a malfunction in the fuel supply.</li> </ul> <p>► Before attempting to start the engine again, turn the SmartKey in the ignition back to position <b>0</b> or press the Start/Stop button repeatedly until all indicator lamps in the instrument cluster go out.</p> <p>► Try to start the engine again (▷ page 126). Avoid excessively long and frequent attempts to start the engine as these will drain the battery.</p> <p>If the engine does not start after several attempts:</p> <p>► Consult a qualified specialist workshop.</p>
The engine does not start. You cannot hear the starter motor.	<p>The on-board voltage is too low because the battery is too weak or discharged.</p> <p>► Jump-start the vehicle (▷ page 269).</p> <p>If the engine does not start despite attempts to jump-start it:</p> <p>► Consult a qualified specialist workshop.</p> <p>The starter motor was exposed to a thermal load that was too high.</p> <p>► Allow the starter motor to cool down for approximately two minutes.</p> <p>► Try to start the engine again.</p> <p>If the engine still does not start:</p> <p>► Consult a qualified specialist workshop.</p>
The engine is not running smoothly and is misfiring.	<p>There is a malfunction in the engine electronics or in a mechanical component of the engine management system.</p> <p>► Only depress the accelerator pedal slightly. Otherwise, non-combusted fuel may get into the catalytic converter and damage it.</p> <p>► Have the cause rectified immediately at a qualified specialist workshop.</p>
The coolant temperature gauge shows a value above 248 °F (120 °C).	<p>The coolant level is too low. The coolant is too hot and the engine is no longer being cooled sufficiently.</p> <p>► Stop as soon as possible and allow the engine and the coolant to cool down.</p> <p>► Check the coolant level (▷ page 248). Observe the warning notes as you do so and add coolant if necessary.</p>

## Automatic transmission

### Important safety notes

#### WARNING

It is dangerous to shift the automatic transmission out of parking position **P** or neutral position **N** if the engine speed is higher than idle speed. If your foot is not firmly on the brake pedal, the vehicle could accelerate quickly forward or in reverse. You could lose control of the vehicle and hit someone or something. Only shift into gear when the engine is idling normally and when your right foot is firmly on the brake pedal.

#### WARNING

Keep in mind that turning off the engine alone only will shift the automatic transmission into neutral position **N** automatically.

Always shift the automatic transmission into park position **P** before turning off the engine. Otherwise the vehicle could roll away which could result in an accident and/or serious personal injury.

## Selector lever

### Overview of transmission positions

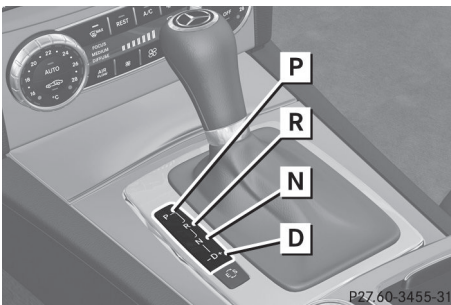

Example: selector lever

- P** Park position with selector lever lock
- R** Reverse gear
- N** Neutral
- D** Drive

### Transmission position and drive program display

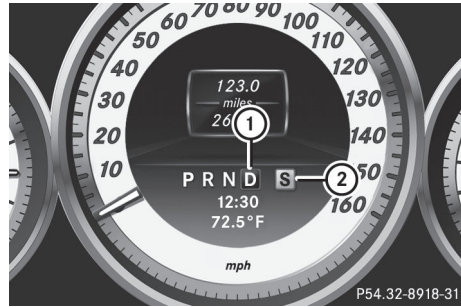

- ① Transmission position display
- ② Drive program display

The current position of the selector lever is shown by the indicators next to the selector lever.

The indicators light up when the SmartKey is inserted into the ignition lock. The indicators go out when the SmartKey is removed from the ignition lock.

## Transmission positions

### **P** Park position

Do not shift the transmission into position **P** (▷ page 140) unless the vehicle is stationary. The parking lock should not be used as a brake when parking. In addition to engaging the parking lock, you must always apply the parking brake to secure the vehicle.

The SmartKey can only be removed if the transmission is in position **P**. If the SmartKey is removed from the ignition lock, the selector lever is locked.

If the vehicle electronics are malfunctioning, the selector lever may be locked in position **P**. To release the selector lever lock, see "Releasing the parking lock manually" (▷ page 137).

### **R** Reverse gear

Only shift the transmission to **R** when the vehicle is stationary.

### **N** Neutral

Do not shift the transmission to **N** while driving. The transmission could otherwise be damaged.

No power is transmitted from the engine to the drive wheels.

Releasing the brakes will allow you to move the vehicle freely, e.g. to push it or tow it.

If ESP® is deactivated or faulty: only shift the transmission to position **N** if the vehicle is in danger of skidding, e.g. on icy roads.

**!** Rolling in neutral **N** can damage the drive train.

### **D** Drive

The automatic transmission changes gear automatically. All forward gears are available.

## Changing gear

The automatic transmission shifts to the individual gears automatically when it is in transmission position **D**. This automatic gearshifting behavior is determined by:

- a shift range restriction, if selected
- the selected drive program (▷ page 132)
- the position of the accelerator pedal
- the road speed

## Driving tips

### AMG vehicles

When shifting down, the double-clutch function is active regardless of the currently selected drive program. The double-clutch function reduces load change reactions and is conducive to a sporty driving style. The sound generated by the double-clutch function depends on the drive program selected.

### Kickdown

Use kickdown for maximum acceleration.

- **Vehicles for USA (except AMG vehicles):** fully depress the accelerator pedal.

The transmission shifts to a lower gear depending on the engine speed.

- **Vehicles for Canada and AMG vehicles:** depress the accelerator pedal beyond the pressure point.
- The transmission shifts to a lower gear depending on the engine speed.

### Working on the vehicle

#### WARNING

When working on the vehicle, engage the parking brake and shift the automatic transmission into park position **P**. Otherwise the vehicle could roll away which could result in an accident and/or serious personal injury.

### Program selector button

#### General information

The program selector button allows you to choose between different driving characteristics.

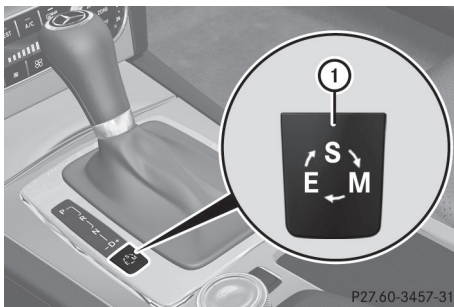

Example: program selector button

<b>E</b> Economy	Comfortable, economical driving
<b>S</b> Sport	Sporty driving style
<b>M</b> Manual	Manual gear shifting

- i** For further information on the automatic drive program, see (▶ page 133).

Only change from automatic drive program **E** or **S** to manual drive program **M** when the vehicle is stationary.

- Press program selector button ① repeatedly until the letter for the desired gearshift program appears in the multifunction display.

### AMG vehicles



Drive program selector with manual drive program

<b>C</b> Controlled Efficiency	Comfortable, economical driving
<b>S</b> Sport	Sporty driving style
<b>S+</b> SportPlus	Extremely sporty driving style
<b>M</b> Manual	Manual gear shifting
<b>RS RACE START</b>	Optimal vehicle acceleration from a standstill

- i** For further information on the automatic drive program, see (▶ page 133).



Only change from automatic drive program **C**, **S** or **S+** to manual drive program **M** when the vehicle is stationary.

▶ Turn drive program selector ① until the desired drive program appears in the multifunction display in the speedometer. The drive program indicator on drive program selector ① lights up in red.

- ❗ The automatic transmission shifts to automatic drive program **C** each time the engine is started.
- ❗ **RS** cannot be selected during normal driving. For further information on RACE START, see (▶ page 150).

### Steering wheel paddle shifters

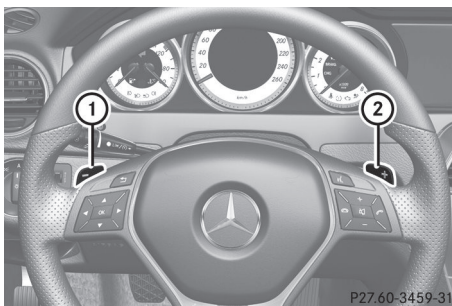

- ① Left-hand steering wheel paddle shifter
- ② Right-hand steering wheel paddle shifter

In the automatic drive program, you can restrict or derestrict the shift range by using the steering wheel paddle shifters (▶ page 133).

In the manual drive program, you can change gear using the steering wheel paddle shifters or the selector lever (▶ page 134).

- ❗ You can only change gear with the steering wheel paddle shifters when the transmission is in position **D**.

### Automatic drive program

Drive program **E** (drive program **C** on AMG vehicles) is characterized by the following:

- comfort-oriented engine and automatic transmission settings
- optimal fuel consumption resulting from the automatic transmission shifting up sooner
- the vehicle pulling away more gently in forward and reverse gears, unless the accelerator pedal is depressed fully
- increased sensitivity. This improves driving stability on slippery road surfaces, for example
- the automatic transmission shifting up sooner. This results in the vehicle being driven at lower engine speeds and the wheels being less likely to spin

Drive program **S** (drive programs **S** and **S+** on AMG vehicles) is characterized by the following:

- sporty engine and automatic transmission settings
- the vehicle pulling away in first gear
- the automatic transmission shifting up later
- the fuel consumption possibly being higher as a result of the later automatic transmission shift points

### Shift ranges

#### Introduction

When the automatic transmission is in position **D**, it is possible to restrict or derestrict the shift range (▶ page 133).

The shift range selected is shown in the multifunction display. The automatic transmission shifts only as far as the selected gear.

**Shift range**

<b>3</b>	You can use the engine's braking effect.
<b>2</b>	To use the braking effect of the engine on downhill gradients and for driving: <ul style="list-style-type: none"> <li>• on steep mountain roads</li> <li>• in mountainous terrain</li> <li>• in arduous conditions</li> </ul>
<b>1</b>	To use the braking effect of the engine on extremely steep downhill gradients and on long downhill stretches

**Restricting the shift range**

- ▶ Press the selector lever to the left towards **D-**.

or

- ▶ Pull the left-hand steering wheel paddle shifter.  
The automatic transmission shifts down one gear and restricts the shift range to the relevant gear.

- i** If the engine exceeds the maximum engine speed when shifting down, the automatic transmission protects against engine damage by not shifting down.
- i** If the maximum engine speed for the shift range is reached and you continue to accelerate, the automatic transmission shifts up in order to prevent the engine from overrevving, even if the shift range is restricted.

**Derestricting the shift range**

- ▶ Briefly press the selector lever to the right towards **D+**.

or

- ▶ Pull the right-hand steering wheel paddle shifter.  
The shift range is derestricted.

**Clearing the shift range restriction**

- ▶ Press and hold the selector lever towards **D+** until **D** is shown once more in the multifunction display.

or

- ▶ Pull and hold the right-hand steering wheel paddle shifter until **D** is shown again in the multifunction display.  
The automatic transmission shifts from the current shift range directly to **D**.

**Selecting the ideal shift range**

- ▶ Press the selector lever to the left towards **D-** and hold it in position.

or

- ▶ Pull the left-hand steering wheel paddle shifter and hold it in position.  
The automatic transmission shifts to the gear which allows optimum acceleration and deceleration. To do this, the automatic transmission shifts down one or more gears.

**Manual drive program****Switching on the manual drive program**

The manual drive program is only available for vehicles with the dynamic handling package and for AMG vehicles.

Manual drive program **M** is different from drive program **S** (in AMG vehicles, drive programs **S** and **S+**) with regard to spontaneity, responsiveness and smoothness of gear changes.

Manual drive program **M** can be selected using the drive program selector or the program selector button. You can change gears using the steering wheel paddle shifters or the selector lever in manual drive program **M** if the transmission is in position **D**.

- ▶ Press the program selector button (▷ page 132) repeatedly until **M** appears in the multifunction display.

- ▶ **AMG vehicles:** turn the drive program selector (▷ page 132) until **M** appears in the multifunction display. The indicator **M** on the drive program selector lights up in red.

### Upshifting

- i Vehicles with the dynamic handling package:** if the maximum engine speed for the shift range is reached and you continue to accelerate, the automatic transmission shifts up, except when manual drive program **M** is selected.

- ▶ Briefly press the selector lever to the right towards **D+**.

or

- ▶ Pull the right-hand steering wheel paddle shifter (▷ page 133). The automatic transmission shifts up to the next gear.

### Vehicles with AMG engines

- !** In manual drive program **M**, the automatic transmission does not shift up automatically even when the engine limiting speed for the current gear is reached. When the engine limiting speed is reached, the fuel supply is cut to prevent the engine from overrevving. Always make sure that the engine speed does not reach the red area of the tachometer. There is otherwise a risk of engine damage.

Before the engine speed reaches the red area, an upshift indicator appears in the multifunction display.

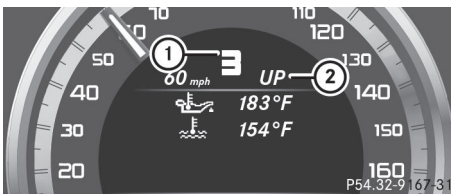

- ① Gear indicator
- ② Upshift indicator

### Downshifting

- ▶ Briefly press the selector lever to the left towards **D-**.

or

- ▶ Pull the left-hand steering wheel paddle shifter (▷ page 133). The automatic transmission shifts down to the next gear.

- i** If you brake the vehicle or stop without shifting down, the automatic transmission will shift down to a gear that will allow the vehicle to accelerate or pull away again.

- i Vehicles with the dynamic handling package:** to avoid overrevving the engine when downshifting, the automatic transmission does not shift to a lower gear if this would result in the maximum engine speed being exceeded.

- i** For maximum acceleration, push the selector lever to the left or pull and hold the left-hand steering wheel paddle shifter until the transmission shifts to the optimal gear for the current speed.

### Kickdown

- i Vehicles with an AMG engine:** it is not possible to use kickdown in manual drive program **M**.

You can also use kickdown for maximum acceleration in manual drive program **M**.

- ▶ **Vehicles for USA:** fully depress the accelerator pedal. The transmission shifts to a lower gear depending on the engine speed.
- ▶ **Vehicles for Canada:** depress the accelerator pedal beyond the pressure point. The transmission shifts to a lower gear depending on the engine speed.

- i** During kickdown, you cannot change gear using the steering wheel paddle shifters or the selector lever.

### Switching off the manual drive program

- ▶ **Vehicles with the dynamic handling package:** press the program selector button (▷ page 132). **M** is no longer shown in the multifunction display.
- ▶ **AMG vehicles:** turn the drive program selector (▷ page 132) until **C**, **S** or **S+** appears in the multifunction display.

### Problems with the transmission

Problem	Possible causes/consequences and ► Solutions
The transmission has problems shifting gear.	The transmission is losing oil. ► Have the transmission checked at a qualified specialist workshop immediately.
The acceleration ability is deteriorating. The transmission no longer changes gear.	The transmission is in emergency mode. It is only possible to shift into <b>second</b> gear and reverse gear. ► Stop the vehicle. ► Shift the transmission to position <b>P</b> . ► Switch off the engine. ► Wait at least 10 seconds before restarting the engine. ► Shift the transmission to position <b>D</b> or <b>R</b> . If <b>D</b> is selected, the transmission shifts into <b>second</b> gear; if <b>R</b> is selected, the transmission shifts into reverse gear. ► Have the transmission checked at a qualified specialist workshop immediately.

### Releasing the parking lock manually

In the event of an electrical malfunction, it is possible to release the selector lever lock manually to move it out of position **P**, e.g. if you wish to tow the vehicle away.

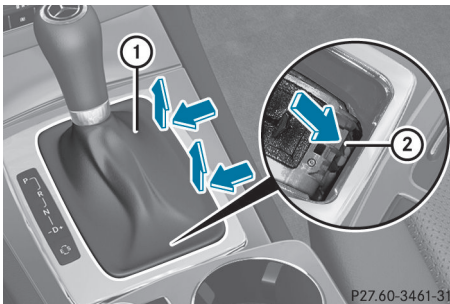

- ❗ Do not use any sharp-edged objects to remove the selector lever gaiter from the center console. This could damage the selector lever gaiter.
- Apply the parking brake.
  - Pry off selector lever gaiter ① with a flat, blunt object, (e.g. a screwdriver wrapped in

cloth) from the right-hand edge, pulling it up and out.

- Press release buttons ② down and simultaneously move the selector lever out of position **P**.  
The selector lever can now be moved freely until it is returned to position **P**.

### Refueling

#### Important safety notes

#### ⚠ WARNING

Gasoline is highly flammable and poisonous. It burns violently and can cause serious personal injury.

Never allow sparks, flames or smoking materials near gasoline.

Turn off the engine before refueling.

Whenever you are around gasoline, avoid inhaling fumes and any skin or clothing contact.

Direct skin contact with fuels and the inhalation of fuel vapors are damaging to your health.

#### WARNING

Overfilling of the fuel tank may create pressure in the system which could cause a gas discharge. This could cause the gasoline to spray back out when removing the fuel pump nozzle, which could cause personal injury.

**!** Do not use diesel to refuel vehicles with a gasoline engine. Even small amounts of the wrong fuel result in damage to the fuel system and engine.

**!** Do not switch on the ignition if you accidentally refuel with the wrong fuel. Otherwise, the fuel will enter the fuel lines. Notify a qualified specialist workshop and have the fuel tank and fuel lines drained completely.

**!** Overfilling the fuel tank could damage the fuel system.

**!** Take care not to spill any fuel on painted surfaces. You could otherwise damage the paintwork.

**!** Use a filter when refueling from a fuel can. Otherwise, the fuel lines and/or injection system could be blocked by particles from the fuel can.

Further information on fuel and on fuel grades can be found in the "Fuel" section (▷ page 309).

## Refueling

### Fuel filler flap

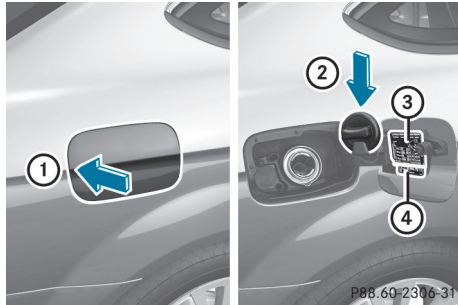

- ① To open the fuel filler flap
- ② To insert the fuel filler cap
- ③ Tire pressure table
- ④ Fuel type

The fuel filler flap is unlocked or locked automatically when you open or close the vehicle with the SmartKey or with KEYLESS-GO.

The position of the fuel filler cap  is displayed in the instrument cluster. The arrow next to the filling pump indicates the side of the vehicle.



### Opening

- ▶ Switch off the engine.
- ▶ Remove the SmartKey from the ignition lock.
- ▶ KEYLESS-GO: open the driver's door. This corresponds to SmartKey position **0**: "SmartKey removed".  
The driver's door can be closed again.
- ▶ Press the fuel filler flap in the direction of arrow ①.  
The fuel filler flap opens slightly.
- ▶ Open the fuel filler flap fully.
- ▶ Turn the fuel filler flap counter-clockwise and remove it.
- ▶ Insert the fuel filler cap into the holder bracket on the inside of filler flap ②.

- ▶ Completely insert the filler neck of the fuel pump nozzle into the tank and refuel.
- ▶ Only fill the tank until the pump nozzle switches off.
- i** Do not add any more fuel after the pump stops filling for the first time. Otherwise, fuel may leak out.

### Closing

---

- ▶ Replace the cap on the filler neck and turn clockwise until it engages audibly.
- ▶ Close the fuel filler flap.
- i** If you drive with the fuel filler cap open, reserve fuel warning lamp  flashes. In addition, the  Check Engine warning lamp may light up. A message appears in the multifunction display (> page 201).  
For further information on warning and indicator lamps in the instrument cluster, see (> page 217).
- i** Close the fuel filler flap before locking the vehicle. Otherwise, the locking pin of the central locking prevents the fuel filler flap from closing.



### Problems with fuel and the fuel tank

Problem	Possible causes/consequences and ► Solutions
Fuel is leaking from the vehicle.	<p> <b>Risk of explosion or fire</b></p> <p>The fuel line or the fuel tank is defective.</p> <ul style="list-style-type: none"> <li>► Turn the SmartKey to position <b>0</b> in the ignition lock immediately and remove it (▷ page 125).</li> <li>► Do not restart the engine under any circumstances.</li> <li>► Consult a qualified specialist workshop.</li> </ul>
The fuel filler flap cannot be opened.	<p>The fuel filler flap is not unlocked.</p> <p>or</p> <p>The SmartKey battery is discharged.</p> <ul style="list-style-type: none"> <li>► Unlock the vehicle using the mechanical key (▷ page 68).</li> </ul>
	<p>The fuel filler flap is unlocked, but the opening mechanism is jammed.</p> <ul style="list-style-type: none"> <li>► Consult a qualified specialist workshop.</li> </ul>

### Parking

#### Important safety notes

#### **WARNING**

Do not park this vehicle in areas where combustible materials can come into contact with the hot exhaust system. Do not park the vehicle on dry grassland or harvested grain fields. Combustible materials, such as grass, hay or leaves could be ignited by the hot exhaust system and cause a vehicle fire.

Unintended vehicle movement can cause serious personal injury or damage to the vehicle or the vehicle drivetrain. To reduce such risks, always do the following before turning off the engine and leaving the vehicle:

- keep your right foot on the brake pedal.
- engage the parking brake.
- shift the automatic transmission to park position **P**.
- slowly release the brake pedal.
- when parked on an incline, always turn the front wheels towards the road curb.

- turn the SmartKey in the ignition lock to position **0** and remove the SmartKey from the ignition lock, or press the KEYLESS-GO Start/Stop button.
- take the SmartKey with you and lock the vehicle when leaving.

### Switching off the engine

#### Important safety notes

#### **WARNING**

Do not turn off the engine before the vehicle has come to a complete stop. With the engine not running, there is no power assistance for the brake and steering systems. In this case, it is important to keep in mind that a considerably higher degree of effort is necessary to brake and steer the vehicle.

#### Vehicles with automatic transmission

- Apply the parking brake firmly.
- Shift the transmission to position **P**.

### Using the SmartKey

- ▶ Turn the SmartKey to position **0** in the ignition lock and remove it. The immobilizer is activated.
- i** The SmartKey can only be removed if the transmission is in position **P**.

### Using KEYLESS-GO

- ▶ Press the Start/Stop button (▷ page 125). The engine stops and all the indicator lamps in the instrument cluster go out.
- i** When the driver's door is closed, this corresponds to SmartKey position **1**. When the driver's door is open, it corresponds to SmartKey position **0** or "SmartKey removed".

If you attempt to switch off the engine while the selector lever is in a position other than **P**, a message appears in the multifunction display and you hear a tone.

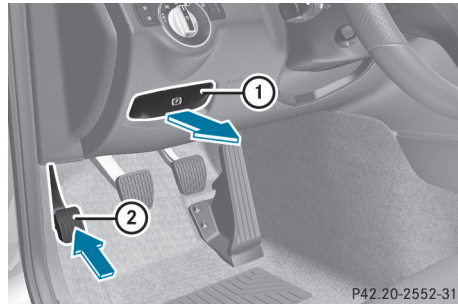

- ▶ **To apply:** depress parking brake **2** firmly. When the engine is running, the **BRAKE** (USA only) or **(P)** (Canada only) indicator lamp lights up in the instrument cluster.
- ▶ **To release:** depress the brake pedal and keep it depressed.
- ▶ Pull release handle **1**. When the ignition is switched on or the engine is running, the **BRAKE** (USA only) or **(P)** (Canada only) indicator lamp goes out in the instrument cluster.

### Parking brake

#### **⚠ WARNING**

Engaging the parking brake while the vehicle is in motion can cause the rear wheels to lock up. You could lose control of the vehicle and cause an accident. In addition, the vehicle's brake lights do not light up when the parking brake is engaged.

#### **⚠ WARNING**

When leaving the vehicle, always remove the SmartKey from the starter switch, take it with you, and lock the vehicle. Do not leave children unattended in the vehicle, or with access to an unlocked vehicle. Children could release the parking brake and/or shift the automatic transmission out of park position **P**, either of which could result in an accident and/or serious personal injury.

### Parking the vehicle for a long period

If you leave the vehicle parked for longer than four weeks, the battery may be damaged by exhaustive discharge.

- ▶ Connect a trickle charger.
  - i** You can obtain information about trickle chargers from a qualified specialist workshop.
- If you leave the vehicle parked for longer than six weeks, the vehicle may suffer damage as a result of lack of use.
- ▶ Visit a qualified specialist workshop and seek advice.

## Driving tips

### General driving tips

#### Important safety notes

##### WARNING

Always remember that you must concentrate primarily on driving the vehicle. The driver's concentration must always be directed primarily at road traffic. For your own safety and that of others, we recommend that you stop the vehicle at a safe place and in accordance with the traffic conditions before making or accepting a phone call.

Comply with all legal requirements if you use the telephone while driving. Use the hands-free system and only use the telephone when road, weather and traffic conditions permit. In some jurisdictions, it is forbidden for drivers to use mobile phones while driving.

Only operate the audio system or COMAND (Cockpit Management and Data System) in compliance with all legal requirements and when the road, weather and traffic conditions permit. You may otherwise not be able to observe the traffic conditions, endangering yourself and others.

Remember that your vehicle covers a distance of 44 ft (approximately 14 m) a second when it is traveling at only 30 mph (approximately 50 km/h).

#### Drive sensibly – save fuel

Observe the following tips to save fuel:

- ▶ The tires should always be inflated to the recommended tire pressure.
- ▶ Remove unnecessary loads.
- ▶ Remove roof racks when they are not needed.
- ▶ Warm up the engine at low engine speeds.
- ▶ Avoid frequent acceleration or braking.
- ▶ Have all maintenance work carried out as indicated by the service intervals in the Maintenance Booklet or by the service interval display.

Fuel consumption also increases when driving in cold weather, in stop-and-go traffic and in mountainous terrain.

#### Drinking and driving

##### WARNING

Drinking and driving and/or taking drugs and driving are very dangerous combinations. Even a small amount of alcohol or drugs can affect your reflexes, perceptions and judgment.

The possibility of a serious or even fatal accident are greatly increased when you drink or take drugs and drive.

Do not drink or take drugs and drive or allow anyone to drive who has been drinking or taking drugs.

#### Pedals

##### WARNING

Make sure absolutely no objects are obstructing the pedals' range of movement. Keep the driver's footwell clear of all obstacles. If there are any floor mats or carpets in the footwell, make sure that the pedals still have sufficient clearance.

During sudden driving or braking maneuvers, the objects could get caught between the pedals. You could then no longer brake or accelerate. This could lead to accidents and injury.

#### Rolling with the engine switched off

##### WARNING

There is no power assistance for the steering and the brake when the engine is not running. Steering and braking requires significantly more effort and you could lose control of the vehicle and cause an accident as a result.

Do not turn off the engine while the vehicle is in motion.

## Exhaust check

### WARNING

Inhalation of exhaust gas is hazardous to your health. All exhaust gas contains carbon monoxide (CO), and inhaling it can cause unconsciousness and possible death.

Do not run the engine in confined areas (such as a garage) which are not properly ventilated. If you think that exhaust gas fumes are entering the vehicle while driving, have the cause determined and corrected immediately. If you must drive under these conditions, drive only with at least one window fully open at all times.

Certain engine systems are designed to keep the level of poisonous components in exhaust fumes within legal limits.

These systems only work at peak efficiency if they are serviced exactly in accordance with the manufacturer's specifications. For this reason, all work on the engine should only be carried out by qualified and authorized Mercedes-Benz technicians.

The engine settings must not be changed under any circumstances. Furthermore, all specific service work must be carried out at regular intervals and in accordance with the Mercedes-Benz service requirements. Details can be found in the Maintenance Booklet.

## Brakes

### Important safety notes

#### WARNING

On slippery road surfaces, never downshift in order to obtain braking action. This could result in drive wheel slip and reduced vehicle control. Your vehicle's ABS will not prevent this type of loss of control.

#### WARNING

Make sure that you do not endanger other road users when you apply the brakes.

## Downhill gradients

 On long and steep gradients, you must reduce the load on the brakes by shifting early to a lower gear. This allows you to take advantage of the engine braking effect and helps avoid overheating and excessive wear of the brakes.

When you take advantage of the engine braking effect, a drive wheel may not turn for some time, e.g. on a slippery road surface. This could cause damage to the drive train. This type of damage is not covered by the Mercedes-Benz warranty.

## Heavy and light loads

### WARNING

Depressing the brake pedal constantly results in excessive and premature wear to the brake pads.

It may also cause the brakes to overheat, seriously impairing their effectiveness. It may then not be possible to stop the vehicle in sufficient time to avoid an accident.

If the brakes have been subjected to a heavy load, do not stop the vehicle immediately, but drive on for a short while. This allows the airflow to cool the brakes more quickly.

## Wet roads

### WARNING

After driving in heavy rain for some time without applying the brakes or through water deep enough to wet brake components, the first braking action may be somewhat reduced. You have to depress the brake pedal more firmly. Maintain a safe distance from vehicles in front.

After driving on a wet road or having the vehicle washed, brake firmly while paying attention to the traffic conditions. This will warm up the brake discs, thereby drying them more quickly and protecting them against corrosion.

### Limited braking performance on salt-treated roads

#### WARNING

The layer of salt on the brake discs and the brake pads/linings may cause a delay in the braking effect, resulting in a significantly longer braking distance, which could lead to an accident.

To avoid this danger, you should:

- occasionally brake carefully, without putting other road users at risk, when you are driving on salted roads. This helps to remove any salt that may have started to build up on the brake discs and the brake pads/linings.
- maintain a greater distance to the vehicle ahead and drive with particular care.
- carefully apply the brakes at the end of a trip and immediately after commencing a new trip, so that salt residues are removed from the brake discs.

### Servicing the brakes

 If the red brake warning lamp lights up in the instrument cluster and you hear a warning tone while the engine is running, the brake fluid level may be too low. Observe additional warning messages in the multifunction display.

The brake fluid level may be too low due to brake pad wear or leaking brake lines.

Have the brake system checked immediately. This work should be carried out at a qualified specialist workshop.

All checks and maintenance work on the brake system must be carried out at a qualified specialist workshop. Consult a qualified specialist workshop to arrange this. Have brake pads installed and brake fluid replaced at a qualified specialist workshop.

#### WARNING

If brake pads or brake fluid other than those recommended are used, the braking

properties of the vehicle can be degraded to an extent that safe braking is substantially impaired. This could result in an accident.

 **Vehicles with 4MATIC:** function or performance tests may only be carried out on a 2-axle dynamometer. If you are planning to have the vehicle tested on such a dynamometer, contact an authorized Mercedes-Benz Center to obtain further information first. Otherwise, you could damage the drive train or the brake system.

 **Vehicles with 4MATIC:** as the ESP<sup>®</sup> system operates automatically, the engine and the ignition must be switched off (SmartKey in position **0** or **1** in the ignition lock or Start/Stop button in position **0** or **1**) while the parking brake is being tested on a brake dynamometer.

Braking maneuvers triggered automatically by ESP<sup>®</sup> may seriously damage the brake system.

 **Vehicles with 4MATIC:** as the ESP<sup>®</sup> system operates automatically, the engine and the ignition system must be switched off (SmartKey in position **0** or **1** in the ignition lock or Start/Stop button in position **0** or **1**) when:

- testing the parking brake on a brake dynamometer.
- you intend to have the vehicle towed with the front axle raised.

Braking maneuvers triggered automatically by ESP<sup>®</sup> may seriously damage the brake system.

If the brake system has only been subject to moderate loads, you should test the functionality of your brakes at regular intervals. To do so, press firmly on the brake pedal when driving at a high speed. This improves the grip of the brake pads.

#### WARNING

Make sure that you do not endanger other road users when you apply the brakes.

You can find a description of Brake Assist (BAS) on (▷ page 59).

### High-performance brake system for AMG vehicles

The high-performance brake system is installed only on the C 63 AMG.

#### WARNING

New vehicle brake pads and discs, and replacement brake pads and discs may take several hundred miles of driving until they provide optimum braking efficiency. Until that time, you may need to use increased brake pedal pressure while braking. Please be aware of this and adjust your driving and braking accordingly during this break-in period.

Excessive high-demand braking will cause correspondingly high brake wear. Please be attentive to the brake warning lamp in the instrument cluster and brake condition messages in the multifunction display. Especially for high performance driving, it is important to maintain and have the brake system checked regularly.

The high-performance brake system is designed for heavy loads. This may lead to noise when braking. This will depend on:

- speed
- braking force
- environmental conditions, such as temperature and humidity

The wear of individual components of the brake system, such as the brake pads/linings or brake discs, depends on the individual driving style and operating conditions.

For this reason, it is impossible to state a mileage that will be valid under all circumstances. An aggressive driving style will lead to high wear. You can obtain further information about this from your authorized Mercedes-Benz Center.

### Driving on wet roads

#### Hydroplaning

If water has accumulated to a certain depth on the road surface, there is a danger of hydroplaning occurring, even if:

- you drive at low speeds.
- the tires have adequate tread depth.

For this reason, in the event of heavy rain or in conditions in which hydroplaning can occur, you must drive in the following manner:

- lower your speed.
- avoid ruts.
- brake carefully.

#### Driving on flooded roads

- ❗ Do not drive through flooded areas. Check the depth of any water before driving through it. Drive slowly through standing water. Otherwise, water may enter the vehicle interior or the engine compartment. This can damage the electronic components in the engine or the automatic transmission. Water can also be drawn in by the engine's air suction nozzles and this can cause engine damage.

### Winter driving

#### Important safety notes

#### WARNING

If the vehicle becomes trapped in snow, ensure that snow is kept away from the exhaust pipe and from around the vehicle as long as the engine is running. Otherwise, poisonous carbon monoxide (CO) may enter the vehicle, resulting in loss of consciousness and even death.

To assure sufficient fresh air ventilation, open a window slightly on the side of the vehicle not facing the wind.

Have your vehicle winterproofed at a qualified specialist workshop at the onset of winter. Observe the notes in the "Winter operation" section (▷ page 278).

### Driving with summer tires

Observe the notes in the "Winter operation" section (▷ page 278).

### Slippery road surfaces

#### WARNING

The outside temperature indicator is not designed to serve as an ice-warning device and is therefore unsuitable for that purpose.

Indicated temperatures just above the freezing point do not guarantee that the road surface is free of ice. The road may still be icy, especially in wooded areas or on bridges.

#### WARNING

On slippery road surfaces, never downshift in order to obtain braking action. This could result in drive wheel slip and reduced vehicle control. Your vehicle's ABS will not prevent this type of loss of control.

Drive particularly carefully on slippery road surfaces. Avoid sudden acceleration, steering and braking maneuvers. Do not use cruise control.

If the vehicle threatens to skid or cannot be stopped when moving at low speed:

- ▶ Shift the transmission to position **N**.

-  For more information on driving with snow chains, see (▷ page 279).

#### WARNING

Make sure that you do not endanger other road users when you apply the brakes.

## Driving systems

### Cruise control

#### Important safety notes

Cruise control maintains a constant road speed for you. It brakes automatically in order to avoid exceeding the set speed. On long and steep downhill gradients, especially if the vehicle is laden, you must select shift range **1, 2 or 3** in good time. By doing so, you will make use of the braking effect of the engine, which relieves the load on the brake system and prevents the brakes from overheating and wearing too quickly.

Use cruise control only if road and traffic conditions make it appropriate to maintain a steady speed for a prolonged period. You can store any road speed above 20 mph (30 km/h).

#### WARNING

The cruise control is a convenience system designed to assist the driver during vehicle operation. The driver is and must always remain responsible for the vehicle's speed and for safe brake operation.

Only use the cruise control if the road, traffic, and weather conditions make it advisable to travel at a constant speed.

- The use of the cruise control can be dangerous on winding roads or in heavy traffic because conditions do not allow safe driving at a constant speed.
- The use of the cruise control can be dangerous on slippery roads. Rapid changes in tire traction can result in wheel spin and loss of control.
- Deactivate the cruise control when driving in fog.

The "Resume" function should only be operated if the driver is fully aware of the previously set speed and wishes to resume this particular preset speed.



**⚠ WARNING**

The cruise control brakes automatically so that the set speed is not exceeded.

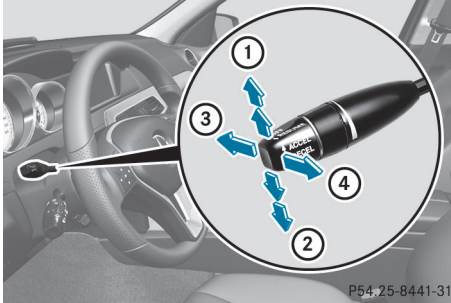
**Cruise control lever**

- ① To activate or increase speed
- ② To activate or reduce speed
- ③ To deactivate cruise control
- ④ To activate at the current speed/last stored speed

When you activate cruise control, the stored speed is shown in the multifunction display for five seconds. In the multifunction display, the segments between the stored speed and the maximum speed light up.

**Storing and maintaining the current speed**

You can store the current speed if you are driving faster than 20 mph (30 km/h).

- ▶ Accelerate the vehicle to the desired speed.
- ▶ Briefly press the cruise control lever up ① or down ②.
- ▶ Remove your foot from the accelerator pedal.  
Cruise control is activated. The vehicle automatically maintains the stored speed.

**i** Cruise control may be unable to maintain the stored speed on uphill gradients. The stored speed is resumed when the gradient evens out. Cruise control maintains the

stored speed on downhill gradients by automatically applying the brakes.

**Storing the current speed or calling up the last stored speed****⚠ WARNING**

The set speed stored in memory should only be set again if prevailing road conditions and legal speed limits permit. Possible acceleration or deceleration differences arising from returning to the preset speed could cause an accident and/or serious injury to you and others.

- ▶ Briefly pull the cruise control lever towards you ④.
- ▶ Remove your foot from the accelerator pedal.  
The first time cruise control is activated, it stores the current speed or regulates the speed of the vehicle to the previously stored speed.

**Setting a speed****⚠ WARNING**

Keep in mind that it may take a brief moment until the vehicle has made the necessary adjustments.

Increase or decrease the set vehicle speed to a value that the prevailing road conditions and legal speed limits permit. Otherwise, sudden and unexpected acceleration or deceleration of the vehicle could cause an accident and/or serious injury to you and others.

- ▶ Press the cruise control lever up ① for a higher speed or down ② for a lower speed.
- ▶ **To adjust the speed in 1 mph increments (1 km/h increments):** briefly

press the cruise control lever up ① or down ② to the pressure point.

The last speed stored is increased or decreased every time the cruise control lever is pushed up ① or down ②.

- ▶ **To adjust the speed in 5 mph increments (10 km/h increments):** briefly press the cruise control lever up ① or down ② beyond the pressure point.

The last speed stored is increased or decreased every time the cruise control lever is pushed up ① or down ②.

- ❗ Cruise control is not deactivated if you depress the accelerator pedal. For example, if you accelerate briefly to overtake, cruise control adjusts the vehicle's speed to the last speed stored after you have finished overtaking.

### Deactivating cruise control

There are several ways to deactivate cruise control:

- ▶ Briefly press the cruise control lever forwards ③.

or

- ▶ Brake.

Cruise control is automatically deactivated if:

- you depress the parking brake.
- you are driving at less than 20 mph (30 km/h)
- ESP® intervenes or you deactivate ESP®.
- you shift the transmission to position **N** while driving.

If cruise control is deactivated, you will hear a warning tone. You will see the **Cruise Control Off** message in the multifunction display for approximately five seconds.

- ❗ When you switch off the engine, the last speed stored is cleared.

## Dynamic handling package with sports mode

### General notes

The most important part of the dynamic handling package with sports mode is the adjustable damping system. This automatically controls and adapts the suspension to the respective driving situation.

The calibration of the suspension depends on:

- your driving style
- the road surface conditions
- your individual selection; see the following description

The dynamic handling package with sports mode also includes steering wheel paddle shifters (▷ page 133) with a manual drive program (▷ page 134).



Example: position of dynamic handling package with sports mode button

- ▶ Start the engine.

### Sports tuning

The firmer setting of the suspension tuning in sports mode ensures even better contact with the road. Select this mode when employing a sporty driving style, e.g. on winding country roads.

Your selection remains stored until you switch off the engine.

- ▶ Press button ②.  
Indicator lamp ① lights up. Sports suspension tuning is selected. Depending on the engine output, the accelerator pedal is more responsive. On vehicles with automatic transmission, drive program **S** is selected.

### Comfort tuning

In Comfort mode, the driving characteristics of your vehicle are more comfortable. Therefore, select this mode if you favor a more comfortable driving style. Select comfort mode also when driving fast on straight roads, e.g. on straight stretches of freeway.

- ▶ Press button ②.  
Indicator lamp ① goes out. Comfortable suspension tuning is selected. On vehicles with automatic transmission, drive program **E** is selected.

### HOLD function

#### General notes

The HOLD function can assist the driver in the following situations:

- when pulling away, especially on steep slopes
- when maneuvering on steep slopes
- when waiting in traffic

The vehicle is kept stationary without the driver having to depress the brake pedal. The braking effect is canceled and the HOLD function deactivated when you depress the accelerator pedal to pull away.

#### Activation conditions

You can activate the HOLD function if:

- the vehicle is stationary.
- the engine is running.

- the driver's door is closed or your seat belt is fastened.
- the parking brake is released.
- the hood is closed.
- the transmission is in position **D**, **R** or **N**.

#### Activating the HOLD function

- ▶ Make sure that the activation conditions are met.
- ▶ Depress the brake pedal.
- ▶ Quickly depress the brake pedal further until **HOLD** appears in the multifunction display.  
The HOLD function is activated. You can release the brake pedal.

- ❗ If depressing the brake pedal the first time does not activate the HOLD function, wait briefly and then try again.

#### WARNING

The vehicle's brakes are applied when the HOLD function is activated. For this reason, deactivate the HOLD function if the vehicle is to be set in motion by other means (e.g. in a car wash or by towing).

#### Deactivating the HOLD function

The HOLD function is deactivated automatically if:

- you accelerate and the transmission is in position **D** or **R**.
- you depress the brake pedal again with a certain amount of pressure until **HOLD** disappears from the multifunction display.
- you shift the transmission to position **P**.

#### WARNING

Never get out of the vehicle when the HOLD function is activated.

The HOLD function must never be operated or deactivated by a passenger or from outside the vehicle.

The HOLD function does not replace the parking brake and must not be used for parking.

The braking effect of the HOLD function is canceled and the vehicle could roll away if:

- the HOLD function is deactivated by depressing the accelerator pedal or the brake pedal.
- there is a malfunction in the system or an interruption in the power supply, e.g. battery failure.
- the electrical system in the engine compartment, the battery or the fuses are tampered with.
- the battery is disconnected.

If you leave the vehicle or park it, deactivate the HOLD function and secure the vehicle against rolling away.

You will see a warning message in the multifunction display if the HOLD function is activated and:

- the driver's door is open and the driver's seat belt is unfastened.
  - the engine is switched off.
  - the hood is opened.
- Shift the transmission to position **P** to prevent the vehicle from rolling away. The HOLD function is deactivated. The warning message in the multifunction display disappears.

A horn will also sound at regular intervals if the HOLD function is activated and you:

- switch the engine off, open the driver's door and remove your seat belt
- open the hood

The sounding of the horn alerts you to the fact that the vehicle has been parked while the HOLD function is still activated. If you attempt to lock the vehicle, the tone becomes louder. The vehicle is not locked until the HOLD function is deactivated.

- ❗ If the engine has been switched off, it can't be started again until the HOLD function has been deactivated.

If there is a malfunction in the system or power supply while the HOLD function is activated, the **Brake Immediately** message is shown in the multifunction display. Immediately depress the brake firmly until the warning message in the multifunction display goes out.

You can also shift the transmission to position **P**. This deactivates the HOLD function.

## RACE START

### Important safety notes

- ❗ RACE START is only available in AMG vehicles.

RACE START enables optimal acceleration from a standing start. The precondition for this is a suitable high-grip road surface.

### WARNING

RACE START is only available when SPORT handling mode is activated. SPORT handling mode only stabilizes the vehicle to a limited extent in the event of swerving or wheelspin. RACE START should only be used on specially designated roads. Always adapt your speed and driving style to the prevailing road and weather conditions.

### Conditions for activation

RACE START can be activated when:

- the doors are closed.
- the engine is running and it has reached an operating temperature of approximately 176 °F (80 °C). This is the case when the engine oil temperature in the multifunction display stops flashing.
- SPORT handling mode is activated. (► page 61)
- the steering wheel is in the straight-ahead position.

- the vehicle is stationary and the brake pedal is depressed (left foot).
- the transmission is in position **D**.

### Activating RACE START

- ▶ Depress the brake pedal with your left foot, and keep it depressed.
- ▶ Turn the drive program selector clockwise (> page 132) until the **RS** lamp lights up. The multifunction display shows the **RACE START Confirm: Paddle UP Cancel: Paddle DOWN** message.

**i** If the activation conditions are no longer fulfilled, RACE START is canceled. The multifunction display shows the **RACE START Canceled** message.

- ▶ To cancel: pull the left steering wheel shift paddle (> page 133).

or

- ▶ To confirm: pull the right steering wheel shift paddle (> page 133). The multifunction display shows the **RACE START Available Depress gas pedal** message.

**i** If you do not depress the accelerator pedal fully within two seconds, RACE START is canceled. The multifunction display shows the **RACE START Not Possible See Operator's Manual** message.

- ▶ Depress the accelerator pedal fully. The engine speed increases to approximately 3500 rpm. The multifunction display shows the **RACE START Release brake to start** message.

**i** If you do not release the brake pedal within five seconds, RACE START is canceled. The multifunction display shows the **RACE START Canceled** message.

- ▶ Take your foot off the brake, but keep the accelerator pedal depressed. The vehicle pulls away at maximum acceleration.

The multifunction display shows the **RACE START Active** message.

RACE START is deactivated when the vehicle reaches a speed of approximately 30 mph (Canada: 50 km/h). Drive program **S+** is activated. SPORT handling mode remains activated.

RACE START is deactivated immediately if you release the accelerator pedal during RACE START or if any of the activation conditions are no longer fulfilled. The multifunction display shows the **RACE START Not Possible See Operator's Manual** message.

**i** If RACE START is used repeatedly within a short period of time, it is only available again after the vehicle has been driven a certain distance.

### 4MATIC (permanent four-wheel drive)

4MATIC ensures that all four wheels are permanently driven. Together with ESP<sup>®</sup>, it improves the traction of your vehicle whenever a drive wheel spins due to insufficient grip.

#### WARNING

If a drive wheel is spinning due to insufficient traction:

- While driving off, apply as little throttle as possible.
- While driving, ease up on the accelerator pedal.
- Adapt your speed and driving style to the prevailing road conditions.

Failure to observe these guidelines could cause the vehicle to skid.

4MATIC cannot prevent accidents resulting from excessive speed.

**!** Never tow the vehicle with one axle raised. This may damage the transfer case. Damage of this sort is not covered by the Mercedes-Benz Limited Warranty. All

wheels must remain either on the ground or be fully raised. Observe the instructions for towing the vehicle with all wheels in full contact with the ground.

- i** In wintry driving conditions, the maximum effect of 4MATIC can only be achieved if you use winter tires (M+S tires), with snow chains if necessary.

## PARKTRONIC

### Important safety notes

#### **⚠ WARNING**

The PARKTRONIC is a supplemental system. It is not intended to, nor does it replace, the need for extreme care. The responsibility during parking and other critical maneuvers always remains with the driver.

#### **⚠ WARNING**

Make sure no persons or animals are in or near the area in which you are parking/ maneuvering. Otherwise, they could be injured.

PARKTRONIC is an electronic parking aid with ultrasonic sensors. It indicates visually and audibly the distance between your vehicle and an object.

PARKTRONIC is activated automatically when you:

- switch on the ignition
- shift the transmission to position **D**, **R** or **N**
- release the parking brake

PARKTRONIC is deactivated at speeds above 11 mph (18km/h). It is reactivated at lower speeds.

PARKTRONIC monitors the area around your vehicle using six sensors in the front and four sensors in the rear.

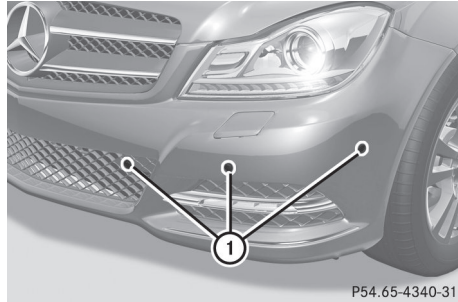

P54.65-4340-31

- ① Example: sensors in the front bumper, left-hand side

### Range of the sensors

#### General notes

The sensors must be free of dirt, ice and slush. Otherwise, they may not function correctly. Clean the sensors regularly, taking care not to scratch or damage them (▷ page 255).

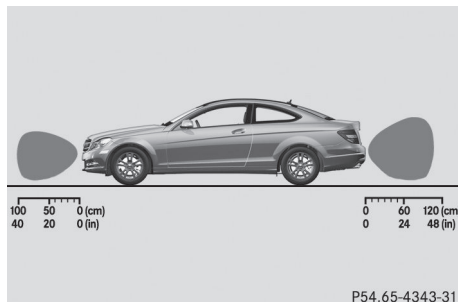

P54.65-4343-31

Side view

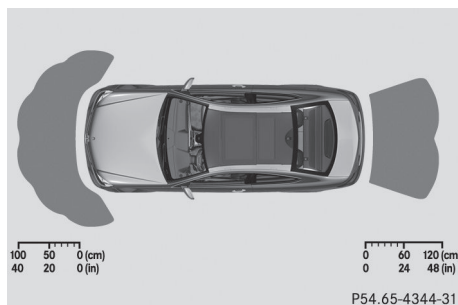

P54.65-4344-31

Top view

**Front sensors**

Center	approximately 40in (approximately 100cm)
Corners	approximately 24in (approximately 60cm)

**Rear sensors**

Center	approximately 48in (approximately 120cm)
Corners	approximately 32in (approximately 80cm)

**!** When parking, pay particular attention to objects above or below the sensors, such as flower pots or trailer drawbars. PARKTRONIC does not detect such objects when they are in the immediate vicinity of the vehicle. You could damage the vehicle or the objects.

The sensors may not detect snow and other objects that absorb ultrasonic waves.

Ultrasonic sources such as an automatic car wash, the compressed-air brakes on a truck or a pneumatic drill could cause PARKTRONIC to malfunction.

PARKTRONIC may not function correctly on uneven terrain.

**Minimum distance**

Center	approximately 8in (approximately 20cm)
Corners	approximately 6in (approximately 15cm)

If there is an obstacle within this range, the relevant warning displays light up and a warning tone sounds. If the distance falls below the minimum, the distance may no longer be shown.

**Warning displays**

The warning displays show the distance between the sensors and the obstacle. The warning display for the front area is located on the dashboard above the center air vents. The warning display for the rear area is located on the headliner in the rear compartment.

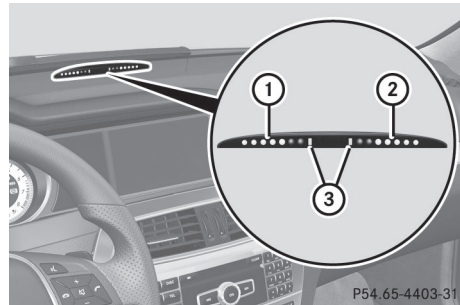

Warning display for the front area

- ① Segments on the left-hand side of the vehicle
- ② Segments on the right-hand side of the vehicle
- ③ Segments showing operational readiness

The warning display for each side of the vehicle is divided into five yellow and two red segments. PARKTRONIC is operational if yellow segments showing operational readiness ③ light up.

The selected transmission position and the direction in which the vehicle is rolling determine which warning display is active when the engine is running.

Transmission position	Warning display
D	Front area activated
R, N or the vehicle is rolling backwards	Rear and front areas activated
P	No areas activated



One or more segments light up as the vehicle approaches an obstacle, depending on the vehicle's distance from the obstacle.

From the:

- sixth segment onwards, you will hear an intermittent warning tone for approximately two seconds.
- seventh segment onwards, you will hear a warning tone for approximately two seconds. This indicates that you have now reached the minimum distance.

### Deactivating/activating PARKTRONIC

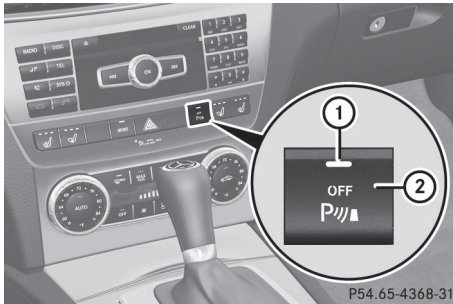

- ① Indicator lamp
- ② To deactivate/activate PARKTRONIC

If indicator lamp ① lights up, PARKTRONIC is deactivated. Parking Guidance is also deactivated.

- i** PARKTRONIC is automatically activated when you turn the SmartKey to position 2 in the ignition lock.

## Problems with PARKTRONIC

Problem	Possible causes/consequences and ► Solutions
Only the red segments in the PARKTRONIC warning displays are lit. You also hear a warning tone for approximately two seconds. PARKTRONIC is deactivated after approximately 20 seconds, and the indicator lamp in the PARKTRONIC button lights up.	<p>PARKTRONIC has malfunctioned and has switched off.</p> <p>► If problems persist, have PARKTRONIC checked at a qualified specialist workshop.</p>
Only the red segments in the PARKTRONIC warning displays are lit. PARKTRONIC is deactivated after approximately 20 seconds.	<p>The PARKTRONIC sensors are dirty or there is interference.</p> <p>► Clean the PARKTRONIC sensors (▷ page 255).</p> <p>► Switch the ignition back on.</p> <p>The problem may be caused by an external source of radio or ultrasound waves.</p> <p>► See if PARKTRONIC functions in a different location.</p>

### Parking Guidance

#### Important safety notes

- i** Parking Guidance is only available in Canada.

Parking Guidance is an electronic parking aid with ultrasound. Ultrasound is used to measure the road on both sides of the vehicle. A suitable parking space is indicated by the parking symbol. You receive steering instructions when parking. You may also use PARKTRONIC (▷ page 152).

#### WARNING

Parking Guidance is merely an aid and may display parking spaces that are not suitable for parking, for example:

- no-parking areas
- parking spaces with unsuitable surfaces (road surface)
- driveways
- entrances and exits

Parking Guidance detects and measures potential parking spaces while driving past. Changes to the parking space after this point are not taken into account, for example if the vehicle in front of or behind the parking space changes position or objects in the parking space are moved.

Even when using Parking Guidance, you are still responsible for driving carefully. If you rely on Parking Guidance alone, you could

cause an accident and injure yourself and others.

Safety always remains your responsibility and you must continue paying careful attention to your immediate surroundings when parking and maneuvering.

#### WARNING

Objects located above the height range of Parking Guidance will not be detected when the parking space is measured. These objects are not taken into account when the parking procedure is calculated, e.g. overhanging loads, tail sections or loading ramps of goods vehicles. Under some circumstances, Parking Guidance might therefore issue steering instructions too soon. This may lead to a collision. For this reason, you should avoid using Parking Guidance in such situations.

#### WARNING

Make sure that no persons or animals are in the maneuvering range. Otherwise, they could be injured.

- !** Pay particular attention to low objects or objects with flat surfaces, such as trailer drawbars, posts, cross beams and curbs. These types of objects cannot be detected by Parking Guidance and may damage the vehicle.

When PARKTRONIC is deactivated, Parking Guidance is also unavailable.

Use Parking Guidance for parking spaces:

- that are parallel to the direction of travel
- that are on straight roads, not bends
- that are on the same level as the road, i.e. not on the pavement, for example. Parking Guidance may not detect flat curbs

Parking tips:

- on narrow roads, drive past the parking space as close as possible.
- parking spaces that are littered, overgrown or partially occupied by trailer drawbars might be identified incorrectly or not at all.

- snowfall or heavy rain may lead to a parking space being measured inaccurately.
- pay attention to the PARKTRONIC (▷ page 153) warning messages during the parking procedure.
- when transporting a load which protrudes from your vehicle, you must not use Parking Guidance.
- never use Parking Guidance with snow chains or an emergency spare wheel mounted.
- make sure that the tire pressures are always correct. This has a direct effect on the steering instructions.
- the way your vehicle is positioned in the parking space after parking is dependent on various factors. These include the position and shape of the vehicles parked in front and behind it and the conditions of the location. In some cases, Parking Guidance may guide you too far or not far enough into a parking space. In some cases, it may also lead you across or onto the curb. If necessary, cancel the parking procedure with Parking Guidance.

- !** If unavoidable, you should drive over obstacles such as curbs slowly and not at a sharp angle. Otherwise, you may damage the wheels or tires.

### Detecting a parking space

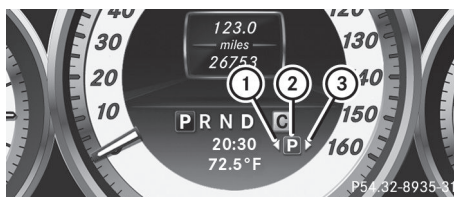

- ① Detected parking space on the left
- ② Parking symbol
- ③ Detected parking space on the right

Parking Guidance is automatically activated when you drive forwards. The system is operational at speeds of up to approximately 22 mph (35 km/h). While in operation, the

system independently locates and measures parking spaces on both sides of the vehicle. When driving at speeds below 19 mph (30km/h), you will see parking symbol ② as a status indicator in the instrument cluster. When a parking space has been detected, an arrow towards the right ③ or the left ① also appears. Parking Guidance only displays parking spaces on the front-passenger side as standard. Parking spaces on the driver's side are displayed as soon as the turn signal on the driver's side is activated. To park on the driver's side, you must leave the driver's side turn signal switched on until you have engaged reverse gear.

Parking Guidance will only detect parking spaces:

- that are parallel to the direction of travel
- that are at least 5 ft (1.5 m) wide
- that are at least 4.3 ft (1.3 m) longer than your vehicle

A parking space is displayed while you are driving past it, and until you are approximately 50 ft (15 m) away from it.

## Parking

### WARNING

The Parking Guidance is only an aid and may not detect all obstacles. The Parking Guidance does not relieve you of the responsibility to pay attention. You are always responsible for safety and must continue to pay attention to your immediate surroundings when parking and maneuvering. Otherwise, you could endanger yourself and others.

- ▶ Stop the vehicle when the parking space symbol shows the desired parking space in the instrument cluster.
- ▶ Shift the transmission to position **R**. The following message appears in the multifunction display: **Check vehicle surroundings Confirm with OK**.
- ▶ Press the **OK** button on the multifunction steering wheel to confirm. The multifunction display switches to Parking Guidance. Depending on your distance from the parking space, the **Please drive backwards** message appears in the multifunction display.



- ▶ If necessary, reverse towards the parking space. This is indicated by an arrow pointing backwards. Continue backing up until you hear a tone. Stop – the parking position has been reached. The arrow is white. The **Please steer to the right** or **Please steer to the left** message appears in the multifunction display.



- ▶ While the vehicle is stationary, turn the steering wheel in the specified direction until the arrow is white and a warning tone sounds.
- ▶ **To reverse into the parking space:** maintain the steering wheel angle and reverse carefully.

- ▶ Stop as soon as you hear a warning tone, The vehicle has reached the position in which you need to countersteer.  
The **Please steer to the left** or **Please steer to the right** message appears in the multifunction display.
- ▶ **Countersteering:** while the vehicle is stationary, turn the steering wheel in the specified direction until the arrow is white and a warning tone sounds.
- ▶ **To reverse into the parking space:** maintain the steering wheel angle and reverse carefully.
- ▶ Stop as soon as you hear a warning tone, at the latest when PARKTRONIC sounds the continuous warning tone.  
The **Parking Guidance finished** message appears in the multifunction display and a warning tone sounds. You may be asked to steer in a different direction and then change gear. In this case, further displays in the multifunction display will direct you to the final position.
- ▶ Maneuver if necessary.
- ▶ Always observe the warning messages displayed by PARKTRONIC (▷ page 153).

### Canceling Parking Guidance

- ▶ Press the PARKTRONIC button on the center console (▷ page 154).  
Parking Guidance is canceled immediately and PARKTRONIC is deactivated.

Parking Guidance is canceled automatically if it is no longer possible to guide you into the parking space, or if a malfunction occurs.

The parking space symbol goes out and a warning tone sounds. The **Parking Guidance Canceled** message appears in the multifunction display.

### Rear view camera

#### Important safety notes

The rear view camera is an optical parking aid. It shows the area behind your vehicle in the COMAND display.

#### WARNING

Make sure that no persons or animals are in the maneuvering range. Otherwise, they could be injured.

The rear view camera is located in the handle strip of the trunk lid.

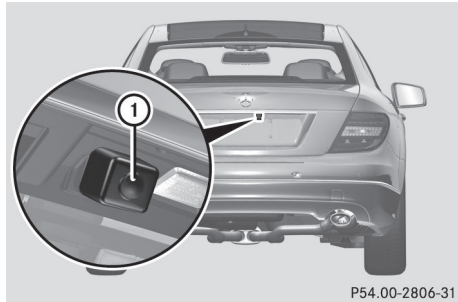

P54.00-2806-31

- ① Rear view camera

#### View through the camera

The area behind the vehicle is displayed as a mirror image, as in the rear view mirror.

#### WARNING

The rear view camera is only an aid and may display obstacles

- from a distorted perspective
- inaccurately
- may not display obstacles at all

The rear view camera does not relieve you of the responsibility to be cautious. Take care and pay careful attention. The rear view camera may not show objects which are

- very close to the rear bumper
- under the rear bumper
- above the trunk handle

You are responsible for safety at all times and must continue to pay attention to the immediate surroundings when parking and maneuvering. This includes the area behind, in front of, and beside the vehicle. Otherwise you could endanger yourself and/or others.

#### **WARNING**

The rear view camera will not function or will not fully function if:

- the trunk lid is open
  - it is raining or snowing strongly or if it is foggy
  - it is night or if you are parking/ maneuvering your vehicle in a very dark area
  - a very bright white light is affecting the camera
  - the immediate vicinity is illuminated with fluorescent light (the display of the COMAND system can flicker)
  - temperature changes abruptly, for example if you drive out of the cold into a heated garage (condensation on the lens)
  - the camera lens is dirty or covered
  - the rear of your vehicle is damaged
- In this case, have the position and the setting of the camera checked at a specialist workshop. Mercedes-Benz recommends that you consult a Mercedes-Benz Center for this purpose.

Do not use the rear view camera in these situations. You could otherwise injure yourself and other people and/or cause damage - including damage to your vehicle - while parking/maneuvering.

#### **Activating the rear view camera**

- ▶ Make sure that the SmartKey is in position **2** in the ignition lock.
- ▶ Make sure that the rear view camera function is selected in COMAND (see the

separate operating instructions for COMAND).

- ▶ Engage reverse gear.  
The area behind the vehicle is shown in the COMAND display.

#### **ATTENTION ASSIST**

##### **Important safety notes**

ATTENTION ASSIST helps you during long, monotonous journeys such as on freeways and interstate highways. It is active in the range between 50 mph (80 km/h) and 112 mph (180 km/h).

If ATTENTION ASSIST detects typical indicators of fatigue or increasing lapses in concentration on the part of the driver, it suggests you take a break.

#### **WARNING**

ATTENTION ASSIST is only an aid and may detect your tiredness or lapses in concentration too late or not at all. It is not a substitute for a well-rested and attentive driver.

Fatigue may cause you to recognize hazardous situations too late, misjudge a situation or react more slowly. For this reason, make sure you feel rested before you begin driving and during your journey. Make sure that you take regular breaks in time, particularly on long journeys. Otherwise, you may fail to recognize dangers in time, cause an accident and injure yourself and others.

ATTENTION ASSIST assesses your level of fatigue or lapses in concentration by taking the following criteria into account:

- your personal driving style, e.g. steering characteristics
- driving conditions, e.g. time, driving time

The functionality of ATTENTION ASSIST is restricted and warnings may be delayed or not occur at all:

- if the road condition is poor, e.g. if the surface is uneven or if there are potholes
- if there is a strong side wind
- if you have adopted a sporty driving style with high cornering speeds or high rates of acceleration
- if you are predominantly driving slower than 50 mph (80 km/h) or faster than 112 mph (180 km/h)
- if you are currently using COMAND or making a telephone call with it
- if the time has been set incorrectly
- in active driving situations, such as when you change lanes or change your speed

### Warning and display messages in the multifunction display



- Activate ATTENTION ASSIST using the on-board computer (▷ page 176). Symbol ① appears in the multifunction display.

If ATTENTION ASSIST is active, you will be warned no sooner than 20 minutes after your journey has begun. You will then hear an intermittent warning tone twice, and the **Attention Assist: Drowsiness Detected** message appears in the multifunction display.

- If necessary, take a break.
- Press **OK** to confirm the message.

On long journeys, take regular breaks in good time to allow yourself to rest properly. If you do not take a break, you will be warned again after 15 minutes at the earliest. The

precondition for this is that ATTENTION ASSIST still detects typical indicators of fatigue or increasing lapses in concentration.

ATTENTION ASSIST is reset when you continue your journey and starts assessing your tiredness again if:

- you switch off the engine.
- you take off your seat belt and open the driver's door, e.g. for a change of drivers or to take a break.

### Lane Tracking package

#### General notes

The Lane Tracking package consists of Blind Spot Assist (▷ page 160) and Lane Keeping Assist (▷ page 162).

#### Blind Spot Assist

##### Important safety notes

Blind Spot Assist uses a radar sensor system to monitor the areas on both sides of your vehicle. It supports you from speeds of approximately 20 mph (30 km/h). A warning display in the exterior mirrors draws your attention to vehicles detected in the monitored area. If you then switch on the corresponding turn signal to change lane, you will also receive an optical and audible collision warning. Blind Spot Assist uses sensors in the rear bumper for monitoring purposes.

##### **⚠ WARNING**

Blind Spot Assist is only an aid designed to assist driving. It may fail to detect some vehicles and is no substitute for attentive driving.

Blind Spot Assist cannot detect road and traffic conditions. It may fail to detect narrow vehicles, such as motorcycles or bicycles, or may only detect them too late.



Monitoring may be affected by dirty sensors, strong spray or poor visibility caused by snow, rain or mist, for example. In this case, vehicles are detected late or not at all.

Always pay attention to traffic conditions and your surroundings. Otherwise, you may fail to recognize dangers in time, cause an accident and injure yourself and others.

**i** USA only:

This device has been approved by the FCC as a “Vehicular Radar System”. The radar sensor is intended for use in an automotive radar system only. Removal, tampering, or altering of the device will void any warranties, and is not permitted by the FCC. Do not tamper with, alter, or use in any non-approved way.

Any unauthorized modification to this device could void the user’s authority to operate the equipment.

For Blind Spot Assist to assist you when driving, the radar sensor system must be activated (▷ page 180) and operational.

### Monitoring range of the sensors

Active Blind Spot Assist monitors the area up to 10 ft (3 m) behind your vehicle and directly next to your vehicle, as shown in the diagram.

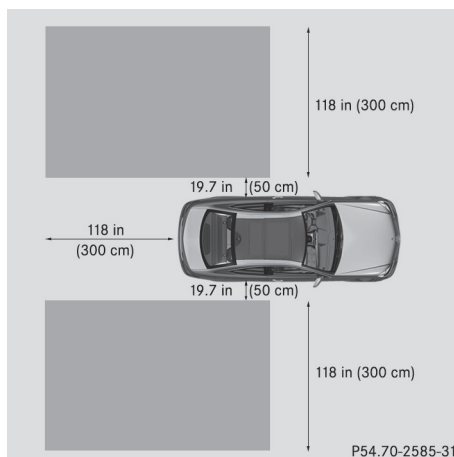

### **⚠** WARNING

Blind Spot Assist monitors certain areas in the immediate vicinity of your vehicle. Vehicles that approach and drive past at high speeds are not detected. There is no display and no warning.

If the lanes are very wide, it may not be possible to monitor the complete width of the neighboring lane. For this reason, vehicles in the next lane may not be detected, especially if they are driving in a staggered formation. This may be the case if vehicles are driving at that edge of their lane which is furthest away from your vehicle.

Always pay attention to traffic conditions and your surroundings. Otherwise, you may fail to recognize dangers in time, cause an accident and injure yourself and others.

If the lanes are narrow, vehicles driving in the lane beyond the lane next to your vehicle may be indicated, especially if the vehicles are not driving in the middle of their lane. This may be the case if there are vehicles driving at the inner edge of their lanes.

Due to the nature of the system:

- warnings may be issued in error when driving close to crash barriers or similar solid lane borders.
- warnings may be interrupted when driving alongside long vehicles, for example trucks, for a prolonged time.

The two radar sensors for Blind Spot Assist are integrated into the sides of the rear bumper. Make sure that the bumper is free from dirt, ice or slush around the sensors. The sensors must not be covered, for example by cycle racks or overhanging loads. Following a severe impact or in the event of damage to the bumpers, have the function of the sensors checked at a qualified specialist workshop. Blind Spot Assist may otherwise not work properly.

### Indicator and warning display

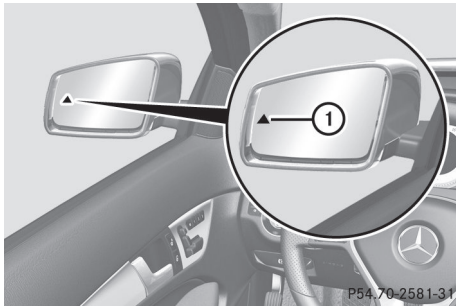

#### ① Yellow indicator lamp/red warning lamp

When Blind Spot Assist is activated, indicator lamp ① in the exterior mirrors lights up yellow at speeds of up to 20 mph (30 km/h). At speeds above 20 mph (30 km/h), the indicator lamp goes out and Blind Spot Assist is operational.

If a vehicle is detected within the monitoring range of Blind Spot Assist at speeds above 20 mph (30 km/h), warning lamp ① on the corresponding side lights up red. This warning is always emitted when a vehicle enters the blind spot monitoring range from behind or from the side. When you overtake a vehicle, the warning only occurs if the difference in speed is less than 7 mph (12 km/h).

The yellow indicator lamp goes out if reverse gear is engaged. In this event, Blind Spot Assist is no longer active.

The brightness of the indicator/warning lamps is adjusted automatically according to the ambient light.

#### **WARNING**

Blind Spot Assist is not active at speeds below approximately 20 mph (30 km/h). The indicator lamps in the exterior mirrors are yellow. Vehicles in the monitoring range are then not indicated.

Always pay attention to traffic conditions and your surroundings. Otherwise, you may fail to recognize dangers in time, cause an accident and injure yourself and others.

### Collision warning

If a vehicle is detected in the monitoring range of Blind Spot Assist and you switch on the corresponding turn signal, a double warning tone sounds. Red warning lamp ① flashes. If the turn signal remains on, detected vehicles are indicated by the flashing of red warning lamp ①. There are no further warning tones.

### Switching on Blind Spot Assist

- ▶ Make sure that the radar sensor system (▷ page 180) and Blind Spot Assist (▷ page 177) are activated in the on-board computer.
- ▶ Turn the SmartKey to position **2** in the ignition lock.  
Warning lamps ① light up red in the exterior mirrors for approximately 1.5 seconds and then turn yellow.

### Lane Keeping Assist

#### Important safety notes

Lane Keeping Assist monitors the area in front of your vehicle by means of a camera at the top of the windshield. Lane Keeping Assist detects lane markings on the road and warns you before you leave your lane unintentionally.

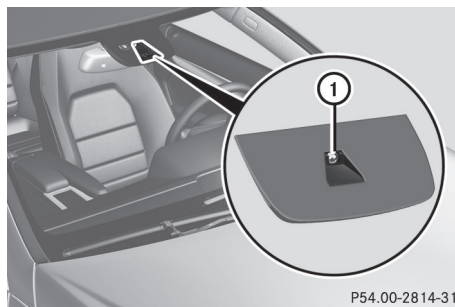

#### ① Lane Keeping Assist camera

If you have chosen the **Display unit Speed-/odometer** (▷ page 177) function in the on-board computer and select **km** as the unit of measurement, Lane Keeping Assist is active from speeds of 60 km/h. If the **miles**

display unit is selected, the assistance range begins at 40 mph.

#### WARNING

Lane Keeping Assist does not keep your vehicle in its lane. It is only an aid and may detect the lane markings on the road incorrectly or not at all.

The system may be impaired or may not function if:

- there is poor visibility, e.g. due to insufficient illumination of the road, or due to snow, rain, fog or spray.
- there is glare, e.g. from oncoming traffic, the sun, or reflection from other vehicles.
- the windshield is dirty, fogged up or covered, for instance by a sticker, in the vicinity of the camera.
- several or no lane markings for a single lane are present.
- the lane markings are worn away, dark or covered up, e.g. by dirt or snow.
- the distance to the vehicle in front is too small and the lane markings thus cannot be detected.
- the lane markings on the road are unclear, e.g. near roadworks.
- the lane markings change quickly, e.g. lanes branch off, cross one another or merge.
- the road is narrow and winding.

Lane Keeping Assist cannot detect road and traffic conditions. It is not a substitute for attentive driving. You are responsible for the vehicle's speed, braking in good time, and steering correctly. Always adapt your driving style to suit the prevailing road and weather conditions. Always pay attention to traffic conditions and your surroundings. Otherwise, you may fail to recognize dangers in time, cause an accident and injure yourself and others.

A warning may be given if a front wheel passes over a lane marking. It will warn you

by means of intermittent vibration in the steering wheel for up to 1.5 seconds.

In order that you are warned only when necessary and in good time if you cross the lane marking, the system recognizes certain conditions and warns you accordingly.

The warning vibration occurs earlier if:

- you approach the outer lane marking on a bend.
- the road has very wide lanes, e.g. a freeway.
- the system recognizes solid lane markings.

The warning vibration occurs later if:

- the road has narrow lanes.
- you cut the corner on a bend.

No warning vibration occurs if:

- you clearly and actively steer, brake or accelerate.
- you cut the corner on a sharp bend.
- a driving safety system intervenes, e.g. ABS, BAS or ESP®.
- you switch on the turn signals. In this event, the warnings are suppressed for a certain period of time.

#### Switching on Lane Keeping Assist

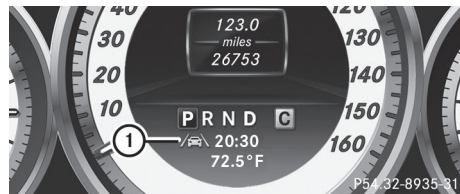

- ▶ Activate Lane Keeping Assist using the on-board computer (> page 177). Symbol ① appears in the multifunction display.

If your speed exceeds 40 mph (60 km/h) and lane markings are detected, symbol ① is highlighted in green. Lane Keeping Assist is ready for use.



Useful information .....	166
Important safety notes .....	166
Displays and operation .....	166
Menus and submenus .....	170
Display messages .....	185
Warning and indicator lamps in the instrument cluster .....	210

### Useful information

- i** This Operator's Manual describes all models and all standard and optional equipment of your vehicle available at the time of publication of the Operator's Manual. Country-specific differences are possible. Please note that your vehicle may not be equipped with all features described. This also applies to safety-related systems and functions.
- i** Please read the information on qualified specialist workshops (▷ page 23).

### Important safety notes

You will find an illustration of the instrument cluster in the "At a glance" section (▷ page 29).

#### WARNING

The driver's concentration must always be directed primarily at road traffic.

For your safety and the safety of others, selecting features through the multifunction steering wheel should only be done by the driver when traffic and road conditions permit it to be done safely.

Bear in mind that at a speed of only 30 mph (approximately 50 km/h), the vehicle covers a distance of 44 feet (approximately 14 m) per second.

#### WARNING

No messages will be displayed if either the instrument cluster or the multifunction display is inoperative.

As a result, you will not be able to see information about your driving conditions, such as

- speed
- outside temperature
- warning/indicator lamps

- malfunction/warning messages
- failure of any systems

Driving characteristics may be impaired.

If you must continue to drive, do so with added caution. Contact an authorized Mercedes-Benz Center as soon as possible.

#### WARNING

Malfunction and warning messages are only indicated for certain systems and are intentionally not very detailed. The malfunction and warning messages are simply a reminder with respect to the operation of certain systems. They do not replace the owner's and/or driver's responsibility to maintain the vehicle's operating safety. Have all required maintenance and safety checks performed on the vehicle. Bring the vehicle to an authorized Mercedes-Benz Center to address the malfunction and warning messages.

### Displays and operation

#### Coolant temperature display

#### WARNING

Driving when your engine is overheated can cause some fluids which may have leaked into the engine compartment to catch fire. You could be seriously burned.

Steam from an overheated engine can cause serious burns which can occur just by opening the engine hood. Stay away from the engine if you see or hear steam coming from it.

Stop the vehicle in a safe location away from other traffic. Turn off the engine, get out of the vehicle and do not stand near the vehicle until the engine has cooled down.

The coolant temperature gauge is in the instrument cluster on the left-hand side.

Under normal operating conditions and with the specified coolant level, the coolant temperature may rise to 248 °F (120 °C).

**!** A display message is shown if the coolant temperature is too high.

If the coolant temperature is over 248 °F (120 °C), do not continue driving. The engine will otherwise be damaged.

### Tachometer

The red band in the tachometer indicates the engine's overrevving range.

**!** Do not drive in the overrevving range, as this could damage the engine.

The fuel supply is interrupted to protect the engine when the red band is reached.

### Outside temperature display

The outside temperature display is in the multifunction display (▷ page 168).

#### **⚠ WARNING**

The outside temperature indicator is not designed to serve as an ice-warning device and is therefore unsuitable for that purpose.

Indicated temperatures just above the freezing point do not guarantee that the road surface is free of ice. The road may still be icy, especially in wooded areas or on bridges.

Changes in the outside temperature are displayed after a short delay.

### Speedometer with segments

The segments in the speedometer indicate which speed range is available.

Cruise control (▷ page 146) activated:

The segments light up from the stored speed to the maximum speed.

## Operating the on-board computer

### Overview

The on-board computer is activated as soon as you turn the SmartKey to position **1** in the ignition lock.

You can control the multifunction display and the settings in the on-board computer using the buttons on the multifunction steering wheel.



- ① Multifunction display
- ② Switches on the Voice Control System; see the separate operating instructions
- ③ Right control panel
- ④ Left control panel
- ⑤ Back button



### Left control panel

◀ ▶	<ul style="list-style-type: none"> <li>• Calls up the menu and menu bar</li> </ul>
▲ ▼	<p><b>Press briefly:</b></p> <ul style="list-style-type: none"> <li>• Scrolls in lists</li> <li>• Selects a submenu or function</li> <li>• In the <b>Audio</b> menu: selects a stored station, an audio track or a video scene</li> <li>• In the <b>Tel</b> (telephone) menu: switches to the phone book and selects a name or telephone number</li> </ul>
▲ ▼	<p><b>Press and hold:</b></p> <ul style="list-style-type: none"> <li>• In the <b>Audio</b> menu: selects the previous/next station or selects an audio track or a video scene using rapid scrolling</li> <li>• In the <b>Tel</b> (telephone) menu: starts rapid scrolling through the phone book</li> </ul>
OK	<ul style="list-style-type: none"> <li>• Confirms a selection/display message</li> <li>• In the <b>Tel</b> (telephone) menu: switches to the telephone book and starts dialing the selected number</li> <li>• In the <b>Audio</b> menu: stops the station search function at the desired station</li> </ul>

### Right control panel

📞	<ul style="list-style-type: none"> <li>• Rejects or ends a call</li> <li>• Exits phone book/redial memory</li> </ul>
📞	<ul style="list-style-type: none"> <li>• Makes or accepts a call</li> <li>• Switches to the redial memory</li> </ul>

+	• Adjusts the volume
-	
🔇	• Mute

### Back button



↩	<p><b>Press briefly:</b></p> <ul style="list-style-type: none"> <li>• Back</li> <li>• Switches off the Voice Control System; see the separate operating instructions</li> <li>• Hides display messages or calls up the last <b>Trip</b> menu function used</li> <li>• Exits the telephone book/redial memory</li> </ul>
↩	<p><b>Press and hold:</b></p> <ul style="list-style-type: none"> <li>• Calls up the standard display in the <b>Trip</b> menu</li> </ul>

### Multifunction display

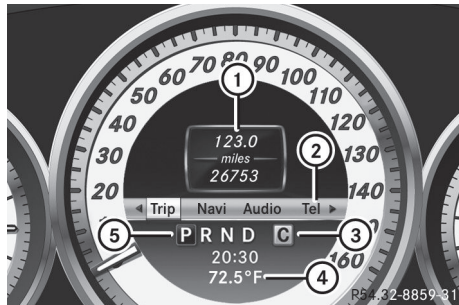
Values and settings as well as display messages are shown in the multifunction display.



- ① Description field
- ② Menu bar
- ③ Drive program
- ④ Outside temperature or speed  
(▷ page 178)
- ⑤ Transmission position





► **To show menu bar ②:** press the  or  button on the steering wheel.

Menu bar ② disappears after a few seconds.

Text field ① shows the selected menu or submenu as well as display messages.

**i** You can set the time using Audio 20 or COMAND; see the separate Operating Instructions.

The following messages may appear in the multifunction display:

-  Parking Guidance (▷ page 155)
-  Adaptive Highbeam Assist (▷ page 102)
-  ATTENTION ASSIST (▷ page 159)
-  Lane Keeping Assist (▷ page 162)
-  HOLD function (▷ page 149)

## Menus and submenus

## Menu overview

The number of menus shown depends on the optional equipment in the vehicle.

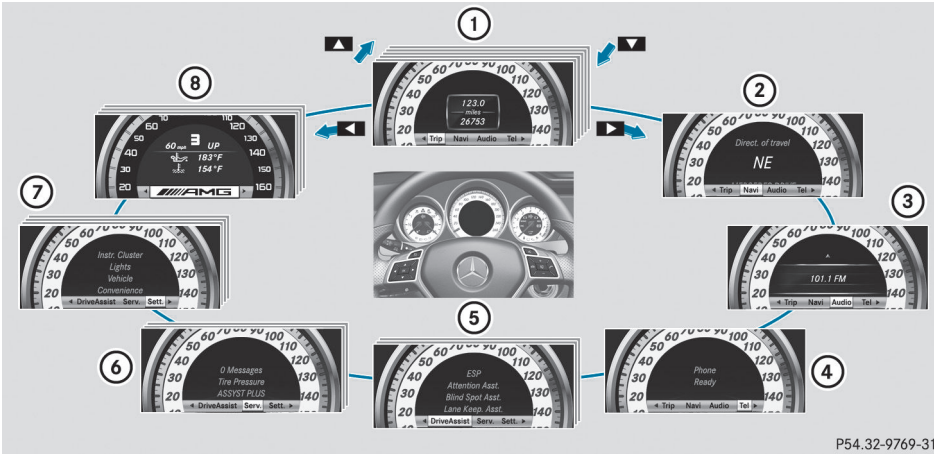

P54\_32-9769-31

## Function

- |   | Function   |
|---|--|
| ① | <b>Trip</b> menu (▷ page 171)  |
| ② | <b>Navi</b> menu (navigation details) (▷ page 172)   |
| ③ | <b>Audio</b> menu (▷ page 173)   |
| ④ | <b>Tel</b> menu (telephone) (▷ page 174)   |
| ⑤ | <b>DriveAssist</b> menu (assistance) (▷ page 176)  |
| ⑥ | <b>Serv.</b> menu (▷ page 177) <ul style="list-style-type: none"> <li>calling up display messages (▷ page 185)</li> <li>tire pressure loss warning system (Canada only) (▷ page 283)</li> <li>tire pressure monitor (▷ page 284)</li> <li>ASSYST PLUS service interval display (▷ page 250)</li> </ul> |
| ⑦ | <b>Settings</b> menu (▷ page 177)  |
| ⑧ | <b>AMG</b> menu in AMG vehicles (▷ page 181)   |

Depending on the audio system installed, the display messages in the **Audio** and **Tel** menus differ slightly. The examples given in this Operator's Manual apply to vehicles equipped with COMAND.

**Trip menu**

**Standard display**

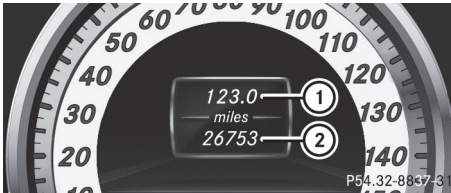

- ▶ Press and hold the button on the steering wheel until the ① menu with trip odometer 1 and odometer 2 is shown. ②

**Trip computer "From start" or "From reset"**

The values in the **From Start** submenu are calculated from the start of a journey, while the values in the **From Reset** submenu are calculated from the last time the submenu was reset (▷ page 172).

- ▶ Press the or button on the steering wheel to select the **Trip** menu.
- ▶ Press the or button to select **From start** or **From reset**.

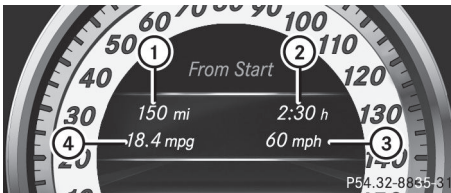

Example: trip computer "From start"

- ① Distance
- ② Time
- ③ Average speed
- ④ Average fuel consumption

The **From Start** trip computer is reset automatically when:

- the ignition has been switched off for more than four hours.
- 999 hours have been exceeded.
- 9999 miles have been exceeded.

When 9,999 hours or 99,999 miles have been exceeded, the trip computer is automatically reset **From Reset**.

**Displaying the range and current fuel consumption**

- ▶ Press the or button on the steering wheel to select the **Trip** menu.
- ▶ Press the or button to select the current fuel consumption and the approximate range (except for AMG vehicles).

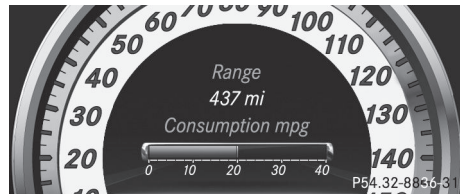

The approximate range that can be covered depends on the fuel level and your current driving style. If there is only a small amount of fuel left in the fuel tank, the display shows a vehicle being refueled instead of the range.

**Digital speedometer**



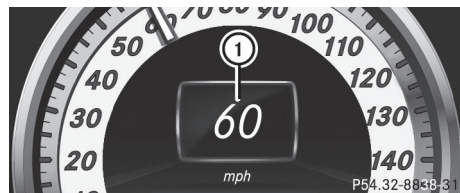

- ▶ Press the or button on the steering wheel to select the **Trip** menu.
- ▶ Press or to select the digital speedometer.



- ① Digital speedometer



### Resetting values

You can reset the values of the following functions:

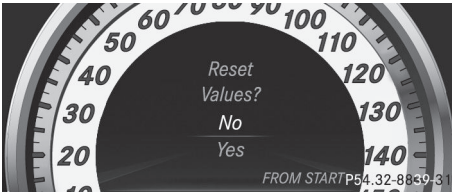
- trip odometer
- trip computer "From start"
- trip computer "From reset"
- ▶ Press the  or  button on the steering wheel to select the **Trip** menu.
- ▶ Press the  or  button to select the function that you wish to reset.
- ▶ Press .





Resetting the trip computer "From start" (example)

- ▶ Press  to select **Yes** and press  to confirm.

### Navigation system menu

#### Displaying navigation instructions

In the **Navi** menu, the multifunction display shows navigation instructions. For more information, see the separate operating instructions.

- ▶ Switch on COMAND (see the separate operating instructions).
- ▶ Press the  or  button on the steering wheel to select the **Navi** menu.

### Route guidance not active

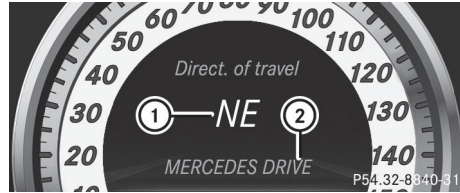

- ① Direction of travel
- ② Current street

### Route guidance active

#### No change of direction announced

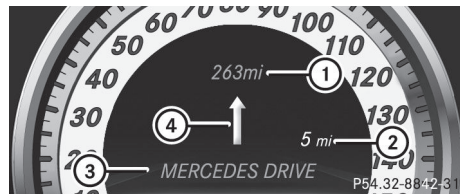

- ① Distance to the destination
- ② Distance to the next change of direction
- ③ Current street
- ④ Symbol "follow the road's course"

#### Change of direction announced without a lane recommendation

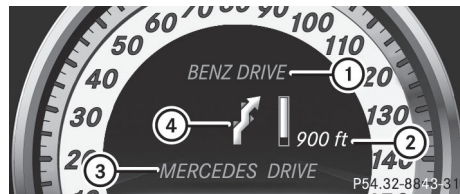

- ① Road into which the change of direction leads
- ② Distance to change of direction and visual distance display
- ③ Current street
- ④ Symbol for change of direction

When a change of direction has been announced, you will see visual distance display ② next to the symbol of change of

direction ④. This decreases in size as you approach the announced change of direction.

**Change of direction announced with a lane recommendation**

Lane recommendations are only displayed if the relevant data is available on the digital map.

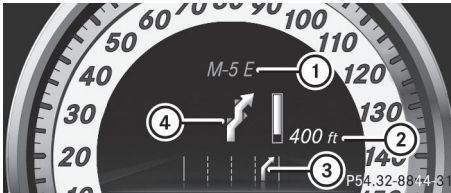

- ① Road into which the change of direction leads
- ② Distance to change of direction and visual distance display
- ③ Lane recommendation
- ④ Symbol for change of direction

On multilane roads, lane recommendation ③ may be shown for the next change of direction. During the change of direction, additional lanes may be displayed.

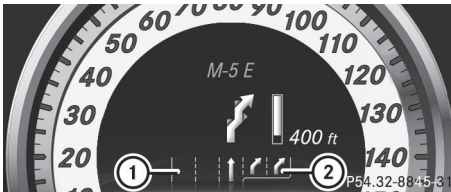

Lane recommendation display (example)

- ① Uninterrupted lane
- ② New lane during a change of direction

**Other status indicators of the navigation system**

-  : you have reached the destination or an intermediate destination.
- **New Route...** or **Calculating Route:** a new route is being calculated.



- **Off Map** or **Off Mapped Road:** the vehicle position is outside the area of the digital map (off-map position).
- **No Route:** no route could be calculated to the selected destination.

**Audio menu**

**Selecting a radio station**







- ① SIRIUS XM satellite radio functions like a normal radio.  
For more information on satellite radio operation, see the separate operating instructions.

You can only change the waveband and store new stations using Audio 20 or COMAND.

- ▶ Switch on Audio 20 or COMAND (see the separate operating instructions) and select Radio.
- ▶ Press the  or  button on the steering wheel to select the **Audio** menu.



- ① Waveband
- ② Station<sup>10</sup>

- ▶ **To select a stored station:** briefly press the  or  button.
- ▶ **To select a station from the station list:** press and briefly hold the  or  button.
- ▶ **To select a station using station search<sup>11</sup>:** press and briefly hold the  or  button.

<sup>10</sup> If the station has been stored, the memory position will also be displayed.

<sup>11</sup> Only if no station list is received.

### Operating audio player or audio media

Audio data from various audio devices or media can be played, depending on the equipment installed in the vehicle.

- ▶ Switch on Audio 20 or COMAND and select the audio device or medium (see the separate operating instructions).
- ▶ Press the ◀ or ▶ button on the steering wheel to select the **Audio** menu.



CD changer display (example)

① Current title

- ▶ **To select the next/previous track:** briefly press the ▲ or ▼ button.
- ▶ **To select a track from the track list (rapid scrolling):** press and hold the ▲ or ▼ button until the desired track has been reached.

If you press and hold the ▲ or ▼ button, the rapid scrolling speed is increased. Not all audio drives or data carriers support this function.

If track information is stored on the audio device or medium, the multifunction display will show the number and name of the track. The current track does not appear in audio AUX mode (**A**uxiliary audio mode: external audio source connected).

### Video DVD operation

- ▶ Switch on COMAND and select video DVD (see the separate operating instructions).
- ▶ Press the ◀ or ▶ button on the steering wheel to select the **Audio** menu.

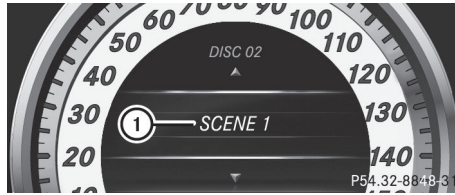

DVD changer display (example)

① Current scene

- ▶ **To select the next or previous scene:** briefly press the ▲ or ▼ button.
- ▶ **To select a scene from the scene list (rapid scrolling):** press and hold the ▲ or ▼ button until the desired scene has been reached.

### Telephone menu

#### Introduction

You can establish a Bluetooth® connection to Audio 20 or to COMAND (see the separate operating instructions).

#### ⚠ WARNING

The driver's attention to the road must always be his/her primary focus when driving. For your safety and the safety of others, we recommend that you pull over to a safe location and stop before placing or taking a telephone call. If you choose to use the telephone while driving, please use the hands-free device and only use the telephone when road, weather and traffic conditions permit. Some jurisdictions prohibit the driver from using a mobile phone while driving a vehicle. Bear in mind that at a speed of just 30 mph (approximately 50 km/h), your vehicle covers a distance of 44 feet (approximately 14 m) every second.

- ▶ Switch on the mobile phone and Audio 20 or COMAND (see the separate operating instructions).
- ▶ Press the ◀ or ▶ button on the steering wheel to select the **Te**l menu.



You will see one of the following display messages in the multifunction display:

- **Telephone ready** or the name of the network provider: the mobile phone has found a network and is ready to receive.
- **Telephone No Service**: no network is available, or the mobile phone is searching for a network.

### Accepting a call

If someone calls you when you are in the **Te1** menu, a display message appears in the multifunction display, for example:



- ▶ Press the  button on the steering wheel to accept an incoming call.

If you are not in the **Te1** menu, you can still accept a call.







### Rejecting or ending a call



- ▶ Press the  button on the steering wheel.

If you are not in the **Te1** menu, you can still reject or end a call.

### Dialing a number from the phone book

If your mobile phone is able to receive calls, you can search for and dial a number from the phone book in Audio 20 or COMAND.

- ▶ Press the  or  button on the steering wheel to select the **Te1** menu.
- ▶ Press the , , or **OK** button to call up the phone book.
- ▶ Press the  or  button to select the desired name.

To start scrolling rapidly, press and hold the  or  button for longer than one

second. After a short time, the rapid scroll speeds up.

Rapid scrolling stops when you release the button or reach the end of the list.

- ▶ **If only one telephone number is stored for a name:** press the  or **OK** button to start dialing.



or

- ▶ **If there is more than one number for a particular name:** press the  or **OK** button to display the numbers.

- ▶ Press the  or  button to select the number you want to dial.







- ▶ Press the  or **OK** button to start dialing.

or



- ▶ **If you do not want to make a call:** press the  or  button.

### Redialing

The on-board computer saves the last names or numbers dialed in the redial memory.

- ▶ Press the  or  button on the steering wheel to select the **Te1** menu.
- ▶ Press the  button to switch to the redial memory.
- ▶ Press the  or  button to select the desired name or number.
- ▶ Press the  or **OK** button to start dialing.

or

- ▶ **If you do not want to make a call:** press the  or  button.

## Assistance menu

### Introduction

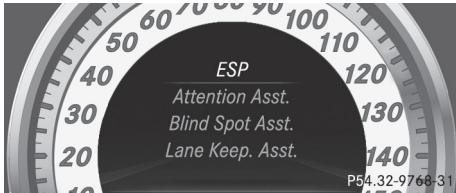

In the **DriveAssist** menu, you have the following options:

- activating/deactivating ESP®
- activating/deactivating ATTENTION ASSIST
- activating/deactivating Blind Spot Assist
- activating/deactivating Lane Keeping Assist

### Deactivating/activating ESP®

#### **WARNING**



Under no circumstances should you deactivate ESP® when the  ESP® warning lamp in the instrument cluster flashes. Proceed as follows:

- when driving off, apply as little throttle as possible.
- while driving, ease up on the accelerator pedal.
- adapt your speed to suit the prevailing road and weather conditions.

Failure to observe these guidelines could cause the vehicle to skid. ESP® cannot prevent accidents resulting from excessive speed.



Activating/deactivating ESP® on AMG vehicles (▷ page 61).

For further information about ESP®, see (▷ page 60).

- ▶ Start the engine.
- ▶ Press  or  on the steering wheel to select the **Assist.** menu.



- ▶ Press the  or  button to select **ESP.**

- ▶ Press the  button.

- ▶ **To deactivate:** press  again. The  warning lamp in the instrument cluster comes on.

#### **WARNING**

When the  ESP® OFF warning lamp is lit, ESP® is deactivated.

If the  ESP® warning lamp and the  ESP® OFF warning lamp remain lit, ESP® is not available due to a malfunction.



When ESP® is deactivated or not operational, vehicle stability in standard driving maneuvers is reduced.

Adapt your speed and driving to the prevailing road conditions and to the non-operating status of the ESP®.

- ▶ **To activate:** press  again.

The  warning lamp in the instrument cluster goes out.

### Activating/deactivating ATTENTION ASSIST

- ▶ Press the  or  button on the steering wheel to select the **DriveAssist** menu.

- ▶ Press the  or  button to select **Attention Asst..**

- ▶ Press .
- The current selection is displayed.

- ▶ **To activate/deactivate:** press  again.

When ATTENTION ASSIST (▷ page 159) is activated, the  symbol appears in the multifunction display when the ignition is on.

### Activating/deactivating Blind Spot Assist

You can use the **Blind Spot Asst.** function to activate or deactivate Blind Spot Assist (▷ page 160).

- ▶ Press the ◀ or ▶ button on the steering wheel to select the **DriveAssist** menu.
- ▶ Press ▲ or ▼ to select **Blind Spot Asst.**
- ▶ Press the **OK** button.  
If the function is activated, the monitored areas are shown in red in the multifunction display.
- ▶ **To activate/deactivate:** press the **OK** button again.

### Activating/deactivating Lane Keeping Assist

You can use the **Lane Keep. Asst.** function to activate or deactivate Lane Keeping Assist (▷ page 162).

- ▶ Press the ◀ or ▶ button on the steering wheel to select the **DriveAssist** menu.
- ▶ Press ▲ or ▼ to select **Lane Keep. Asst.**
- ▶ Press the **OK** button.  
If the function is activated, the road markings are shown in red in the multifunction display.
- ▶ **To activate/deactivate:** press the **OK** button again.

When Lane Keeping Assist is activated, the  symbol appears in the multifunction display when the ignition is on.

### Service menu



In the **Service** menu, you have the following options:

- calling up display messages (▷ page 185)
- restarting the tire pressure loss warning system (Canada only) (▷ page 283)
- checking the tire pressure electronically (▷ page 284)
- calling up a service due date (▷ page 250)

### Settings menu

#### Introduction

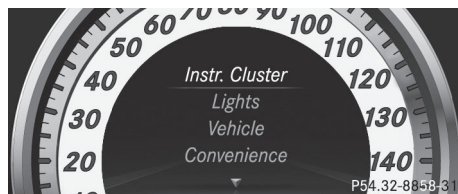

The **Sett.** menu can be used for:









- changing the instrument cluster settings
- changing the light settings
- changing the vehicle settings
- changing the convenience settings
- restoring the factory settings

### Instrument cluster

#### Selecting the unit of measurement for distance









The **Display Unit Speed-/Odometer:** function allows you to choose whether certain displays appear in kilometers or miles.

The selected unit of measurement for distance applies to:

- digital speedometers in the **Trip** menu
- odometer and the trip odometer
- Trip computer
- current consumption and the range
- navigation instructions in the **Navi** menu
- ASSYST PLUS service interval display
- ▶ Press the  or  button on the steering wheel to select the **Sett.** menu.
- ▶ Press the  or  button to select the **Instr. Cluster** submenu.
- ▶ Press  to confirm.
- ▶ Press the  or  button to select the **Display Unit Speed-/Odometer:** function.  
You will see the selected setting: **km** or **miles**.
- ▶ Press the  button to save the setting.

### Selecting the permanent display function

The **Permanent Display:** function allows you to choose whether the multifunction display always shows the outside temperature or the speed in km/h (USA) or mph (Canada).

- ▶ Press the  or  button on the steering wheel to select the **Settings** menu.
- ▶ Press the  or  button to select the **Instr. cluster** submenu.
- ▶ Press the  button to confirm.
- ▶ Press the  or  button to select the **Permanent display** function.  
You will see the selected setting **Outside Temperature** or **Speedometer [km/h]:**.
- ▶ Press the  button to save the setting.









## Lights

### Switching the daytime running lamps on/off







This function is not available in Canada.

If you have activated the **Day Running Lights:** function and the light switch is in the  or **AUTO** position, the daytime running lamps are switched on automatically when the engine is running.

Depending on the ambient light, the following will additionally light up:

- low-beam headlamps
- parking lamps
- tail lamps
- license plate lamp
- side marker lamps
- ▶ Press the  or  button on the steering wheel to select the **Settings** menu.
- ▶ Press the  or  button to select the **Light** submenu.
- ▶ Press the  button to confirm.
- ▶ Press the  or  button to select the **Daytime running lights** function.  
If the **Daytime running lights** have been switched on, the cone of light and the  symbol in the multifunction display are shown in red.
- ▶ Press the  button to save the setting.



### Switching Adaptive Highbeam Assist on/off

- ▶ Press the  or  button on the steering wheel to select the **Sett.** menu.
- ▶ Press the  or  button to select the **Lights** submenu.
- ▶ Press the  button to confirm.
- ▶ Press the  or  button to select the **Adapt. Highbeam** function.  
If the **Adapt. Highbeam** function has been switched on, the cone of light and the

 symbol in the multifunction display are shown in red.

- ▶ Press the  button to save the setting.









### Activating/deactivating surround lighting and exterior lighting delayed switch-off

If you have activated the **Surround Lighting** function and the light switch is in the  or  position, the following functions are active when it is dark:

- **Surround lighting:** the exterior lighting remains lit for 40 seconds after unlocking with the key. The exterior lighting switches off when you open the driver's door.
- **Exterior lighting delayed switch-off:** the exterior lighting remains lit for 60 seconds after the engine is switched off. If you close all the doors, the exterior lighting goes off after 15 seconds.

If you activate the **Surround lighting** function, the following light up depending on the vehicle's equipment:

- parking lamps
- front fog lamps
- daytime running lamps
- side marker lamps
- surround lighting in the exterior mirrors

- ▶ Press the  or  button on the steering wheel to select the **Sett.** menu.
- ▶ Press the  or  button to select the **Lights** submenu.
- ▶ Press the  button to confirm.
- ▶ Press the  or  button to select the **Surround Lighting** function.  
When the **Surround lighting** function is activated, the light cone and the area around the vehicle are displayed in red in the multifunction display.
- ▶ Press the  button to save the setting.









Deactivating delayed switch-off of the exterior lighting temporarily:

- ▶ Before leaving the vehicle, turn the SmartKey to position **0** in the ignition lock.
- ▶ Turn the SmartKey to position **2** in the ignition lock and back to position **0**. The exterior lighting delayed switch-off is deactivated.

Delayed switch-off of the exterior lighting is reactivated the next time you start the engine.

### Activating/deactivating the interior lighting delayed switch-off

If you activate the **Light. delay** function, the interior lighting remains on for 20seconds after you remove the key from the ignition lock.









- ▶ Press the  or  button on the steering wheel to select the **Settings** menu.
- ▶ Press the  or  button to select the **Light** submenu.
- ▶ Press the  button to confirm.
- ▶ Press the  or  button to select the **Interior lighting delay sw. off:** function.  
When the **Light. delay** function is activated, the vehicle interior is displayed in red in the multifunction display.
- ▶ Press the  button to save the setting.

## Vehicle

### Activating/deactivating the automatic door locking mechanism









If you select the **Auto. Door Locks** function, the vehicle is centrally locked above a speed of around 9 mph (15km/h).

- ▶  For further information on the automatic locking feature, see (> page 73).

- ▶ Press the  or  button on the steering wheel to select the **Settings** menu.
- ▶ Press the  or  button to select the **Vehicle** submenu.
- ▶ Press the  button to confirm.
- ▶ Press the  or  button to select the **Auto. door lock** function.  
When the **Auto. door locks** function is activated, the vehicle doors are displayed in red in the multifunction display.
- ▶ Press the  button to save the setting.





#### Activating/deactivating the acoustic locking verification signal





If you activate the **Acoustic Lock** function, an audible signal sounds depending on the vehicle's date of manufacture:

- when locking  
or
  - once when unlocking and three times when locking
- ▶ Press the  or  button on the steering wheel to select the **Settings** menu.
  - ▶ Press the  or  button to select the **Vehicle** submenu.
  - ▶ Press the  button to confirm.
  - ▶ Press the  or  button to select the **Acoustic Lock** function.  
If the **Acoustic Lock** function is activated, the  symbol in the multifunction display lights up red.
  - ▶ Press the  button to save the setting.

#### Activating/deactivating the radar sensor system

If the radar sensor system is switched off, Blind Spot Assist (▷ page 160) is deactivated.

- ▶ Press the  or  button on the steering wheel to select the **Sett.** menu.
- ▶ Press the  or  button to select the **Vehicle** submenu.

- ▶ Press  to confirm.
- ▶ Press the  or  button to select **Radar Sensor (See Oper. Manual)**.  
You will see the selected setting: **Enabled** or **Disabled**.
- ▶ Press the  button to save the setting.

#### Convenience

##### Activating/deactivating the EASY-ENTRY/EXIT feature









You can use the **Easy Entry/Exit** function to activate or deactivate the EASY ENTRY/EXIT feature (▷ page 92).

##### WARNING

You must make sure no one can become trapped or injured by the moving steering wheel when the easy-entry/exit feature is activated.

To stop steering wheel movement, move steering wheel adjustment lever or press one of the memory position buttons.









Do not leave children unattended in the vehicle, or with access to an unlocked vehicle. Children could open the driver's door and unintentionally activate the easy-entry/exit feature, which could result in an accident and/or serious personal injury.

- ▶ Press the  or  button on the steering wheel to select the **Settings** menu.
- ▶ Press the  or  button to select the **Convenience** submenu.
- ▶ Press the  button to confirm.
- ▶ Press the  or  button to select the **Easy Entry/Exit** function.  
If the **Easy Entry/Exit** function is activated, the vehicle steering wheel is displayed in red in the multifunction display.
- ▶ Press the  button to save the setting.

### Switching the fold-in mirrors when locking feature is on/off









If you switch on the **Auto. Mirror Folding** function, the exterior mirrors fold in when you lock the vehicle. If you unlock the vehicle and then open a door, the exterior mirrors fold out again.

If you have switched the function on and you fold the exterior mirrors in using the button on the door (> page 93), they will not fold out automatically. The exterior mirrors can then only be folded out using the button on the door.

- ▶ Press the  or  button on the steering wheel to select the **Settings** menu.
- ▶ Press the  or  button to select the **Convenience** submenu.
- ▶ Press the  button to confirm.
- ▶ Press the  or  button to select the **Auto. fold in** function.  
If the **Auto. fold in** function is activated, the vehicle's exterior mirror is displayed in red in the multifunction display.
- ▶ Press the  button to save the setting.



### Restoring the factory settings

For safety reasons, the **Day Lights** function in the **Lights** submenu is only reset when the vehicle is stationary.

- ▶ Press the  or  button on the steering wheel to select the **Sett.** menu.
- ▶ Press the  or  button to select the **Factory Setting** submenu.
- ▶ Press the  button to confirm.  
The **Reset All Settings?** message appears.
- ▶ Press the  or  button to select **No** or **Yes**.
- ▶ Press the  button to confirm the selection.  
If you select **Yes**, the multifunction display shows a confirmation message.

### AMG menu in AMG vehicles

#### AMG displays

- ▶ Press the  or  button on the steering wheel to select the **AMG** menu.

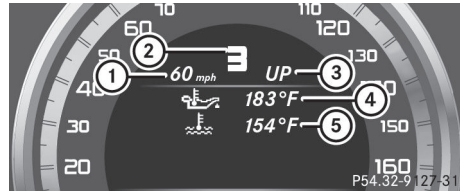



- ① Digital speedometer
- ② Gear indicator
- ③ Upshift indicator
- ④ Engine oil temperature
- ⑤ Coolant temperature

Upshift indicator **UP** ③ indicates that the engine has reached the overrevving range when in the manual gearshift program. Upshift indicator **UP** ③ fades out other messages until you have shifted up.

When the engine oil temperature is below 80 °C, the oil temperature is shown in blue. Avoid driving at full engine output during this time.

### SETUP

SETUP shows the drive program, the ESP® (Electronic Stability Program) mode and the SPORT handling mode.

- ▶ Press the  or  button on the steering wheel to select the **AMG** menu.
- ▶ Press the  button repeatedly until SETUP is displayed.



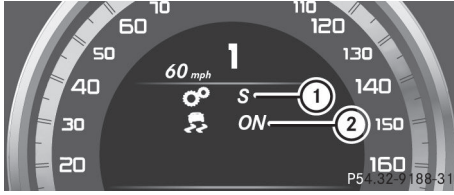

- ① Drive program (C/S/S+/M)
- ② ESP® mode (ON/OFF) or SPORT handling mode (SPORT)



## RACETIMER



### Displaying and starting RACETIMER

#### WARNING

The RACETIMER feature is only for use on roads and in conditions where high speed driving is permitted. Racing on public roads is prohibited under all circumstances. The driver is and must always remain responsible for following posted speed limits.

You can use the RACETIMER to store lap times.

- ▶ Press the  or  button on the steering wheel to select the **AMG** menu.
- ▶ Press the  button repeatedly until the RACETIMER is shown.

- i** If RACETIMER is selected, the menu bar cannot be called up with the  and  buttons.

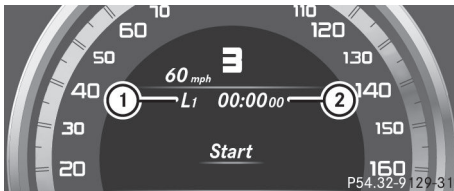





- ① Lap
- ② RACETIMER

You can start the RACETIMER when the engine is running or if the SmartKey is in position **2** in the ignition lock.

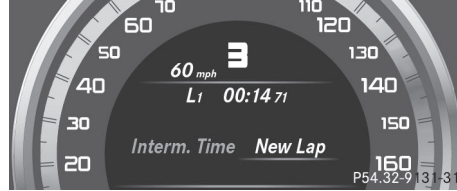
- ▶ **To start:** press the  button to start the RACETIMER.

### Displaying the intermediate time



- ▶ Press the  or  button to select **Interm. Time**.
- ▶ Press the  button to confirm. The intermediate time is displayed for five seconds.

### Starting a new lap

- ▶ Press  to confirm **New Lap**.

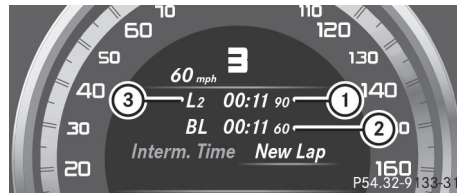

- ① RACETIMER
- ② Fastest lap time (best lap)
- ③ Lap

- i** It is possible to store a maximum of sixteen laps. Lap sixteen can only be finished with **Finish Lap**.

### Stopping the RACETIMER

- ▶ Press the  button on the steering wheel.

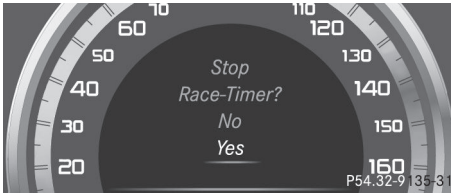

- ▶ Press **OK** to confirm **YES**.

The RACETIMER interrupts timing when you stop the vehicle and turn the SmartKey to position **1** in the ignition lock. If you turn the SmartKey to position **2** or **3** and then press the **OK** button to confirm **Start**, timing is continued.

### Resetting the current lap

- ▶ Stop the RACETIMER.
- ▶ Press the **◀** or **▶** button to select **Reset Lap**.
- ▶ Press **OK** to reset the lap time to "0".

### Deleting all laps

If you switch off the engine, the RACETIMER is reset to "0" after 30 seconds. All laps are deleted.

You cannot delete individual stored laps. If you have stopped 16 laps, the current lap does not have to be reset.

- ▶ Reset the current lap.
- ▶ Press **OK** to confirm **Reset**. **Reset Race Timer?** appears in the multifunction display.

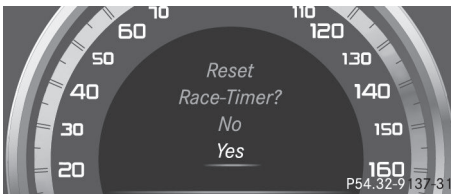

- ▶ Press the **▼** button to select **Yes** and press the **OK** button to confirm. All laps are deleted.

### Overall statistics

This function is shown if you have stored at least one lap and stopped the RACETIMER.

- ▶ Press **◀** or **▶** on the steering wheel to select the **AMG** menu.
- ▶ Press the **▲** button repeatedly until the overall evaluation is shown.

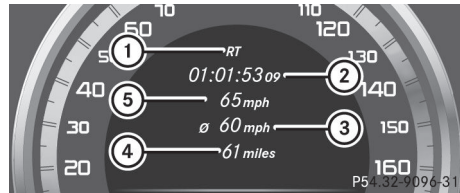

- ① RACETIMER overall evaluation
- ② Total time driven
- ③ Average speed
- ④ Distance covered
- ⑤ Top speed

### Lap statistics

This function is only available if you have stored at least two laps and have stopped the RACETIMER.

- ▶ Press the **◀** or **▶** button on the steering wheel to select the **AMG** menu.
- ▶ Press the **▲** button repeatedly until the lap evaluation is shown.

Each lap is shown in a separate submenu. The fastest lap is indicated by flashing symbol ①.

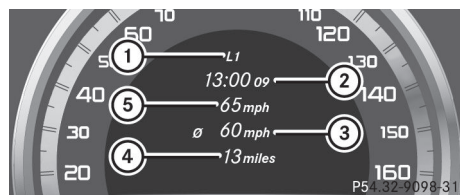

- ① Lap
- ② Lap time
- ③ Average lap speed

- ④ Lap length
- ⑤ Top speed during lap
- ▶ Press the  or  button to select a different lap evaluation.

## Display messages

### General notes

#### WARNING

All categories of messages contain important information which should be taken note of and, where a malfunction is indicated, addressed as soon as possible at an authorized Mercedes-Benz Center.

Failure to repair the condition noted may cause damage not covered by the Mercedes-Benz Limited Warranty, or result in property damage or personal injury.

Display messages appear in the multifunction display.

Display messages with graphic displays may be shown in simplified form in the Operator's Manual and may differ from the messages shown in the multifunction display.



Please respond in accordance with the display messages and follow the additional notes in this Operator's Manual.

Certain display messages are accompanied by an audible warning tone or a continuous tone.

When you stop and park the vehicle, please observe the notes on the HOLD function (▷ page 149) and parking (▷ page 140).

### Hiding display messages

You can hide some display messages with a low priority.







- ▶ Press the  or  button on the steering wheel to hide the display message. The display message is cleared.

Display messages with a high priority are shown in red.

You cannot hide display messages of the highest priority. The multifunction display shows these messages continuously until the causes for the messages have been remedied.

### Message memory

The **message memory** allows you to call up previous display messages.

- ▶ Press  or  on the steering wheel to select the **Serv.** menu. If there are display messages, the multifunction display shows **2 Messages**, for example.
- ▶ Press the  or  button to select the entry, e.g. **2 Messages**.
- ▶ Confirm with .
- ▶ Press the  or  button to scroll through the display messages.

When the ignition is switched off, all display messages are deleted, apart from some high-priority display messages. Once the causes of the high-priority display messages have been rectified, the corresponding display messages are also deleted.

## Safety systems

## Display messages



Currently  
Unavailable See  
Oper. Manual

## Possible causes/consequences and ► Solutions

**Risk of accident**

ABS (Anti-lock Braking System), ESP® (Electronic Stability Program), BAS (Brake Assist), the HOLD function and hill start assist are temporarily unavailable.

In addition, the , and warning lamps light up in the instrument cluster.

The self-diagnosis function might not be complete, for example. ATTENTION ASSIST is deactivated.

The brake system continues to function normally, but without the functions listed above. The wheels could therefore lock if you brake hard, for example.

- Carefully drive a short distance on a suitable stretch of road, making slight steering movements at a speed above 12 mph (20 km/h).

If the display message disappears, the functions mentioned above are available again.

If the display message continues to be displayed:

- Drive on carefully.
- Visit a qualified specialist workshop.

**Risk of accident**

ABS, ESP®, BAS, the HOLD function and hill start assist are temporarily unavailable.

In addition, the , and warning lamps light up in the instrument cluster.

For example, the on-board voltage may be insufficient.











ATTENTION ASSIST is deactivated.









The brake system continues to function normally, but without the functions listed above. The wheels could therefore lock if you brake hard, for example.

- Drive on carefully.
- If the display message disappears, the functions mentioned above are available again.





If the display message continues to be displayed:

- Drive on carefully.
- Visit a qualified specialist workshop.

Display messages	Possible causes/consequences and ► Solutions
 <p>Inoperative See Oper. Manual</p>	<p><b>⚠ Risk of accident</b></p> <p>ABS, ESP®, BAS, the HOLD function and hill start assist are unavailable due to a malfunction.</p> <p>The <b>BRAKE</b> (USA only)/ <b>(D)</b> (Canada only), ,  and  warning lamps in the instrument cluster also light up.</p> <p>The brake system continues to function normally, but without the functions listed above. The wheels could therefore lock if you brake hard, for example.</p> <p>ATTENTION ASSIST is deactivated.</p> <ul style="list-style-type: none"> <li>► Drive on carefully.</li> <li>► Visit a qualified specialist workshop immediately.</li> </ul>
 <p>Currently Unavailable See Operator's Manual</p>	<p><b>⚠ Risk of accident</b></p> <p>ESP®, BAS, the HOLD function and hill start assist are temporarily unavailable.</p> <p>In addition, the  and  warning lamps light up in the instrument cluster.</p> <p>The self-diagnosis function might not be complete, for example. ATTENTION ASSIST is deactivated.</p> <p>The brake system continues to function normally, but without the functions listed above.</p> <ul style="list-style-type: none"> <li>► Carefully drive a short distance on a suitable stretch of road, making slight steering movements at a speed above 12 mph (20 km/h). If the display message disappears, the functions mentioned above are available again.</li> </ul> <p>If the display message continues to be displayed:</p> <ul style="list-style-type: none"> <li>► Drive on carefully.</li> <li>► Visit a qualified specialist workshop.</li> </ul>
 <p>Inoperative See Operator's Manual</p>	<p><b>⚠ Risk of accident</b></p> <p>ESP®, BAS, the HOLD function and hill start assist are unavailable due to a malfunction.</p> <p>In addition, the  and  warning lamps light up in the instrument cluster.</p> <p>ATTENTION ASSIST is deactivated.</p> <p>The brake system continues to function normally, but without the functions listed above.</p> <ul style="list-style-type: none"> <li>► Drive on carefully.</li> <li>► Visit a qualified specialist workshop.</li> </ul>

Display messages	Possible causes/consequences and ► Solutions
  Inoperative See Operator's Manual	<p> <b>Risk of accident</b></p> <p>EBD (electronic brake force distribution), ABS, ESP®, BAS, the HOLD function and hill start assist are unavailable due to a malfunction.</p> <p>In addition, the ,  and  warning lamps light up in the instrument cluster and a warning tone sounds. ATTENTION ASSIST is deactivated.</p> <p>The brake system continues to function normally, but without the functions listed above. The wheels could therefore lock if you brake hard, for example.</p> <ul style="list-style-type: none"> <li>► Drive on carefully.</li> <li>► Visit a qualified specialist workshop immediately.</li> </ul>
 Check Brake Pad Wear	<p>The brake pads/linings have reached their wear limit.</p> <ul style="list-style-type: none"> <li>► Visit a qualified specialist workshop.</li> </ul>
 Release Parking Brake	<p>You are driving with the parking brake applied. A warning tone also sounds.</p> <ul style="list-style-type: none"> <li>► Release the parking brake.</li> </ul>



Display messages	Possible causes/consequences and ► Solutions
<p><b>BRAKE</b> (USA only)  (Canada only)</p> <p><b>Brake Immediately</b></p>	<p>A malfunction has occurred while the HOLD function is active. A tone may also sound at regular intervals. If you attempt to lock the vehicle, the tone becomes louder. You cannot start the engine.</p> <ul style="list-style-type: none"> <li>► Paying attention to the traffic situation, immediately depress the brake pedal firmly and hold until the display message disappears.</li> <li>► Prevent the vehicle from rolling away before you leave it (&gt; page 262). You can restart the engine.</li> </ul>
<p><b>BRAKE</b> (USA only)  (Canada only)</p> <p><b>Check Brake Fluid Level</b></p>	<p> <b>Risk of accident</b></p> <p>There is not enough brake fluid in the brake fluid reservoir. Additionally, the red <b>BRAKE</b> (USA only)/  (Canada only) warning lamp lights up in the instrument cluster and a warning tone sounds.</p> <ul style="list-style-type: none"> <li>► Pull over and stop the vehicle safely as soon as possible, paying attention to road and traffic conditions. Do not continue driving under any circumstances.</li> <li>► Apply the parking brake.</li> <li>► Consult a qualified specialist workshop.</li> <li>► Do not add brake fluid. This does not correct the malfunction.</li> </ul>

 **WARNING**

Driving with the message **Check Brake Fluid Level** displayed can result in an accident. Have your brake system checked immediately.

Do not add brake fluid before checking the brake system. Overfilling the brake fluid reservoir can result in spilling brake fluid on hot engine parts and the brake fluid catching fire. You can be seriously burned.

Display messages	Possible causes/consequences and ► Solutions
 <p>Tele Aid Inoperative</p>	<p>USA only: one or more of the main functions in the mbrace system are malfunctioning.</p> <p>Canada only: one or more of the main functions of the TELEAID system are malfunctioning.</p> <ul style="list-style-type: none"> <li>► USA only: have the mbrace system checked at a qualified specialist workshop.</li> <li>► Canada only: have the TELEAID system checked at a qualified specialist workshop.</li> </ul>
 <p>SRS Malfunction Service Required</p>	<p> <b>Risk of injury</b></p> <p>There is a malfunction in the SRS (Supplemental Restraint System). The  warning lamp also lights up in the instrument cluster.</p> <ul style="list-style-type: none"> <li>► Visit a qualified specialist workshop.</li> </ul>
 <p>Front Left Malfunction Service Required or Front Right Malfunction Service Required</p>	<p> <b>Risk of injury</b></p> <p>SRS has malfunctioned at the front on the left or right. The  warning lamp also lights up in the instrument cluster.</p> <ul style="list-style-type: none"> <li>► Visit a qualified specialist workshop.</li> </ul>
 <p>Rear Left Malfunction Service Required or Rear Right Malfunction Service Required</p>	<p> <b>Risk of injury</b></p> <p>SRS has malfunctioned at the rear on the left or right. The  warning lamp also lights up in the instrument cluster.</p> <ul style="list-style-type: none"> <li>► Visit a qualified specialist workshop.</li> </ul>
 <p>Left Side Curtain Airbag Malfunction Service Required or Right Side Curtain Airbag Malfunction Service Required</p>	<p> <b>Risk of injury</b></p> <p>There is a malfunction in the left-hand or right-hand window curtain air bag.</p> <p>The  warning lamp also lights up in the instrument cluster.</p> <ul style="list-style-type: none"> <li>► Visit a qualified specialist workshop.</li> </ul>

 **WARNING**

In the event a malfunction of the SRS is indicated as outlined above, the SRS may not be operational.

For your safety, we strongly recommend that you contact an authorized Mercedes-Benz Center immediately to have the system checked. Otherwise the SRS may not be activated when needed in an accident, which could result in serious or fatal injury, or it might deploy unexpectedly and unnecessarily which could also result in injury.

**Display messages**

Front Passenger  
Airbag Enabled  
See Operator's  
Manual

**Possible causes/consequences and ► Solutions**

The front-passenger air bag is enabled during the journey, even though:



- a child, a small adult or an object weighing less than the system's weight threshold is located on the front-passenger seat.
- or
- the front-passenger seat is unoccupied.

The system may detect objects or forces applying additional weight on the seat.



- Pull over and stop the vehicle safely as soon as possible, paying attention to road and traffic conditions.
- Apply the parking brake.
- Switch the ignition off.
- Open the front-passenger door.
- Remove the child and the child restraint system from the front-passenger seat.
- If necessary, secure the child in a child restraint system on a suitable rear seat.
- Make sure that there are no objects on the seat adding to the weight.

The system may otherwise detect the additional weight and interpret the seat occupant's weight as greater than it actually is.

- Keep the seat unoccupied, close the front-passenger door and switch on the ignition.

Observe the   (> page 44) indicator lamp and the multifunction display and check the following:

Seat unoccupied and ignition switched on:







- the   indicator lamp must light up and remain lit. When the indicator lamp is on, OCS (> page 44) has disabled the front-passenger air bag.
- the following display messages must not appear in the multifunction display: **Front Passenger Airbag Enabled See Operator's Manual** or **Front Passenger Airbag Disabled See Operator's Manual**.
- Wait for a period of at least 60 seconds until the necessary system checks have been completed.
- Make sure that the display messages do not appear in the multifunction display.

Display messages	Possible causes/consequences and ► Solutions
	<p>If these conditions are fulfilled, the front-passenger seat can be occupied again. Whether the  indicator lamp remains lit or goes out depends on how OCS classifies the occupant.</p> <p>If the conditions are not fulfilled, the system is not operating correctly.</p> <p>► Visit a qualified specialist workshop immediately.</p>



 **WARNING**

If the  indicator lamp remains off even after performing the above corrective steps, do not have any children twelve years old and under and other small individuals use the front-passenger seat until the system has been repaired.



Display messages	Possible causes/consequences and ► Solutions
<p>Front Passenger Airbag Disabled See Operator's Manual</p>	<p>The front-passenger air bag is disabled during the journey, although:</p> <ul style="list-style-type: none"> <li>• an adult or</li> <li>• a person larger than a certain size is occupying the front-passenger seat.</li> </ul> <p>If additional forces are applied to the seat, the system may interpret the occupant's weight as lower than it actually is.</p> <ul style="list-style-type: none"> <li>► Pull over and stop the vehicle safely as soon as possible, paying attention to road and traffic conditions.</li> <li>► Apply the parking brake.</li> <li>► Switch the ignition off.</li> <li>► Have the occupant get out of the vehicle.</li> <li>► Keep the seat unoccupied, close the front-passenger door and switch on the ignition.</li> </ul> <p>Observe the   (&gt; page 44) indicator lamp and the multifunction display and check the following:</p> <p>Seat unoccupied and ignition switched on:</p> <ul style="list-style-type: none"> <li>• the   indicator lamp must light up and remain lit. When the indicator lamp is on, OCS (&gt; page 44) has disabled the front-passenger air bag.</li> <li>• the following display messages must not appear in the multifunction display: <a href="#">Front Passenger Airbag Enabled See Operator's Manual</a> or <a href="#">Front Passenger Airbag Disabled See Operator's Manual</a>.</li> </ul> <ul style="list-style-type: none"> <li>► Wait for a period of at least 60 seconds until the necessary system checks have been completed.</li> <li>► Make sure that the display messages do not appear in the multifunction display.</li> </ul> <p>If these conditions are fulfilled, the front-passenger seat can be occupied again. Whether the   indicator lamp remains lit or goes out depends on how OCS classifies the occupant.</p> <p>If the conditions are not fulfilled, the system is not operating correctly.</p> <ul style="list-style-type: none"> <li>► Visit a qualified specialist workshop immediately.</li> </ul>





 **WARNING**

If the   indicator lamp remains lit with an adult occupant on the front-passenger seat even after performing the above corrective steps, do not have any passenger use the front-passenger seat until the system has been repaired.







**Lights**









**i** Display messages about LEDs:

This display message will only appear if all LEDs have failed.

Display messages	Possible causes/consequences and ► Solutions
 <p>Check Left Cornering Light or Check Right Cornering Light</p>	<p>The left or right-hand cornering light is defective.</p> <ul style="list-style-type: none"> <li>► Check whether you are permitted to change the bulb yourself (▷ page 104).</li> <li>or</li> <li>► Visit a qualified specialist workshop.</li> </ul>
 <p>Check Left Low Beam or Check Right Low Beam</p>	<p>The left or right-hand low-beam headlamp is defective.</p> <ul style="list-style-type: none"> <li>► Check whether you are permitted to change the bulb yourself (▷ page 104).</li> <li>or</li> <li>► Visit a qualified specialist workshop.</li> </ul>
 <p>Check Rear Left Turn Signal or Check Rear Right Turn Signal</p>	<p>The rear left-hand or rear right-hand turn signal is defective.</p> <ul style="list-style-type: none"> <li>► Check whether you are permitted to change the bulb yourself (▷ page 104).</li> <li>or</li> <li>► Visit a qualified specialist workshop.</li> </ul>
 <p>Check Front Left Turn Signal or Check Front Right Turn Signal</p>	<p>The front left-hand or front right-hand turn signal is defective.</p> <ul style="list-style-type: none"> <li>► Check whether you are permitted to change the bulb yourself (▷ page 104).</li> <li>or</li> <li>► Visit a qualified specialist workshop.</li> </ul>
 <p>Check Left Mirror Turn Signal or Check Right Mirror Turn Signal</p>	<p>The turn signal in the left-hand or right-hand exterior mirror is defective.</p> <ul style="list-style-type: none"> <li>► Check whether you are permitted to change the bulb yourself (▷ page 104).</li> <li>or</li> <li>► Visit a qualified specialist workshop.</li> </ul>



Display messages	Possible causes/consequences and ► Solutions
 Check Center Brake Lamp	<p>The high-mounted brake lamp is faulty.</p> <ul style="list-style-type: none"> <li>► Check whether you are permitted to change the bulb yourself (&gt; page 104).</li> </ul> <p>or</p> <ul style="list-style-type: none"> <li>► Visit a qualified specialist workshop.</li> </ul>
 Check Left Tail and Brake Lamps or Check Right Tail and Brake Lamps	<p>The left or right-hand tail lamp/brake lamp is defective.</p> <ul style="list-style-type: none"> <li>► Check whether you are permitted to change the bulb yourself (&gt; page 104).</li> </ul> <p>or</p> <ul style="list-style-type: none"> <li>► Visit a qualified specialist workshop.</li> </ul>
 Check Left High Beam or Check Right High Beam	<p>The left or right-hand high beam is defective.</p> <ul style="list-style-type: none"> <li>► Check whether you are permitted to change the bulb yourself (&gt; page 104).</li> </ul> <p>or</p> <ul style="list-style-type: none"> <li>► Visit a qualified specialist workshop.</li> </ul>
 Check Left Fog Lamp or Check Right Fog Lamp	<p>The left-hand or right-hand front fog lamp is defective.</p> <ul style="list-style-type: none"> <li>► Check whether you are permitted to change the bulb yourself (&gt; page 104).</li> </ul> <p>or</p> <ul style="list-style-type: none"> <li>► Visit a qualified specialist workshop.</li> </ul>
 Rear Fog Lamp	<p>The rear fog lamp is defective.</p> <ul style="list-style-type: none"> <li>► Check whether you are permitted to change the bulb yourself (&gt; page 104).</li> </ul> <p>or</p> <ul style="list-style-type: none"> <li>► Visit a qualified specialist workshop.</li> </ul>
 Check Front Left Parking Lamp or Check Front Right Parking Lamp	<p>The front left or front right parking or standing lamp is defective.</p> <ul style="list-style-type: none"> <li>► Check whether you are permitted to change the bulb yourself (&gt; page 104).</li> </ul> <p>or</p> <ul style="list-style-type: none"> <li>► Visit a qualified specialist workshop.</li> </ul>

Display messages	Possible causes/consequences and ► Solutions
 Backup Light	The backup lamp is defective. ► Check whether you are permitted to change the bulb yourself (> page 104). or ► Visit a qualified specialist workshop.
 Check Front Left Sidemarker Lamp or Check Front Right Sidemarker Lamp	The left or right front side marker lamp is defective. ► Check whether you are permitted to change the bulb yourself (> page 104). or ► Visit a qualified specialist workshop.
 Check Rear Left Sidemarker Lamp or Check Rear Right Sidemarker Lamp	The rear left or right side marker lamp is defective. ► Check whether you are permitted to change the bulb yourself (> page 104). or ► Visit a qualified specialist workshop.
 Check Left Daytime Running Light or Check Right Daytime Running Light	The left or right-hand daytime running lamp is defective. ► Check whether you are permitted to change the bulb yourself (> page 104). or ► Visit a qualified specialist workshop.
 Active Headlamps Inoperative	The active light function is defective. ► Visit a qualified specialist workshop.
 Malfunction See Operator's Manual	The exterior lighting is defective. ► Visit a qualified specialist workshop.
 AUTO Lamp Function Inoperative	The light sensor is defective. ► Visit a qualified specialist workshop.
 Switch Off Lights	The lights are still switched on when you leave the vehicle. A warning tone also sounds. ► Turn the light switch to <b>A</b> or <b>AUTO</b> .

Display messages	Possible causes/consequences and ► Solutions
Adaptive Highbeam Assist Inoperative	Adaptive Highbeam Assist is faulty. ► Visit a qualified specialist workshop.
Adaptive Highbeam Assist Currently Unavailable See Operator's Manual	Adaptive Highbeam Assist is deactivated and temporarily inoperative. Possible causes are: <ul style="list-style-type: none"> <li>• the windshield in the camera's field of vision is dirty.</li> <li>• visibility is impaired due to heavy rain, snow or fog.</li> </ul> ► Clean the windshield. If the system detects that the camera is fully functional again, the <b>Adaptive Highbeam Assist Now Available</b> display message is shown. Adaptive Highbeam Assist is operational again.

## Engine



Display messages	Possible causes/consequences and ► Solutions
 Check Coolant Level See Operator's Manual	The coolant level is too low. ► Add coolant, observing the warning notes when doing so (► page 248). ► If coolant needs to be added more often than usual, have the engine coolant system checked at a qualified specialist workshop.

### WARNING

Do not spill antifreeze on hot engine parts. Antifreeze contains ethylene glycol which may burn if it comes into contact with hot engine parts. You could be seriously burned.

**!** The coolant level is too low. Avoid making long journeys with too little coolant in the cooling system. The engine will otherwise be damaged.

The display messages and the corresponding symbol that indicate that the coolant level is too low must not be ignored.

Display messages	Possible causes/consequences and ► Solutions
	<p>The engine fan is defective.</p> <ul style="list-style-type: none"> <li>▶ At coolant temperatures under 248 °F (120 °C), drive to the next qualified specialist workshop.</li> <li>▶ Avoid subjecting the engine to heavy loads, e.g. driving in mountainous terrain, and stop-and-go traffic.</li> </ul>
 Coolant Stop car, switch engine off	<p>The coolant is too hot.</p> <ul style="list-style-type: none"> <li>▶ Pull over and stop the vehicle safely and switch off the engine, paying attention to road and traffic conditions.</li> <li>▶ Make sure that the air supply to the engine radiator is not blocked, e.g. by snow, slush or ice.</li> <li>▶ Wait until the display message disappears before restarting the engine. Otherwise, the engine could be damaged.</li> <li>▶ Pay attention to the coolant temperature display.</li> <li>▶ If the temperature increases again, visit a qualified specialist workshop immediately.</li> </ul>



 **WARNING**

Driving when your engine is overheated can cause some fluids which may have leaked into the engine compartment to catch fire. You could be seriously burned.

Steam from an overheated engine can cause serious burns which can occur just by opening the engine hood. Stay away from the engine if you see or hear steam coming from it.

Stop the vehicle in a safe location away from other traffic. Turn off the engine, get out of the vehicle and do not stand near the vehicle until the engine has cooled down.



- !** If the coolant temperature is over 248 °F (120 °C), do not continue driving. The engine will otherwise be damaged.



Display messages	Possible causes/consequences and ► Solutions
	<p>The battery is not being charged.</p> <p>Possible causes are:</p> <ul style="list-style-type: none"> <li>• a defective alternator</li> <li>• a torn poly-V-belt</li> <li>• a malfunction in the electronics</li> </ul> <p>► Pull over and stop the vehicle safely and switch off the engine, paying attention to road and traffic conditions.</p> <p>► Open the hood.</p> <p>► Check whether the poly-V-belt is torn.</p> <p><b>If the poly-V-belt is torn:</b></p> <p><b>!</b> Do not continue driving. The engine could otherwise overheat.</p> <p>► Consult a qualified specialist workshop.</p> <p><b>If the poly-V-belt is not damaged:</b></p> <p>► Visit a qualified specialist workshop.</p>
 <p>Check Engine Oil At Next Refueling</p>	<p>The engine oil level has dropped to the minimum level. A warning tone also sounds.</p> <ul style="list-style-type: none"> <li>► Check the oil level when next refueling, at the latest (► page 247).</li> <li>► If necessary, add engine oil (► page 248).</li> <li>► Have the engine checked at a qualified specialist workshop if engine oil needs to be added more often than usual.</li> </ul>

Information on approved engine oils can be obtained from any qualified specialist workshop or on the Internet at <http://www.mbusa.com> (USA only).

**!** The oil level is too low. Avoid long journeys with too little engine oil. There is a risk of engine damage.

The display messages and the corresponding symbol that indicate that the oil level is too low must not be ignored.

Display messages	Possible causes/consequences and ► Solutions
 Fuel Level	The fuel level has dropped into the reserve range. ► Refuel at the nearest gas station.
 Fuel Level	There is only a very small amount of fuel in the fuel tank. ► Refuel at the nearest gas station without fail.
 Gas Cap Loose	The fuel system pressure is too low. The fuel filler cap is not closed correctly or the fuel system is leaking. ► Check that the fuel filler cap is correctly closed. <b>If the fuel filler cap is not correctly closed:</b> ► Close the fuel filler cap. <b>If the fuel filler cap is correctly closed:</b> ► Visit a qualified specialist workshop.

Driving systems	
Display messages	Possible causes/consequences and ► Solutions
 Attention Assist: Drowsiness Detected	Based on specific criteria, ATTENTION ASSIST has determined that the driver is tired or paying less attention. A warning tone also sounds. ► If necessary, take a break. During long journeys, take regular breaks in good time so you get enough rest.
 Attention Assist Inoperative	ATTENTION ASSIST has failed. ► Visit a qualified specialist workshop.
 HOLD Off	The HOLD function is deactivated. the vehicle is skidding. A warning tone also sounds. ► Reactivate the HOLD function later (► page 149). The HOLD function is deactivated. When the brake pedal is firmly depressed, an activation condition is not fulfilled. A warning tone also sounds. ► Check the activation conditions for the HOLD function (► page 149).

Display messages	Possible causes/consequences and ► Solutions
Radar Sensors Deactivated See Operator's Manual	<p>The radar sensor system is deactivated.</p> <p>► Switch on the radar sensor system (► page 180).</p>
Lane Keeping Assist Currently Unavailable See Operator's Manual	<p>Lane Keeping Assist is deactivated and temporarily inoperative. Possible causes are:</p> <ul style="list-style-type: none"> <li>• the windshield in the camera's field of vision is dirty.</li> <li>• visibility is impaired due to heavy rain, snow or fog.</li> <li>• there are no lane markings for a longer period.</li> <li>• the lane markings are worn, dark or covered, e.g. by dirt or snow.</li> </ul> <p>If the display message does not disappear:</p> <p>► Pull over and stop the vehicle safely as soon as possible, paying attention to road and traffic conditions.</p> <p>► Apply the parking brake.</p> <p>► Clean the windshield.</p> <p>If the system detects that the camera is fully operational, the display message disappears.</p> <p>Lane Keeping Assist is operational again.</p>
Lane Keeping Assist Inoperative	<p>Lane Keeping Assist is faulty.</p> <p>► Visit a qualified specialist workshop.</p>
Blind Spot Assist Currently Unavailable See Operator's Manual	<p>Blind Spot Assist is temporarily inoperative. Possible causes are:</p> <ul style="list-style-type: none"> <li>• the sensors are dirty.</li> <li>• function is impaired due to heavy rain or snow.</li> <li>• the radar sensor system is outside the operating temperature range.</li> <li>• the radar sensor system is temporarily inoperative, e.g. due to electromagnetic radiation emitted by nearby TV or radio stations or other sources of electromagnetic radiation.</li> </ul> <p>The yellow  indicator lamps also light up in the exterior mirrors.</p> <p>If the display message does not disappear:</p> <p>► Pull over and stop the vehicle safely as soon as possible, paying attention to road and traffic conditions.</p> <p>► Apply the parking brake.</p> <p>► Clean the sensors (► page 255).</p> <p>► Restart the engine.</p> <p>If the system detects that the sensors are fully operational, the display message disappears.</p> <p>Blind Spot Assist is operational again.</p>



Display messages	Possible causes/consequences and ► Solutions
Blind Spot Assist Inoperative	<p>Blind Spot Assist is defective.</p> <p>The yellow  indicator lamps also light up in the exterior mirrors.</p> <p>► Visit a qualified specialist workshop.</p>
Parking Guidance Inoperative	<p>Parking Guidance is malfunctioning (▷ page 155).</p> <p>► Restart the engine.</p> <p>If the display message continues to be displayed:</p> <p>► Visit a qualified specialist workshop.</p>
Parking Guidance Canceled	<p>Parking Guidance is deactivated. Possible causes are:</p> <ul style="list-style-type: none"> <li>• the vehicle is skidding.</li> <li>• the sensors are dirty.</li> <li>• a malfunction has occurred.</li> </ul> <p>A warning tone also sounds.</p> <p>► Reactivate Parking Guidance later (▷ page 155).</p> <p>If the parking space symbol does not appear in the multifunction display at speeds below 19 mph (30 km/h):</p> <p>► Clean the sensors (▷ page 255).</p> <p>► Restart the engine.</p> <p>If the parking space symbol still does not appear in the multifunction display at speeds below 19 mph (30 km/h):</p> <p>► Visit a qualified specialist workshop.</p> <p>Parking Guidance has been deactivated because you are no longer following the recommended path.</p> <p>► Park again and, while doing so, observe the display messages in the multifunction display.</p>
Parking Guidance Finished	<p>The vehicle is parked. A warning tone also sounds.</p> <p>The display message disappears automatically.</p>

Display messages	Possible causes/consequences and ► Solutions
Cruise Control Inoperative	Cruise control is defective. A warning tone also sounds. ► Visit a qualified specialist workshop.
Cruise Control --- mph	A condition for activating cruise control has not been fulfilled. You have tried to store a speed below 20 mph (30 km/h), for example. ► If conditions permit, drive faster than 20 mph (30 km/h) and store the speed. ► Check the activation conditions for cruise control (► page 146).

### Tires

#### WARNING

Do not drive with a flat tire. A flat tire affects the ability to steer or brake the vehicle. You may lose control of the vehicle. Continued driving with a flat tire will cause excessive heat build-up and possibly a fire.





#### WARNING



Follow recommended tire inflation pressures.

Do not underinflate tires. Underinflated tires wear excessively and/or unevenly, adversely affect handling and fuel economy, and are more likely to fail from being overheated.







Do not overinflate tires. Overinflated tires can adversely affect handling and ride comfort, wear unevenly, increase stopping distance, and result in sudden deflation (blowout) because they are more likely to become punctured or damaged by road debris, potholes etc.







Display messages	Possible causes/consequences and ► Solutions
Check Tire Pressure Soon	<p> <b>Risk of accident</b></p> <p>The tire pressure loss warning system has detected a significant loss in pressure.</p> <p>A warning tone also sounds.</p> <ul style="list-style-type: none"> <li>► Stop the vehicle without making any sudden steering or braking maneuvers. Pay attention to the traffic conditions as you do so.</li> <li>► Check the tires and, if necessary, change the wheel (▷ page 300).</li> <li>► Check the tire pressures and, if necessary, set them to the correct tire pressure.</li> <li>► Restart the tire pressure loss warning system when the tire pressure is correct (▷ page 283).</li> </ul>
Check Tire Pressure Then Restart Run Flat Indicator	<p>The tire pressure loss warning system generated a display message and has not been restarted since.</p> <ul style="list-style-type: none"> <li>► Set the correct tire pressure in all four tires.</li> <li>► Restart the tire pressure loss warning system (▷ page 283).</li> </ul>
Run Flat Indicator Inoperative	<p>The tire pressure loss warning system is faulty.</p> <ul style="list-style-type: none"> <li>► Visit a qualified specialist workshop.</li> </ul>
Tire pressures will be displayed after driving a few minutes	<p>The tire pressure monitor is measuring the tire pressure.</p> <ul style="list-style-type: none"> <li>► Drive on.</li> </ul> <p>The tire pressures appear in the multifunction display after you have been driving for a few minutes.</p>
Tire Press. Monitor Inoperative	<p>The tire pressure monitor is faulty.</p> <ul style="list-style-type: none"> <li>► Visit a qualified specialist workshop.</li> </ul>
Tire Press. Monitor Inoperative No Wheel Sensors	<p>The wheels mounted do not have a suitable tire pressure sensor. The tire pressure monitor is deactivated.</p> <ul style="list-style-type: none"> <li>► Mount wheels with suitable tire pressure sensors.</li> </ul> <p>The tire pressure monitor is activated automatically after driving for a few minutes.</p>





Display messages	Possible causes/consequences and ► Solutions
Check Tires	<p> <b>Risk of accident</b></p> <p>The tire pressure in one or more tires has dropped significantly. The wheel position is displayed in the multifunction display. A warning tone also sounds.</p> <ul style="list-style-type: none"> <li>► Stop the vehicle without making any sudden steering or braking maneuvers. Pay attention to the traffic conditions as you do so.</li> <li>► Correct the tire pressure (▷ page 284).</li> <li>► If necessary, change a wheel (▷ page 300).</li> </ul>
Caution Tire Malfunction	<p> <b>Risk of accident</b></p> <p>The tire pressure in one or more tires has dropped suddenly. The wheel position is shown in the multifunction display.</p> <ul style="list-style-type: none"> <li>► Stop the vehicle without making any sudden steering or braking maneuvers. Pay attention to the traffic conditions as you do so.</li> <li>► If necessary, change a wheel (▷ page 300).</li> </ul>
Correct Tire Pressure	<p>The tire pressure is too low in at least one of the tires, or the tire pressure difference between the wheels is too great.</p> <ul style="list-style-type: none"> <li>► Check the tire pressures at the next opportunity. If necessary, correct the tire pressure (▷ page 284).</li> <li>► Restart the tire pressure monitor (▷ page 287).</li> </ul>
TirePress. Sensor(s)Missing	<p>There is no signal from the tire pressure sensor of one or several wheels. The pressure of the affected tire is not displayed in the multifunction display.</p> <ul style="list-style-type: none"> <li>► Have the faulty tire pressure sensor replaced at a qualified specialist workshop.</li> </ul>
Tire Press. Monitor Currently Unavail.	<p>Due to a source of radio interference, no signals can be received from the wheel sensors. The tire pressure monitor is temporarily malfunctioning.</p> <ul style="list-style-type: none"> <li>► Drive on. The tire pressure monitor restarts automatically as soon as the problem has been solved.</li> </ul>
 Tire Press. Warning Caution Tire Malfunction	<p> <b>Risk of accident</b></p> <p>The tire pressure in one or more tires has dropped suddenly. A warning tone also sounds.</p> <ul style="list-style-type: none"> <li>► Stop the vehicle without making any sudden steering or braking maneuvers. Pay attention to the traffic conditions as you do so.</li> <li>► If necessary, change a wheel (▷ page 300).</li> </ul>

Display messages	Possible causes/consequences and ► Solutions
 Check Tire Pressure	<p> <b>Risk of accident</b></p> <p>The tire pressure in one or more tires has dropped significantly.</p> <ul style="list-style-type: none"> <li>► Stop the vehicle without making any sudden steering or braking maneuvers. Pay attention to the traffic conditions as you do so.</li> <li>► If necessary, change a wheel (▷ page 300).</li> <li>► Check the tire pressure. If necessary, correct the tire pressure (▷ page 284).</li> </ul>
 Correct Tire Pressure	<p>The tire pressure is too low in at least one of the tires, or the tire pressure difference between the wheels is too great.</p> <ul style="list-style-type: none"> <li>► Check the tire pressures at the next opportunity. If necessary, correct the tire pressure (▷ page 284).</li> </ul>

Vehicle	
Display messages	Possible causes/consequences and ► Solutions
Shift to 'P' or 'N', to Start Engine	<p>You have attempted to start the engine with the transmission in position <b>R</b> or <b>D</b>.</p> <ul style="list-style-type: none"> <li>► Shift the transmission to position <b>P</b> or <b>N</b>.</li> </ul>
P Shift to 'P'	<p>You have attempted to stop the engine with the Start/Stop button while the transmission was not in position <b>P</b>.</p> <ul style="list-style-type: none"> <li>► Shift the transmission to position <b>P</b>.</li> </ul> <p>With the Hold function activated, you have either:</p> <ul style="list-style-type: none"> <li>• opened the driver's door and released the seat belt or</li> <li>• switched off the engine or</li> <li>• opened the hood</li> </ul> <p>A tone may also sound at regular intervals. If you attempt to lock the vehicle, the tone becomes louder.</p> <p>You cannot start the engine.</p> <ul style="list-style-type: none"> <li>► Shift the transmission to position <b>P</b>. You can restart the engine.</li> </ul>
	<p>The trunk lid is open.</p> <ul style="list-style-type: none"> <li>► Close the trunk lid.</li> </ul>



Display messages	Possible causes/consequences and ► Solutions
	<p> <b>Risk of accident</b></p> <p>The hood is open.</p> <ul style="list-style-type: none"> <li>► Pull over and stop the vehicle safely as soon as possible, paying attention to road and traffic conditions.</li> <li>► Apply the parking brake.</li> <li>► Close the hood.</li> </ul>
	<p>At least one door is open.</p> <ul style="list-style-type: none"> <li>► Close all the doors.</li> </ul>
 <p>Lock Seat Backrest Front Left or Lock Seat Backrest Front Right</p>	<p>The driver's or front passenger's seat backrest is not engaged. A warning tone also sounds.</p> <ul style="list-style-type: none"> <li>► Push the backrest back until it engages.</li> </ul>
 <p>Power Steering Malfunction See Operator's Manual</p>	<p> <b>Risk of accident</b></p> <p>The power steering is malfunctioning. You will need to use more force to steer. A warning tone also sounds.</p> <ul style="list-style-type: none"> <li>► Check whether you are able to apply the extra force required.</li> <li>► <b>If you are able to steer safely:</b> carefully drive on to a qualified specialist workshop.</li> <li>► <b>If you are unable to steer safely:</b> do not drive on. Contact the nearest qualified specialist workshop.</li> </ul>
<p>Phone No Service</p>	<p>Your vehicle is outside the network provider's transmitter/receiver range.</p> <ul style="list-style-type: none"> <li>► Wait until the mobile phone operational readiness symbol appears in the multifunction display.</li> </ul>
 <p>Check Washer Fluid</p>	<p>The washer fluid level in the washer fluid reservoir has dropped below the minimum.</p> <ul style="list-style-type: none"> <li>► Add washer fluid (► page 249).</li> </ul>

SmartKey	
Display messages	Possible causes/consequences and ► Solutions
 Key Does Not Belong to Vehicle	You have put the wrong SmartKey in the ignition lock. ► Use the correct SmartKey.
 Take Your Key from Ignition	The SmartKey is in the ignition lock. ► Remove the SmartKey.
 Obtain a New Key	The SmartKey needs to be replaced. ► Visit a qualified specialist workshop.
 Replace Key Battery	The batteries of the KEYLESS-GO key are discharged. ► Change the batteries (► page 69).
 Don't Forget Your Key	The display message is shown for a maximum of 60 seconds and is only a reminder. You have opened the driver's door with the engine switched off. The KEYLESS-GO key is not in the ignition lock. ► Remember to take the KEYLESS-GO key with you when you leave the vehicle.
 Key Not Detected (red display message)	The KEYLESS-GO key is not in the vehicle. A warning tone also sounds. If the engine is switched off, you can no longer lock the vehicle centrally or start the engine. ► Pull over and stop the vehicle safely as soon as possible, paying attention to road and traffic conditions. ► Apply the parking brake. ► Locate the KEYLESS-GO key.
	The KEYLESS-GO key is not detected while the engine is running because there is interference from a strong source of radio waves. A warning tone also sounds. ► Pull over and stop the vehicle safely as soon as possible, paying attention to road and traffic conditions. ► Apply the parking brake. ► Operate the vehicle with the SmartKey in the ignition lock.







Display messages	Possible causes/consequences and ► Solutions
 <p>Key Not Detected(White display message)</p>	<p>The KEYLESS-GO key cannot be detected at present.</p> <ul style="list-style-type: none"> <li>► Change the location of the key with the KEYLESS-GO functions in the vehicle.</li> </ul> <p>If the KEYLESS-GO key is still not detected:</p> <ul style="list-style-type: none"> <li>► Operate the vehicle with the SmartKey in the ignition lock.</li> </ul>
 <p>Key Detect'd In Vehicle</p>	<p>The KEYLESS-GO key has been detected inside the vehicle during locking.</p> <ul style="list-style-type: none"> <li>► Remove the KEYLESS-GO key from the vehicle.</li> </ul>
 <p>Remove 'Start' Button and Insert Key</p>	<p>KEYLESS-GO is temporarily malfunctioning or is defective. A warning tone also sounds.</p> <ul style="list-style-type: none"> <li>► Insert the SmartKey into the ignition lock and turn it to the desired position.</li> <li>► Visit a qualified specialist workshop.</li> </ul>
 <p>Close Doors to Lock Vehicle</p>	<p>At least one door is open. A warning tone also sounds.</p> <ul style="list-style-type: none"> <li>► Close all doors and lock the vehicle again.</li> </ul>

## Warning and indicator lamps in the instrument cluster



## Seat belts

Problem	Possible causes/consequences and ► Solutions
 <p>After starting the engine, the red seat belt warning lamp lights up for six seconds.</p>	<p>The seat belt warning lamp reminds the driver and front passenger to fasten their seat belts.</p> <ul style="list-style-type: none"> <li>► Fasten your seat belt (▷ page 50).</li> </ul>
 <p>After starting the engine, the red seat belt warning lamp lights up. In addition, a warning tone sounds for up to six seconds.</p>	<p> <b>Risk of injury</b></p> <p>The driver's seat belt is not fastened.</p> <ul style="list-style-type: none"> <li>► Fasten your seat belt (▷ page 50). The warning tone ceases.</li> </ul>



Problem	Possible causes/consequences and ► Solutions
 <p>The red seat belt warning lamp lights up after the engine starts, as soon as the driver's or the front-passenger door is closed.</p>	<p> <b>Risk of injury</b></p> <p>The driver or front passenger has not fastened their seat belt.</p> <ul style="list-style-type: none"> <li>► Fasten your seat belt (► page 50). The warning lamp goes out.</li> </ul> <p> <b>Risk of injury</b></p> <p>There are objects on the front-passenger seat.</p> <ul style="list-style-type: none"> <li>► Remove the objects from the front-passenger seat and stow them in a secure place. The warning lamp goes out.</li> </ul>
 <p>The red seat belt warning lamp flashes and an intermittent audible warning sounds.</p>	<p> <b>Risk of injury</b></p> <p>The driver or front passenger has not fastened their seat belt. In addition, you are driving faster than 15 mph (25 km/h) or you have briefly driven faster than 15 mph (25 km/h).</p> <ul style="list-style-type: none"> <li>► Fasten your seat belt (► page 50). The warning lamp goes out and the intermittent warning tone ceases.</li> </ul> <p> <b>Risk of injury</b></p> <p>There are objects on the front-passenger seat. In addition, you are driving faster than 15 mph (25 km/h) or you have briefly driven faster than 15 mph (25 km/h).</p> <ul style="list-style-type: none"> <li>► Remove the objects from the front-passenger seat and stow them in a secure place. The warning lamp goes out and the intermittent warning tone ceases.</li> </ul>





## Safety systems











Problem	Possible causes/consequences and ► Solutions
<p> (USA only)</p> <p> (Canada only)</p> <p>The red brake system warning lamp comes on while the engine is running. A warning tone also sounds.</p>	<p> <b>Risk of accident</b></p> <p>There is not enough brake fluid in the brake fluid reservoir.</p> <ul style="list-style-type: none"> <li>► Pull over and stop the vehicle safely as soon as possible, paying attention to road and traffic conditions. Do not continue driving under any circumstances.</li> <li>► Apply the parking brake.</li> <li>► Consult a qualified specialist workshop immediately.</li> <li>► Observe the additional display messages in the multifunction display.</li> </ul> <p>Do not add brake fluid. This does not correct the malfunction.</p>





 **WARNING**







Driving with the brake warning lamp illuminated can result in an accident. Have your brake system checked immediately if the brake warning lamp stays on. Do not add brake fluid before checking the brake system.

Overfilling the brake fluid reservoir can result in spilling brake fluid on hot engine parts and the brake fluid catching fire. You can be seriously burned.

Problem	Possible causes/consequences and ► Solutions
 <p>The yellow ABS warning lamp is lit while the engine is running.</p>	<p> <b>Risk of accident</b></p> <p>ABS (Anti-lock Brake System) is deactivated due to a malfunction. BAS (Brake Assist), ESP® (Electronic Stability Program), the HOLD function and hill start assist are therefore also deactivated, for example.</p> <p>The brake system continues to function normally, but without the functions listed above. The wheels could therefore lock if you brake hard, for example.</p> <ul style="list-style-type: none"> <li>► Observe the additional display messages in the multifunction display.</li> <li>► Drive on carefully.</li> <li>► Visit a qualified specialist workshop.</li> </ul> <p>If the ABS control unit is faulty, there is also a possibility that other systems, such as the navigation system or the automatic transmission, will not be available.</p>
 <p>The yellow ABS warning lamp is lit while the engine is running.</p>	<p> <b>Risk of accident</b></p> <p>ABS is temporarily unavailable. BAS, ESP®, EBD (electronic brake force distribution), the HOLD function, hill start assist are therefore also deactivated, for example.</p> <p>Self-diagnosis is not yet complete or the on-board voltage may be insufficient, for example.</p> <p>The brake system continues to function normally, but without the functions listed above. The wheels could therefore lock if you brake hard, for example.</p> <p>ATTENTION ASSIST is deactivated.</p> <ul style="list-style-type: none"> <li>► Carefully drive a short distance on a suitable stretch of road, making slight steering movements at a speed above 12 mph (20 km/h).</li> </ul> <p>The functions mentioned above are available again when the warning lamp goes out.</p> <p>If the warning lamp is still on:</p> <ul style="list-style-type: none"> <li>► Observe the additional display messages in the multifunction display.</li> <li>► Drive on carefully.</li> <li>► Visit a qualified specialist workshop.</li> </ul>

Problem	Possible causes/consequences and ► Solutions
 <p>The yellow ABS warning lamp is lit while the engine is running. A warning tone also sounds.</p>	<p> <b>Risk of accident</b></p> <p>EBD is faulty. Therefore, ABS, BAS, ESP<sup>®</sup>, the HOLD function and hill start assist are unavailable, for example.</p> <p>The brake system continues to function normally, but without the functions listed above. The wheels could therefore lock if you brake hard, for example.</p> <p>ATTENTION ASSIST is deactivated.</p> <ul style="list-style-type: none"> <li>► Observe the additional display messages in the multifunction display.</li> <li>► Drive on carefully.</li> <li>► Visit a qualified specialist workshop.</li> </ul>
<p> (USA only)</p> <p> (Canada only)</p> <p>  </p> <p>The red brake warning lamp, the yellow ESP<sup>®</sup> and ESP<sup>®</sup> OFF warning lamps and the yellow ABS warning lamp are lit while the engine is running.</p>	<p> <b>Risk of accident</b></p> <p>ABS and ESP<sup>®</sup> are faulty. Therefore, BAS, EBD, the HOLD function and hill start assist are also unavailable, for example.</p> <p>The brake system continues to function normally, but without the functions listed above. The wheels could therefore lock if you brake hard, for example.</p> <p>ATTENTION ASSIST is deactivated.</p> <ul style="list-style-type: none"> <li>► Observe the additional display messages in the multifunction display.</li> <li>► Drive on carefully.</li> <li>► Visit a qualified specialist workshop.</li> </ul>
<p></p> <p>The yellow ESP<sup>®</sup> warning lamp flashes while the vehicle is in motion.</p>	<p> <b>Risk of accident</b></p> <p>ESP<sup>®</sup> or traction control has intervened because there is a risk of skidding or at least one wheel has started to spin.</p> <p>Cruise control is deactivated.</p> <ul style="list-style-type: none"> <li>► When pulling away, only depress the accelerator pedal as far as necessary.</li> <li>► Ease off the accelerator pedal while the vehicle is in motion.</li> <li>► Adapt your driving style to suit the road and weather conditions.</li> <li>► Do not deactivate ESP<sup>®</sup>.</li> </ul> <p>For exceptions, see: (&gt; page 60).</p>





Problem	Possible causes/consequences and ► Solutions
 <p>The yellow ESP<sup>®</sup> OFF warning lamp is lit while the engine is running.</p>	<p> <b>Risk of accident</b></p> <p>ESP<sup>®</sup> is deactivated. ESP<sup>®</sup> will not stabilize the vehicle if it starts to skid or if a wheel starts to spin.</p> <ul style="list-style-type: none"> <li>► Reactivate ESP<sup>®</sup>. For exceptions, see: (► page 60).</li> <li>► Adapt your driving style to suit the road and weather conditions.</li> </ul> <p>If ESP<sup>®</sup> cannot be activated:</p> <ul style="list-style-type: none"> <li>► Have ESP<sup>®</sup> checked at a qualified specialist workshop.</li> </ul>
<p><b>SPORT</b></p> <p>AMG vehicles only: The yellow SPORT handling mode warning lamp is lit while the engine is running.</p>	<p> <b>Risk of accident</b></p> <p>SPORT handling mode is activated. ESP<sup>®</sup> only stabilizes the vehicle in extreme situations. ESP<sup>®</sup> intervention may not be able to provide sufficient assistance in such situations and the vehicle may start to skid.</p> <ul style="list-style-type: none"> <li>► Reactivate ESP<sup>®</sup>. Exceptions: (► page 60).</li> </ul> <p>If ESP<sup>®</sup> cannot be activated:</p> <ul style="list-style-type: none"> <li>► Have ESP<sup>®</sup> checked at a qualified specialist workshop.</li> </ul>
 <p>The yellow ESP<sup>®</sup> and ESP<sup>®</sup> OFF warning lamps are lit while the engine is running.</p>	<p> <b>Risk of accident</b></p> <p>ESP<sup>®</sup>, BAS, the HOLD function and hill start assist are unavailable due to a malfunction. ESP<sup>®</sup> will not stabilize the vehicle if it starts to skid or if a wheel starts to spin.</p> <p>The brake system continues to function normally, but without the functions listed above.</p> <p>ATTENTION ASSIST is deactivated.</p> <ul style="list-style-type: none"> <li>► Observe the additional display messages in the multifunction display.</li> <li>► Drive on carefully.</li> <li>► Visit a qualified specialist workshop.</li> </ul>

Problem	Possible causes/consequences and ► Solutions
 <p>The yellow ESP<sup>®</sup> and ESP<sup>®</sup> OFF warning lamps are lit while the engine is running.</p>	<p> <b>Risk of accident</b></p> <p>ESP<sup>®</sup>, BAS, the HOLD function and hill start assist are temporarily unavailable.</p> <p>ESP<sup>®</sup> will not stabilize the vehicle if it starts to skid or if a wheel starts to spin.</p> <p>Self-diagnosis is not yet complete.</p> <p>The brake system continues to function normally, but without the functions listed above. The wheels could therefore lock if you brake hard, for example.</p> <p>ATTENTION ASSIST is deactivated.</p> <ul style="list-style-type: none"> <li>► Carefully drive a short distance on a suitable stretch of road, making slight steering movements at a speed above 12 mph (20 km/h).</li> </ul> <p>The functions mentioned above are available again when the warning lamp goes out.</p> <p>If the warning lamp is still on:</p> <ul style="list-style-type: none"> <li>► Observe the additional display messages in the multifunction display.</li> <li>► Drive on carefully.</li> <li>► Visit a qualified specialist workshop.</li> </ul>
<p> (USA only)</p> <p> (Canada only)</p> <p>The red brake system warning lamp comes on while the vehicle is moving. A warning tone also sounds.</p>	<p>You are driving with the parking brake applied.</p> <ul style="list-style-type: none"> <li>► Release the parking brake.</li> </ul> <p>The warning lamp goes out and the warning tone ceases.</p>
 <p>The red SRS warning lamp is lit while the engine is running.</p>	<p> <b>Risk of injury</b></p> <p>The restraint systems are malfunctioning. The air bags or ETDs may either be triggered unintentionally or, in the event of an accident, not be triggered at all.</p> <ul style="list-style-type: none"> <li>► Drive on carefully.</li> <li>► Visit a qualified specialist workshop immediately.</li> </ul>

 **WARNING**



In the event a malfunction of the SRS is indicated as outlined above, the SRS may not be operational.

For your safety, we strongly recommend that you contact an authorized Mercedes-Benz Center immediately to have the system checked. Otherwise the SRS may not be activated when needed in an accident, which could result in serious or fatal injury, or it might deploy unexpectedly and unnecessarily which could also result in injury.

Engine	
Problem	Possible causes/consequences and ► Solutions
 <p>The yellow Check Engine warning lamp lights up while the engine is running.</p>	<p>There may be a malfunction, for example:</p> <ul style="list-style-type: none"> <li>• in the engine management</li> <li>• in the fuel injection system</li> <li>• in the exhaust system</li> <li>• in the ignition system</li> <li>• in the fuel system</li> </ul> <p>The emission limit values may be exceeded and the engine may be running in emergency mode.</p> <p>► Have the vehicle checked as soon as possible at a qualified specialist workshop.</p> <p><b>i</b> In some states, you must immediately visit a qualified specialist workshop as soon as the yellow Check Engine warning lamp lights up. This is due to the legal requirements in effect in these states. If in doubt, check whether such legal regulations apply in the state in which you are currently driving.</p>
 <p>The yellow reserve fuel warning lamp flashes while the vehicle is in motion. In addition, the  Check Engine warning lamp may light up.</p>	<p>The fuel system pressure is too low. The fuel filler cap is not closed correctly or the fuel system is leaking.</p> <p>► Observe the additional display messages in the multifunction display.</p> <p>► Check that the fuel filler cap is correctly closed.</p> <p>► <b>If the fuel filler cap is not correctly closed:</b> close the fuel filler cap.</p> <p>► <b>If the fuel filler cap is closed:</b> visit a qualified specialist workshop.</p>
 <p>The yellow reserve fuel warning lamp lights up while the engine is running.</p>	<p>The fuel level has dropped into the reserve range.</p> <p>► Refuel at the nearest gas station.</p>

Problem	Possible causes/consequences and ► Solutions
 <p>The red coolant warning lamp lights up while the engine is running and the coolant temperature gauge is at the start of the scale.</p>	<p>The temperature sensor for the coolant temperature gauge is defective.</p> <p>The coolant temperature is no longer being monitored. There is a risk of engine damage if the coolant temperature is too high.</p> <ul style="list-style-type: none"><li>► Pull over and stop the vehicle safely and switch off the engine, paying attention to road and traffic conditions. Do not continue driving under any circumstances.</li><li>► Apply the parking brake.</li><li>► Consult a qualified specialist workshop.</li></ul>



Problem	Possible causes/consequences and ► Solutions
 <p>The red coolant warning lamp comes on while the engine is running.</p>	<p>The coolant level is too low.</p> <p>If the coolant level is correct, the airflow to the engine radiator may be blocked or the electric engine radiator fan may be malfunctioning.</p> <p>The coolant is too hot and the engine is no longer being cooled sufficiently.</p> <ul style="list-style-type: none"> <li>► Observe the additional display messages in the multifunction display.</li> <li>► Pull over and stop the vehicle safely and switch off the engine, paying attention to road and traffic conditions.</li> <li>► Allow the engine and coolant to cool.</li> <li>► Check the coolant level and add coolant (▷ page 248). Observe the warning notes.</li> <li>► If you need to add coolant more often than usual, have the engine coolant system checked.</li> <li>► Make sure that the air supply to the engine radiator is not blocked, e.g. by snow, slush or ice.</li> <li>► At coolant temperatures under 248 °F (120 °C), drive to the next qualified specialist workshop.</li> <li>► Avoid subjecting the engine to heavy loads, e.g. driving in mountainous terrain, and start/stop traffic.</li> </ul>
 <p>The red coolant warning lamp comes on while the engine is running. A warning tone also sounds.</p>	<p>The coolant temperature has exceeded 248 °F (120 °C). The airflow to the engine radiator may be blocked or the coolant level may be too low.</p> <p>The engine is not being cooled sufficiently and may be damaged.</p> <ul style="list-style-type: none"> <li>► Observe the additional display messages in the multifunction display.</li> <li>► Pull over and stop the vehicle safely and switch off the engine, paying attention to road and traffic conditions.</li> <li>► Allow the engine and coolant to cool.</li> <li>► Check the coolant level and add coolant (▷ page 248). Observe the warning notes.</li> <li>► If you need to add coolant more often than usual, have the engine coolant system checked.</li> <li>► Make sure that the air supply to the engine radiator is not blocked, e.g. by snow, slush or ice.</li> <li>► At coolant temperatures under 248 °F (120 °C), drive to the next qualified specialist workshop.</li> <li>► Avoid subjecting the engine to heavy loads, e.g. driving in mountainous terrain, and start/stop traffic.</li> </ul>

 **WARNING**

Driving when your engine is overheated can cause some fluids which may have leaked into the engine compartment to catch fire. You could be seriously burned.

Steam from an overheated engine can cause serious burns which can occur just by opening the engine hood. Stay away from the engine if you see or hear steam coming from it.

Stop the vehicle in a safe location away from other traffic. Turn off the engine, get out of the vehicle and do not stand near the vehicle until the engine has cooled down.

-  If the coolant temperature is over 248 °F (120 °C), do not continue driving. The engine will otherwise be damaged.

**Tires****Problem****Possible causes/consequences and ► Solutions**

USA only:  
The yellow tire pressure monitor warning lamp (pressure loss/malfunction) is lit.  
Canada only:  
The yellow tire pressure monitor warning lamp (pressure loss) is lit.

 **Risk of accident**

The tire pressure monitor has detected a loss of pressure in at least one of the tires.

- Stop the vehicle without making any sudden steering or braking maneuvers. Pay attention to the traffic conditions as you do so.
- Observe the additional display messages in the multifunction display.
- Check the tire pressure. If necessary, correct the tire pressure (▷ page 284).
- If necessary, change a wheel (▷ page 300).



USA only:  
The yellow tire pressure monitor warning lamp (pressure loss/malfunction) flashes for approximately one minute and then remains lit.

The tire pressure monitor is faulty.

- Observe the additional display messages in the multifunction display.
- Visit a qualified specialist workshop.

 **WARNING**

Each tire, including the spare (if provided), should be checked at least once every two weeks when cold and inflated to the pressure recommended by the vehicle manufacturer on the Tire and Loading Information placard on the driver's side B-pillar or the tire pressure label on the inside of the fuel filler flap. If your vehicle has tires of a different size than the size indicated on the Tire and Loading Information placard or, if available, the tire pressure label, you should determine the proper tire pressure for those tires.

As an added safety feature, your vehicle has been equipped with a tire pressure monitoring system (TPMS) that illuminates a low tire pressure indicator lamp when one or more of your tires are significantly underinflated. Accordingly, when the low tire pressure telltale illuminates, you should stop and check your tires as soon as possible, and inflate them to the proper pressure. Driving on a significantly underinflated tire causes the tire to overheat and can lead to tire failure. Underinflation also reduces fuel efficiency and tire tread life, and may affect the vehicle's handling and stopping ability. Please note that the TPMS is not a substitute for proper tire maintenance, and it is the driver's responsibility to maintain correct tire pressure, even if underinflation has not reached the level to trigger illumination of the TPMS low tire pressure indicator lamp.

USA only:

Your vehicle has also been equipped with a TPMS malfunction indicator to indicate when the system is not operating properly. The TPMS malfunction indicator is combined with the low tire pressure telltale. When the system detects a malfunction, the indicator lamp will flash for approximately one minute and then remain continuously illuminated. This sequence will be repeated every time the vehicle is started as long as the malfunction exists. When the malfunction indicator is illuminated, the system may not be able to detect or signal low tire pressure as intended.

TPMS malfunctions may occur for a variety of reasons, including the installation of incompatible replacement or alternate tires or wheels on the vehicle that prevent the TPMS from functioning properly. Always check the TPMS malfunction telltale after replacing one or more tires or wheels on your vehicle to ensure that the replacement or alternate tires and wheels allow the TPMS to continue to function properly.



Useful information .....	224
Loading guidelines .....	224
Stowage areas .....	224
Features .....	228

### Useful information

- i** This Operator's Manual describes all models and all standard and optional equipment of your vehicle available at the time of publication of the Operator's Manual. Country-specific differences are possible. Please note that your vehicle may not be equipped with all features described. This also applies to safety-related systems and functions.
- i** Please read the information on qualified specialist workshops (▷ page 23).

### Loading guidelines

#### WARNING

Always fasten items being carried as securely as possible using fastening materials appropriate for the weight and size of the load.

In an accident, during hard braking or sudden maneuvers, loose items will be thrown around inside the vehicle. This can cause injury to vehicle occupants unless the items are securely fastened in the vehicle.

To help avoid personal injury during a collision or sudden maneuver, exercise care when transporting cargo. Do not pile luggage or cargo higher than the seat backrests.

The trunk is the preferred place to carry objects. Do not place anything on the rear-window shelf.

Never drive a vehicle with the trunk open. Deadly carbon monoxide (CO) gases may enter vehicle interior resulting in unconsciousness and death.

The handling characteristics of a laden vehicle are dependent on the distribution of the load within the vehicle. For this reason, you should observe the following notes when transporting a load:

- when transporting a load, never exceed the maximum permissible gross vehicle weight

or the gross axle weight rating of the vehicle (including occupants). The values are specified on the vehicle identification plate on the B-pillar of the driver's door.

- position heavy loads as far forwards as possible and as low down in the trunk as possible.
- position heavy loads as far forwards as possible and as low down in the trunk as possible.
- the load must not protrude above the upper edge of the seat backrests.
- always place the load against the rear or front seat backrests. Make sure that the seat backrests are securely locked into place.
- always place the load behind unoccupied seats if possible.
- secure the load with sufficiently strong and wear-resistant tie-downs. Pad sharp edges for protection.

### Stowage areas

#### Stowage space

#### Important safety notes

#### WARNING

To help avoid personal injury during a collision or sudden maneuver, exercise care when storing objects in the vehicle. Put luggage or cargo in the trunk if possible.

Do not pile luggage or cargo higher than the seat backrests.

Keep compartment lids closed. This will help to prevent stored objects from being thrown about and injuring vehicle occupants during

- braking
- vehicle maneuvers
- an accident

## Stowage compartments in the front

### Glove box

- i** The glove box can be cooled (> page 121).

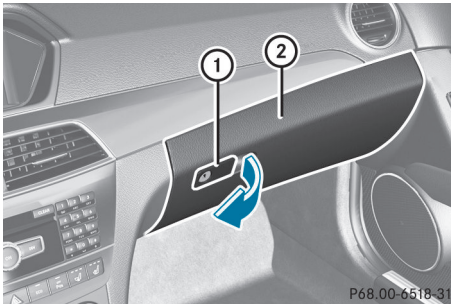

- ▶ **To open:** pull handle ① and open glove box flap ②.
- ▶ **To close:** fold glove box flap ② upwards until it engages.

The glove box can only be locked and unlocked using the mechanical key.

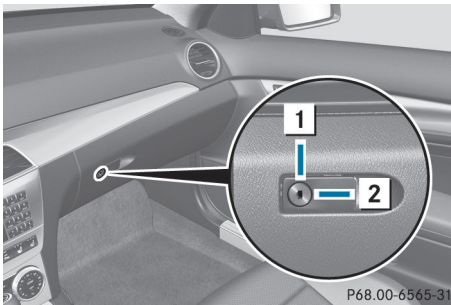

- ▶ **To lock:** insert the mechanical key into the lock and turn it 90° clockwise to position ②.
- ▶ **To unlock:** insert the mechanical key into the lock and turn it 90° counter-clockwise to position ①.

### Stowage compartment under the armrest

- i** Depending on the vehicle's equipment, a USB connection and an AUX IN connection or a Media Interface are installed in the stowage compartment. A Media Interface is a universal interface for mobile audio

equipment, e.g. for an iPod® or MP3 player (see the separate COMAND operating instructions).

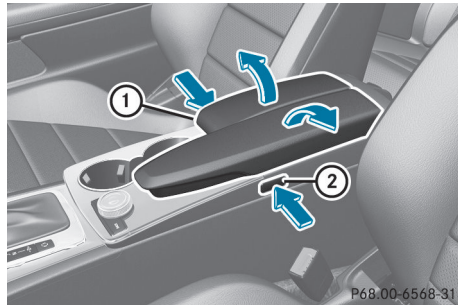

- ▶ **To open:** press left-hand button ② or right-hand button ①. The stowage compartment opens.

### Parcel nets

#### **⚠ WARNING**

Parcel nets are intended for storing light-weight items only, such as road maps, mail, etc.

Heavy objects, objects with sharp edges, or fragile objects may not be transported in the parcel nets. In an accident, during hard braking, or sudden maneuvers, they could be thrown around inside the vehicle and cause injury to vehicle occupants.

Parcel nets cannot protect transported goods in the event of an accident.

Parcel nets are located in the front-passenger footwell and on the left-hand side of the trunk.

### Rear bench seat through-loading feature

### Important safety notes

#### **⚠ WARNING**

When expanding the cargo volume, always fold the seat backrests fully forward.

Unless you are transporting cargo, the seat backrests must remain properly locked in the upright position.

In an accident, during hard braking or sudden maneuvers, loose items will be thrown around inside the vehicle. This can cause injury to vehicle occupants unless the items are securely fastened in the vehicle.

Always use the cargo tie-down rings.

The left-hand and right-hand rear seat backrests can be folded down separately to increase the trunk capacity.

### Folding the seat backrest forward



**i** Vehicles with memory function: when you fold one or both parts of the rear seat backrest forwards, the respective front seat moves forward slightly, when necessary, in order to avoid contact.

- ▶ Vehicles without memory function: if necessary, move the driver's or front-passenger seat forwards.
  - ▶ Open the trunk.
  - ▶ Pull right-hand or left-hand rear seat backrest release handle ①.
- The corresponding rear seat backrest is released.

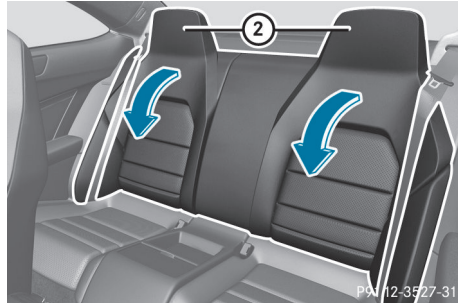

- ▶ Fold rear seat backrest ② forwards.
- ▶ Move the driver's or front-passenger seat back if necessary.

### Folding the seat backrest back

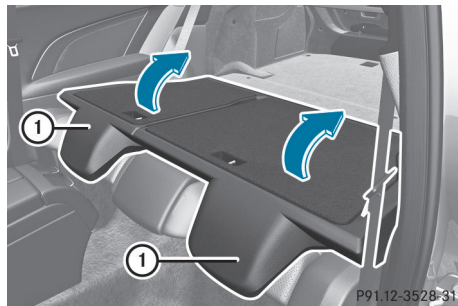

- ▶ Move the driver's or front-passenger seat forward if necessary.
- !** Make sure that the seat belt does not become trapped when folding the rear seat backrest back. Otherwise, it could be damaged.
- ▶ Fold rear seat backrest ① back until it engages.

#### **⚠ WARNING**

Always lock the seat backrest in its upright position when the rear seat bench is occupied, or the extended cargo volume is not in use.

Check for secure locking by pushing and pulling on the seat backrest.

In an accident, during hard braking or sudden maneuvers, loose items will be thrown around



inside the vehicle. This can cause injury to vehicle occupants unless the items are securely fastened in the vehicle. To help avoid personal injury during a collision or sudden maneuver, exercise care when transporting cargo.

- i** You should always engage the rear seat backrests if you do not need the through-loading feature. This will prevent unauthorized access to the trunk from the vehicle interior.
- ▶ Move the driver's or front-passenger seat back if necessary.

### Securing cargo

#### Cargo tie-down rings

Observe the following notes on securing loads:

- secure the load using the cargo tie down rings.
- do not use elastic straps or nets to secure a load, as these are only intended as an anti-slip protection for light loads.
- do not route tie downs across sharp edges or corners.
- pad sharp edges for protection.

There are four cargo tie down rings in the trunk.

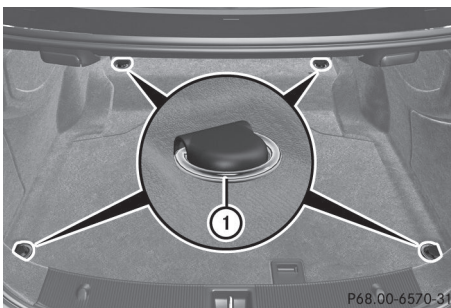

Vehicle with through-loading feature in the rear bench seat

- ① Cargo tie down rings

#### Bag hook

- !** The bag hook can bear a maximum load of 11lbs (5kg) and should not be used to secure a load.

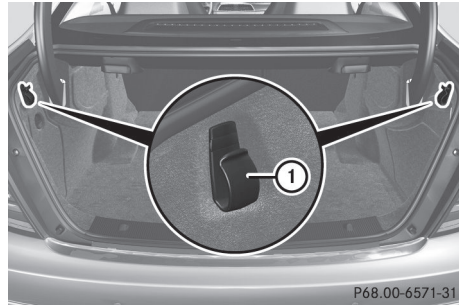

- ① Bag hook

#### Stowage well under the trunk floor

The TIREFIT kit, the vehicle tool kit, etc. are located in the stowage compartment.

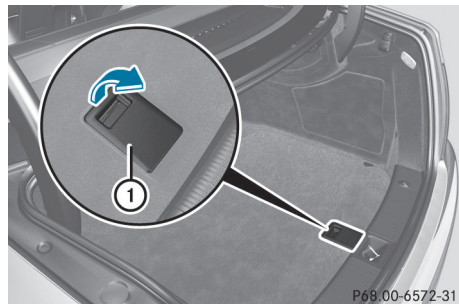

- ▶ **To open:** pull handle ① upwards.

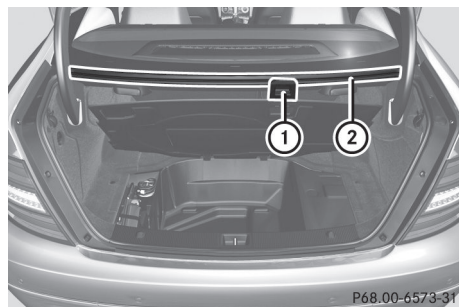

- ▶ Hook handle ① into rain trough ②.

- ❗ Unhook the handle before again before closing the trunk lid and clip it in securely to prevent the handle flap from protruding. Otherwise, you could damage the handle.

### Roof carrier

#### Important safety notes

##### ⚠️ WARNING

Only use roof racks approved by Mercedes-Benz for your vehicle model to avoid damage to the vehicle.

Follow the manufacturer's installation instructions. Otherwise, an improperly attached roof rack system or its load could become detached from the vehicle.

Do not exceed the maximum roof load of 220 lb (100 kg).

Take into consideration that when the roof rack is loaded, the handling characteristics are different from those when operating the vehicle without the roof rack loaded.

- ❗ Mercedes-Benz recommends that you only use roof carriers that have been tested and approved for Mercedes-Benz vehicles. This helps to prevent damage to the vehicle.

Position the load on the roof rack in such a way that the vehicle will not sustain damage even when it is in motion.

Depending on the vehicle equipment, ensure that when the roof carrier is installed you can:

- open the panorama roof with power tilt/sliding panel fully
- open the trunk lid fully

#### Attaching the roof carrier

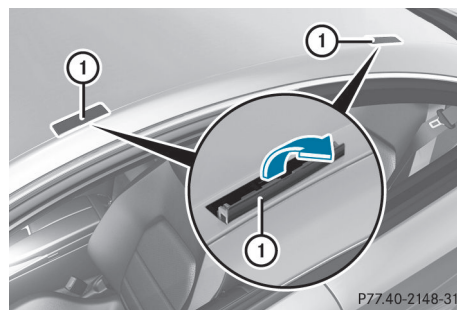

Vehicles with a steel roof

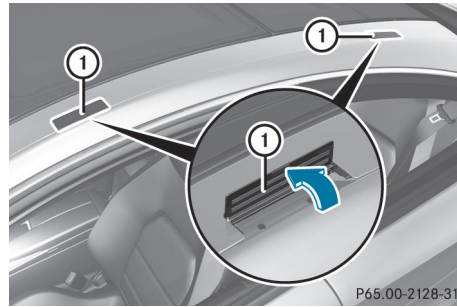

Vehicles with a panorama roof with power tilt/sliding panel

- ▶ Open covers ① carefully in the direction of the arrow.
- ▶ Fold covers ① upwards.
- ▶ Only secure the roof carrier to the anchorage points under covers ①.
- ▶ Observe the manufacturer's installation instructions.

### Features

#### Cup holders

#### Important safety notes

##### ⚠️ WARNING

In order to help prevent spilling liquids on vehicle occupants and/or vehicle equipment, only use containers that fit into the cup holder. Use lids on open containers and do not fill containers to a height where the

contents, especially hot liquids, could spill during braking, vehicle maneuvers, or in an accident. Liquids spilled on vehicle occupants may cause serious personal injury. Liquids spilled on vehicle equipment may cause damage not covered by the Mercedes-Benz Limited Warranty.

When not in use, keep the cup holder closed. An open cup holder may cause injury to you or others when contacted during braking, vehicle maneuvers, or in an accident.

Keep in mind that objects placed in the cup holder may come loose during braking, vehicle maneuvers, or in an accident and be thrown around in the vehicle interior. Objects thrown around in the vehicle interior may cause an accident and/or serious personal injury.

### Cup holder in the front-compartment center console

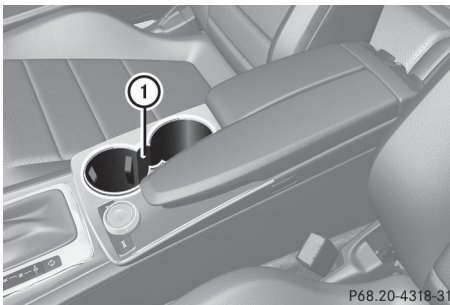

P68.20-4318-31

- ① Cup holders

### Cup holder in the rear storage box

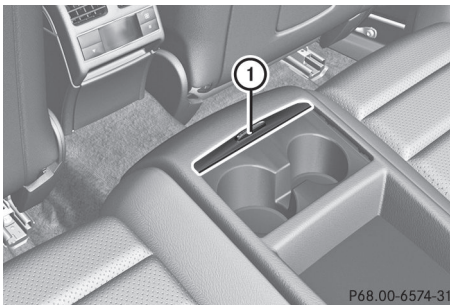

P68.00-6574-31

- ▶ **To open:** slide cover ① forwards.

### Sun visors

#### Overview of sun visors

#### WARNING

Do not use the vanity mirror while driving. Keep the vanity mirrors in the sun visors closed while the vehicle is in motion. Reflected glare can endanger you and others.

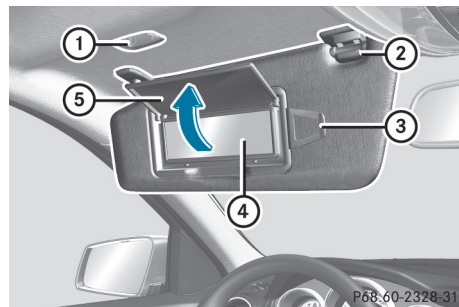

P68.60-2328-31

- ① Mirror light
- ② Bracket
- ③ Retaining clip, e.g. for a car park ticket
- ④ Vanity mirror
- ⑤ Mirror cover

#### Vanity mirror in the sun visor

Mirror light ① only functions if the sun visor is clipped into retainer ② and mirror cover ⑤ has been folded up.

#### Glare from the side

- ▶ Fold down the sun visor.
- ▶ Pull the sun visor out of retainer ②.
- ▶ Swing the sun visor to the side.

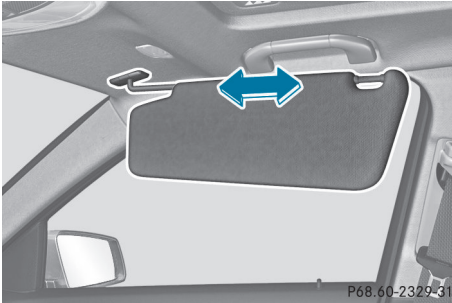

- ▶ Pull or push the sun visor in the direction of the arrow.

### Ashtray

#### Ashtray in the front-compartment center console

- i** You can remove the ashtray insert and use the resulting compartment for stowage.
- !** The stowage space under the ashtray is not heat resistant. Before placing lit cigarettes in the ashtray, make sure that the ashtray is properly engaged. Otherwise, the stowage space could be damaged.

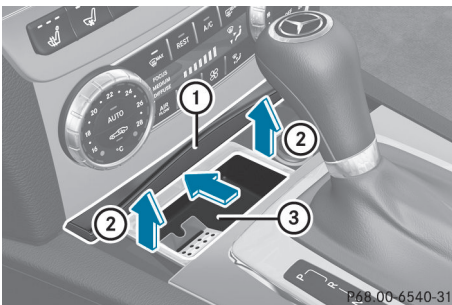

- ▶ **To open:** slide cover ① forwards until it engages.
- ▶ **To remove insert:** hold insert ③ by the ribbing at the sides and lift it up ② and out.

- ▶ **To re-install the insert:** press insert ③ into the holder until it engages.
- ▶ **To close:** press cover ① briefly at the front. The cover moves back.

#### Ashtray in the rear-compartment center console

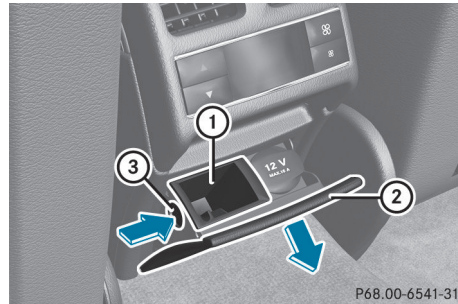

- ▶ **To open:** pull cover ② out by its top edge.
- ▶ **To remove the insert:** press release button ③ and lift the insert up and out.
- ▶ **To install the insert:** put insert ① from above into the holder and press down into the holder until it engages.

### Cigarette lighter

#### **⚠ WARNING**

When leaving the vehicle, always remove the SmartKey from the ignition lock. Always take the SmartKey with you and lock the vehicle. Do not leave children unattended in the vehicle, even if they are secured in a child restraint system, or with access to an unlocked vehicle. A child's unsupervised access to a vehicle could result in an accident and/or serious personal injury. The children could:

- injure themselves on parts of the vehicle
- be seriously or fatally injured through excessive exposure to extreme heat or cold
- injure themselves or cause an accident with vehicle equipment that can be operated



even if the SmartKey is removed from the ignition lock or removed from the vehicle, such as seat adjustment, steering wheel adjustment, or the memory function

If children open a door, they could injure other persons or get out of the vehicle and injure themselves or be injured by following traffic.

Do not expose the child restraint system to direct sunlight. The child restraint system's metal parts, for example, could become very hot, and the child could be burned on these parts.

#### WARNING

Never touch the heating element or sides of the lighter; they are extremely hot. Hold the knob only.

Make sure any children traveling with you do not injure themselves or start a fire with the hot cigarette lighter.

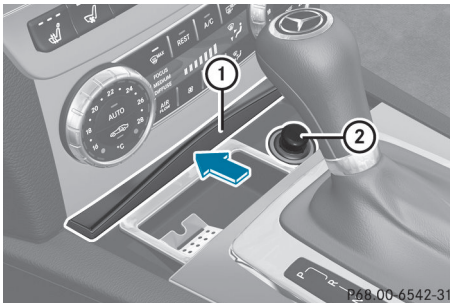

- ▶ Turn the SmartKey to position **2** in the ignition lock.
- ▶ **To open:** slide cover **①** forwards until it engages.
- ▶ Press in cigarette lighter **②**. Cigarette lighter **②** will pop out automatically when the heating element is red-hot.
- ▶ **To close:** press cover **①** briefly at the front. The cover moves back.

## 12 V sockets

### Points to observe before use

The sockets can be used for accessories with a maximum draw of 180 W (15 A).

Accessories include such items as lamps or chargers for mobile phones.

If you use the sockets for long periods when the engine is switched off, the battery may discharge.

- ▶ Turn the SmartKey to position **1** in the ignition lock.

- i** An emergency cut-out ensures that the on-board voltage does not drop too low. If the on-board voltage is too low, the power to the sockets is automatically cut. This ensures that there is sufficient power to start the engine.

### Socket in the rear-compartment center console

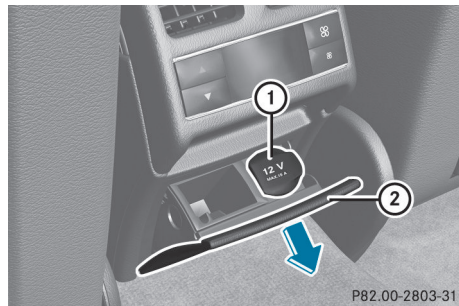

- ▶ Pull cover **②** out by its top edge.
- ▶ Lift up the cover of socket **①**.

## 115 V socket

#### WARNING

The 115 V AC power socket operates on high voltage. Use the 115 V AC power socket in the vehicle with the same caution and care that you would take with power sockets at home. Keep fluids away from the 115 V AC power socket. Do not use liquids or sharp

tools to clean the power socket. Keep the cover of the 115 V AC power socket closed when not in use. Otherwise, you could suffer an electric shock and be seriously or even fatally injured.

**⚠ WARNING**

Any device that you connect must have a suitable plug and meet U.S. standards. Never pull at a cable to disconnect a plug from a 115 V AC power socket. Never use a damaged connection cable. The 115 V AC power socket must never be connected to another 115 V AC power source. Do not use a converter with an earthed plug for the 115 V AC power socket. This could cause serious injury to you and/or other people.

**⚠ WARNING**

If the 115 V AC power socket is damaged or pulled out of the trim, do not use or touch the 115 V AC power socket. The use of a 115 V AC power socket that has been damaged or pulled out of the trim could cause serious injury to you or others.

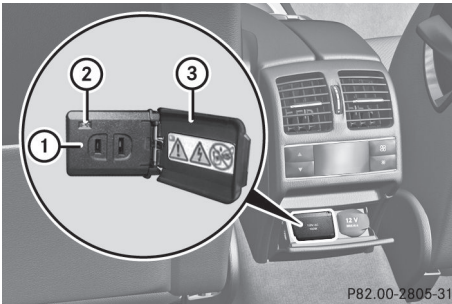

115 V socket ① provides an alternating voltage of 115 V, so that small electronic devices can be connected. These devices, such as game consoles, chargers and laptops, together should not consume more than a maximum of 150 W.

Requirements for operation of these devices:

- the plug of the electronic device must be inserted fully into 115 V power socket ①.
  - the maximum wattage of the device to be connected must not exceed 150 W.
  - the on-board power supply is within a permissible voltage range.
- Open flap ③.
- Insert the plug of the electronic device into 115 V power socket ①. Indicator lamp ② lights up. If indicator lamp ② does not light up, consult the section on malfunctions.
- **To turn off:** disconnect the plug from 115 V power socket ①. Ensure that you do not pull on the cord.

Possible causes of malfunction:

- the on-board power supply is not within a permissible voltage range.
- the temperature of the DC/AC converter is temporarily too high.
- some small electronic devices have a constant nominal power of less than 150 W, but a very high inrush current. These devices will not work. If you connect such a device, 115 V power socket ① will not supply it with power.

If indicator lamp ② still does not light up, contact a specialist workshop.

## mbrace

### Important safety notes

- ❗ A license agreement must exist in order to activate the mbrace service. Ensure that your system is activated and ready for use, and press the  MB Info call button to register. If any of the steps mentioned is not carried out, the system may not be activated.

If you have questions about the activation, contact one of the following telephone assistance services:

- **USA:** Mercedes-Benz Customer Assistance Center under 1-800-FOR-MERcedes (1-800-367-6372) or 1-888-990-9007
- **Canada:** Customer Service at 1-888-923-8367

Shortly after successfully registering with the mbrace service, a user ID and password will be sent to you by mail. You can use this password to log in to the mbrace section under "Owners Online" at <http://www.mbusa.com><sup>12</sup>.

The mbrace system is available if:



- it has been activated and is operational.
  - the corresponding mobile phone network is available for transmitting data to the Customer Center.
  - a service subscription is available.
  - the starter battery is sufficiently charged.
- i** Determining the location of the vehicle on a map is only possible if there is sufficient GPS reception and the vehicle position can be forwarded to the Customer Center.

### The mbrace system

The mbrace system provides different services, e.g.:

- automatic and manual emergency call
- Roadside Assistance call
- MB Info call

To adjust the volume during an mbrace call, proceed as follows:

- ▶ Press the  or  button on the multifunction steering wheel.
- or
- ▶ Use the volume controller of the audio system.

<sup>12</sup> USA only.

<sup>13</sup> USA only.





You can find further information and a description of all available features under "Owners Online" at <http://www.mbusa.com><sup>13</sup>.

### System self-test

After you have switched on the ignition, the system carries out a self-diagnosis.

#### WARNING

A malfunction in the system has been detected if one of the following conditions occurs:

- the indicator lamp in the SOS button does not light up during the system self-diagnosis.
- the indicator lamp in the  Roadside Assistance button does not light up during the system self-diagnosis.
- The indicator lamp in the  information button does not light up during self-diagnosis of the system.
- the indicator lamp in the SOS button,  Roadside Assistance button or  information button continues to be lit red after the system self-diagnosis.
- The **Tele Aid Inoperative** or **Tele Aid Not Activated** message appears in the multifunction display after the system self-test.

If a malfunction is indicated as outlined above, the system may not operate as expected. In the event of an emergency, assistance must be summoned by other means.

Have the system checked at the nearest authorized Mercedes-Benz Center or contact the following service hotlines:

- **USA:** Mercedes-Benz Customer Assistance Center under 1-800-FOR-MERcedes(1-800-367-6372) or 1-888-990-9007
- **Canada:** Customer Service at 1-888-923-8367

## Emergency call

### Important safety notes

**!** A license agreement must exist in order to activate the mbrace service. Ensure that your system is activated and ready for use, and press the  MB Info call button to register. If any of the steps mentioned is not carried out, the system may not be activated.

If you have questions about the activation, contact one of the following telephone assistance services:

- **USA:** Mercedes-Benz Customer Assistance Center under 1-800-FOR-MERCEdes (1-800-367-6372) or 1-888-990-9007
- **Canada:** Customer Service at 1-888-923-8367

An emergency call is dialed automatically if an air bag or Emergency Tensioning Device is triggered.

**i** An mbrace emergency call that has been initiated automatically cannot be terminated by the customer.

An emergency call can also be initiated manually.

As soon as the emergency call has been initiated, the indicator lamp in the SOS button flashes. The **Connecting Call** message appears on the multifunction display.

The audio output is muted.

Once a connection has been established, the **Call Connected** message appears in the multifunction display.

All important information on the emergency is transmitted, for example:

- current location of the vehicle (as determined by the GPS system)
- vehicle identification number
- information on the type of emergency

Shortly after the emergency call has been initiated, a voice connection is automatically established between the Mercedes-Benz

Customer Assistance Center and the vehicle occupants. If the vehicle occupants respond, the Mercedes-Benz Customer Assistance Center attempts to get more information on the emergency.

**i** If there is no response from the vehicle occupants, an ambulance is immediately sent to the vehicle.

### **WARNING**

If the indicator lamp in the SOS button is flashing continuously and there was no voice connection to the Response Center established, then the mbrace system could not initiate an emergency call (e.g. the relevant cellular phone network is not available).

The message **Call Failed** appears in the multifunction display for approximately 10 seconds.

Should this occur, assistance must be summoned by other means.

### Making an emergency call

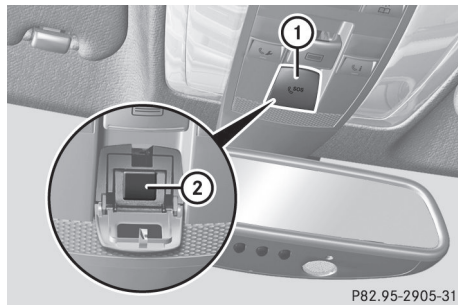

- ▶ **To initiate an emergency call manually:** press cover **1** briefly to open it.
- ▶ Press SOS button **2** briefly. The indicator lamp in SOS button **2** flashes until the emergency call is concluded.



- ▶ Wait for a voice connection to the Mercedes-Benz Customer Assistance Center.
- ▶ After the emergency call is ended, close cover ①.

#### **WARNING**

If you feel at any way in jeopardy when in the vehicle (e.g. smoke or fire in the vehicle, vehicle in a dangerous road location), please do not wait for voice contact after you have pressed the SOS button. Carefully leave the vehicle and move to a safe location. The Response Center will automatically contact local emergency officials with the vehicle's approximate location if they receive an automatic SOS signal and cannot make voice contact with the vehicle occupants.

### Roadside Assistance button

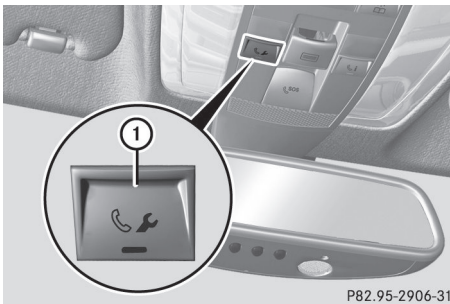

- ▶ Press and hold Roadside Assistance button ① for more than two seconds. This initiates a call to the Mercedes-Benz Customer Assistance Center. The indicator lamp in Roadside Assistance button ① flashes while the call is active. The **Connecting Call** message appears in the multifunction display. The audio output is muted.

If a connection can be established, the **Call Connected** message appears in the multifunction display.

If a cellular phone network is available and there is sufficient GPS reception, the mbrace system transmits data to the Mercedes-Benz Customer Assistance Center, for example:

- current location of the vehicle
- vehicle identification number

- i** The display of the audio system or COMAND shows that an mbrace call is active. During the call, you can change to the navigation menu by pressing the NAVI button on COMAND, for example.

Voice output is not available.

A voice connection is established between the Mercedes-Benz Customer Assistance Center and the vehicle occupants.

- ▶ Describe the type of assistance needed.

The Mercedes-Benz Customer Assistance Center either sends a qualified Mercedes-Benz technician or organizes for your vehicle to be transported to the nearest authorized Mercedes-Benz Center. You may be charged for services such as repair work and/or towing. Further details are available in your mbrace manual.

- i** The mbrace system failed to initiate a Roadside Assistance call if:

- the indicator lamp in Roadside Assistance button ① is flashing continuously.
- no voice connection to the Mercedes-Benz Customer Assistance Center was established.

This may be because the corresponding mobile phone network is not available.

The **Call Failed** message appears in the multifunction display.

- ▶ **To end a call:** press the  button on the multifunction steering wheel.

or

- ▶ Press the corresponding button for ending a phone call on the audio system or on COMAND.

### MB Info call button

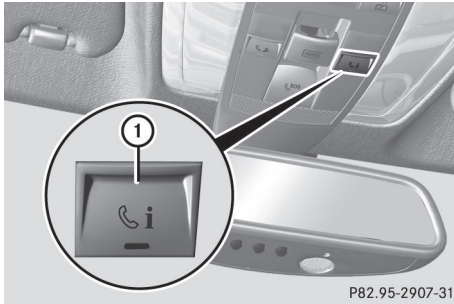

- ▶ Press and hold MB Info call button ① for more than two seconds. This initiates a call to the Mercedes-Benz Customer Assistance Center. The indicator lamp in MB Info call button ① flashes while the connection is being established. The **Connecting Call** message appears in the multifunction display. The audio output is muted.

If a connection can be established, the **Call Connected** message appears in the multifunction display.

If a cellular phone network is available and there is sufficient GPS reception, the mbrace system transmits data to the Mercedes-Benz Customer Assistance Center, for example:

- current location of the vehicle
- vehicle identification number

- ❗ The display of the audio system or COMAND shows that an mbrace call is active. During the call, you can change to the navigation menu by pressing the NAVI button on COMAND, for example.

Voice output is not available.

A voice connection is established between the Mercedes-Benz Customer Assistance Center and the vehicle occupants. You can obtain information on how to operate your vehicle's systems, on the location of the nearest authorized Mercedes-Benz Center,

and on further products and services offered by Mercedes-Benz USA.

Further details on the mbrace system can be found under <http://www.mbusa.com><sup>14</sup>. Log in under "Owners Online".

- ❗ The mbrace system failed to initiate an MB Info call if:

- the indicator lamp in MB Info call button ① is flashing continuously.
- no voice connection to the Mercedes-Benz Customer Assistance Center was established.

This may be because the corresponding mobile phone network is not available.

The **Call Failed** message appears in the multifunction display.

- ▶ **To end a call:** press the  button on the multifunction steering wheel.

or

- ▶ Press the corresponding button for ending a phone call on the audio system or on COMAND.

### Call priority

When service calls are active, e.g. Roadside Assistance or MB Info calls, an emergency call can still be initiated. In this case, an emergency call will take priority and override all other active calls.

The indicator lamp of the respective button flashes until the call is ended. An emergency call can only be terminated by the Mercedes-Benz Customer Assistance Center. All other calls can be ended by pressing the  button on the multifunction steering wheel or the corresponding button for ending a telephone call on the audio system or on COMAND.

- ❗ If an mbrace call is initiated, audio output is muted. The mobile phone is no longer connected to COMAND. However, if you want to use your mobile phone, we

<sup>14</sup> USA only.

recommend that you do this only when the vehicle is stationary and in a safe location.

### Downloading destinations in COMAND

- i** Information on the components and operating principles of COMAND can be found in the separate COMAND operating instructions.
- i** You can only use the Destination Download function if the vehicle is equipped with a navigation system.

Destination Download gives you access to a database with over 15 million points of interest (POIs)/important destinations that can be downloaded onto the navigation system of your vehicle. If you know the destination, you can download the address or obtain the location of points of interest (POIs)/important destinations in the surrounding area.

You are prompted to confirm route guidance to the address entered.

The system calculates the route and subsequently starts the route guidance with the address entered.

- i** If you select **No**, the address can be stored in the address book.
- i** The Destination Download function is available if the corresponding mobile phone network is available and data transfer is possible.

### Route Assistance

This service is part of the mbrace PLUS Package and cannot be purchased separately.

- i** You can also use the Route Assistance function if your vehicle is not equipped with a navigation system.

Within the framework of this service, you receive a professional and reliable form of navigation support without having to leave your vehicle.

<sup>15</sup> USA only.

The customer service representative determines a suitable driving route based on your current vehicle position and the desired destination and guides you live through the current sections of the route.

### Search & Send

"Search & Send" is a destination entry service. You can find further information on "Search & Send" in the separate COMAND operating instructions.

### Vehicle remote opening

If you have unintentionally locked your vehicle (e.g. the SmartKey is still in the vehicle) and a replacement SmartKey is not available, the vehicle can be opened by a Mercedes-Benz Customer Assistance Center. The vehicle can be opened remotely up to four days after the ignition was last switched off.

- ▶ Contact the following service hotlines:
  - **USA:** Mercedes-Benz Customer Assistance Center at 1-800-FOR-MERCEdes (1-800-367-6372) or 1-888-990-9007

- **Canada:** Customer Service at 1-888-923-8367

You will be asked for your password.

- ▶ Return to your vehicle at the time agreed upon with the Mercedes-Benz Customer Assistance Center.
- ▶ Pull on the trunk lid handle for at least 20 seconds until the indicator lamp in the SOS button (▷ page 234) flashes. The **Connecting Call** message appears on the multifunction display.

Alternatively, the vehicle can also be opened via the Internet or an iPhone in the "Owners Online" section using your ID number and password<sup>15</sup>.

- i** Vehicle remote unlocking is only possible if the corresponding mobile phone network is accessible.

The SOS button flashes and the **Connecting Call** message appears in the multifunction display to confirm that the command for vehicle remote unlocking has been received.

If you pull on the trunk handle for more than 20 seconds before receiving authorization for remote unlocking, you must wait 15 minutes before you can pull on the trunk lid handle again.

### Vehicle remote closing

If you forget to lock your vehicle but are no longer in the vicinity of the vehicle, it can be locked for you by the Mercedes-Benz Customer Assistance Center.

The vehicle can be locked remotely up to four days after the ignition was last switched off.

- ▶ Contact the following service hotlines:
  - **USA:** Mercedes-Benz Customer Assistance Center under 1-800-FOR-MERCEdes(1-800-367-6372) or 1-888-990-9007
  - **Canada:** Customer Service at 1-888-923-8367

You will be asked for your PIN.

The next time you are in your vehicle and switch on the ignition, the **Tele Aid Doors Locked by remote control** message appears in the multifunction display.

Alternatively, the vehicle can also be locked via the Internet or an iPhone in the "Owners Online" section using your ID number and password.

- ⓘ The vehicle valet locking feature is available when the relevant mobile phone network is available and data connection is possible.

### Stolen vehicle recovery service

If your vehicle has been stolen:

- ▶ Notify the police.
  - The police will issue a numbered incident report.
- ▶ This number will be forwarded to the Mercedes-Benz Customer Assistance Center together with your PIN.
  - The Mercedes-Benz Customer Assistance Center then attempts to locate the mbrace system. The Mercedes-Benz Customer Assistance Center contacts you and the local law enforcement agency if the vehicle is located. However, only the law enforcement agency is informed of the location of the vehicle.

- ⓘ If the anti-theft alarm system is active for longer than 30 seconds, mbrace automatically informs the Mercedes-Benz Customer Assistance Center.

### Garage door opener

#### Important safety notes

The HomeLink® garage door opener integrated in the rear-view mirror allows you to operate up to three different door and gate systems.

- ⓘ Certain garage door drives are incompatible with the integrated garage door opener. If you have difficulty programming the integrated garage door opener, contact an authorized Mercedes-Benz Center or call one of the following telephone hotlines:
  - **USA:** Mercedes-Benz Customer Assistance Center at 1-800-FOR-MERCEdes
  - **Canada:** Customer Service at 1-800-387-0100

#### WARNING

Before programming the integrated remote control to a garage door opener or gate

operator, make sure people and objects are out of the way of the device to prevent potential harm or damage. When programming a garage door opener, the door moves up or down. When programming a gate operator, the gate opens or closes.

Do not use the integrated remote control with any garage door opener that lacks safety stop and reverse features as required by U.S. federal safety standards (this includes any garage door opener model manufactured before April 1, 1982). A garage door that cannot detect an object - signaling the door to stop and reverse - does not meet current U.S. federal safety standards.

When programming a garage door opener, park vehicle outside the garage.

Do not run the engine while programming the integrated remote control. Inhalation of exhaust gas is hazardous to your health. All exhaust gas contains carbon monoxide (CO), and inhaling it can cause unconsciousness and possible death. All exhaust gas contains carbon monoxide (CO), and inhaling it can cause unconsciousness and possible death.

**i** USA only:

This device complies with Part 15 of the FCC Rules. Operation is subject to the following two conditions:

1. This device may not cause harmful interference, and
2. this device must accept any interference received, including interference that may cause undesired operation.

Any unauthorized modification to this device could void the user's authority to operate the equipment.

FCC ID: CB2HMIHL4

**i** Canada only:

This device complies with RSS-210 of Industry Canada. Operation is subject to the following two conditions:

1. This device may not cause interference, and

2. this device must accept any interference received, including interference that may cause undesired operation of the device.

Any unauthorized modification to this device could void the user's authority to operate the equipment.

IC: 279B-HMIHL4

## Programming the integrated garage door opener on the rear-view mirror

### Programming

**⚠ WARNING**

Only press the button on the integrated garage door opener if there are no persons or objects present within the sweep of the garage door. Persons could otherwise be injured as the door moves.

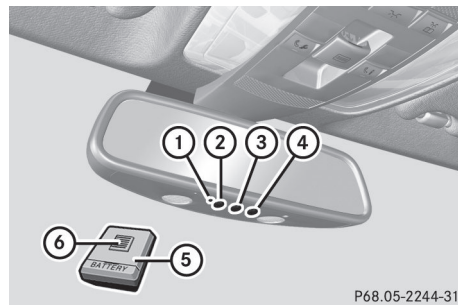

P68.05-2244-31

Integrated garage door opener on the rear-view mirror

Garage door remote control ⑤ is not part of the integrated garage door opener.

- ▶ Before programming for the first time, clear the memory of the integrated garage door opener (▷ page 241).
- ▶ Turn the SmartKey to position **2** in the ignition lock.
- ▶ Press and hold one of the buttons ② to ④ on the integrated garage door opener. After a short time, indicator lamp ① starts flashing yellow.

- i** Indicator lamp ① flashes yellow immediately the first time button ②, ③

or ④ is programmed. If the selected button has already been programmed, indicator lamp ① will only start flashing yellow at a rate of once a second after ten seconds have elapsed.

- ▶ Release button ②, ③ or ④.
- ▶ Point remote control ⑤ at a distance of 2 to 8 inches (5 to 20 cm) at buttons ② to ④ on the rear-view mirror.
- ❗ The required distance between remote control ⑤ and the integrated garage door opener depends on the garage door drive system. Several attempts might be necessary. You should test every position for at least 25 seconds before trying another position.
- ▶ Press and hold button ⑥ on remote control ⑤ until indicator lamp ① lights up green. If indicator lamp ① lights up green or flashes, then programming has been successful.
- ▶ Release button ⑥ on remote control ⑤ for the garage door drive system.

If indicator lamp ① lights up red:

- ▶ Repeat the programming procedure for the corresponding button on the rear-view mirror. When doing so, vary the distance between remote control ⑤ and the rear-view mirror.
- ❗ If the indicator lamp flashes green after successful programming, the garage door system is operating on a rolling code. After programming, you must synchronize the garage door opener integrated in the rear-view mirror with the receiver of the garage door system.

### Synchronizing the rolling code

Your vehicle must be within reach of the garage door or exterior gate drive. Make sure that neither your vehicle nor any persons/objects are present within the sweep of the door or gate.

Observe the safety notes when performing the rolling code synchronization (▷ page 238).

- ▶ Turn the SmartKey to position **2** in the ignition lock.
- ▶ Press the programming button of the door or gate drive (see the door or gate drive operating instructions, e.g. under "Programming of additional remote controls").
- ❗ Usually, you now have 30seconds to initiate the next step.
- ▶ Press previously programmed button ②, ③ or ④ of the integrated garage door opener until the door starts to move. The rolling code synchronization is then complete.

### Notes on programming the remote control

Canadian radio frequency laws require a "break" (or interruption) of the transmission signals after broadcasting for a few seconds. Therefore, these signals may not last long enough for the integrated garage door opener. The signal is not recognized during programming. Comparable with Canadian law, some U.S. garage door openers are designed to "time-out" in the same manner.

Proceed as follows:

- if you live in Canada
- if you have difficulties programming the garage door opener (regardless of where you live) when using the programming steps
- ▶ Press and hold one of buttons ② to ④ on the integrated garage door opener. After a short time, indicator lamp ① starts flashing yellow.
- ▶ Release the button.
- ▶ Press button ⑥ of garage door remote control ⑤ for two seconds, then release it for two seconds.
- ▶ Press button ⑥ again for two seconds.



- ▶ Repeat this sequence on button ⑥ of remote control ⑤ until indicator lamp ① lights up green.  
If indicator lamp ① turns red, repeat the process.
- ▶ Continue with the other programming steps (see above).

### Problems when programming

If you are experiencing problems programming the integrated garage door opener on the rear-view mirror, take note of the following instructions:

- Check the transmitter frequency of garage door drive remote control ⑤. This can usually be found on the back of the remote control.  
The integrated garage door opener is compatible with devices that have units which operate in the frequency range of 280 to 390MHz.
- Replace the batteries in garage door remote control ⑤. This increases the likelihood that garage door remote control ⑤ will transmit a strong and precise signal to the integrated garage door opener in the rear-view mirror.
- When programming, hold remote control ⑤ at varying distances and angles from the button that you are programming. Try various angles at a distance between 2 and 12 inches (5 to 30 cm) or at the same angle but at varying distances.
- If another remote control for the same garage door drive is available, repeat the same programming steps with this remote control. Before performing these steps, make sure that new batteries have been installed in garage door drive remote control ⑤.
- Note that some remote controls only transmit for a limited amount of time (the indicator lamp on the remote control goes

out). Press button ⑥ on remote control ⑤ again before transmission ends.

- Align the antenna cable of the garage door opener unit. This can improve signal reception/transmission.

### Opening/closing the garage door

After it has been programmed, the integrated garage door opener performs the function of the garage door system remote control. Please also read the operating instructions for the garage door system.

- ▶ Turn the SmartKey to position **2** in the ignition lock.
- ▶ Press button ②, ③ or ④ that you have programmed to operate the garage door.  
Garage door system with a fixed code: indicator lamp ① lights up green.  
Garage door system with a rolling code: indicator lamp ① flashes green.

- ① The transmitter will transmit a signal for as long as the button is pressed. The transmission is halted after a maximum of ten seconds and indicator lamp ① flashes yellow. Press button ②, ③ or ④ again if necessary.

### Clearing the memory of the integrated garage door opener on the rear-view mirror

- ▶ Turn the SmartKey to position **2** in the ignition lock.
- ▶ Press buttons ② and ④.  
The indicator lamp lights up yellow.
- ▶ Press and hold buttons ② and ④ until the indicator lamp turns green.
- ① Make sure that you clear the memory of the integrated garage door opener before selling the vehicle.

## Compass

### Calling up the compass

The compass shows the direction in which the vehicle is currently traveling: **N, NE, E, SE, S, SW, W** or **NW**.

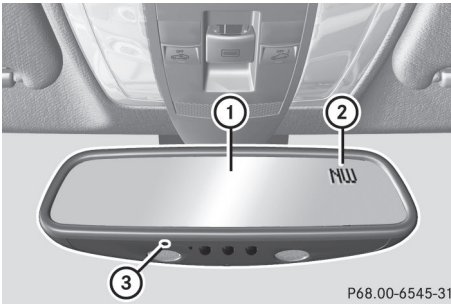

P68.00-6545-31

To obtain a correct display in rear-view mirror ①, the compass must be calibrated and the magnetic field zone must be set.

### Setting the compass

- ▶ Determine your position using the following zone maps.

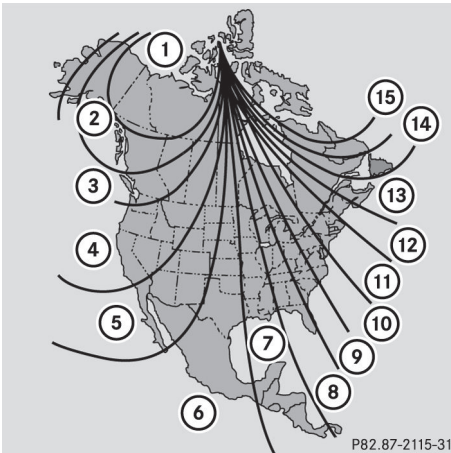

P82.87-2115-31

North America zone map

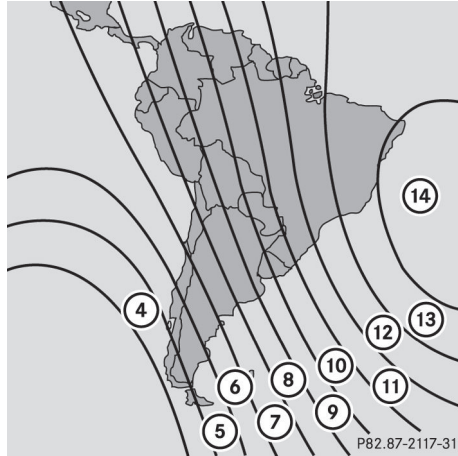

P82.87-2117-31

South America zone map

- ▶ Press a round pin into opening ③ (▷ page 242) for approximately three seconds. The currently selected zone appears in compass display ② (▷ page 242).
- ▶ **To select the zone:** press a round pin into opening ③ (▷ page 242) repeatedly until the desired zone is selected. The zone has been selected when compass display ② (▷ page 242) switches to the compass direction after a few seconds.

### Calibrating the compass

- ▶ Make sure that there is sufficient space for you to drive in a circle without impeding traffic.

In order to calibrate the compass correctly, do the following:

- calibrate the compass in the open and not in the vicinity of steel structures or high-voltage transmission lines.
- switch off electrical consumers such as the climate control, windshield wipers or rear window defroster.
- close all doors and the trunk lid.
- ▶ Switch the ignition on.
- ▶ Press a round pin into opening ③ (▷ page 242) for approximately six



seconds until the **C** symbol appears in compass display ② (▷ page 242).

- ▶ Drive in a full circle at approximately 3 mph (5 km/h) to 6 mph (10 km/h). Once the calibration has been successfully completed, the current direction appears in compass display ② (▷ page 242).

### Floor mat on the driver's side

#### **WARNING**

Whenever you are using a floor mat, make sure there is enough clearance and that the floor mat is securely fastened.

The floor mat should always be securely fastened using the fastening equipment.

Before driving off, check that the floor mat is securely in place and adjust it if necessary. A loose floor mat could slip and hinder proper functioning of the pedals.

Do not place several floor mats on top of each other as this may impair pedal movement.

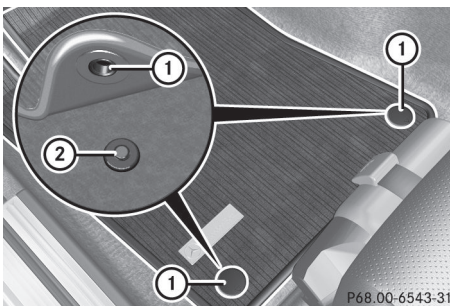

- ▶ Slide the seat backwards.
- ▶ **To install:** place the floor mat in the footwell.
- ▶ Press studs ① onto retainers ②.
- ▶ **To remove:** pull the floor mat off retainers ②.
- ▶ Remove the floor mat.



Useful information .....	246
Engine compartment .....	246
Maintenance .....	250
Care .....	251

## Useful information

- i** This Operator's Manual describes all models and all standard and optional equipment of your vehicle available at the time of publication of the Operator's Manual. Country-specific differences are possible. Please note that your vehicle may not be equipped with all features described. This also applies to safety-related systems and functions.
- i** Please read the information on qualified specialist workshops (▷ page 23).

## Engine compartment

## Hood

## Opening the hood

**⚠ WARNING**

Do not pull the release lever while the vehicle is in motion. Otherwise, the hood could be forced open by passing air flow.

This could cause the hood to come loose and injure you and/or others.

**⚠ WARNING**

Do not open the hood when the engine is overheated. You could be seriously injured. Observe the coolant temperature gauge to determine whether the engine may be overheated. If you see flames or smoke coming from the engine compartment, move away from the vehicle. Wait until the engine has cooled. If necessary, call the fire department.

**⚠ WARNING**

There is a risk of injury if the hood is open, even if the engine is not running. Some engine components can become very hot. To avoid the risk of burns, only touch those components described in the Operator's Manual and observe the relevant safety notes.

**⚠ WARNING**

To avoid injury, stay clear of moving parts when the hood is open and the engine is running.

The radiator fan may continue to run for approximately 30seconds or may even restart after the engine has been switched off. For this reason, you must not reach into the fan rotation area.

**⚠ WARNING**

The engine is equipped with a transistorized ignition system. Because of the high voltage, it is dangerous to touch any components (ignition coils, spark plug sockets, diagnostic socket) of the ignition system:

- with the engine running
- while starting the engine
- when the ignition is switched on and the engine is turned manually

- ▶ Make sure that the windshield wipers are switched off.

**⚠ WARNING**

The windshield wipers and wiper linkage could be set in motion.

When the hood is open, you or others could be injured by the wiper linkage.

Make sure that the windshield wipers are switched off. Remove the SmartKey or make sure that no ignition position has been selected with KEYLESS-GO. All indicator lamps must be off in the instrument panel.

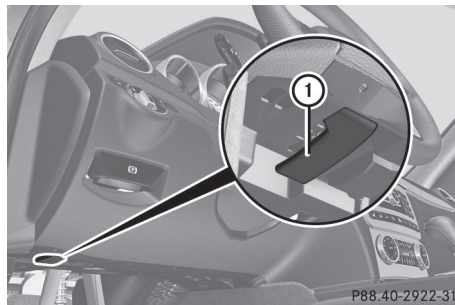

P88.40-2922-31

- ▶ Pull release lever ① for the hood.  
The hood is released.

**!** Make sure that the windshield wipers are not folded away from the windshield. You could otherwise damage the windshield wipers or the hood.

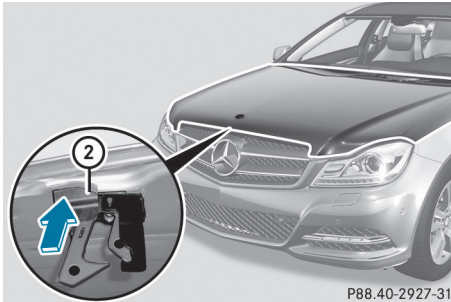

P88.40-2927-31

- ▶ Reach into the gap, pull hood catch handle ② up and lift the hood.  
Once you have lifted the hood about 15 inches (40cm), it is automatically opened the rest of the way and held open by the gas-filled struts.

### Closing the hood

**⚠ WARNING**

When closing the hood, use extreme caution not to catch hands or fingers. Be careful that you do not close the hood on anyone.

Make sure the hood is securely engaged before driving off. Do not continue driving if the hood can no longer engage after an accident, for example. The hood could otherwise come loose while the vehicle is in motion and injure you and/or others.

- ▶ Lower the hood and let it fall from a height of approximately 8 inches (20cm).
- ▶ Check that the hood has engaged properly. If the hood can be raised slightly, it is not properly engaged. Open it again and close it with a little more force.

### Engine oil

#### Notes on the oil level

Depending on the driving style, the vehicle consumes up to 0.9 US qts (0.8 l) of oil over a distance of 600 miles (1,000 km). The oil consumption may be higher than this when the vehicle is new or if you frequently drive at high engine speeds.

Depending on the engine, the oil dipstick may be in a different location.

When checking the oil level:

- park the vehicle on a level surface.
- the engine should be switched off for approximately five minutes if the engine is at normal operating temperature.
- if the engine is not at normal operating temperature, e.g. if the engine was only started briefly: wait about 30 minutes before carrying out the measurement.

#### Checking the oil level using the oil dipstick

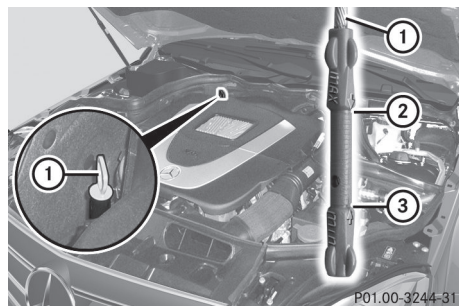

P01.00-3244-31

- ▶ Pull oil dipstick ① out of the dipstick guide tube.
- ▶ Wipe off oil dipstick ①.
- ▶ Slowly slide oil dipstick ① into the guide tube to the stop, and take it out again. If the level is between MIN mark ③ and MAX mark ②, the oil level is correct.
- ▶ If the oil level is at or below MIN mark ③, add 0.55 US qt to 1.1 US qt (0.5 to 1.0 l) of engine oil.

## Adding engine oil

### WARNING

If engine oil comes into contact with hot engine parts, it may ignite and you could burn yourself. Do not spill any engine oil on hot engine parts.

### Environmental note

When adding oil, take care not to spill any. If oil enters the soil or waterways, it is harmful to the environment.

- !** Only use engine oils and oil filters that have been approved for vehicles with a service system. You can obtain a list of the engine oils and oil filters tested and approved in accordance with the Mercedes-Benz Specifications for Service Products at any Mercedes-Benz Service center.

Damage to the engine or exhaust system is caused by the following:

- using engine oils and oil filters that have not been specifically approved for the service system
  - replacing engine oil and oil filters after the interval for replacement specified by the service system has been exceeded
  - using engine oil additives.
- !** Do not add too much oil. adding too much engine oil can result in damage to the engine or to the catalytic converter. Have excess engine oil siphoned off.



Example: engine oil cap

- ▶ Turn cap ① counterclockwise and remove it.
- ▶ Add engine oil.  
If the oil level is at or below the MIN mark on the oil dipstick, add 0.55 US qt to 1.1 US qt (0.5 to 1.0 l) of engine oil.
- ▶ Replace cap ① on the filler neck and turn clockwise.  
Ensure that the cap locks into place securely.
- ▶ Check the oil level again with the oil dipstick (> page 247).

Further information on engine oil (> page 310).

## Checking and adding other service products

### Checking the coolant level

#### WARNING

In order to avoid any potentially serious burns:

- use extreme caution when opening the hood if there are any signs of steam or coolant leaking from the cooling system, or if the coolant temperature display indicates that the coolant is overheated.
- do not remove the pressure cap on the coolant reservoir if the coolant temperature is above 158 °F (70 °C). Allow the engine to cool down before removing the cap. The coolant reservoir contains hot fluid and is under pressure.

- using a rag, slowly turn the cap approximately  $\frac{1}{2}$  turn to relieve excess pressure. If opened immediately, scalding hot fluid and steam will be blown out under pressure.
- do not spill antifreeze on hot engine parts. Antifreeze contains ethylene glycol which may burn if it comes into contact with hot engine parts.

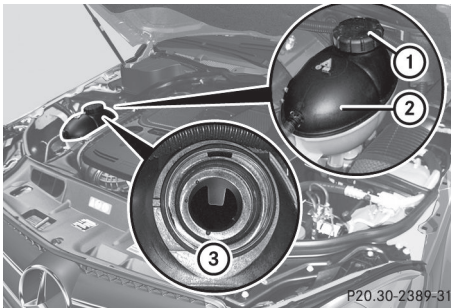

- ▶ Park the vehicle on a level surface. Only check the coolant level when the vehicle is on a level surface and the engine has cooled down.
  - ▶ Turn the SmartKey to position **2** in the ignition lock (▷ page 125). On vehicles with KEYLESS-GO, press the Start/Stop button twice (▷ page 125).
  - ▶ Check the coolant temperature display in the instrument cluster. The coolant temperature must be below 158 °F (70 °C).
  - ▶ Turn the SmartKey to position **0** (▷ page 125) in the ignition lock.
  - ▶ Slowly turn cap ① half a turn counter-clockwise to allow excess pressure to escape.
  - ▶ Turn cap ① further counter-clockwise and remove it. If the coolant is at the level of marker bar ③ in the filler neck when cold, there is enough coolant in coolant expansion tank ②.
- If the coolant level is approximately 0.6 in (1.5 cm) above marker bar ③ in the filler

neck when warm, there is enough coolant in coolant expansion tank ②.

- ▶ If necessary, add coolant that has been tested and approved by Mercedes-Benz.
- ▶ Replace cap ① and turn it clockwise as far as it will go.

For further information on coolant, see (▷ page 312).

### Adding washer fluid to the windshield washer system/headlamp cleaning system

#### WARNING

Washer solvent/antifreeze is highly flammable. Do not spill washer solvent/antifreeze on hot engine parts, because it may ignite and burn. You could be seriously burned.

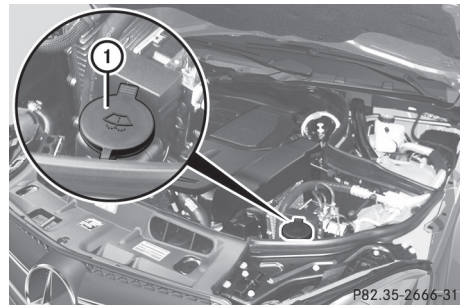

- ▶ **To open:** pull cap ① upwards by the tab.
- ▶ Add the premixed washer fluid.
- ▶ **To close:** press cap ① onto the filler neck until it engages.

The washer fluid reservoir is used for both the windshield washer system and the headlamp cleaning system.

Further information on windshield washer fluid/antifreeze (▷ page 312).

### Brake fluid level

- ! If the brake fluid level in the brake fluid reservoir has fallen to the MIN mark or below, check the brake system



immediately for leaks. Also check the thickness of the brake linings. Visit a qualified specialist workshop immediately.

Do not add brake fluid. This does not correct the malfunction.

Only check the brake fluid level when the vehicle is stationary and on a level surface.

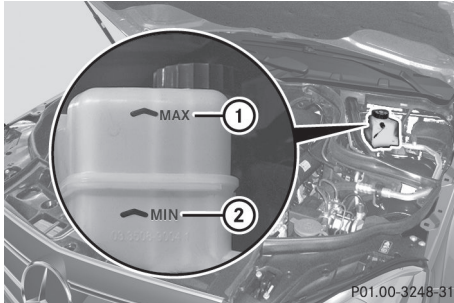

If the brake fluid level is between MIN marking ② and MAX marking ① on the brake fluid reservoir, it is correct.

## Maintenance

### Service interval display

#### Service messages

Information on the type of service and service intervals (see separate Maintenance Booklet).

You can obtain further information from an authorized Mercedes-Benz Center or at <http://www.mbusa.com> (USA only).

The service interval display informs you of the next service due date.

If a service due date has been exceeded, you also hear an acoustic signal.

The multifunction display shows a service message for a few seconds, e.g.

Next service A due in .. days

Service A due

Service A overdue by ... days

The letter indicates which service is due. **A** stands for a minor service and **B** for a major

service. A number or another letter may be displayed after the letter. This figure indicates any necessary additional maintenance work to be performed.

You can obtain further information from an authorized Mercedes-Benz Center.

The service interval display does not take into account any periods of time during which the battery is disconnected.

Maintaining the time-dependent service schedule:



- ▶ Note down the service due date displayed in the multifunction display before disconnecting the battery.

or





- ▶ Subtract the battery disconnection periods from the service date shown on the display after reconnecting the battery.

**i** The service interval display does not provide any information regarding the engine's oil level. Observe the notes on the engine oil level (> page 247).

#### Hiding a service message

- ▶ Press the  or  button on the steering wheel.

#### Displaying service messages

- ▶ Switch on the ignition.
- ▶ Press  or  on the steering wheel to select the **Serv.** menu.
- ▶ Press  or  to select the **ASSYST PLUS** submenu and press  to confirm. The service due date appears in the multifunction display.

#### Please bear the following in mind

##### Resetting service interval display

If the qualified specialist workshop, e.g. a Mercedes-Benz Center, carried out the maintenance work, the service interval display will be reset.



Further information, on maintenance for example, can be obtained at an authorized Mercedes-Benz Center or directly from Mercedes-Benz.

- !** If the service interval display has been reset unintentionally, have the setting corrected at a Mercedes-Benz Center. Have service work carried out as described in the Maintenance Booklet. This may otherwise lead to increased wear and damage to the major assemblies or the vehicle.

### Driving abroad

An extensive Mercedes-Benz Service network is also available in other countries. You can obtain further information from any authorized Mercedes-Benz Center.

## Care

### Notes on care

Regular care of your vehicle is a condition for retaining the quality in the long term.

Use care products and cleaning agents recommended and approved by Mercedes-Benz.

#### WARNING

Many cleaning products can be hazardous. Some are poisonous, others are flammable. Always follow the instructions on the particular container. Always open your vehicle's doors or windows when cleaning the inside.

Never use fluids or solvents that are not designed for cleaning your vehicle. Always lock away cleaning products and keep them out of reach of children.

- !** For cleaning your vehicle, do not use any of the following:
- dry, rough or hard cloths
  - abrasive cleaning agents

- solvents
- cleaning agents containing solvents

Do not scrub.

Do not touch the surfaces or protective films with hard objects, e.g. a ring or ice scraper. You could otherwise scratch or damage the surfaces and protective film.

#### Environmental note

Dispose of empty packaging and cleaning cloths in an environmentally responsible manner.

- !** Do not park the vehicle for an extended period straight after cleaning it, particularly after having cleaned the wheels with wheel cleaner. Wheel cleaners could cause increased corrosion of the brake discs and brake pads/linings. For this reason, you should drive for a few minutes after cleaning. Braking heats the brake discs and the brake pads/linings, thus drying them. The vehicle can then be parked.

### Exterior care

#### Automatic car wash

##### WARNING

Braking efficiency is reduced after washing the vehicle. This could cause an accident. For this reason, you must drive particularly carefully after washing the vehicle until the brakes have dried.

##### WARNING

The vehicle is braked if the HOLD function is activated. Therefore, deactivate the HOLD function before the vehicle is washed in an automatic car wash.

You can wash the vehicle in an automatic car wash from the very start.

- !** Never clean your vehicle in a Touchless Automatic Car Wash as these use special cleaning agents. These cleaning agents can damage the paintwork or plastic parts.

If the vehicle is very dirty, pre-wash it before cleaning it in an automatic car wash.

**!** Make sure that the automatic transmission is in position **N** when washing your vehicle in a tow-through car wash. The vehicle could be damaged if the transmission is in another position.

**!** Make sure that:

- the side windows and the sliding sunroof are fully closed.
- the ventilation/heating is switched off (the OFF button has been pressed).
- the windshield wiper switch is in position **0**.

Otherwise, the vehicle might be damaged.

After using an automatic car wash, wipe off wax from the windshield and the wiper blades. This will prevent smears and reduce wiping noises caused by residue on the windshield.

### Washing by hand

In some countries, washing by hand is only allowed at specially equipped washing bays. Observe the legal requirements in all countries concerned.

- ▶ Do not use hot water and do not wash the vehicle in direct sunlight.
- ▶ Use a soft sponge to clean.
- ▶ Use a mild cleaning agent, such as a car shampoo approved by Mercedes-Benz.
- ▶ Thoroughly hose down the vehicle with a gentle jet of water.
- ▶ Do not point the water jet directly towards the air inlet.
- ▶ Use plenty of water and rinse out the sponge frequently.
- ▶ Rinse the vehicle with clean water and dry thoroughly with a chamois.
- ▶ Do not let the cleaning agent dry on the paintwork.

When using the vehicle in winter, remove all traces of road salt deposits carefully and as soon as possible.

### Power washers

#### WARNING

Do not use power washers with circular-jet nozzles (dirt grinders) to clean your vehicle, in particular the tires. You could otherwise damage the tires and cause an accident.

**!** Always maintain a distance of at least 11.8 in (30 cm) between the vehicle and the power washer nozzle. Information about the correct distance is available from the equipment manufacturer.

Move the power washer nozzle around when cleaning your vehicle.

Do not aim directly at any of the following:

- tires
- door gaps, roof gaps, joints, etc.
- electrical components
- battery
- connectors
- lights
- seals
- trim
- ventilation slots

Damaged seals or electrical components can lead to leaks or failures.

### Cleaning the wheels

**!** Do not use acidic wheel cleaning products to remove brake dust. This could damage wheel bolts and brake components.

**!** Do not park the vehicle for an extended period straight after cleaning it, particularly after having cleaned the wheels with wheel cleaner. Wheel cleaners could cause increased corrosion of the brake discs and brake pads/linings. For this reason, you should drive for a few minutes after cleaning. Braking heats the brake discs and

the brake pads/linings, thus drying them. The vehicle can then be parked.

### Cleaning the paintwork

Scratches, corrosive deposits, areas affected by corrosion and damage caused by inadequate care cannot always be completely repaired. In such cases, visit a qualified specialist workshop.

- ▶ Remove dirt immediately, where possible, while avoiding rubbing too hard.
- ▶ Soak insect remains with insect remover and rinse off the treated areas afterwards.
- ▶ Soak bird droppings with water and rinse off the treated areas afterwards.
- ▶ Remove coolant, brake fluid, tree resin, oils, fuels and greases by rubbing gently with a cloth soaked in petroleum ether or lighter fluid.
- ▶ Use tar remover to remove tar stains.
- ▶ Use silicone remover to remove wax.

#### ! Do not affix:

- stickers
- films
- magnetic plates or similar items

to painted surfaces. You could otherwise damage the paintwork.

If water no longer forms "beads" on the paint surface, use the paint care products recommended and approved by Mercedes-Benz. This is the case approximately every three to five months, depending on the climate conditions and the care product used.

If the dirt has penetrated the paint surface or if the paintwork has become dull, then the paintwork should be cleaned. For cleaning, please use the paint cleaner recommend and approved by Mercedes Benz.

Do not use these care products in the sun or on the hood while the hood is hot.

- ▶ Use a suitable touch-up stick, e.g. MB Touch-Up Stick, to repair slight damage to the paintwork quickly and provisionally.

### Matte finish care

If your vehicle has a clear matte finish, observe the following instructions in order to avoid damage to the paintwork due to incorrect care.

These notes also apply to light alloy wheels with a clear matte finish.

**!** Never polish the vehicle or the light alloy wheels. Polishing causes the finish to shine.

**!** The following may cause the paint to become shiny and thus reduce the matte effect:

- Vigorous rubbing with unsuitable materials.
- Frequent use of car washes.
- Washing the vehicle in direct sunlight.

**!** Never use paint cleaner, buffing or polishing products, or gloss preserver, e.g. wax. These products are only suitable for high-gloss surfaces. Their use on vehicles with matte finish leads to considerable surface damage (shiny, spotted areas). Always have paintwork repairs carried out at a qualified specialist workshop.

**!** Do not use wash programs with a hot wax treatment under any circumstances.

**i** The vehicle should preferably be washed by hand using a soft sponge, car shampoo and plenty of water.

**i** Use only insect remover and car shampoo from the range of recommended and approved Mercedes-Benz care products.

### Cleaning the windows

#### WARNING

Before cleaning the windshield or wiper blades, switch off the windshield wipers and remove the SmartKey from the ignition lock. On vehicles with KEYLESS-GO, press the Start/Stop button repeatedly until all indicator lamps in the instrument cluster have

gone out. The windshield wipers could otherwise move and injure you.

- ❗ Only fold the windshield wipers away from the windshield when vertical. Otherwise, you will damage the hood.
- ▶ Clean the inside and outside of the windows with a damp cloth and a cleaning agent that is recommended and approved by Mercedes-Benz.
- ❗ Do not use dry cloths, abrasive products, solvents or cleaning agents containing solvents to clean the inside of the windows. Do not touch the insides of the windows with hard objects, e.g. an ice scraper or ring. There is otherwise a risk of damaging the windows.
- ❗ Clean the water drainage channels of the windshield and the rear window at regular intervals. Deposits such as leaves, petals and pollen may under certain circumstances prevent water from draining away. This can lead to corrosion damage and damage to electronic components.

### Cleaning the wiper blades

#### WARNING

Before cleaning the windshield or wiper blades, switch off the windshield wipers and remove the SmartKey from the ignition lock. On vehicles with KEYLESS-GO, press the Start/Stop button repeatedly until all indicator lamps in the instrument cluster have gone out. The windshield wipers could otherwise move and injure you.

- ❗ Only fold the windshield wipers away from the windshield when vertical. Otherwise, you will damage the hood.
- ❗ Do not pull the wiper blade. Otherwise, the wiper blade could be damaged.
- ❗ Do not clean wiper blades too often and do not rub them too hard. Otherwise, the

graphite coating could be damaged. This could cause wiper noise.

- ▶ Fold the wiper arms away from the windshield.
- ▶ Carefully clean the wiper blades with a damp cloth.
- ▶ Fold the windshield wipers back again before switching on the ignition.
- ❗ Hold the wiper arm securely when folding back. The windshield could be damaged if the wiper arm smacks against it suddenly.

### Cleaning the exterior lighting

- ❗ Only use cleaning agents or cleaning cloths which are suitable for plastic light lenses. Unsuitable cleaning agents or cleaning cloths could scratch or damage the plastic light lenses.
- ▶ Clean the plastic lenses of the exterior lighting using a wet sponge and a mild cleaning agent, e.g. Mercedes-Benz car shampoo. Or clean the exterior lighting with cleaning cloths.

### Cleaning the mirror turn signals

- ❗ Only use cleaning agents or cleaning cloths that are suitable for plastic lenses. Unsuitable cleaning agents or cleaning cloths could scratch or damage the plastic lenses of the mirror turn signals.
- ▶ Clean the plastic lenses of the mirror turn signals using a wet sponge and a mild cleaning agent, e.g. Mercedes-Benz car shampoo. Cleaning cloths may be used as well.

### Cleaning the sensors

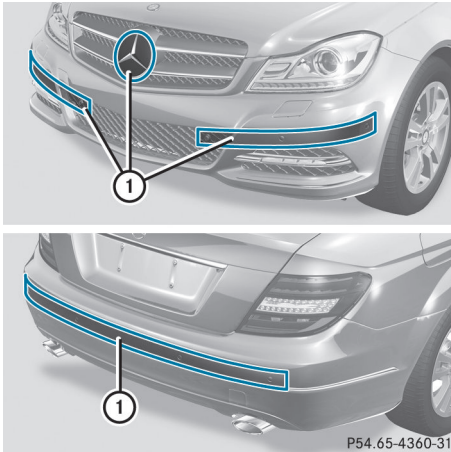

P54.65-4360-31

- ▶ Clean sensors ① of the driving systems with water, car shampoo and a soft cloth.

**!** If you clean the sensors with a power washer, make sure that you keep a distance of at least 11.8 in (30 cm) between the vehicle and the power washer nozzle. Information about the correct distance is available from the equipment manufacturer.

### Cleaning the rear view camera

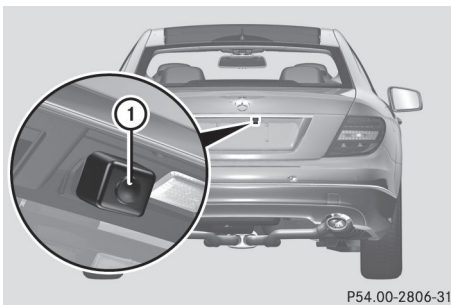

P54.00-2806-31

- ▶ Use clear water and a soft cloth to clean camera lens ①.
- !** Do not clean the camera lens and the area around the rear view camera with a power washer.

### Cleaning the exhaust pipes

Impurities combined with the effects of road grit and corrosive environmental factors may cause flash rust to form on the surface. You can restore the original shine of the exhaust tail pipe by cleaning it regularly, especially in winter and after washing.

- !** Do not clean the exhaust tail pipes with alkaline-based cleaning agents, such as wheel cleaner.
- ▶ Clean the exhaust tail pipes with a chrome care product tested and approved by Mercedes-Benz.

### Interior care

#### Cleaning the display

- ▶ Before cleaning the display, make sure that it is switched off and has cooled down.
- ▶ Clean the display surface using a commercially-available microfiber cloth and TFT/LCD display cleaner.
- ▶ Dry the display surface using a dry microfiber cloth.

**!** For cleaning, do not use any of the following:

- alcohol-based thinner or gasoline
- abrasive cleaning agents
- commercially-available household cleaning agents

These may damage the display surface. Do not put pressure on the display surface when cleaning. This could lead to irreparable damage to the display.

#### Cleaning the plastic trim

##### **!** WARNING

When cleaning the steering wheel boss and dashboard, do not use cockpit sprays or cleaning agents containing solvents. Cleaning agents containing solvents cause the surface to become porous, and as a result, plastic

parts may break away and be thrown around the interior when an air bag is deployed, which may result in severe injuries.

❗ Do not affix the following to plastic surfaces:

- stickers
- films
- scented oil bottles or similar items

You can otherwise damage the plastic.

❗ Do not allow cosmetics, insect repellent or sunscreen to come into contact with the plastic trim. This maintains the high-quality look of the surfaces.

- ▶ Wipe the plastic trim with a damp, lint-free cloth, e.g. a microfiber cloth.
- ▶ **Heavy soiling:** use car care and cleaning products recommended and approved by Mercedes-Benz. The surface may change color temporarily. Wait until the surface is dry again.

### Cleaning the steering wheel and gear or selector lever

- ▶ Thoroughly wipe with a damp cloth or use leather care agents that have been recommended and approved by Mercedes-Benz.

### Cleaning genuine wood and trim elements

- ▶ Wipe the wooden trim and trim pieces with a damp, lint-free cloth, e.g. a microfiber cloth.
- ▶ **Heavy soiling:** use car care and cleaning products recommended and approved by Mercedes-Benz.

❗ Do not use solvent-based cleaning agents such as tar remover, wheel cleaners, polishes or waxes. There is otherwise a risk of damaging the surface.

❗ Do not use chrome polish on trim pieces. The trim pieces have a chrome look but are

mostly made of anodized aluminum and can lose their shine if chrome polish is used. Use a damp, lint-free cloth instead when cleaning the trim pieces.

If the chrome-plated trim pieces are very dirty, you can use a chrome polish. If you are unsure as to whether the trim pieces are chrome-plated or not, consult an authorized Mercedes-Benz Center.

### Cleaning the seat covers

❗ Do not use microfiber cloths to clean genuine leather, artificial leather or Alcantara® covers. If used often, these can damage the cover.

❗ Observe the following when cleaning:

- clean genuine leather covers carefully with a damp cloth and then wipe the covers down with a dry cloth. Make sure that the leather does not become soaked. It may otherwise become rough and cracked. Only use leather care agents that have been tested and approved by Mercedes-Benz. You can obtain these from a qualified specialist workshop.
- clean artificial leather covers with a cloth moistened with a solution containing 1% detergent (e.g. dish washing liquid).
- clean cloth covers with a microfiber cloth moistened with a solution containing 1% detergent (e.g. dish washing liquid). Rub carefully and always wipe entire seat sections to avoid leaving visible lines. Leave the seat to dry afterwards. Cleaning results depend on the type of dirt and how long it has been there.
- clean Alcantara® covers with a damp cloth. Make sure that you wipe entire seat sections to avoid leaving visible lines.

i Note that regular care is essential to ensure that the appearance and comfort of the covers is retained over time.

### Cleaning the seat belts

---

- ▶ Use clean, lukewarm water and soap solution.

**!** Do not clean the seat belts using chemical cleaning agents. Do not dry the seat belts by heating at temperatures above 176 °F (80 °C) or in direct sunlight.

 **WARNING**

Do not bleach or dye seat belts as this may severely weaken them. In a crash, they may not be able to provide adequate protection.

### Cleaning the headliner and carpets

---

- ▶ **Headliner:** use a soft brush or a cleaning agent recommended and approved by Mercedes-Benz to remove heavy soiling.
- ▶ **Carpets:** use the carpet and textile cleaning agents recommended and approved by Mercedes-Benz.





Useful information .....	260
Where will I find...? .....	260
Flat tire .....	261
Battery .....	266
Jump-starting .....	269
Towing and tow-starting .....	270
Fuses .....	273

### Useful information

- i** This Operator's Manual describes all models and all standard and optional equipment of your vehicle available at the time of publication of the Operator's Manual. Country-specific differences are possible. Please note that your vehicle may not be equipped with all features described. This also applies to safety-related systems and functions.
- i** Please read the information on qualified specialist workshops (▷ page 23).

### Where will I find...?

#### First-aid kit

Depending on the vehicle's equipment, the first-aid kit is located either in an open stowage space or behind the cover on the left side.

- ▶ Open the trunk lid.

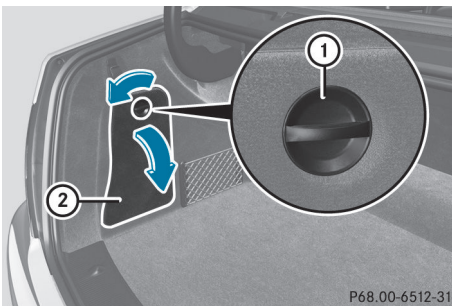

Example: first-aid kit behind the side trim panel

- ▶ **To open the cover:** turn rotary knob ① in the direction of the arrow and fold down cover ②.
- ▶ Remove the first-aid kit.

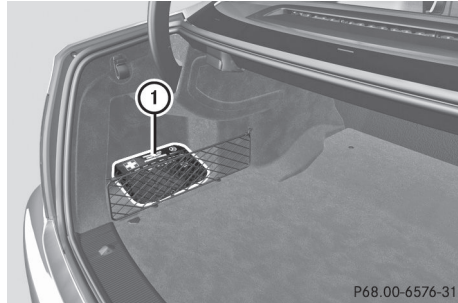

Example: first-aid kit in an open stowage space

- ▶ Remove first-aid kit ①.
- i** Check the expiration date on the first-aid kit at least once a year. Replace the contents if necessary, and replace missing items.

#### Vehicle tool kit

The vehicle tool kit can be found in the stowage well under the trunk floor.

- ▶ Lift the trunk floor upwards (▷ page 227).

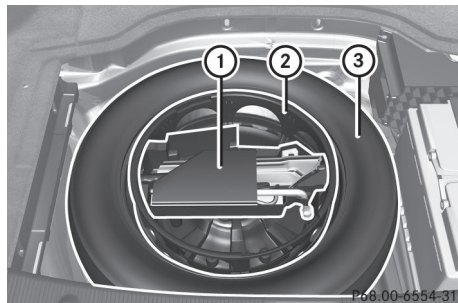

- ① Vehicle tool kit tray
- ② Stowage well
- ③ Spare wheel/"Minispare" emergency spare wheel

The vehicle tool kit contains:

- Folding wheel chock
- Fuse allocation chart
- Jack
- One pair of gloves

- Lug wrench
- Towing eye

### "Minispare" emergency spare wheel

The "Minispare" emergency spare wheel can be found in the stowage well under the trunk floor.

- ▶ Lift the trunk floor up (▷ page 227).

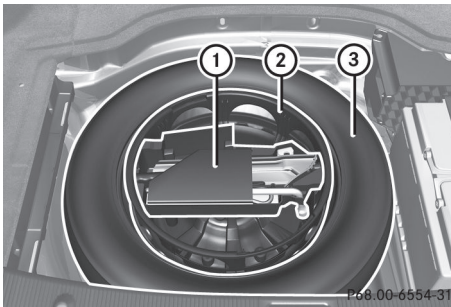

- ▶ Remove tool kit tray ①.
- ▶ Turn stowage tray ② counterclockwise and remove it.
- ▶ Remove "Minispare" emergency spare wheel ③.

For further information on changing a wheel and installing the spare wheel, see (▷ page 261).

## Flat tire

### Preparing the vehicle

- ▶ Stop the vehicle on solid, non-slippery and level ground, as far away as possible from traffic.
- ▶ Switch on the hazard warning lamps.
- ▶ Apply the parking brake firmly.
- ▶ Bring the front wheels into the straight-ahead position.
- ▶ Move the selector lever to position **P**.
- ▶ Switch off the engine.

- ▶ **Vehicles without KEYLESS-GO:** remove the SmartKey from the ignition lock.
- ▶ **Vehicles with KEYLESS-GO:** open the driver's door.  
The on-board electronics have status **0**, which is the same as the SmartKey having been removed.
- ▶ **Vehicles with KEYLESS-GO:** remove the Start/Stop button from the ignition lock (▷ page 125).
- ▶ All occupants must get out of the vehicle. Make sure that they are not endangered as they do so.
- ▶ Make sure that no one is near the danger area while a wheel is being changed. Anyone who is not directly assisting in the wheel change should, for example, stand behind the barrier.
- ▶ Get out of the vehicle. Pay attention to traffic conditions when doing so.
- ▶ Close the driver's door.

### Changing a wheel and mounting the spare wheel

#### Preparing the vehicle

When using a different size spare wheel or emergency spare wheel, do not exceed the maximum road speed of 50 mph (80 km/h)

#### **WARNING**

The wheel or tire size as well as the tire type of the spare wheel or emergency spare wheel and the wheel to be replaced may differ. Mounting an emergency spare wheel may severely impair the driving characteristics. There is a risk of an accident.

To avoid hazardous situations:

- adapt your driving style accordingly and drive carefully.
- never install more than one spare wheel or emergency spare wheel that differs in size.
- only use a spare wheel or emergency spare wheel of a different size briefly.

- do not switch ESP® off.
- have a spare wheel or emergency spare wheel of a different size replaced at the nearest qualified specialist workshop. Observe that the wheel and tire dimensions as well as the tire type must be correct.

**i** Vehicles without a spare wheel or emergency spare wheel are not equipped with a tire-change tool kit at the factory. For more information on which tools are required to perform a wheel change on your vehicle, e.g. wheel chock, lug wrench or alignment bolt, consult an authorized Mercedes-Benz Center.

- ▶ Prepare the vehicle as described (▷ page 261).
- ▶ Remove the following items (depending on the vehicle's equipment) from the stowage well under the trunk floor:
  - emergency spare wheel
  - folding wheel chock
  - lug wrench
  - jack
- ▶ Secure the vehicle to prevent it from rolling away.

### Securing the vehicle to prevent it from rolling away

If your vehicle is equipped with a wheel chock, it can be found in the vehicle tool kit (▷ page 260).

The folding wheel chock is an additional securing measure to prevent the vehicle from rolling away, for example when changing a wheel.

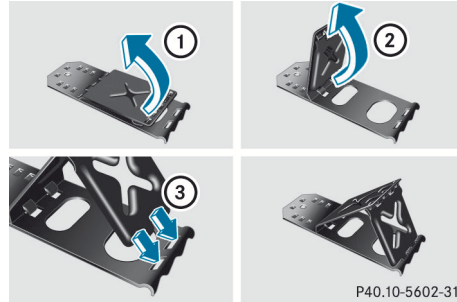

P40.10-5602-31

- ▶ Fold both plates upwards ①.
- ▶ Fold out lower plate ②.
- ▶ Guide the lugs on the lower plate fully into the openings in base plate ③.

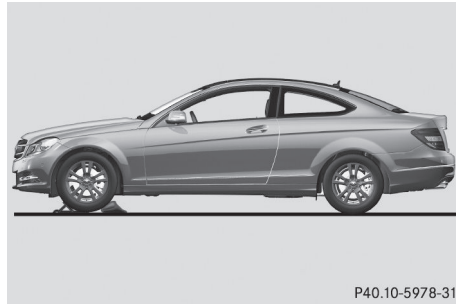

P40.10-5978-31

Securing the vehicle on level ground

- ▶ **On level ground:** place chocks or other suitable items under the front and rear of the wheel that is diagonally opposite the wheel you wish to change.

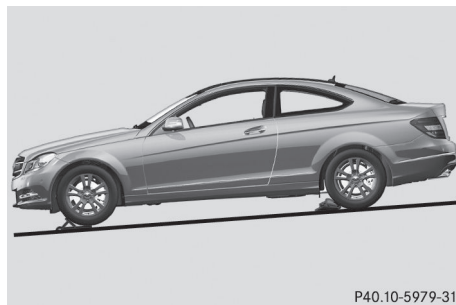

P40.10-5979-31

Securing the vehicle on slight downhill gradients

- ▶ **On downhill gradients:** place chocks or other suitable items in front of the wheels of the front and rear axle.

## Raising the vehicle

### WARNING

If you do not position the jack correctly at the appropriate jacking point of the vehicle, the jack could tip over with the vehicle raised. There is a risk of injury.

Only position the jack at the appropriate jacking point of the vehicle. The base of the jack must be positioned vertically, directly under the jacking point of the vehicle.

The following must be observed when raising the vehicle:

- to raise the vehicle, only use the vehicle-specific jack that has been tested and approved by Mercedes-Benz. If used incorrectly, the jack could tip over with the vehicle raised.
- the jack is designed only to raise and hold the vehicle for a short time while a wheel is being changed. It is not suited for performing maintenance work under the vehicle.
- avoid changing the wheel on uphill and downhill slopes.
- before raising the vehicle, secure it from rolling away by applying the parking brake and inserting wheel chocks. Never disengage the parking brake while the vehicle is raised.
- the jack must be placed on a firm, flat and non-slip surface. On a loose surface, a large, load-bearing underlay must be used. On a slippery surface, a non-slip underlay must be used, e.g. rubber mats.
- do not use wooden blocks or similar objects as a jack underlay. Otherwise, the jack will not be able to achieve its load-bearing capacity due to the restricted height.
- The maximum clearance between the underside of the tire and the ground must be 1.2 in (3 cm).
- never place your hands and feet under the raised vehicle.
- never lie under the raised vehicle.
- never start the engine when the vehicle is raised.
- never open or close a door or the trunk lid when the vehicle is raised.
- make sure that no persons are present in the vehicle when the vehicle is raised.

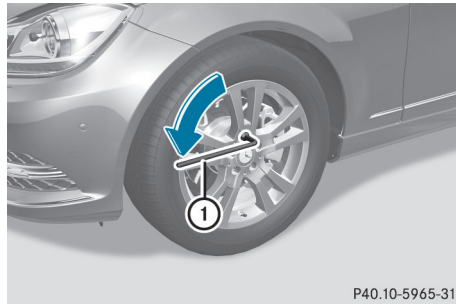

- ▶ Using lug wrench (1), loosen the bolts on the wheel you wish to change by about one full turn. Do not unscrew the bolts completely.

The jacking points are located just behind the wheel housings of the front wheels and just in front of the wheel housings of the rear wheels (arrows).

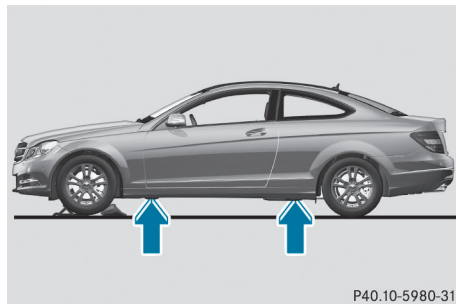

- ❗ The jack is designed exclusively for jacking up the vehicle at the jacking points. Otherwise, your vehicle could be damaged.

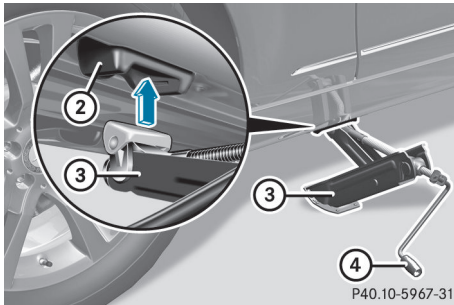

- ▶ Position jack (3) at jacking point (2).

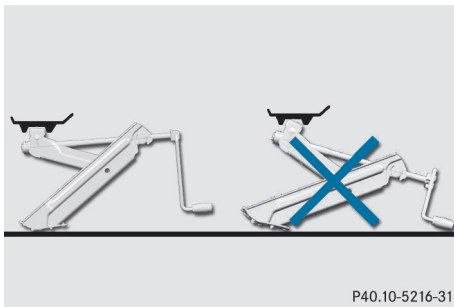

- ▶ Make sure that the base of the jack is positioned directly under the jacking point.
- ▶ Turn crank (4) clockwise until jack (3) sits completely on jacking point (2) and the base of the jack lies evenly on the ground.
- ▶ Turn handle (4) until the tire is 1.2 in (3 cm) from the ground at most.

### Removing a wheel

- ▶ Unscrew the wheel bolts.
- ❗ Do not place wheel bolts in sand or on a dirty surface. The bolt and wheel hub threads could otherwise be damaged when you screw them in.
- ▶ Remove the wheel.

### Mounting a new wheel

#### ⚠ WARNING

Oiled or greased wheel bolts or damaged wheel bolts/hub threads can cause the wheel

bolts to come loose. As a result, you could lose a wheel while driving. There is a risk of accident.

Never oil or grease wheel bolts. In the event of damage to the threads, contact a qualified specialist workshop immediately. Have the damaged wheel bolts or hub threads replaced/renewed. Do not continue driving.

#### ⚠ WARNING

If you tighten the wheel bolts or wheel nuts when the vehicle is raised, the jack could tip over. There is a risk of injury.

Only tighten the wheel bolts or wheel nuts when the vehicle is on the ground.

Always pay attention to the instructions and safety notices in "Changing a wheel" (▶ page 300).

(▶ page 300).

Only use wheel bolts that have been designed for the wheel and the vehicle. For safety reasons, Mercedes-Benz recommends that you only use wheel bolts which have been approved for Mercedes-Benz vehicles and the respective wheel.

Be sure to use the original-length wheel bolts when refitting the original wheel after it has been repaired.

- ▶ Clean the wheel and wheel hub contact surfaces.

- ❗ To prevent damage to the paintwork, hold the wheel securely against the wheel hub while screwing in the first wheel bolt.

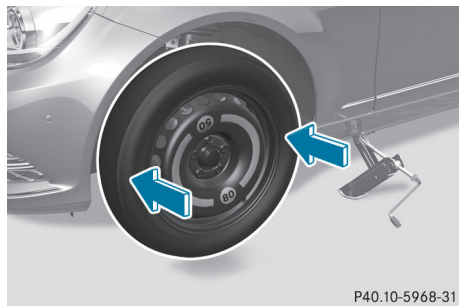



- ▶ Place the emergency spare wheel on the wheel hub and push it on.
- ▶ Tighten the wheel bolts until they are finger-tight.

### Lowering the vehicle

#### WARNING

Tire pressure that is too high or too low can lead to a blowout of the mounted emergency spare wheel/spare wheel, particularly when driving with a heavy load and increasing speed. There is a risk of accident.

Check the tire pressure of the emergency spare wheel or spare wheel and adjust it. When doing so, observe the specified tire pressure.

- ▶ Turn the crank of the jack counter-clockwise until the vehicle is once again standing firmly on the ground.
- ▶ Place the jack to one side.

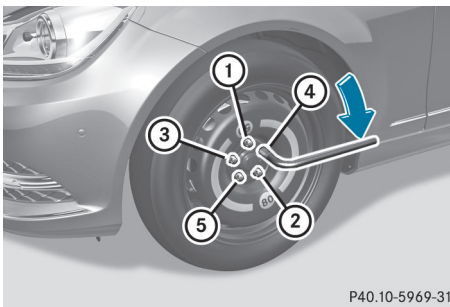

#### WARNING

The wheels could work loose if the wheel nuts and bolts are not tightened to the specified tightening torque. There is a risk of accident. Have the tightening torque immediately checked at a qualified specialist workshop after a wheel is changed.

- ▶ Tighten the wheel bolts evenly in a crosswise pattern in the sequence indicated (① to ⑤). The tightening torque must be **96 lb-ft (130 Nm)**.

- ▶ Turn the jack back to its initial position and store it together with the rest of the tire-change tool kit in the stowage well under the trunk floor.

- ▶ Transport the defective wheel in the trunk. or

- ▶ Depending on the size of the wheel, you may also be able to secure the defective wheel in the spare wheel well. In this case, you will have to remove the stowage tray from the spare wheel well and stow it securely in the trunk.

- i** USA only: when you are driving with the emergency spare wheel mounted, the tire pressure monitoring system cannot function reliably. Only restart the tire pressure monitoring system when the defective wheel has been replaced with a new wheel.

All wheels mounted must be equipped with functioning sensors. The defective wheel should no longer be in the vehicle.

### MOExtended tires (tires with run-flat properties)

With MOExtended tires (tires with run flat characteristics), you can continue to drive your vehicle even if there is a total loss of pressure in one or more tires.

MOExtended tires may only be used in conjunction with the activated tire pressure loss warning system or with the activated tire pressure monitoring system.

The driving distance in partially laden condition is approximately 50 miles (80 km), and approximately 18 miles (30 km) when fully loaded.

In addition to the vehicle load, the driving distance possible depends upon:

- speed
- road condition
- outside temperature

The driving distance possible in run-flat mode may be reduced by extreme driving conditions/maneuvers, or it can be increased through a moderate style of driving.

The maximum permissible distance which can be driven in run-flat mode is counted from the moment the tire pressure loss warning appears in the multifunction display.

Do not exceed a vehicle speed of 50 mph (80 km/h).

#### WARNING

When driving in emergency mode, the driving characteristics deteriorate, e.g. when cornering, accelerating quickly and when braking. There is a risk of an accident.

Do not exceed the stated maximum speed. Avoid abrupt steering and driving maneuvers, and driving over obstacles (curbs, potholes, off-road). This applies in particular to a laden vehicle.

Stop driving in emergency mode if:

- you hear banging noises.
- the vehicle starts to shake.
- you see smoke and smell rubber.
- ESP® is intervening constantly.
- there are tears in the sidewalls of the tire.

After driving in emergency mode, have the wheel rims checked at a qualified specialist workshop with regard to their further use. The defective tire must be replaced in every case.

-  When replacing one or all tires, make sure that you only use tires marked MOExtended. Also ensure that they are of the specified size for the vehicle.

## Battery

### Important safety notes

In order for the battery to achieve the maximum possible service life, it must always be sufficiently charged.

-  Have the battery checked regularly at a qualified specialist workshop.

Observe the service intervals in the Maintenance Booklet or contact a qualified specialist workshop for more information.

Have the battery charge level checked more frequently if you use the vehicle mainly for short trips or if you leave it standing idle for a lengthy period.

Only replace a battery with a battery that has been recommended by Mercedes-Benz.

Consult a qualified specialist workshop if you wish to leave your vehicle parked for a long period of time.

#### WARNING

Comply with safety precautions and take protective measures when handling batteries.

Risk of explosion



Fire, naked flames and smoking are prohibited when handling the battery. Avoid creating sparks.



Battery acid is caustic. Avoid contact with the skin, eyes or clothing.



Wear suitable protective clothing, in particular gloves, an apron and a face mask.

Immediately rinse acid splashes off with clean water. Consult a doctor if necessary.

Wear eye protection.







Keep children away.



Observe this Operator's Manual.



#### Environmental note



Batteries contain dangerous substances. It is against the law to dispose of them with the household rubbish. They must be collected separately and recycled to protect the environment.



Dispose of batteries in an environmentally friendly manner. Take discharged batteries to a qualified specialist workshop or a special collection point for used batteries.



#### WARNING

Failure to follow these instructions can result in severe injury or death.

Never lean over batteries while connecting. You might get injured.

Battery fluid contains sulfuric acid. Do not allow this fluid to come in contact with eyes, skin or clothing. In case it does, immediately flush affected area with water and seek medical help if necessary.

A battery will also produce hydrogen gas, which is flammable and explosive. Keep flames or sparks away from battery, avoid improper connection of jumper cables, smoking etc.



#### WARNING

Do not place any metal objects on the battery as this could result in a short circuit.

Use leak-proof batteries only to avoid the risk of acid burns in the event of an accident.

Take care that you do not become statically charged, e.g. by wearing synthetic clothing or rubbing against textiles. For this reason, you also should not pull or push the battery over carpets or other synthetic materials.

Never touch the battery first. First, touch the outside body of the vehicle in order to release any possible electrostatic charges.

Do not rub the battery with rags or cloths. The battery could explode if touched due to electrostatic charge or due to spark formation.

**!** Before working on the battery, e.g. loosening the battery terminals, switch off the engine and remove the SmartKey from the ignition. On vehicles with KEYLESS-GO, make sure that the ignition is switched off. Check that all the indicator lamps in the instrument cluster are off. You may otherwise destroy electronic components, such as the alternator.

**!** Like other batteries, the vehicle battery may discharge over time if you do not use the vehicle. In this case, have the battery disconnected at a qualified specialist workshop. You can also charge the battery with a charger recommended by Mercedes-Benz. Contact a qualified specialist workshop for further information.

The battery and the cover of the positive terminal clamp must be installed securely during operation.

**i** Remove the SmartKey if you park the vehicle and do not require any electrical consumers. The vehicle will then use very little energy, thus conserving battery power.

Mercedes-Benz recommends that you do not carry out work on batteries yourself, e.g. removing or charging. Have this work performed at a qualified specialist workshop.

**i** If the power supply has been interrupted, e.g. if you reconnect the battery, you will have to:

- set the clock; see the separate operating instructions.

On vehicles with COMAND and a navigation system, the clock is set automatically.

- reset the function for automatically folding the exterior mirrors in/out by folding the mirrors out once (▷ page 94)<sup>16</sup>

### Charging the battery

#### WARNING

Never charge a battery still installed in the vehicle unless a battery charger unit approved by Mercedes-Benz is being used. Gases may escape during charging and cause explosions that may result in paint damage, corrosion or personal injury.

A battery charger unit specially adapted for Mercedes-Benz vehicles and tested and approved by Mercedes-Benz is available as an accessory. It permits the charging of the battery in its installed position. Contact an authorized Mercedes-Benz Center for further information and availability.

Charge the battery in accordance with the separate instructions for the battery charger.

#### WARNING

There is a risk of acid burns during the charging process due to the gases which escape from the battery. Do not lean over the battery during the charging process.

#### WARNING

Battery acid is caustic. Avoid contact with the skin, eyes or clothing.

- !** Only charge the installed battery with a battery charger which has been tested and

approved by Mercedes-Benz. These battery chargers allow the battery to be charged while still installed in the vehicle.

- !** Only use battery chargers with a maximum charging voltage of 14.8 V.

- !** Only charge the battery using the jump-starting connection point.

The jump-starting connection point is in the engine compartment (▷ page 269).

- ▶ Open the hood (▷ page 246).
- ▶ Connect the battery charger to the positive terminal and ground point in the same order as when connecting the donor battery in the jump-starting procedure (▷ page 269).
- ▶ Read the battery charger's operating instructions before charging the battery.

<sup>16</sup> This function is only available in vehicles for Canada.

## Jump-starting

### WARNING

Failure to follow these directions will cause damage to the electronic components, and can lead to a battery explosion and severe injury or death.

Never lean over batteries while connecting or jump starting. You might get injured.

Battery fluid contains sulfuric acid. Do not allow this fluid to come in contact with eyes, skin or clothing. In case it does, immediately flush affected area with water, and seek medical help if necessary.

A battery will also produce hydrogen gas, which is flammable and explosive. Keep flames or sparks away from battery, avoid improper connection of jumper cables, smoking, etc.

Attempting to jump start a frozen battery can result in it exploding, causing personal injury.

Read all instructions before proceeding.

### WARNING

Non-combusted fuel can collect in the exhaust system and ignite. There is a risk of fire. Avoid repeated and lengthy starting attempts.

**!** Avoid repeated and lengthy starting attempts. Otherwise, the catalytic converter could be damaged by the non-combusted fuel.

Do not use a rapid charging device to start the vehicle. If your vehicle's battery is discharged, the engine can be jump-started from another vehicle or from a second battery using jumper cables. Observe the following points:

- The battery is not accessible in all vehicles. If the other vehicle's battery is not accessible, jump-start the vehicle using a second battery or a jump-starting device.
- You may only jump-start the vehicle when the engine and catalytic converter are cold.
- Do not start the engine if the battery is frozen. Let the battery thaw first.
- jump-starting may only be performed from batteries with a nominal voltage of 12 V.
- Only use jumper cables which have a sufficient cross-section and insulated terminal clamps.
- If the battery is fully discharged, leave the battery that is being used to jump-start connected for a few minutes before attempting to start. This charges the empty battery a little.
- Make sure that the two vehicles do not touch.

Make sure that:

- the jumper cables are not damaged.
  - bare parts of the terminal clamp do not come into contact with other metal parts while the jumper cables are connected to the battery.
  - the jumper cables cannot come into contact with parts such as the V-belt pulley or the fan. These parts move when the engine is started and while it is running.
- ▶ Apply the parking brake firmly.
  - ▶ Move the selector lever to position **P**.
  - ▶ Switch off all electrical consumers (e.g. radio, blower, etc.).
  - ▶ Open the hood (▶ page 246).

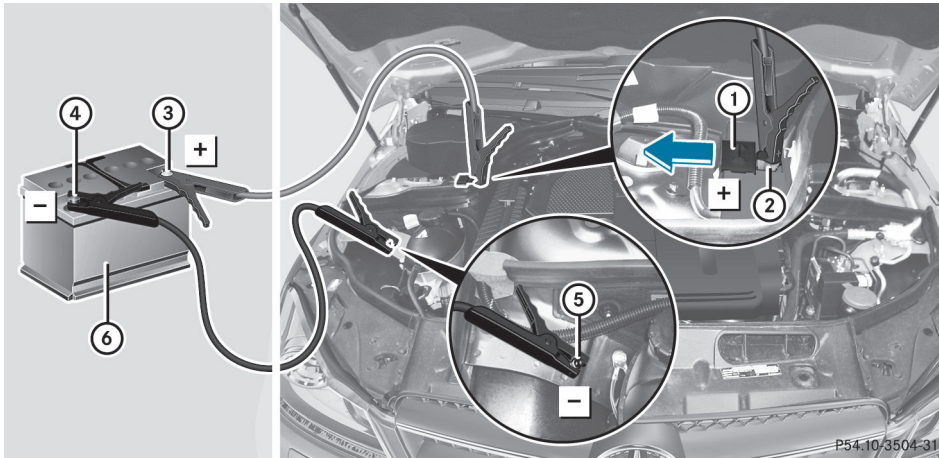

Position number ⑥ identifies the charged battery of the other vehicle or an equivalent jump-starting device.

- ▶ Slide cover ① of positive terminal ② in the direction of the arrow.
- ▶ Connect positive terminal ② on your vehicle to positive terminal ③ of donor battery ⑥ using the jumper cable, beginning with your own battery.
- ▶ Start the engine of the donor vehicle and run it at idling speed.
- ▶ Connect negative terminal ④ of donor battery ⑥ to ground point ⑤ of your vehicle using the jumper cable, connecting the jumper cable to donor battery ⑥ first.
- ▶ Start the engine.
- ▶ Before disconnecting the jumper cables, let the engine run for several minutes.
- ▶ First remove the jumper cables from ground point ⑤ and negative terminal ④, then from positive terminal ② and positive terminal ③, each time beginning at the contacts on your own vehicle first.
- ▶ Close cover ① of positive terminal ② after removing the jumper cables.
- ▶ Have the battery checked at a qualified specialist workshop.

**i** Jump-starting is not considered to be a normal operating condition.

**i** Jumper cables and further information regarding jump starting can be obtained at any qualified specialist workshop.

## Towing and tow-starting

### Important safety notes

#### **⚠ WARNING**

If you tow the vehicle, you must use a rigid towing bar if:

- the engine is not running.
- there is a brake system malfunction.
- there is a malfunction in the power supply or the vehicle's electrical system.

The power assistance for the steering and the brake force booster do not work when the engine is not running. You will need more

force to steer and brake, you may have to depress the brake pedal with maximum force.

Before towing away, make sure that the steering can be moved and is not locked.

If you tow or tow-start another vehicle, its weight must not exceed the maximum permissible gross vehicle weight of your vehicle.

### **WARNING**

The vehicle is braked if the HOLD function is activated. Therefore, deactivate HOLD if the vehicle is to be towed.

It is better to have the vehicle transported than to have it towed.

**!** The vehicle can be towed a maximum of 30 miles (50km). The towing speed of 30 mph (50 km/h) must not be exceeded.

If the vehicle has to be towed more than 30 miles (50km), the entire vehicle must be raised and transported.

**!** Only secure the tow rope or tow bar at the towing eyes. Otherwise, the vehicle could be damaged.

**!** Do not use the towing eye for recovery, as this could damage the vehicle. If in doubt, recover the vehicle with a crane.

**!** When towing, pull away slowly and smoothly. If the tractive power is too high, the vehicles could be damaged.

**!** Do not tow with sling-type equipment. This could damage the vehicle.

**!** On vehicles with KEYLESS-GO, use the SmartKey instead of the Start/Stop button. Turn the SmartKey to position **2** in the ignition lock and shift the automatic transmission to **N**. Then, turn the SmartKey back to **0** and leave it in the ignition lock.

The automatic transmission must be in position **N** when the vehicle is being towed.

The battery must be connected and charged. Otherwise, you:

- cannot turn the SmartKey to position **2** in the ignition lock
- cannot shift the automatic transmission to position **N**

Release the selector lever lock manually to move it out of position **P** (▷ page 137).

- i** Switch off the automatic locking feature (▷ page 73) You could otherwise be locked out when pushing or towing the vehicle.

### Installing/removing the towing eye

#### Installing the towing eye

- Remove the towing eye from the vehicle tool kit (▷ page 260).

### **WARNING**

The exhaust tail pipe may be hot. You could burn yourself if you touch the tail pipe. Be particularly careful when removing the rear cover.

The mountings for the removable towing eyes are located in the bumpers. They are at the front and at the rear, under the covers.



R54.10-3488-31

- ▶ Take cover ① off the opening.
- ▶ Screw the towing eye in clockwise to the stop and tighten it.

### Removing the towing eye

- ▶ Loosen the towing eye and unscrew it.
- ▶ Attach cover ① to the bumper and press until it engages.
- ▶ Place the towing eye in the vehicle tool kit.

### Towing the vehicle with the rear axle raised

#### Only possible on vehicles without 4MATIC.

When towing your vehicle with the rear axle raised, it is important that you observe the safety instructions (▷ page 270).

**!** The ignition must be switched off if you are towing the vehicle with the rear axle raised. Intervention by ESP® could otherwise damage the brake system.

- ▶ Switch on the hazard warning lamps (▷ page 101).
- ▶ Turn the SmartKey to position **0** in the ignition lock and remove the SmartKey from the ignition lock.
- ▶ When leaving the vehicle, take the SmartKey or the KEYLESS-GO key with you.

### Towing a vehicle with both axles on the ground

When having your vehicle towed, observe the important safety notes (▷ page 270).

#### WARNING

The power assistance for the steering and the brake force booster do not work when the engine is not running. You will then need much more effort to brake and steer the vehicle. Adapt your style of driving accordingly.

- ▶ Switch on the hazard warning lamps (▷ page 101).
- i** When towing with the hazard warning lamps switched on, use the combination switch as usual to signal a change of direction. In this case, only the turn signals for the desired direction flash. When the combination switch is reset, the hazard warning lamps start flashing again.
- ▶ Turn the SmartKey to position **2** in the ignition lock.
- ▶ When the vehicle is stationary, depress the brake pedal and keep it depressed.
- ▶ Shift the automatic transmission to position **N**.
- ▶ Release the brake pedal.
- ▶ Release the parking brake.

### Transporting the vehicle

The towing eye can be used to pull the vehicle onto a trailer or transporter for transporting purposes.

- ▶ Turn the SmartKey to position **2** in the ignition lock.
- ▶ Shift the automatic transmission to position **N**.

#### As soon as the vehicle is loaded:

- ▶ Prevent the vehicle from rolling away by applying the parking brake.
- ▶ Move the selector lever to **P**.
- ▶ Turn the SmartKey to position **0** in the ignition lock and remove the SmartKey from the ignition lock.
- ▶ Secure the vehicle.
- !** Only lash the vehicle down by the wheels or wheel rims, not by parts of the vehicle such as axle or steering components. Otherwise, the vehicle could be damaged.

### Notes for 4MATIC vehicles

**!** Vehicles with 4MATIC must not be towed with either the front or the rear axle raised, as doing so will damage the transmission.

If the vehicle has transmission damage or damage to the front or rear axle, have it transported on a transporter or trailer.

### In the event of damage to the electrical system

If the battery is defective, the automatic transmission will be locked in position **P**. To shift the automatic transmission to position **N**, you must provide power to the vehicle's electrical system in the same way as when jump-starting (▷ page 269).

Have the vehicle transported on a transporter or trailer.

### Tow-starting (emergency starting)

**!** Vehicles with automatic transmission must not be started by tow-starting. This could otherwise damage the transmission.

For further information on "Jump-starting" see (▷ page 269).

## Fuses

### Important safety notes

#### WARNING

Only use fuses that have been approved for Mercedes-Benz vehicles and that have the correct fuse rating for the systems concerned. Do not attempt to repair or bridge faulty fuses. Using fuses that have not been approved or attempting to repair or bridge faulty fuses could cause the fuse to be overloaded and result in a fire. Have the cause traced and rectified at a qualified specialist workshop.

The fuses in your vehicle serve to close down faulty circuits. If a fuse blows, all the

components on the circuit and their functions stop operating.

Blown fuses must be replaced with fuses of the same rating, which you can recognize by the color and value. The fuse ratings are listed in the fuse allocation chart.

If a newly inserted fuse also blows, have the cause traced and rectified at a qualified specialist workshop, e.g. an authorized Mercedes-Benz Center.

**!** Only use fuses that have been approved for Mercedes-Benz vehicles and which have the correct fuse rating for the system concerned. Otherwise, components or systems could be damaged.

### Before changing a fuse

- ▶ Park the vehicle and apply the parking brake.
- ▶ Switch off all electrical consumers.
- ▶ Remove the SmartKey from the ignition lock.

The fuses are located in various fuse boxes:

- fuse box in the engine compartment on the left-hand side of the vehicle, when viewed in the direction of travel
- fuse box in the trunk on the right-hand side of the vehicle, when viewed in the direction of travel

The fuse allocation chart is located in the vehicle tool kit (▷ page 260) in the stowage compartment under the trunk floor.

### Fuse box in the engine compartment

- ▶ Make sure that the windshield wipers are turned off.

#### WARNING

Make sure that the windshield wipers are switched off and that the SmartKey is removed from the ignition lock before you open the cover of the fuse box. Otherwise, the



windshield wipers and the wiper rods above the cover could be set in motion. This could lead to you or others being injured by the wiper rods.

- ▶ Open the hood (▷ page 246).

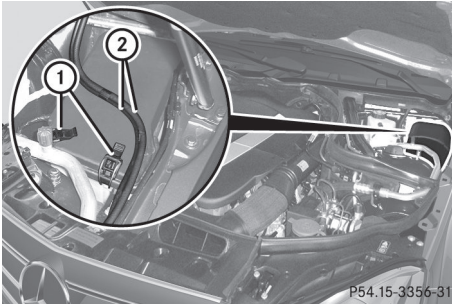

P54.15-3856-31

- ▶ Remove any existing moisture from the fuse box using a dry cloth.
- ▶ Take lines ② from the guides.
- ▶ **To open:** open clamps ①.
- ▶ Remove the fuse box cover forwards.
- ❗ Make sure that no moisture can enter the fuse box when the cover is open.
- ▶ **To close:** check whether the rubber seal is lying correctly in the cover.
- ▶ Insert the cover at the rear of the fuse box into the retainer.
- ▶ Fold down the cover and close clamps ①.
- ▶ Secure lines ② in the guides.
- ❗ The cover must be seated properly, otherwise moisture or dirt could impair the function of the fuses.
- ▶ Close the hood (▷ page 247).

### Fuse box in the trunk

- ▶ Open the trunk (▷ page 75).

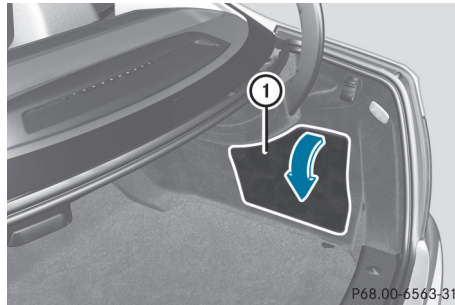

P68.00-6563-31

- ▶ **To open:** release cover ① at the top and open it downwards in the direction of the arrow.



Useful information .....	276
Important safety notes .....	276
Operation .....	276
Winter operation .....	278
Tire pressure .....	280
Loading the vehicle .....	287
Maximum load rating .....	291
Uniform Tire Quality Grading Standards .....	292
Tire labeling .....	293
Definition of terms for tires and loading .....	297
Changing a wheel .....	300
Wheel and tire combinations .....	300

### Useful information

- i** This Operator's Manual describes all models and all standard and optional equipment of your vehicle available at the time of publication of the Operator's Manual. Country-specific differences are possible. Please note that your vehicle may not be equipped with all features described. This also applies to safety-related systems and functions.
- i** Please read the information on qualified specialist workshops (▷ page 23).

### Important safety notes

#### WARNING

If wheels and tires of the wrong size are used, the wheel brakes or suspension components may be damaged. There is a risk of accident. Always replace wheels and tires with those that fulfill the specifications of the original part (designation, manufacturer, model).

#### WARNING

A flat tire severely impairs the driving, steering and braking characteristics of the vehicle. There is a risk of accident.

Tires without run-flat characteristics:

- do not drive with a flat tire.
- immediately replace the flat tire with your emergency spare wheel or spare wheel, or consult a qualified specialist workshop.

Tires with run-flat characteristics:

- pay attention to the information and warning notices on MOExtended tires (tires with run-flat characteristics).

Accessories that are not approved for your vehicle by Mercedes-Benz or are not being used correctly can impair the operating safety.

Before purchasing and using non-approved accessories, visit a qualified specialist workshop and inquire about:

- suitability
- legal stipulations
- factory recommendations

Information on the dimensions and types of wheels and tires for your vehicle can be found in the "Wheel/tire combinations" section (▷ page 300).

Information on air pressure for the tires on your vehicle can be found:

- on the vehicle's Tire and Loading Information placard on the B-pillar
- on the tire pressure label on the fuel filler flap
- in the "Tire pressure" section

Pay special attention to the country-specific requirements for tire approval. These requirements can stipulate a specific tire type for your vehicle. Furthermore, the use of certain tire types in certain regions and areas of operation can be highly beneficial. You can find further information regarding tires at specialist tire retailers, at qualified specialist workshops or at any authorized Mercedes-Benz Center.

- i** Further information on wheels and tires can be obtained at any qualified specialist workshop.

### Operation

#### Notes on driving

- If the vehicle is heavily laden, check the tire pressures and correct them if necessary.
- When parking your vehicle, make sure that the tires do not get deformed by the curb or other obstacles. If it is necessary to drive over curbs, speed humps or similar elevations, try to do so slowly and at an obtuse angle. Otherwise, the tires, particularly the sidewalls, can get damaged.

### Notes on regularly inspecting wheels and tires

#### WARNING

Damaged tires can cause tire inflation pressure loss. As a result, you could lose control of your vehicle. There is a risk of accident.

Check the tires regularly for signs of damage and replace any damaged tires immediately.

- Regularly check the wheels and tires of your vehicle for damage (e.g. cuts, punctures, tears, bulges on tires and deformation or cracks or severe corrosion on wheels) at least once a month, as well as after driving off-road or on rough roads. Damaged wheels can cause a loss of tire pressure.
- Regularly check the tire tread depth and the condition of the tread across the whole width of the tire (> page 277). If necessary, turn the front wheels to full lock in order to inspect the inner side of the tire surface.
- All wheels must have a valve cap to protect the valve against dirt and moisture. Do not mount anything onto the valve (such as tire pressure monitoring systems) other than the standard valve cap or other valve caps approved by Mercedes-Benz for your vehicle.
- Regularly check the pressure of all the tires including the emergency spare wheel or the spare wheel, particularly prior to long trips, and correct the pressure as necessary (> page 280).

### Tire tread

#### WARNING

Insufficient tire tread will reduce tire traction. The tire is no longer able to dissipate water. This means that on wet road surfaces, the risk of hydroplaning increases, in particular where speed is not adapted to suit the driving conditions. There is a risk of accident.

If the tire pressure is too high or too low, tires may exhibit different levels of wear at different locations on the tire tread. Thus, you should regularly check the tread depth and the condition of the tread across the entire width of all tires.

Minimum tire tread depth for:

- Summer tires:  $\frac{1}{8}$  in (3 mm)
- M+S tires:  $\frac{1}{16}$  in (4 mm)

For safety reasons, replace the tires before the legally prescribed limit for the minimum tire tread depth is reached.

Tread wear indicators (TWI) are required by law. Six indicators are positioned on the tire tread. They are visible once the tread depth is approximately  $\frac{1}{16}$  in (1.6 mm). If this is the case, the tire is so worn that it must be replaced.

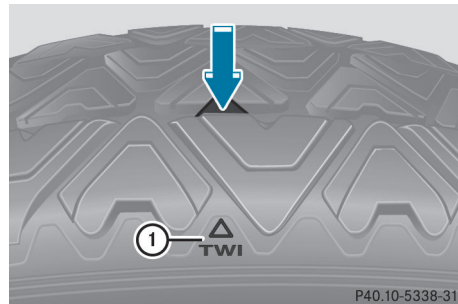

Bar marking ① for tread wear is integrated into the tire tread.

### Notes on selecting, mounting and replacing tires

- Only mount tires and wheels of the same type and make.
- Only mount tires of the correct size onto the wheels.
- After mounting new tires, run them in at moderate speeds for the first 60 miles (100 km) as they only reach their full performance after this distance.

- Do not drive with tires which have too little tread depth, as this significantly reduces the traction on wet roads (hydroplaning).
- Replace the tires after six years at the latest, regardless of wear. This also applies to the spare wheel/emergency spare wheel.

The service life of tires depends on the following factors amongst other things:

- driving style
- tire pressure
- distance covered

### MOExtended tires (tires with run-flat properties)

MOExtended tires (tires with run-flat properties) allow you to continue driving your vehicle even if one or more tires are entirely deflated.

MOExtended tires may be used only in conjunction with the activated tire pressure loss warning system or the activated tire pressure monitoring system and only on wheels specifically tested by Mercedes-Benz. Notes on driving with MOExtended tires in the event of a flat tire can be found in the "Breakdown assistance" section (> page 265).

### Winter operation

#### Please bear the following in mind

Have your vehicle winterproofed at a qualified specialist workshop at the onset of winter. Observe the notes in the "Changing a wheel" section (> page 300).

#### Driving with summer tires

At temperatures below 45 °F (+7 °C), the elasticity of summer tires and therefore also the traction and braking capability are reduced considerably. Mount M+S tires on

your vehicle. Using summer tires at very cold temperatures could cause cracks to form, thereby damaging the tires permanently. Mercedes-Benz cannot accept responsibility for this type of damage.

### M+S tires

At temperatures below 45 °F (+7 °C), use winter tires or all-season tires. Both types of tire are identified by the M+S marking.

Only winter tires bearing the  snowflake symbol in addition to the M+S marking provide the best possible grip in wintry road conditions. Only these tires will allow driving safety systems such as ABS and ESP® to function optimally in winter. These tires have been developed specifically for driving in snow.

Use M+S tires of the same make and tread on all wheels to maintain safe handling characteristics.

### WARNING

M+S tires with a tire tread depth of less than 1/8 in (4 mm) are not suitable for use in winter and do not provide sufficient traction. There is a risk of an accident.

M+S tires with a tread depth of less than 1/8 in (4 mm) must be replaced immediately.

Always observe the maximum permissible speed specified for the M+S tires you have mounted.

When you have mounted M+S tires:

- ▶ Check the tire pressures (> page 283).
- ▶ **Vehicles for Canada:** restart the tire pressure loss warning system (> page 283).
- ▶ Restart the tire pressure monitor (> page 284).

Drive no faster than 50 mph (80 km/h) with the spare wheel or emergency spare wheel mounted.

**⚠ WARNING**

The wheel or tire size as well as the tire type of the spare wheel or emergency spare wheel and the wheel to be replaced may differ. Mounting an emergency spare wheel may severely impair the driving characteristics. There is a risk of an accident.

To avoid hazardous situations:

- adapt your driving style accordingly and drive carefully.
- never install more than one spare wheel or emergency spare wheel that differs in size.
- only use a spare wheel or emergency spare wheel of a different size briefly.
- do not switch ESP® off.
- have a spare wheel or emergency spare wheel of a different size replaced at the nearest qualified specialist workshop. Observe that the wheel and tire dimensions as well as the tire type must be correct.

**Snow chains**

For safety reasons, Mercedes-Benz recommends that you only use snow chains that have been specially approved for your vehicle by Mercedes-Benz, or are of a corresponding standard of quality.

- ❗ On some tire sizes there is not enough space for snow chains. To avoid damage to the vehicle or tires, observe the "Wheel and tire combinations" section under "Tires and wheels".
- only use snow chains when driving on roads completely covered by snow. Do not exceed the maximum permissible speed of 30 mph (50 km/h). Remove the snow chains as soon as possible if you are driving on roads that are no longer snow-covered.
- local regulations may restrict the use of snow chains. Observe the appropriate

regulations if you wish to mount snow chains.

- snow chains may not be mounted on the emergency spare wheel.

If you intend to mount snow chains, please bear the following points in mind:

- snow chains may not be mounted on all wheel/tire combinations. Permitted wheel/tire combinations (▷ page 300).
- mount snow chains only in pairs and only on the rear wheels. Observe the manufacturer's mounting instructions.

❗ If snow chains are mounted on the front wheels, the snow chains could grind against the bodywork or components of the chassis. This could result in damage to the vehicle or the tires.

❗ **Vehicles with steel wheels:** if you wish to mount snow chains on steel wheels, make sure that you remove the respective wheels' hubcaps first. The hubcaps may otherwise be damaged.

i You may wish to deactivate ESP® (▷ page 60) when pulling away with snow chains mounted. This way you can allow the wheels to spin in a controlled manner, achieving an increased driving force (cutting action).

## Tire pressure

### Tire pressure specifications

#### WARNING

Tires with tire pressures that are too low or too high are associated with the following hazards:

- they can burst, in particular if the vehicle is heavily laden or when driven at high speeds.
- the tires can wear excessively and/or unevenly, which can severely impair tire traction.
- the driving, steering and braking characteristics may be severely impaired.

There is a risk of accident.

Follow recommended tire inflation pressures and check the pressure of all the tires including the spare wheel:

- monthly, at least
- if the load changes
- before beginning a long journey
- under different operating conditions, e.g. off-road driving

If necessary, correct the tire pressure.

The recommended tire pressures for the tires mounted at the factory can be found on the labels described here.

Option 1) **Tire and Loading Information placard** on the B-pillar on the driver's side of the vehicle (> page 287).

The Tire and Loading Information placard contains the recommended tire pressures for cold tires on a fully loaded vehicle and for the maximum permissible vehicle speed.

- i** The specifications given on the following Tire and Loading Information placard are examples. Tire pressure specifications are vehicle-specific and may deviate from the data shown here. The tire pressures applicable to your vehicle can be found on the Tire and Loading Information placard on your vehicle.

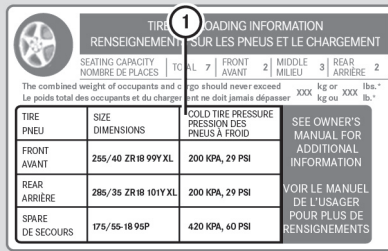

**TIRE LOADING INFORMATION**  
RENSEIGNEMENTS SUR LES PNEUS ET LE CHARGEMENT

SEATING CAPACITY / TOTAL: 7  
NUMBER OF SEATS / NOMBRE DE PLACES: 7

FRONT / AVANT: 2  
MIDDLE / MILIEU: 3  
REAR / ARRIERE: 2

The combined weight of occupants and cargo should never exceed XXX kg or XXX lbs. / Le poids total des occupants et du chargement ne doit jamais dépasser XXX kg ou XXX lbs.

TIRE / PNEU	SIZE / DIMENSIONS	COLD TIRE PRESSURE / PRESSION DES PNEUS A FROID	SEE OWNER'S MANUAL FOR ADDITIONAL INFORMATION / VOIR LE MANUEL DE L'USAGER POUR PLUS DE RENSEIGNEMENTS
FRONT / AVANT	255/40 ZR18 99Y XL	200 KPA, 29 PSI	
REAR / ARRIERE	285/35 ZR18 101Y XL	200 KPA, 29 PSI	
SPARE / DE SECOURS	175/55-18 95P	420 KPA, 60 PSI	

P40.00-2205-31

#### ① Recommended tire pressures

Option 2) **Tire pressure table** on the inside of the fuel filler flap.

The tire pressure table contains the recommended pressures for cold tires for various operating conditions, i.e. differing load and speed conditions.

- i** Specifications shown in the examples of tire pressure tables are for illustration purposes only. Tire pressure specifications are vehicle-specific and may deviate from the data shown here. Tire pressure specifications applicable to your vehicle are located in your vehicle's tire pressure table.

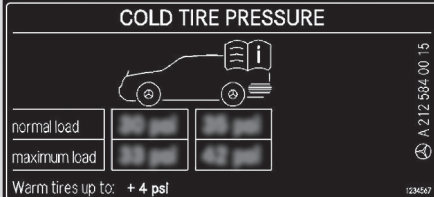

**COLD TIRE PRESSURE**

normal load: 250 psi / 170 kPa (front), 250 psi / 170 kPa (rear)

maximum load: 250 psi / 170 kPa (front), 250 psi / 170 kPa (rear)

Warm tires up to: + 4 psi

A 212 534 00 15

1234567

P40.00-2179-31

Example: tire pressure table for all tires permitted for this vehicle by the factory

If a tire size precedes a tire pressure, the tire pressure information following is only valid for that tire size. The load conditions "partially laden" and "fully laden" are defined in the table for different numbers of occupants and amounts of luggage. The actual number of seats may differ.

LUFTDRUCK PRESSURE PRESSION PRESIÓN			
für kalte Reifen for cold tires des pneus froids de Inflado			
100 kPa = 1 bar			
		kPa	psi
195/55 R16			
215/45 R17			
215/40 R18			
Warme Reifen bis: Warm tires up to:		+ 30 kPa + 4 psi	
		Pneus échauffés jusqu'à: Neumáticos calientes hasta:	

A 169 584 50 17

P40.00-2183-31

Example: tire pressure table with tire dimensions  
Some tire pressure tables show only the rim diameters instead of the full tire size, e.g. **R18**. The rim diameter is part of the tire size and can be found on the tire sidewall (▷ page 294).

Luftdruck für kalte Reifen Tire pressure cold tires Pression des pneus froids Presión de inflado			
100 kPa = 1 bar			
		kPa	psi
R18			
R19			
bis up to / jusqu'à / hasta 240 km/h / 150 mph		Winterreifen: Winter tires: Pneus hiver: Neumáticos de invierno: + 30 kPa + 4 psi	
Warme Reifen bis: Warm tires up to:		+ 30 kPa + 4 psi	
		Pneus échauffés jusqu'à: Neumáticos calientes hasta:	

A 212 584 02 17

P40.00-2184-31

If the tire pressures have been set to the lower values for lighter loads and/or lower road speeds, the pressures should be reset to the higher values:

- if you want to drive with an increased load and/or
  - if you want to drive at higher road speeds.
- i** The tire pressures for increased loads and/or higher road speeds, shown in the tire pressure table, may have a negative effect on driving comfort.

Option 3) The **tire pressure for the emergency/collapsible spare wheel** (depending on vehicle equipment) can be found:

- printed in yellow on the rim of the emergency/collapsible spare wheel
- in the "Wheel and tire combinations" section (▷ page 300) in this Operator's Manual
- on the Tire and Loading Information placard on the B-pillar on the driver's side.

If the tire pressure is not set correctly, this can lead to an excessive build up of heat and a sudden loss of pressure.

For more information, contact a qualified specialist workshop.

### Important notes on tire pressure

#### WARNING

If the tire pressure drops repeatedly, the wheel, valve or tire may be damaged. Tire pressure that is too low may result in a tire blow-out. There is a risk of an accident.

- Check the tire for foreign objects.
- Check whether the wheel is losing air or the valve is leaking.

If you are unable to rectify the damage, contact a qualified specialist workshop.

#### WARNING

If you fit unsuitable accessories onto tire valves, the tire valves may be overloaded and malfunction, which can cause tire pressure loss. Due to their design, retrofitted tire pressure monitors keep the tire valve open. This can also result in tire pressure loss. There is a risk of an accident.

Only screw the standard valve cap or other valve caps approved by Mercedes-Benz for your vehicle onto the tire valve.

To test tire pressure, use a suitable tire pressure gauge. The outer appearance of a tire does not permit any reliable conclusion



about the tire pressure. On vehicles equipped with the electronic tire pressure monitoring system, the tire pressure can be checked using the on-board computer.

The tire temperature and pressure increase when the vehicle is in motion. This is dependent on the driving speed and the load. Therefore, you should only correct tire pressures when the tires are cold.

The tires are cold:

- if the vehicle has been parked without direct sunlight on the tires for at least three hours and
- if the vehicle has not been driven further than 1 mile (1.6 km)

The tire temperature changes depending on the outside temperature, the vehicle speed and the tire load. If the tire temperature changes by 18 °F (10 °C), the tire pressure changes by approximately 10 kPa (0.1 bar/ 1.5 psi). Take this into account when checking the pressure of warm tires and only correct the tire pressure if it is too low for the current operating conditions. If you check the tire pressure when the tires are warm, the resulting value will be higher than if the tires were cold. This is normal. Do not reduce the tire pressure to the value specified for cold tires. The tire pressure would otherwise be too low.

Observe the recommended tire pressures for cold tires:

- on the Tire and Loading Information placard on the B-pillar on the driver's side
- in the tire pressure table on the inside of the fuel filler flap
- printed in yellow on the rim of the emergency/collapsible spare wheel (depending on vehicle equipment)

## Underinflated or overinflated tires

### Underinflation

#### WARNING

Tires with pressure that is too low can overheat and burst as a consequence. In addition, they also suffer from excessive and/ or irregular wear, which can severely impair the braking properties and the driving characteristics. There is a risk of an accident.

Avoid tire pressures that are too low in all the tires, including the spare wheel.

Underinflated tires may:

- wear quickly and unevenly
- have an adverse effect on fuel consumption
- overheat, leading to tire defects
- have an adverse effect on handling characteristics

### Overinflation

#### WARNING

Tires with excessively high pressure can burst because they are damaged more easily by road debris, potholes etc. In addition, they also suffer from irregular wear, which can severely impair the braking properties and the driving characteristics. There is a risk of an accident.

Avoid tire pressures that are too high in all the tires, including the spare wheel.

Overinflated tires may:

- have an adverse effect on handling characteristics
- wear quickly and unevenly
- be more susceptible to damage
- have an adverse effect on ride comfort
- increase the braking distance

### Maximum tire pressures

Never exceed the maximum permissible tire inflation pressure. Always observe the



recommended tire pressure for your vehicle when adjusting the tire pressure (▷ page 280).

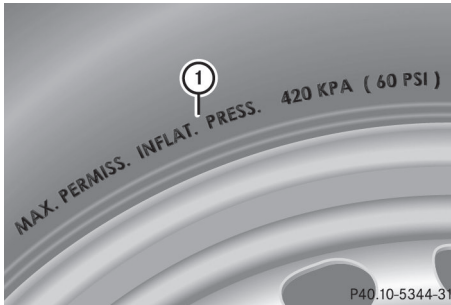

- ① Example: maximum permissible tire pressure
- i** The actual values for tires are vehicle-specific and may deviate from the values in the illustration.

### Checking the tire pressures

#### Important safety notes

Observe the "Tire pressure information" section (▷ page 280).

Information on air pressure for the tires on your vehicle can be found:

- on the vehicle's Tire and Loading Information placard on the B-pillar
- on the tire pressure label on the fuel filler flap
- in the "Tire pressure information" section

#### Checking tire pressures manually

To determine and set the correct tire pressure, proceed as follows:

- ▶ Remove the valve cap of the tire that is to be checked.
- ▶ Press the tire pressure gauge securely onto the valve.
- ▶ Read the tire pressure and compare it with the recommended value on the Tire and Loading Information placard on the B-pillar on the driver's side of your vehicle.

- ▶ If necessary, increase the tire pressure to the recommended value (▷ page 280).
- ▶ If the tire pressure is too high, release air by pressing down the metal pin in the valve using the tip of a pen, for example. Then check the tire pressure again using the tire pressure gauge.
- ▶ Screw the valve cap onto the valve.
- ▶ Repeat these steps for the other tires.

### Tire pressure loss warning system (Canada only)

#### Important safety notes

While the vehicle is in motion, the tire pressure loss warning system monitors the set tire pressure using the rotational speed of the wheels. This enables the system to detect significant pressure loss in a tire. If the speed of rotation of a wheel changes as a result of a loss of pressure, a corresponding warning message will appear in the multifunction display.

The tire pressure warning system does not warn you of an incorrectly set tire pressure. Observe the notes on the recommended tire pressure (▷ page 280).

The tire pressure loss warning system does not replace the need to regularly check your vehicle's tire pressures, since an even loss of pressure on several tires at the same time cannot be detected by the tire pressure loss warning system.

The tire pressure monitor is not able to warn you of a sudden loss of pressure, e.g. if the tire is penetrated by a foreign object. In the event of a sudden loss of pressure, bring the vehicle to a halt by braking carefully. Avoid abrupt steering maneuvers.

The function of the tire pressure loss warning system is limited or delayed if:

- snow chains are mounted to your vehicle's tires.
- road conditions are wintry.





- you are driving on sand or gravel.
- you adopt a very sporty driving style (cornering at high speeds or driving with high rates of acceleration).
- you are driving with a heavy load (in the vehicle or on the roof).

### Restarting the tire pressure loss warning system





Restart the tire pressure loss warning system if you have:

- changed the tire pressure
- changed the wheels or tires
- mounted new wheels or tires
- ▶ Before restarting, consult the Tire and Loading Information placard on the B-pillar on the driver's side or the tire pressure table on the inside of the fuel filler flap to ensure the tire pressure in all four tires is set correctly for the current operating conditions.

The tire pressure loss warning system can only give reliable warnings if you have set the correct tire pressure. If an incorrect tire pressure is set, these incorrect values will be monitored.





- ▶ Observe the notes in the section on tire pressures (▷ page 280).
- ▶ Make sure that the SmartKey is in position 2 (▷ page 125) in the ignition lock.
- ▶ Press the  or  button to select the **Service** menu.
- ▶ Press the  or  button to select **Tire Pressure**.
- ▶ Press the  button.  
The **Run Flat Indicator Active Press 'OK' to Restart** message appears in the multifunction display.

### If you wish to confirm the restart:

- ▶ Press the  button.  
The **Tire Pressure Now OK?** message appears in the multifunction display.
- ▶ Press the  or  button to select **Yes**.
- ▶ Press the  button.  
The **Run Flat Indicator Restarted** message appears in the multifunction display.

After a teach-in period, the tire pressure loss warning system will monitor the set tire pressures of all four tires.

### If you wish to cancel the restart:

- ▶ Press the  button.
- or
- ▶ If the **Tire Pressure Now OK?** message appears, press the  or  button to select **Cancel**.
- ▶ Press the  button.  
The tire pressure values stored at the last restart will continue to be monitored.

## Tire pressure monitor

### Important safety notes

It is the driver's responsibility to set the tire pressure to that recommended for cold tires which is suitable for the operating situation (▷ page 280). Note that the correct tire pressure for the current operating situation must first be taught-in to the tire pressure monitor. If there is a substantial loss of pressure, the warning threshold for the warning message is aligned to the reference values taught-in. Restart the tire pressure monitor after adjusting the pressure of the cold tires (▷ page 287). The current pressures are saved as new reference values. As a result, a warning message will appear if the tire pressure drops significantly.

The tire pressure monitor does not warn you of an incorrectly set tire pressure. Observe

the notes on the recommended tire pressure (▷ page 280).

The tire pressure monitor is not able to warn you of a sudden loss of pressure, e.g. if the tire is penetrated by a foreign object. In the event of a sudden loss of pressure, bring the vehicle to a halt by braking carefully. Avoid abrupt steering maneuvers.

If a tire pressure monitor system is installed, the vehicle's wheels have sensors that monitor the tire pressures in all four tires. The tire pressure monitor warns you if the pressure drops in one or more of the tires. The tire pressure monitor only functions if the correct sensors are installed to all wheels.

The tire pressure monitor has a yellow warning lamp in the instrument cluster for indicating pressure loss/malfunctions (USA) or pressure loss (Canada). Whether the warning lamp flashes or lights up indicates whether a tire pressure is too low or the tire pressure monitoring system is malfunctioning:

- if the warning lamp is lit continuously, the tire pressure on one or more tires is significantly too low. The tire pressure monitor is not malfunctioning.
- USA only: if the warning lamp flashes for around a minute and then remains lit constantly, the tire pressure monitor is malfunctioning.

#### **WARNING**

Each tire, including the spare (if provided), should be checked at least once a month when cold and inflated to the pressure recommended by the vehicle manufacturer on the Tire and Loading Information placard on the driver's door B-pillar or the tire pressure label on the inside of the fuel filler flap. If your vehicle has tires of a different size than the size indicated on the Tire and Loading Information placard or the tire pressure label, you should determine the proper tire pressure for those tires.

As an added safety feature, your vehicle has been equipped with a tire pressure monitoring

system (TPMS) that illuminates a low tire pressure telltale when one or more of your tires are significantly underinflated.

Accordingly, when the low tire pressure telltale illuminates, you should stop and check your tires as soon as possible, and inflate them to the proper pressure. Driving on a significantly underinflated tire causes the tire to overheat and can lead to tire failure.

Underinflation also reduces fuel efficiency and tire tread life, and may affect the vehicle's handling and stopping ability.

Please note that the TPMS is not a substitute for proper tire maintenance, and it is the driver's responsibility to maintain correct tire pressure, even if underinflation has not reached the level to trigger illumination of the TPMS low tire pressure telltale.

USA only:

Your vehicle has also been equipped with a TPMS malfunction indicator to indicate if the system is not operating properly. The TPMS malfunction indicator is combined with the low tire pressure telltale. When the system detects a malfunction, the warning lamp will flash for approximately a minute and then remain continuously illuminated. This sequence will be repeated every time the vehicle is started as long as the malfunction exists.

When the malfunction indicator is illuminated, the system may not be able to detect or signal low tire pressure as intended. TPMS malfunctions may occur for a variety of reasons, including the installation of incompatible replacement or alternate tires or wheels on the vehicle that prevent the TPMS from functioning properly. Always check the TPMS malfunction telltale after replacing one or more tires or wheels on your vehicle to ensure that the replacement or alternate tires and wheels allow the TPMS to continue to function properly.

 USA only:

If the tire pressure monitor is malfunctioning, it may take more than ten

minutes for the tire pressure warning lamp to inform you of the malfunction by flashing for approximately one minute and then remaining lit.

When the malfunction has been rectified, the tire pressure warning lamp goes out after a few minutes of driving.

Information on tire pressures is displayed in the multifunction display. After a few minutes of driving, the current tire pressure of each tire is shown in the multifunction display.

**i** The tire pressure values indicated by the on-board computer may differ from those measured at a gas station with a pressure gauge. The tire pressures shown by the on-board computer refer to those measured at sea level. At high altitudes, the tire pressure values indicated by a pressure gauge are higher than those shown by the on-board computer. In this case, do not reduce the tire pressures.

**i** The operation of the tire pressure monitor can be affected by interference from radio transmitting equipment (e.g. radio headphones, two-way radios) that may be being operated in or near the vehicle.

**i** USA only:

This device complies with part 15 of the FCC Rules. Operation is subject to the following two conditions:

1. This device may not cause harmful interference, and
2. this device must accept any interference received, including interference that may cause undesired operation of the device.

Any unauthorized modification to this device could void the user's authority to operate the equipment.

**i** Canada only:





This device complies with RSS-210 of Industry Canada. Operation is subject to the following two conditions:

1. This device may not cause harmful interference, and

2. this device must accept any interference received, including interference that may cause undesired operation of the device.

Any unauthorized modification to this device could void the user's authority to operate the equipment.

### Checking tire pressure electronically

- ▶ Make sure that the SmartKey is in position 2 (▶ page 125) in the ignition lock.
- ▶ Press the  or  button on the steering wheel to select the **Service** menu.
- ▶ Press the  or  button to select **Tire Pressure**.
- ▶ Press the  button.

The current tire pressure for each wheel will be displayed in the multifunction display.

If the vehicle has been parked for longer than 20 minutes, the **Tire pressures will be displayed after driving a few minutes** message appears.

After a teach-in period, the tire pressure monitor automatically recognizes new wheels or new sensors. As long as a clear allocation of the tire pressure values to the individual wheels is not possible, the **Tire Pressure Monitor Active** display message is shown instead of the tire pressure display. The tire pressures are already being monitored.

**i** If a spare wheel/emergency spare wheel is mounted, the system may continue to show the tire pressure of the wheel that has been removed for a few minutes. If this occurs, note that the value displayed for the position where the spare tire is mounted is not the same as the spare wheel/emergency spare wheel's current tire pressure.

### Tire pressure monitor warning messages

If the tire pressure monitor detects a significant pressure loss on one or more tires,

a warning message is shown in the multifunction display. A warning tone also sounds and the tire pressure warning lamp lights up in the instrument cluster. Each tire that is affected by a significant loss of pressure is highlighted with a color. If the **Correct tire pressure** message appears in the multifunction display:



- ▶ Check the tire pressure on all four wheels and correct it if necessary.





**i** If the wheel positions on the vehicle are interchanged, the tire pressures may be displayed for the wrong positions for a short time. This is rectified after a few minutes of driving, and the tire pressures are displayed for the correct positions.

### Restarting the tire pressure monitor

When you restart the tire pressure monitor, all existing warning messages are deleted and the warning lamps go out. The monitor uses the currently set tire pressures as the reference values for monitoring. In most cases, the tire pressure monitoring system recognizes the new reference values automatically.

However, you can also define reference values manually as described here:

- ▶ Set the tire pressure to the value recommended for the corresponding driving situation on the vehicle's Tire and Loading Information placard on the driver's side B-pillar(▷ page 280).  
Additional tire pressure values for driving at high speeds or with heavy loads can be found in the tire pressure table on the inside of the fuel filler flap.
- ▶ Make sure that the tire pressure is correct on all four wheels.
- ▶ Make sure that the SmartKey is in position **2** in the ignition lock.
- ▶ Press the  or  button on the steering wheel to select the **Service** menu.

- ▶ Press the  or  button to select **Tire Pressure**.
- ▶ Press the  button.  
The multifunction display shows the current tire pressure of the individual tires or the **Tire pressures will be displayed after driving a few minutes** message.
- ▶ Press the  button.  
The **Use Current Pressures as New Reference Values** message appears in the multifunction display.

### If you wish to confirm the restart:

- ▶ Press the  button.  
The **Tire Press. Monitor Restarted** message appears in the multifunction display.

After driving for a few minutes, the system checks whether the current tire pressures are within the specified range. The new tire pressures are then accepted as reference values and monitored.

### If you wish to cancel the restart:

- ▶ Press the  button.  
The tire pressure values stored at the last restart will continue to be monitored.

## Loading the vehicle

### Instruction labels for tires and loads

#### **WARNING**

Overloaded tires can overheat, causing a blowout. Overloaded tires can also impair the steering and driving characteristics and lead to brake failure. There is a risk of accident.

Observe the load rating of the tires. The load rating must be at least half of the GAWR of your vehicle. Never overload the tires by exceeding the maximum load.

Two instruction labels on your vehicle show the maximum possible load.

- (1) The Tire and Loading Information placard is on the B-pillar on the driver's side. The Tire and Loading Information placard shows the maximum permissible number of occupants and the maximum permissible vehicle load. It also contains details of the tire sizes and corresponding pressures for tires installed at the factory.
- (2) The vehicle identification plate is on the B-pillar on the driver's side. The vehicle identification plate informs you of the gross vehicle weight rating. It is made up of the vehicle weight, all vehicle occupants, the fuel and the cargo. You can also find information about the maximum gross axle weight rating on the front and rear axle.

The maximum gross axle weight rating is the maximum weight that can be carried by one axle (front or rear axle). Never exceed the maximum load or the maximum gross axle weight rating for the front or rear axle.

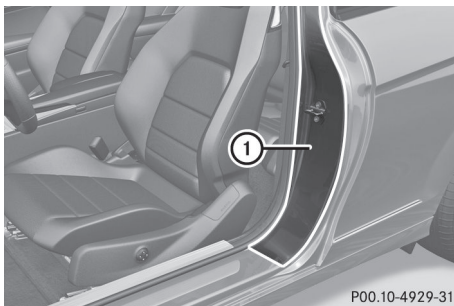

P00.10-4929-31

- ① B-pillar, driver's side

### Maximum permissible load

- ① The specifications shown on the Tire and Loading Information placard in the illustration are examples. The maximum permissible load is vehicle-specific and may deviate from the data shown here. The

maximum permissible load that applies for your vehicle can be found on your vehicle's Tire and Loading Information placard.

TIRE RENSEIGNEMENTS		LOADING INFORMATION	
RENSEIGNEMENTS SUR LES PNEUS ET LE CHARGEMENT		SUR LES PNEUS ET LE CHARGEMENT	
SEATING CAPACITY NOMBRE DE PLACES	TOTAL 7	FRONT AVANT 2	MIDDLE MILIEU 3
The combined weight of occupants and cargo should never exceed Le poids total des occupants et du chargement ne doit jamais dépasser		XXX kg or XXX lbs.*	REAR ARRIÈRE 2
TIRE PNEU	SIZE DIMENSIONS	COLD TIRE PRESSURE PRESSION DES PNEUS À FROID	SEE OWNER'S MANUAL FOR ADDITIONAL INFORMATION
FRONT AVANT	255/40 ZR18 99Y XL	200 KPA, 29 PSI	VOIR LE MANUEL DE L'USAGER POUR PLUS DE RENSEIGNEMENTS
REAR ARRIÈRE	285/35 ZR18 101Y XL	200 KPA, 29 PSI	
SPARE DE SECOURS	175/55-18 95P	420 KPA, 60 PSI	

P40.00-2206-31

- Specification for maximum permissible load ① is listed on the Tire and Loading Information placard: "The gross weight of occupants and luggage must not exceed XXX kg or XXX lbs."

The gross weight of all vehicle occupants, load, luggage and trailer load/noseweight (if applicable) must not exceed the specified value.

### Number of seats

- ① The specifications shown on the Tire and Loading Information placard in the illustration are examples. The number of seats is vehicle-specific and can differ from the details shown. The number of seats in your vehicle can be found on the Tire and Loading Information placard.

TIRE RENSEIGNEMENTS		LOADING INFORMATION	
RENSEIGNEMENTS SUR LES PNEUS ET LE CHARGEMENT		SUR LES PNEUS ET LE CHARGEMENT	
SEATING CAPACITY NOMBRE DE PLACES	TOTAL 7	FRONT AVANT 2	MIDDLE MILIEU 3
The combined weight of occupants and cargo should never exceed Le poids total des occupants et du chargement ne doit jamais dépasser		XXX kg or XXX lbs.*	REAR ARRIÈRE 2
TIRE PNEU	SIZE DIMENSIONS	COLD TIRE PRESSURE PRESSION DES PNEUS À FROID	SEE OWNER'S MANUAL FOR ADDITIONAL INFORMATION
FRONT AVANT	255/40 ZR18 99Y XL	200 KPA, 29 PSI	VOIR LE MANUEL DE L'USAGER POUR PLUS DE RENSEIGNEMENTS
REAR ARRIÈRE	285/35 ZR18 101Y XL	200 KPA, 29 PSI	
SPARE DE SECOURS	175/55-18 95P	420 KPA, 60 PSI	

P40.00-2207-31

Maximum number of seats ① determines the maximum number of occupants allowed to

travel in the vehicle. This information can be found on the Tire and Loading Information placard.

### Determining the correct load limit

#### Step-by-step instructions

The following steps have been developed as required of all manufacturers under Title 49, Code of U.S. Federal Regulations, Part 575 pursuant to the "National Traffic and Motor Vehicle Safety Act of 1966".

- ▶ **Step 1:** Locate the statement "The combined weight of occupants and cargo should never exceed XXX kg or XXX lbs." on your vehicle's Tire and Loading Information placard.
- ▶ **Step 2:** Determine the combined weight of the driver and passengers that will be riding in your vehicle.
- ▶ **Step 3:** Subtract the combined weight of the driver and passengers from XXX kilograms or XXX lbs.
- ▶ **Step 4:** The resulting figure equals the available amount of cargo and luggage load capacity. For example, if the "XXX" amount equals 1400 lbs and there will be five 150 lbs passengers in your vehicle, the amount of available cargo and luggage load capacity is 650 lbs (1 400 - 750 (5 x 150) = 650 lbs).
- ▶ **Step 5:** Determine the combined weight of luggage and cargo being loaded on the vehicle. That weight may not safely exceed the available cargo and luggage load capacity calculated in step 4.
- ▶ **Step 6 (if applicable):** If your vehicle will be towing a trailer, load from your trailer will be transferred to your vehicle. Consult this manual to determine how this reduces the available cargo and luggage load capacity of your vehicle (▷ page 291).



**Example: steps 1 to 3**

The following table shows examples on how to calculate total and cargo load capacities with varying seating configurations and number and size of occupants. The following examples use a load limit of 1 500 lbs (680 kg). **This is for illustration purposes only.** Make sure you are using the actual load limit for your vehicle stated on your vehicle's Tire and Loading Information placard (▷ page 288).

		Example 1	Example 2	Example 3
<b>Step 1</b>	<b>Combined maximum weight of occupants and cargo (data from the Tire and Loading Information placard)</b>	1500 lbs (680 kg)	1500 lbs (680 kg)	1500 lbs (680 kg)

		Example 1	Example 2	Example 3
<b>Step 2</b>	<b>Number of people in the vehicle (driver and occupants)</b>	5	3	1
	<b>Distribution of the occupants</b>	Front: 2 Rear: 3	Front: 1 Rear: 2	Front: 1
	<b>Weight of the occupants</b>	Occupant 1: 150 lbs (68 kg) Occupant 2: 180 lbs (82 kg) Occupant 3: 160 lbs (73 kg) Occupant 4: 140 lbs (63 kg) Occupant 5: 120 lbs (54 kg)	Occupant 1: 200 lbs (91 kg) Occupant 2: 190 lbs (86 kg) Occupant 3: 150 lbs (68 kg)	Occupant 1: 150 lbs (68 kg)
	<b>Gross weight of all occupants</b>	750 lbs (340 kg)	540 lbs (245 kg)	150 lbs (68 kg)



		Example 1	Example 2	Example 3
<b>Step 3</b>	<b>Permissible load and trailer load/noseweight (maximum permissible load rating from the Tire and Loading Information placard minus the gross weight of all occupants)</b>	1500 lbs (680 kg) - 750 lbs (340 kg) = 750 lbs (340 kg)	1500 lbs (680 kg) - 540 lbs (245 kg) = 960 lbs (435 kg)	1500 lbs (680 kg) - 150 lbs (68 kg) = 1350 lbs (612 kg)

The higher the weight of all the occupants, the smaller the maximum load for luggage. Further information can be found under "Towing a trailer" (▷ page 291).

### Vehicle identification plate

Even if you have calculated the total load carefully, you should still make sure that the gross vehicle weight rating and the gross axle weight rating are not exceeded. Details can be found on the vehicle identification plate on the B-pillar on the driver's side of the vehicle (▷ page 287).

**Permissible gross vehicle weight:** the gross weight of the vehicle, all passengers, load and trailer load/noseweight (if applicable) must not exceed the permissible gross vehicle weight.

**Gross axle weight rating:** the maximum permissible weight that can be carried by one axle (front or rear axle).

To ensure that your vehicle does not exceed the maximum permissible values (gross vehicle weight and maximum gross axle weight rating), have your loaded vehicle (including driver, occupants, cargo, and full trailer load if applicable) weighed on a suitable vehicle weighbridge.

### Trailer load/noseweight

Your Mercedes-Benz has been designed primarily to carry passengers and their

luggage. Mercedes-Benz does not recommend towing a trailer with your vehicle.

### Maximum load rating

Do not overload the tires by exceeding the specified load limit. The maximum permissible load can be found on the vehicle's Tire and Loading Information placard on the B-pillar on the driver's side (▷ page 287).

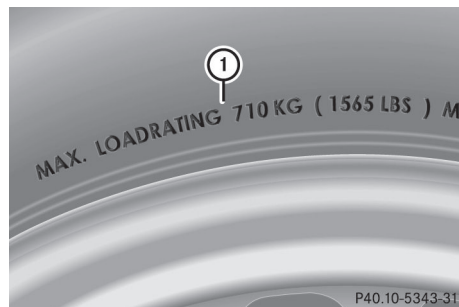

**i** The actual values for tires are vehicle-specific and may deviate from the values in the illustration.

Maximum tire load ① is the maximum permissible weight for which the tire is approved.

## Uniform Tire Quality Grading Standards

### Overview of Tire Quality Grading Standards

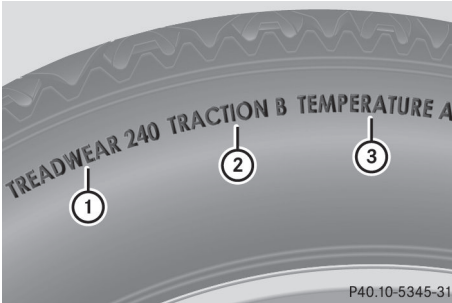

Uniform Tire Quality Grading Standards are U.S. government specifications. Their purpose is to provide drivers with uniform reliable information on tire performance data. Tire manufacturers have to grade tires using three performance factors: tread wear ①, tire traction ②, and heat resistance ③. All tires sold in North America are provided with the corresponding quality class mark on the sidewall of the tire, even though these regulations do not apply to Canada.

**i** The actual values for tires are vehicle-specific and may deviate from the values in the illustration.

Where applicable, the tire grading information can be found on the tire sidewall between the tread shoulder and maximum tire width.

For example:

Tread wear	Traction	Temperature
200	AA	A

All passenger car tires must conform to the statutory safety requirements in addition to these grades.

### Tread wear

The tread wear grade is a comparative rating based on the wear rate of the tire when tested under controlled conditions on a specified U.S. government course. For example, a tire graded 150 would wear one and one-half times as well on the government course as a tire graded 100.

The relative performance of tires depends upon the actual conditions of their use, however, and may depart significantly from the norm, due to variations in driving habits, service practices and differences in road characteristics and climate conditions.

### Traction

#### WARNING

The traction grade assigned to this tire is based on straight-ahead braking traction tests, and does not include acceleration, cornering, hydroplaning, or peak traction characteristics.

The traction grades, from highest to lowest, are AA, A, B, and C. Those grades represent the tire's ability to stop on a wet surface as measured under controlled conditions on specified government test surfaces of asphalt and concrete. A tire marked C may have poor traction performance.

The safe speed on a wet, snow covered or icy road is always lower than on dry road surfaces.

You should pay special attention to road conditions when temperatures are around the freezing point.

Mercedes-Benz recommends a minimum tread depth of  $\frac{1}{8}$  in (4 mm) for all four winter tires (> page 278) to maintain normal driving characteristics in winter. Winter tires can reduce the braking distance on snow-covered surfaces in comparison with summer tires. Stopping distance, however, is still considerably greater than when the road is

not covered with ice or snow. Take appropriate care when driving.

- ❗ Avoid wheelspin. This can lead to damage to the drive train.

### Temperature

#### ⚠ WARNING

The temperature grade for this tire is established for a tire that is properly inflated and not overloaded. Excessive speed, underinflation, or excessive loading, either separately or in combination, can cause excessive heat build-up and possible tire failure.

The temperature grades are A (the highest), B, and C. These represent the tire's resistance to the generation of heat and its ability to dissipate heat when tested under controlled conditions on a specified indoor laboratory test wheel. Sustained high temperature can cause the material of the tire to degenerate and reduce tire life, and excessive temperature can lead to sudden tire failure. The grade C corresponds to a level of performance which all passenger car tires must meet under the Federal Motor Vehicle Safety Standard No. 109. Grades B and A represent higher levels of performance on the laboratory test wheel than the minimum required by law.

### Tire labeling

#### Tire labeling overview

The following markings are on the tire in addition to the tire name (sales designation) and the manufacturer's name:

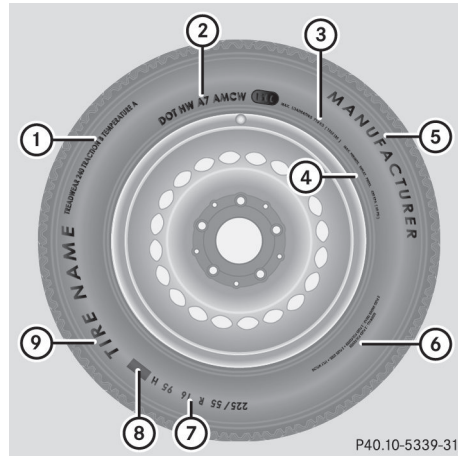

- ① Uniform tire Quality Grading Standard (> page 297)
  - ② DOT, Tire Identification Number (> page 296)
  - ③ Maximum tire load (> page 291)
  - ④ Maximum tire pressure (> page 282)
  - ⑤ Manufacturer
  - ⑥ Tire material (> page 297)
  - ⑦ Tire size designation, load-bearing capacity and speed rating (> page 294)
  - ⑧ Load index (> page 296)
  - ⑨ Tire name
- ❗ Tire data is vehicle-specific and may deviate from the data in the example.

### Tire size designation, load-bearing capacity and speed rating

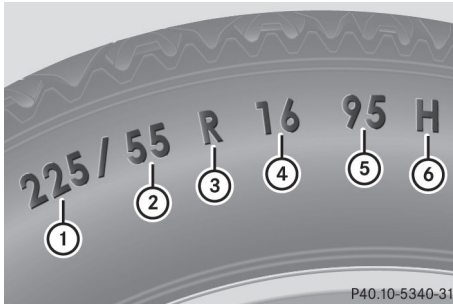

- ① Tire width
- ② Nominal aspect ratio in %
- ③ Tire code
- ④ Rim diameter
- ⑤ Load bearing index
- ⑥ Speed rating

**i** Tire data is vehicle-specific and may deviate from the data in the example.

**General:** depending on the manufacturer's standards, the size imprinted in the tire wall may not contain any letters or may contain one letter that precedes the size description.

If there is no letter preceding the size description (as shown above): these are passenger vehicle tires according to European manufacturing standards.

If "P" precedes the size description: these are passenger vehicle tires according to U.S. manufacturing standards.

If "LT" precedes the size description: these are light truck tires according to U.S. manufacturing standards.

If "T" precedes the size description: these are compact emergency spare wheels at high tire pressure, to be used only temporarily in an emergency.

**Tire width:** tire width ① shows the nominal tire width in millimeters.

**Height-width ratio:** aspect ratio ② is the size ratio between the tire height and tire width and is shown in percent. The aspect

ratio is calculated by dividing the tire width by the tire height.

**Tire code:** tire code ③ specifies the tire type. "R" represents radial tires; "D" represents diagonal tires; "B" represents diagonal radial tires.

Optionally, tires with a maximum speed of over 149mph (240km/h) may have "ZR" in the size description, depending on the manufacturer (e.g. 245/40 ZR 18).

**Rim diameter:** rim diameter ④ is the diameter of the bead seat, not the diameter of the rim flange. The rim diameter is specified in inches (in).

**Load-bearing index:** load-bearing index ⑤ is a numerical code that specifies the maximum load-bearing capacity of a tire.

Do not overload the tires by exceeding the specified load limit. The maximum permissible load can be found on the vehicle's Tire and Loading Information placard on the B-pillar on the driver's side (▷ page 287).

Example:

A load-bearing index of 91 indicates a maximum load of 1,356lb (615kg) that can be carried by the tires. For further information on the maximum tire load in kilograms and pounds, see (▷ page 291).

For further information on the load-bearing index, see Load index (▷ page 296).

**Speed rating:** speed rating ⑥ specifies the approved maximum speed of the tire.

#### **⚠ WARNING**

Exceeding the stated tire load-bearing capacity and the approved maximum speed could lead to tire damage or the tire bursting. There is a risk of accident.

Therefore, only use tire types and sizes approved for your vehicle model. Observe the tire load rating and speed rating required for your vehicle.

Regardless of the speed rating, always observe the speed limits. Drive carefully and

adapt your driving style to the traffic conditions.

Summer tires	
Index	Speed rating
Q	up to 100mph (160 km/h)
R	up to 106mph (170 km/h)
S	up to 112mph (180 km/h)
T	up to 118mph (190 km/h)
H	up to 130mph (210 km/h)
V	up to 149mph (240 km/h)
W	up to 168mph (270 km/h)
Y	up to 186mph (300 km/h)
ZR...Y	up to 186mph (300 km/h)
ZR...(..Y)	over 186mph (300 km/h)
ZR	over 149mph (240 km/h)

- Optionally, tires with a maximum speed of over 149 mph (240km/h) may have "ZR" in the size description, depending on the manufacturer (e.g. 245/40 ZR 18). The service specification is made up of load-bearing index (5) and speed rating (6).
- If the size description of your tire includes "ZR" and there are no service specifications, ask the tire manufacturer in order to find out the maximum speed. If a service specification is available, the maximum speed is limited according to the speed rating in the service specification. Example: 245/40 ZR 18 97 Y. In this example, "97 Y" is the service specification. The letter "Y" represents the speed rating and the maximum speed of the tire is limited to 186 mph (300km/h).
- The size description for all tires with maximum speeds of over 186mph

(300km/h) must include "ZR", **and** the service specification must be given in brackets. Example: 275/40 ZR 18 (99 Y). The speed rating "(Y)" indicates that the maximum speed of the tire is over 186mph (300km/h). Ask the tire manufacturer about the maximum speed.

All-weather tires and winter tires	
Index	Speed rating
Q M+S <sup>17</sup>	up to 100mph (160 km/h)
T M+S <sup>17</sup>	up to 118mph (190 km/h)
H M+S <sup>17</sup>	up to 130mph (210 km/h)
V M+S <sup>17</sup>	up to 149mph (240 km/h)

- i** Not all tires with the M+S marking provide the driving characteristics of winter tires. In addition to the M+S marking, winter tires also have the  snowflake symbol on the tire wall. Tires with this marking fulfill the requirements of the Rubber Manufacturers Association (RMA) and the Rubber Association of Canada (RAC) regarding snow traction, and were specially developed for driving on snow.

An electronic speed limiter prevents your vehicle from exceeding the following speeds:

- all vehicles (except AMG vehicles): 130 mph (210 km/h)
- AMG vehicles: 155 mph (250 km/h)
- AMG vehicles with increased top speed: 174 mph (280 km/h)

The speed rating of tires mounted at the factory may be higher than the maximum speed that the electronic speed limiter permits.

Make sure that your tires have the required speed rating for your vehicle as specified in the "Tires" section (▷ page 300), e.g. if you buy new tires.

<sup>17</sup> Or M+S  for winter tires.

Further information about reading tire data can be obtained from any qualified specialist workshop.

### Load index



**i** Tire data is vehicle-specific and may deviate from the data in the example.

In addition to the load bearing index, load index ① may be imprinted after the letters that identify speed rating ⑥ (▷ page 294) on the sidewall of the tire.

- If no specification is given: no text (as in the example above), represents a standard load (SL) tire
- XL or Extra Load: represents a reinforced tire
- Light load: represents a light load tire
- C, D, E: represents a load range that depends on the maximum load that the tire can carry at a certain pressure

### DOT, Tire Identification Number (TIN)

U.S. tire regulations prescribe that every manufacturer of new tires or retreader has to imprint a TIN in or on the sidewall of each tire produced.

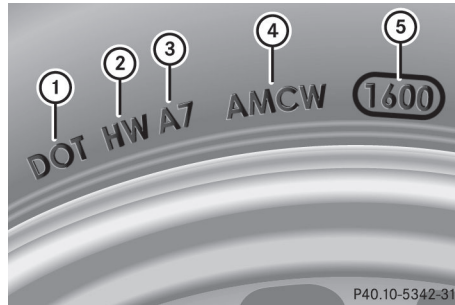

The TIN is a unique identification number. The TIN enables the tire manufacturers to inform purchasers of recalls and other safety-relevant matters. It makes it possible for the purchaser to easily identify the affected tires. The TIN is made up of manufacturer identification code ②, tire size ③, tire type code ④ and manufacturing date ⑤.

**i** Tire data is vehicle-specific and may deviate from the data in the example.

**DOT (Department of Transportation):** tire symbol ① indicates that the tire complies with the requirements of the U.S. Department of Transportation.

**Manufacturer identification code:** manufacturer identification code ② provides details on the tire manufacturer. New tires have a code with two symbols. Retreaded tires have a code with four symbols.

Further information about retreaded tires (▷ page 276).

**Tire size:** identifier ③ describes the tire size.

**Tire type code:** tire type code ④ can be used by the manufacturer as a code to describe specific characteristics of the tire.

**Date of manufacture:** date of manufacture ⑤ provides information about the age of a tire. The first and second positions represent the week of manufacture, starting with "01" for the first calendar week. Positions three and four represent the year of manufacture. For example, a tire that is marked with "3208", was manufactured in week 32 in 2008.

### Tire characteristics

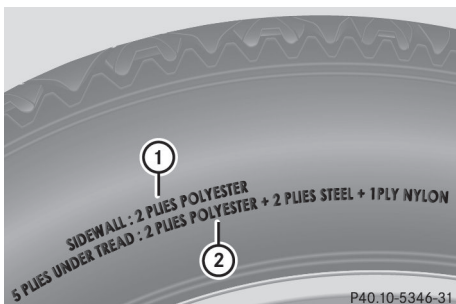

**i** Tire data is vehicle-specific and may deviate from the data in the example.

This information describes the tire cord and the number of layers in sidewall ① and under the tread ②.

### Definition of terms for tires and loading

#### Tire ply composition and material used

Describes the number of plies or the number of layers of rubber-coated fabric in the tire tread and sidewall. These are made of steel, nylon, polyester and other materials.

#### Bar

Metric unit for tire pressure. 14.5038 pounds per square inch (psi) and 100 kilopascals (kPa) are the equivalent of 1 bar.

#### DOT (Department of Transportation)

DOT marked tires fulfill the requirements of the United States Department of Transportation.

#### Normal occupant weight

The number of occupants the vehicle is designed to seat, multiplied by 68 kilograms (150 lb).

#### Uniform Tire Quality Grading Standards

A uniform standard to grade the quality of tires with regards to tread quality, tire traction and temperature characteristics. Ratings are determined by tire manufacturers using U.S. government testing procedures. The ratings are molded into the sidewall of the tire.

#### Recommended tire pressure

The recommended tire pressure applies to the tires mounted at the factory.

The Tire and Loading Information placard contains the recommended tire pressures for cold tires on a fully loaded vehicle and for the maximum permissible vehicle speed.

The tire pressure table contains the recommended pressures for cold tires for various operating conditions, i.e. differing load and speed conditions.

#### Increased vehicle weight due to optional equipment

This is the combined weight of all standard and optional equipment available for the vehicle, regardless of whether it is actually installed on the vehicle or not.

#### Rim

This is the part of the wheel on which the tire is mounted.



**GAWR (Gross Axle Weight Rating)**

The GAWR is the maximum permissible axle load. The actual load on an axle must never exceed the gross axle weight rating. The gross axle weight rating can be found on the vehicle identification plate on the B-pillar on the driver's side.

**Speed rating**

The speed rating is part of the tire identification. It specifies the speed range for which the tire is approved.

**GVW (Gross Vehicle Weight)**

The gross vehicle weight includes the weight of the vehicle including fuel, tools, the spare wheel, accessories installed, occupants, luggage and the drawbar noseweight, if applicable. The gross vehicle weight must not exceed the gross vehicle weight rating GVWR as specified on the vehicle identification plate on the B-pillar on the driver's side.

**GVWR (Gross Vehicle Weight Rating)**

The GVWR is the maximum permissible gross weight of a fully loaded vehicle (the weight of the vehicle including all accessories, occupants, fuel, luggage and the drawbar noseweight, if applicable). The gross vehicle weight rating is specified on the vehicle identification plate on the B-pillar on the driver's side.

**Maximum loaded vehicle weight**

The maximum weight is the sum of the curb weight of the vehicle, the weight of the accessories, the total load limit and the weight of the optional equipment installed at the factory.

**Kilopascal (kPa)**

Metric unit for tire pressure. 6.9 kPa corresponds to 1 psi. Another unit for tire pressure is bar. There are 100 kilopascals (kPa) to 1 bar.

**Load index**

In addition to the load-bearing index, the load index may also be imprinted on the sidewall of the tire. This specifies the load-bearing capacity more precisely.

**Curb weight**

The weight of a vehicle with standard equipment including the maximum capacity of fuel, oil and coolant. It also includes the air-conditioning system and optional equipment if these are installed in the vehicle, but does not include passengers or luggage.

**Maximum load rating**

The maximum load rating in kilograms or pounds is the maximum weight for which a tire is approved.

**Maximum permissible tire pressure**

Maximum permissible tire pressure for one tire.

**Maximum load on one tire**

Maximum load on one tire. This is calculated by dividing the maximum axle load of one axle by two.

**PSI (pounds per square inch)**

A standard unit of measure for tire pressure.



**Aspect ratio**

Relationship between tire height and tire width in percent.

**Tire pressure**

This is pressure inside the tire applying an outward force to each square inch of the tire's surface. The tire pressure is specified in pounds per square inch (psi), in kilopascal (kPa) or in bar. The tire pressure should only be corrected when the tires are cold.

**Tire pressure of cold tires**

The tires are cold:

- if the vehicle has been parked without direct sunlight on the tires for at least three hours and
- if the vehicle has not been driven more than 1 mile (1.6 km).

**Tread**

The part of the tire that comes into contact with the road.

**Bead**

The tire bead ensures that the tire sits securely on the wheel. There are several steel wires in the bead to prevent the tire from coming loose from the wheel rim.

**Sidewall**

The part of the tire between the tread and the bead.

**Weight of optional extras**

The combined weight of those optional extras that weigh more than the replaced standard part and more than 2.3 kg (5 lb). These

optional extras, such as high-performance brakes, level control, a roof rack or a high-performance battery, are not included in the curb weight and the weight of the accessories.

**TIN (Tire Identification Number)**

This is a unique identifier which can be used by a tire manufacturer to identify tires, for example for a product recall, and thus identify the purchasers. The TIN is made up of the manufacturer's identification code, tire size, tire type code and the manufacturing date.

**Load bearing index**

The load bearing index (also load index) is a code that contains the maximum load bearing capacity of a tire.

**Traction**

Traction is the result of friction between the tires and the road surface.

**Treadwear indicators**

Narrow bars (tread wear bars) that are distributed over the tire tread. If the tire tread is level with the bars, the wear limit of  $\frac{1}{16}$  in (1.6 mm) has been reached.

**Occupant distribution**

The distribution of occupants in a vehicle at their designated seating positions.

**Total load limit**

Rated cargo and luggage load plus 68 kilograms (150 lb), multiplied by the vehicle's designated seating capacity.

## Changing a wheel

### Flat tire

The "Breakdown assistance" section (▷ page 261) contains information and notes on how to deal with a flat tire. It also provides instructions on changing a wheel or mounting the spare wheel/emergency spare wheel.

### Interchanging the wheels

#### WARNING

Interchanging the front and rear wheels may severely impair the driving characteristics if the wheels or tires have different dimensions. The wheel brakes or suspension components may also be damaged. There is a risk of accident.

Rotate front and rear wheels only if the wheels and tires are of the same dimensions.

Always pay attention to the instructions and safety notes in the "Changing tires and mounting the spare wheel" section (▷ page 261).

The wear patterns on the front and rear tires differ, depending on the operating conditions. Rotate the wheels before a clear wear pattern has formed on the tires. Front tires typically wear more on the shoulders and the rear tires in the center.

If your vehicle's tire configuration allows, you can rotate the wheels according to the intervals in the tire manufacturer's warranty book in your vehicle documents. If this is not available, the tires should then be replaced every 3000 to 6000 miles (5000 to 10,000 km), or earlier if the tire wear requires this. Do not change the direction of wheel rotation.

Clean the contact surfaces of the wheel and the brake disc thoroughly every time a wheel is interchanged. Check the tire pressures.

For information on changing tires and mounting the spare wheel, see (▷ page 261).

 On vehicles equipped with a tire pressure monitor, electronic components are located in the wheel.

Tire-mounting tools should not be used near the valve. This could damage the electronic components.

Only have tires changed at a qualified specialist workshop.

### Direction of rotation

Tires with a specified direction of rotation have additional benefits, e.g. if there is a risk of hydroplaning. You will only gain these benefits if the correct direction of rotation is maintained.

An arrow on the sidewall of the tire indicates its correct direction of rotation.

You may mount a spare wheel/emergency spare wheel against the direction of rotation. Observe the time restriction on use as well as the speed limit specified on the spare wheel/emergency spare wheel.

### Storing wheels

Store wheels that are not being used in a cool, dry and preferably dark place. Protect the tires from oil, grease, gasoline and diesel.

### Cleaning the wheels

#### WARNING

Do not use power washers with circular-jet nozzles (dirt grinders) to clean your vehicle, in particular the tires. You could otherwise damage the tires and cause an accident.

## Wheel and tire combinations

### Please bear the following in mind

 For safety reasons, Mercedes-Benz recommends that you only use tires and wheels which have been approved by

Mercedes-Benz specifically for your vehicle.

These tires have been specially adapted for use with the control systems, such as ABS or ESP®, and are marked as follows:

- MO = Mercedes-Benz Original
- MOE = Mercedes-Benz Original Extended (tires featuring run-flat characteristics)
- MO1 = Mercedes-Benz Original (only certain AMG tires)

Mercedes-Benz Original Extended tires may only be used on wheels that have been specifically approved by Mercedes-Benz.

Only use tires, wheels or accessories tested and approved by Mercedes-Benz. Certain characteristics, e.g. handling, vehicle noise emissions or fuel consumption, may otherwise be adversely affected. In addition, when driving with a load, tire dimension variations could cause the tires to come into contact with the bodywork and axle components. This could result in damage to the tires or the vehicle.

Mercedes-Benz accepts no liability for damage resulting from the use of tires, wheels or accessories other than those tested and approved.

Information on tires, wheels and approved combinations can be obtained from any qualified specialist workshop.

- i** The recommended pressures for various operating conditions can be found:
  - on the Tire and Loading Information placard with the recommended tire pressures on the B-pillar on the driver's side
  - in the tire pressure table on the inside of the fuel filler flap

Observe the notes on recommended tire pressures under various operating conditions (> page 280).

Check tire pressures regularly, and only when the tires are cold. Comply with the maintenance recommendations of the tire

manufacturer in the vehicle document wallet.

- i** Notes on the vehicle equipment – always equip the vehicle with:
  - tires of the same size on a given axle (left/right)
  - the same type of tires at a given time (summer tires, winter tires, MOExtended tires)

- i** On the following pages, you can find information on approved wheel rims and tire sizes for equipping your vehicle with winter tires. Winter tires are not available at the factory as standard equipment or optional extras.

If you would like to equip your vehicle with approved winter tires, you may also, in certain circumstances, require rims of the appropriate size. The sizes of the approved winter tires may deviate from that of the standard tires. This is dependent on the model and the equipment installed at the factory.

The tires and wheel rims, as well as further information, can be obtained at a qualified specialist workshop.

- i** Overview of abbreviations used in the following tire tables:
  - BA: both axles
  - FA: front axle
  - RA: rear axle

In the following table, the wheel/tire combinations are assigned to the vehicle models through variants, e.g. V1, V2 etc.:

V1	C 250
V2	C 350, C 350 4MATIC
V3	C 63 AMG

- i** Not all wheel and tire combinations are available at the factory for all countries.

Tires					
	Summer tires	Alloy wheels	V1	V2	V3
BA	205/55 R16 91 W	7.0 J x 16 H2 Wheel offset: 1.69 in (43 mm)	•	–	–
BA	225/45 R17 91 W <sup>18</sup>	7.5 J x 17 H2 Wheel offset: 1.85 in (47 mm)	•	•	–
BA	225/45 R17 91 W MOExtended <sup>18, 19</sup>	7.5 J x 17 H2 Wheel offset: 1.85 in (47 mm)	•	•	–
FA	225/45 R17 91 W	7.5 J x 17 H2 Wheel offset: 1.85 in (47 mm)	•	•	–
RA	245/40 R17 91 W <sup>20</sup>	8.5 J x 17 H2 Wheel offset: 2.28 in (58 mm)			
FA	225/45 R17 91 W MOExtended	7.5 J x 17 H2 Wheel offset: 1.85 in (47 mm)	•	•	–
RA	245/40 R17 91 W MOExtended <sup>19, 20</sup>	8.5 J x 17 H2 Wheel offset: 2.28 in (58 mm)			
FA	225/40 R18 92 Y XL	8.0 J x 18 H2 Wheel offset: 1.97 in (50 mm)	•	•	–
RA	255/35 R18 94 Y XL <sup>20, 21</sup>	8.5 J x 18 H2 Wheel offset: 2.13 in (54 mm)			
FA	235/40 ZR18 95 Y XL	8.0 J x 18 H2 Wheel offset: 1.77 in (45 mm)	–	–	•
RA	255/35 ZR18 94 Y XL <sup>20</sup>	9.0 J x 18 H2 Wheel offset: 2.13 in (54 mm)			
FA	235/35 ZR19 XL	8.0 J x 19 H2 Wheel offset: 1.77 in (45 mm)	–	–	•
RA	255/30 ZR19 XL <sup>20</sup>	9.0 J x 19 H2 Wheel offset: 2.13 in (54 mm)			







<sup>18</sup> Not in conjunction with sports suspension code 486 or dynamic handling package code 483.

<sup>19</sup> MOExtended tires (tires featuring run-flat characteristics) only in combination with an activated tire pressure loss warning system or tire pressure monitor.

<sup>20</sup> Use of snow chains is not permitted. Observe the notes in the "Snow chains" section.

<sup>21</sup> Additional measures necessary (hub caps on rear axle, code 776).

	All-weather tires	Alloy wheels	V1	V2	V3
FA	225/45 R17 91 H M+S	7.5 J x 17 H2 Wheel offset: 1.85 in (47 mm)	•	–	–
RA	245/40 R17 91 H M+S <sup>20</sup>	8.5 J x 17 H2 Wheel offset: 2.28 in (58 mm)			
FA	225/40 R18 92 H XL M+S	8.0 J x 18 H2 Wheel offset: 1.97 in (50 mm)	•	•	–
RA	255/35 R18 94 H XL M+S <sup>20, 21</sup>	8.5 J x 18 H2 Wheel offset: 2.13 in (54 mm)			

	Winter tires	Alloy wheels	V1	V2	V3
BA	205/55 R16 91 H M+S 	7.0 J x 16 H2 Wheel offset: 1.69 in (43 mm)	•	–	–
BA	225/45 R17 91 H M+S 	7.5 J x 17 H2 Wheel offset: 1.85 in (47 mm)	•	•	–
BA	225/40 R18 92 V XL M+S 	8.0 J x 18 H2 Wheel offset: 1.77 in (45 mm)	–	–	•
BA	235/40 R18 95 V XL M+S  <sup>20</sup>	8.0 J x 18 H2 Wheel offset: 1.77 in (45 mm)	–	–	•
FA	235/40 R18 95 V XL M+S 	8.0 J x 18 H2 Wheel offset: 1.77 in (45 mm)	–	–	•
RA	255/35 R18 94 V XL M+S  <sup>20</sup>	9.0 J x 18 H2 Wheel offset: 2.13 in (54 mm)			

"Minispare" emergency spare wheel <sup>20</sup>					
Tires	Wheels	V1	V2	V3	
T 125/90 R16 98 M Tire pressure: 420 kPa (4.2 bar/61 psi)	3.5 B x 16 H2 Wheel offset: 0.79 in (20 mm)	•	–	–	
T 125/80 R17 99 M Tire pressure: 420 kPa (4.2 bar/61 psi)	3.5 B x 17 H2 Wheel offset: 0.79 in (20 mm)	–	•	–	
T 125/70 R18 99 M Tire pressure: 420 kPa (4.2 bar/61 psi)	3.5 B x 18 H2 Wheel offset: 0.79 in (20 mm)	–	–	•	

 The specified tire pressure is printed in yellow on the emergency spare wheel.

<sup>20</sup> Use of snow chains is not permitted. Observe the notes in the "Snow chains" section.

<sup>21</sup> Additional measures necessary (hub caps on rear axle, code 776).



Useful information .....	306
Notes on technical data .....	306
Genuine Mercedes-Benz parts .....	306
Warranty .....	307
Identification plates .....	307
Service products and filling capacities .....	308
Vehicle data .....	313



### Useful information

- i** This Operator's Manual describes all models and all standard and optional equipment of your vehicle available at the time of publication of the Operator's Manual. Country-specific differences are possible. Please note that your vehicle may not be equipped with all features described. This also applies to safety-related systems and functions.
- i** Please read the information on qualified specialist workshops (▷ page 23).

### Notes on technical data

- i** The data stated here specifically refers to a vehicle with standard equipment. Consult a Mercedes-Benz Center for the data for all vehicle variants and trim levels.

## Technical data

### Genuine Mercedes-Benz parts

All Mercedes-Benz Centers maintain a supply of genuine Mercedes-Benz parts for necessary service and repair work. In addition, strategically located parts delivery centers provide for quick and reliable parts service.

There are more than 300,000 different genuine Mercedes-Benz parts available for Mercedes-Benz models.

Genuine Mercedes-Benz parts are subject to strict quality control. Each part has been specially developed, manufactured or selected for Mercedes-Benz vehicles and fine-tuned for them.

Therefore, only genuine Mercedes-Benz parts should be used.

#### **WARNING**

Driving safety may be impaired if non-approved parts, tires and wheels or safety-relevant accessories are used.

This could lead to malfunctions in safety-relevant systems, e.g. the brake system. This could cause you to lose control of your vehicle and cause an accident.

For this reason, Mercedes-Benz recommends that you use genuine Mercedes-Benz parts or parts of equal quality. Only use tires, wheels and accessories that have been specifically approved for your vehicle.

- !** Air bags and Emergency Tensioning Devices, as well as control units and sensors for these restraint systems may be installed in the following areas of your vehicle:

- doors
- door pillars
- door sills
- seats
- dashboard
- instrument cluster
- center console

Do not install accessories such as audio systems in these areas. Do not carry out repairs or welding. You could impair the operating efficiency of the restraint systems.

Have aftermarket accessories installed at a qualified specialist workshop. Mercedes-Benz recommends that you use an authorized Mercedes-Benz Center for this purpose.

#### **Environmental note**

Daimler AG also supplies reconditioned major assemblies and parts which are of the same quality as new parts. They are covered by the same Limited Warranty entitlements as new parts.

Always specify the vehicle identification number (VIN) (▷ page 307) and the engine number (▷ page 308) when ordering genuine Mercedes-Benz parts.

Warranty

The Service and Warranty Information booklet contains detailed information about the warranties covering your vehicle.

Your authorized Mercedes-Benz Center will exchange or repair any defective parts originally installed in the vehicle in accordance with the terms of the following warranties:

- New Vehicle Limited Warranty
- Emission System Warranty
- Emission Performance Warranty
- California, Connecticut, Maine, Massachusetts, New York, Pennsylvania, Rhode Island and Vermont Emission Control Systems Warranty
- State Warranty Enforcement Laws (Lemon Laws)

Replacement parts and accessories are covered by the Mercedes-Benz Parts and Accessories warranties. You can obtain information about this from any authorized Mercedes-Benz Center.

**i** Should you lose your Service and Warranty Information booklet, have an authorized Mercedes-Benz Center arrange for a replacement. It will be mailed to you.

Identification plates

Vehicle identification plate with vehicle identification number (VIN) and paint code number

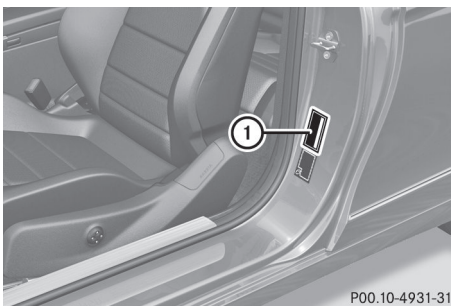

P00.10-4931-31

- ▶ Open the driver's door.  
You will see vehicle identification plate ①.

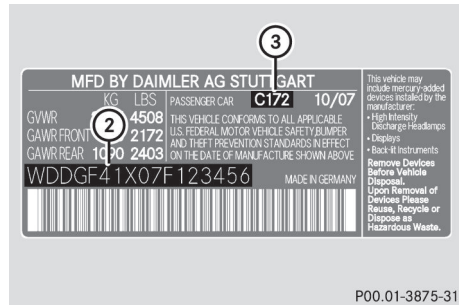

P00.01-3875-31

Example: vehicle identification plate (USA only)

- ② VIN
- ③ Paint code

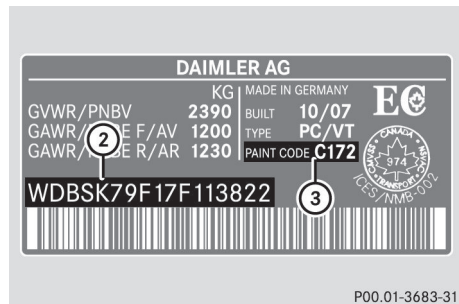

P00.01-3683-31

Example: vehicle identification plate (Canada only)

- ② VIN
- ③ Paint code

**i** The data shown on the identification plate is example data. This data is different for every vehicle and can deviate from the data shown here. You can find the data applicable to your vehicle on the vehicle's identification plate.

Vehicle identification number (VIN)

The vehicle identification number (VIN) can be found in the following locations:

- on the vehicle identification plate (▷ page 307)
- on the lower edge of the windshield (▷ page 308)

In addition to being stamped on the vehicle identification plate, the vehicle identification number (VIN) is also stamped onto the vehicle body.

It is located on the floor in front of the right-hand front seat.

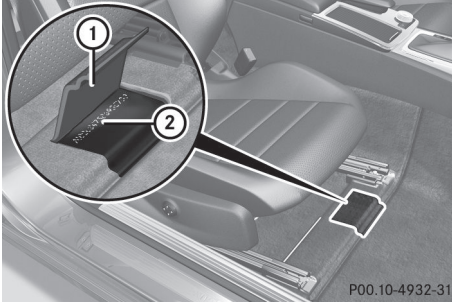

- ▶ Slide the right-hand front seat to its rearmost position.
- ▶ Fold floor covering ① upwards. You will see vehicle identification number (VIN) ②.

### Engine number

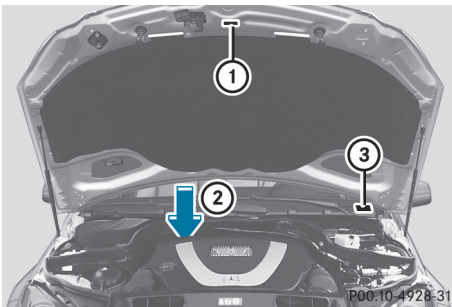

- ① Emission control information plate, including the certification of both federal and Californian emissions standards
- ② Engine number (stamped into the crankcase)
- ③ VIN (on the lower edge of the windshield)

## Service products and filling capacities

### Important safety notes

#### ⚠ WARNING

Comply with all valid regulations with respect to handling, storing and disposing of service fluids. Otherwise, you could endanger persons or the environment.

Keep service fluids out of the reach of children.

For health reasons, you should prevent service fluids from coming into direct contact with your skin or clothing.

If a service fluid is swallowed, contact a physician immediately.

#### ♻ Environmental note

Dispose of service products in an environmentally responsible manner.

Service products include the following:

- fuels (e.g. gasoline, diesel)
- lubricants (e.g. engine oil, transmission oil)
- coolant
- brake fluid
- windshield washer fluid
- climate control system refrigerant

Components and service products must be matched. You should therefore only use products that have been tested and approved by Mercedes-Benz.

Information on tested and approved products can be obtained at an authorized Mercedes-Benz Center or on the Internet at <http://bevo.mercedes-benz.com>.

You can recognize service products approved by Mercedes-Benz by the following inscription on the containers:

- MB approval (e.g. MB approval 229.51)
- MB Approval (e.g. MB Approval 229.51)

Other designations or recommendations indicate a level of quality or a specification in accordance with an MB Sheet number (e.g.

MB 229.5). They have not necessarily been approved by Mercedes-Benz.

**Fuel**

**Important safety notes**

**⚠ WARNING**

Gasoline is highly flammable and poisonous. It burns violently and can cause serious personal injury.

Never allow sparks, flames or smoking materials near gasoline.

Turn off the engine before refueling.

Whenever you are around gasoline, avoid inhaling fumes and any skin or clothing contact.

Direct skin contact with fuels and the inhalation of fuel vapors are damaging to your health.

**Tank capacity**

Technical data for the C 350 4MATIC model was not available at the time of going to print.

<b>Total capacity</b>	
<b>All models</b>	17.4 US gal (66.0 l)

<b>Of which reserve</b>	
<b>All models (except C 63 AMG)</b>	Approx. 2.1 US gal (8.0 l)
<b>C 63 AMG</b>	Approx. 3.7 US gal (14.0 l)

**Gasoline**

**Fuel grade**

**!** Do not use diesel to refuel vehicles with a gasoline engine. Even small amounts of the

wrong fuel result in damage to the fuel system and engine.

**!** You should only refuel with unleaded premium-grade gasoline as this avoids damaging the catalytic converter.

If engine running problems are apparent, have the cause checked immediately and repaired. Excess unburned fuel can otherwise enter the catalytic converter, leading to overheating and possibly causing a fire.

**!** To ensure the longevity and full performance of the engine, only premium-grade unleaded gasoline may be used. If there is no premium-grade unleaded gasoline available and regular unleaded gasoline must be used, please observe the following precautions:

- only fill the fuel tank to half full with regular unleaded gasoline and fill the rest with premium-grade unleaded gasoline as soon as possible.
- do not drive at the maximum speed.
- avoid sudden acceleration.
- if the vehicle is carrying a light load, e.g. two passengers without luggage, do not allow the engine to rev above 3000 rpm.
- if the vehicle is fully loaded or is being operated in mountainous terrain, do not depress the accelerator pedal further than  $\frac{2}{3}$  of the pedal travel.

Only refuel with premium-grade unleaded gasoline with a minimum octane number of 91.

Reformulated Gasoline (RFG) and/or unleaded gasoline with additives can be used. However, the concentration of additives in the fuel must be less than 10%, e.g.

- Ethanol
- TAME
- ETBE
- IPA
- TBA

For MTBE, the concentration should not exceed 15%.

The concentration of methanol in gasoline including other additives must not exceed 3%.

Using mixtures of methanol and ethanol is not permitted. Gasohol, a mixture of 10% ethanol and 90% unleaded gasoline, can be used.

All of these mix fuels must fulfill the fuel requirements, e.g.:

- knock resistance
- boiling point
- vapor pressure

You will usually find information about the fuel grade on the pump. If you cannot find the label on the pump, ask the staff for assistance.

**i** For further information, consult an authorized Mercedes-Benz Center or visit <http://www.mbusa.com> (USA only).

Information on refueling (▷ page 137).

### Additives

**!** Do not refuel with low-grade fuel and do not use fuel additives that are not tested and approved for Mercedes-Benz vehicles. Damage to or malfunctions of the fuel system may otherwise occur.

One of the main problems of poor fuel quality is the forming of deposits that are created during the gasoline combustion process. Mercedes-Benz recommends that you use branded fuels that have additives.

If you use fuels without these additives over a longer period of time, carbon deposits may build up. These deposits form at the inlet valves and in the combustion chamber in particular.

This could lead to engine problems, e.g.:

- longer engine warm-up phase
- uneven idle
- engine noise
- misfiring
- loss of power

Carbon deposits may form if the availability of gasoline with relevant additives is insufficient (in certain regions). In this case, Mercedes-Benz recommends additives approved for use in Mercedes-Benz vehicles; see <http://bevo.mercedes-benz.com>.

For a list of approved products, consult an authorized Mercedes-Benz Center. Comply with the instructions for use on the product label.

Do not mix other fuel additives with fuel. This causes unnecessary costs and could damage the engine.

## Engine oil

### Please bear the following in mind

**!** Never use engine oil or an oil filter of a specification other than is necessary to fulfill the prescribed service intervals. Do not change the engine oil or oil filter in order to achieve longer replacement intervals than those prescribed. You could otherwise cause engine damage or damage to the exhaust gas aftertreatment.

Follow the instructions in the service interval display regarding the oil change. Otherwise, you may damage the engine and the exhaust gas aftertreatment.

The engine oils are matched to the performance of Mercedes-Benz engines and service intervals. You should therefore only use engine oils and oil filters that are approved for vehicles with maintenance systems.

For a list of approved engine oils and oil filters, consult an authorized Mercedes-Benz Center. Or visit the website <http://bevo.mercedes-benz.com>.

The table shows which engine oils have been approved for your vehicle.

Model	Engine model	MB Approval
C 250	271	229.5
C 350 C 350 4MATIC	276	
C 63 AMG	156	229.5 <sup>22</sup>

**i** MB approval is indicated on the oil containers.

### Filling capacities

The following values refer to an oil change including the oil filter.

Model	Capacity
C 250	5.8 US qt (5.5 l)
C 350 C 350 4MATIC	6.9 US qt (6.5 l)
C 63 AMG	9.0 US qt (8.5 l) <sup>23</sup>

### Additives

**!** Do not use any additives in the engine oil. This could damage the engine.

### Engine oil viscosity

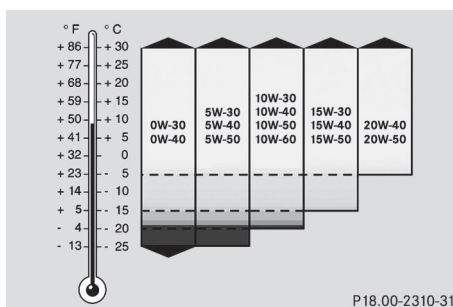

Viscosity describes the flow characteristics of a fluid. If an engine oil has a high viscosity,

this means that it is thick; a low viscosity means that it is thin.

Select an engine oil with an SAE (viscosity) classification suitable for the prevailing outside temperatures. The table shows you which SAE classifications are to be used. The low-temperature characteristics of engine oils can deteriorate significantly, e.g. as a result of aging, soot and fuel deposits. It is therefore strongly recommended that you carry out regular oil changes using an approved engine oil with the appropriate SAE classification.

### Brake fluid

#### **⚠** WARNING

Over a period of time, the brake fluid absorbs moisture from the air; this lowers its boiling point.

If the boiling point of the brake fluid is too low, vapor pockets may form in the brake system when the brakes are applied hard (e.g. when driving downhill). This would impair braking efficiency.

You should have the brake fluid renewed at regular intervals. The brake fluid change intervals can be found in the Maintenance Booklet.

Only use brake fluid approved by Mercedes-Benz. Information about approved brake fluid can be obtained at any qualified specialist workshop or on the Internet at <http://bevo.mercedes-benz.com>.

<sup>22</sup> Only SAE 0W-40/SAE 5W-40 engine oils may be used.

<sup>23</sup> Including external oil cooler.

## Coolant

### Important safety notes

#### WARNING

Antifreeze is highly flammable. Fire, naked flames and smoking are prohibited when handling antifreeze.

If antifreeze comes into contact with hot engine parts, it may ignite and you could burn yourself. Do not spill any antifreeze on hot engine parts.

**!** Only add coolant that has been premixed with the desired antifreeze protection. You could otherwise damage the engine.

Further information on coolants can be found in the Mercedes-Benz Specifications for Service Products, MB Specifications for Service Products 310.1, e.g. on the Internet at <http://bevo.mercedes-benz.com>. Or contact a qualified specialist workshop.

**!** Always use a suitable coolant mixture, even in countries where high temperatures prevail.

Otherwise, the engine cooling system is not sufficiently protected from corrosion and overheating.

The coolant is a mixture of water and antifreeze/corrosion inhibitor. It performs the following tasks:

- corrosion protection
- antifreeze protection
- raising the boiling point

If the coolant has antifreeze protection down to -35 °F (-37 °C), the boiling point of the coolant under operating conditions is approximately 266 °F (130 °C).

The antifreeze/corrosion inhibitor concentration in the engine cooling system should:

- be at least 50 %. This will protect the engine cooling system against freezing down to approximately -35 °F (-37 °C).
- not exceed 55% (antifreeze protection down to -49 °F [-45 °C]). Otherwise, heat will not be dissipated as effectively.

If the vehicle has lost coolant, add equal amounts of water and antifreeze/corrosion inhibitor. Mercedes-Benz recommends an antifreeze/corrosion inhibitor concentrate in accordance with MB Specifications for Service Products 310.1.

The coolant is checked with every maintenance interval at a qualified specialist workshop.

**i** When the vehicle is first delivered, it is filled with a coolant mixture that ensures adequate antifreeze and corrosion protection.

### Capacity

Model	Capacity
<b>C 250</b>	Approx. 8.1 US qt (7.7 l)
<b>C 350</b> <b>C 350 4MATIC</b>	Approx. 8.6 US qt (8.1 l)
<b>C 63 AMG</b>	Approx. 12.4 US qt (11.7 l)

**i** Use MB 325.0 or MB 326.0 corrosion inhibitor/antifreeze.

### Washer fluid

#### WARNING

Washer solvent/antifreeze is highly flammable. Do not spill washer solvent/antifreeze on hot engine parts, because it may



ignite and burn. You could be seriously burned.

**!** Only use washer fluid that is suitable for plastic lamp lenses, e.g. MB SummerFit or MB WinterFit. Unsuitable washer fluid could damage the plastic lenses of the headlamps.

**!** Do not add distilled or de-ionized water to the washer fluid container. Otherwise, the level sensor may be damaged.

**!** Only MB SummerFit and MB WinterFit washer fluid should be mixed together. The spray nozzles may otherwise become blocked.

At temperatures above freezing:

- ▶ Fill the washer fluid reservoir with a mixture of water and windshield washer fluid, e.g. MB SummerFit.
- ▶ Add 1 part MB SummerFit to 100 parts water.

At temperatures below freezing:

- ▶ Fill the washer fluid reservoir with a mixture of water and windshield washer fluid, e.g. MB WinterFit. Adapt the mixing ratio to the outside temperature.
- ▶ Down to 14 °F (-10 °C): mix 1 part MB WinterFit with 2 parts water.
- ▶ Down to -4 °F (-20 °C): mix 1 part MB WinterFit with 1 part water.
- ▶ Down to -20.2 °F (-29 °C): mix 2 parts MB WinterFit with 1 part water.

Technical data for the C 350 4MATIC model was not available at the time of going to print.

Model	Capacity
All models	3.7 US qt (3.5 l)

- i** Add windshield washer fluid, e.g. MB SummerFit or MB WinterFit, to the washer fluid all year round.

## Vehicle data

Please note that for the specified vehicle data:

- the heights specified may vary as a result of:
  - tires
  - load
  - condition of the suspension
  - optional equipment
- The vehicle length specified includes the front license plate adapter.

Missing values were not available at time of going to print.

### All models (except AMG vehicles)

Vehicle length	182.9 in (4646 mm)
Vehicle width including exterior mirrors	78.6 in (1997 mm)
Vehicle height	55.4 in (1406 mm)
Wheelbase	108.7 in (2760 mm)
Turning radius	36.1 ft (11.01 m)
Maximum roof load	220 lb (100 kg)
Maximum trunk load	220 lb (100 kg)

### C 63 AMG

Vehicle length	185.5 in (4712 mm)
Vehicle width including exterior mirrors	78.6 in (1997 mm)
Vehicle height	54.8 in (1391 mm)
Wheelbase	108.9 in (2765 mm)
Turning radius	36.4 ft (11.10 m)



**C 63 AMG****Maximum roof load****Maximum trunk  
load**

220 lb (100 kg)





## **Publication details**

### **Internet**

Further information about Mercedes-Benz vehicles and about Daimler AG can be found on the following websites:

<http://www.mbusa.com> (USA only)

<http://www.mercedes-benz.ca> (Canada only)

### **Editorial office**

Not to be reprinted, translated or otherwise reproduced, in whole or in part, without the written permission of Daimler AG.



2045848082

Order no. 6515 0762 13 Part no. 204 584 80 82 Edition B 2012