



SLS AMG

Coupe and Coupe GT, Roadster and Roadster GT
Operator's Manual



Mercedes-Benz

Symbols

Registered trademarks:

- Bluetooth® is a registered trademark of Bluetooth SIG Inc.
- DTS is a registered trademark of DTS, Inc.
- Dolby and MLP are registered trademarks of DOLBY Laboratories.
- BabySmart™, ESP® and PRE-SAFE® are registered trademarks of Daimler AG.
- HomeLink® is a registered trademark of Prince.
- iPod® and iTunes® are registered trademarks of Apple Inc.
- Logic7® is a registered trademark of Harman International Industries.
- Microsoft® and Windows media® are registered trademarks of Microsoft Corporation.
- SIRIUS is a registered trademark of Sirius XM radio Inc.
- HD Radio is a registered trademark of iBiquity Digital Corporation.
- Gracenote® is a registered trademark of Gracenote, Inc.
- ZAGATSurvey® and related brands are registered trademarks of ZagatSurvey, LLC.

In this Operator's Manual, you will find the following symbols:

WARNING

Warning notes draw your attention to hazards that endanger your health or life, or the health or life of others.

Environmental note

Environmental notes provide you with information on environmentally aware actions or disposal.

 Notes on material damage alert you to dangers that could lead to damage to your vehicle.

 Practical tips or further information that could be helpful to you.

 This symbol indicates an instruction that must be followed.

 Several of these symbols in succession indicate an instruction with several steps.

 (▷ page) This symbol tells you where you can find more information about a topic.

 This symbol indicates a warning or an instruction that is continued on the next page.

Display This font indicates a display in the multifunction display/COMAND display.

Parts of the software in the vehicle are protected by copyright © 2005 The FreeType Project <http://www.freetype.org>. All rights reserved.

Publication details

Internet

Further information about Mercedes-Benz vehicles and about Daimler AG can be found on the following websites

<http://www.mbusa.com> (USA only)

<http://www.mercedes-benz.ca> (Canada only)

Editorial office

You are welcome to forward any queries or suggestions you may have regarding this Operator's Manual to the technical documentation team at the following address:

Daimler AG, HPC: CAC, Customer Service,
70546 Stuttgart, Germany

©Daimler AG: Not to be reprinted, translated or otherwise reproduced, in whole or in part, without written permission of Daimler AG.

Welcome to the world of Mercedes-Benz

We urge you to read this Operator's Manual carefully and familiarize yourself with the vehicle before driving. For your own safety and a longer vehicle life, follow the instructions and warning notices in this manual. Ignoring them could result in damage to the vehicle or personal injury to you or others.

Vehicle damage caused by failure to follow instructions is not covered by the Mercedes-Benz Limited Warranty.

The equipment or product designation of your vehicle may vary depending on:

- Model
- Order
- Country specification
- Availability

Mercedes-Benz therefore reserves the right to introduce changes in the following areas:

- design
- equipment
- technical features

The equipment in your vehicle may therefore differ from that shown in the descriptions and illustrations.

The following are integral components of the vehicle:

- Operator's Manual
- Maintenance Booklet
- Equipment-dependent supplements

Keep printed copies of the documents in the vehicle at all times. If you sell the vehicle, always pass the documents on to the new owner.

The technical documentation team at Daimler AG wishes you safe and pleasant motoring.

Mercedes-Benz USA, LLC

Mercedes-Benz Canada, Inc.

A Daimler Company

<hr/>		<hr/>		<hr/>
Index	4	At a glance	25	
<hr/>		<hr/>		
Introduction	18	Safety	35	
		<hr/>		
		Opening and closing	61	
		<hr/>		
		Seats, steering wheel and mirrors	81	
		<hr/>		
		Lights and windshield wipers	91	
		<hr/>		
		Climate control	101	
		<hr/>		
		Driving and parking	111	
		<hr/>		
		On-board computer and displays	145	
		<hr/>		
		Stowage and features	195	
		<hr/>		
		Maintenance and care	213	
		<hr/>		
		Breakdown assistance	227	
		<hr/>		
		Wheels and tires	247	
		<hr/>		
		Technical data	273	

1, 2, 3 ...

12 V socket
see Sockets

A

ABS (Anti-lock Braking System)

Function/notes 55
Warning lamp 189

Activating/deactivating cooling with air dehumidification 104

ADAPTIVE BRAKE 58

Additional speedometer 154

Additives (engine oil) 280

Adjusting lumbar support 84

Air bags

Display message 167
Front air bag (driver, front passenger) 39
Head bag 41
Important safety notes 38
Knee bag 40
PASSENGER AIR BAG OFF indicator lamp 42
Safety guidelines 37
Side impact air bag 40

Air-conditioning system

see Climate control

Air filter (display message) 176

AIRSCARF

Setting the vents 109
Switching on/off 85

Air vents

Important safety notes 108
Setting 108
Setting the AIRSCARF vents 109
Setting the center air vents 108
Setting the side air vents 108
Switching AIRSCARF on/off 85
see Climate control

Alarm system

see ATA (Anti-Theft Alarm system)

AMG

Adaptive sport suspension system 136
Button for AMG menu 124
E-SELECT lever 117

Menu (on-board computer) 157
SETUP 124
SPEEDSHIFT DCT 7-gear sport transmission 117

Anti-lock braking system

see ABS (Anti-lock Braking System)

Anti-theft alarm system

see ATA (Anti-Theft Alarm system)

Ashtray 199

ASSYST PLUS service interval display

Hiding service messages 218
Service messages 217

ATA (Anti-Theft Alarm system)

Activating/deactivating 58
Function 58
Switching off the alarm 58

Audio menu (on-board computer) 151

Audio system

see separate operating instructions

Authorized Centers

see Qualified specialist workshop

Authorized Mercedes-Benz Center

see Qualified specialist workshop

Authorized workshops

see Qualified specialist workshop

AUTO lights

Display message 170

Automatic headlamp mode 92

B

Backup lamp

Display message 171

BAS (Brake Assist System) 55

Battery

Display message 181

Battery (SmartKey)

Checking 64
Important safety notes 63
Replacing 64

Battery (vehicle)

Charging 238
Display message 174
Important safety notes 236
Jump starting 240

- Blind Spot Assist**
 Activating/deactivating 153
 Display message 177
 Notes/function 141
- Brake Assist**
 see BAS (Brake Assist System)
- Brake fluid**
 Display message 165
 Notes 280
- Brake lamps**
 Display message 170
- Brakes**
 ABS 55
 BAS 55
 Brake fluid (notes) 280
 Display message 161
 Driving tips 131
 High-performance brake system 133
 Important safety notes 131
 Maintenance 132
 Warning lamp 186, 189
- Breakdown**
 see Flat tire
 see Towing away/tow-starting
- Bulbs**
 see Changing bulbs
- C**
- California**
 Important notice for retail
 customers and lessees 19
- Calling up a malfunction**
 see Display messages
- Capacities**
 see Technical data
- Car**
 see Vehicle
- Care**
 Car wash 219
 Display 225
 Exhaust pipe 224
 Exterior lights 224
 Gear or selector lever 225
 Matte finish 222
 Notes 219
 Paint 221
 Plastic trim 225
 Power washer 221
 Rear view camera 224
 Seat belt 226
 Seat cover 226
 Sensors 224
 Soft top 222
 Steering wheel 225
 Trim pieces 225
 Washing by hand 220
 Wheels 221
 Windows 223
 Wiper blades 223
 Wooden trim 225
- Car wash (care)** 219
- CD player/CD changer (on-board computer)** 151
- Center console**
 Lower section 31
 Upper section 30
- Central locking**
 Automatic locking (on-board
 computer) 155
 Locking/unlocking (SmartKey) 62
- Changing bulbs**
 Important safety notes 96
 License plate lighting 97
- Charge maintenance socket** 211
- Children**
 In the vehicle 51
 Restraint systems 51
- Child seat**
 Special seat belt retractor 53
 Top Tether 53
- Cigarette lighter** 199
- Climate control**
 Automatic climate control (dual-
 zone) 103
 Controlling automatically 105
 Cooling with air dehumidification . . 104
 Defrosting the windows 107
 Defrosting the windshield 106
 Important safety notes 102
 Indicator lamp 105
 Maximum cooling 106
 Notes on using automatic climate
 control 104
 Overview of systems 102

- Problems with cooling with air dehumidification 105
 - Problem with the rear window defroster 107
 - Refrigerant 280
 - Setting the air distribution 105
 - Setting the airflow 106
 - Setting the air vents 108
 - Setting the temperature 105
 - Switching air-recirculation mode on/off 107
 - Switching on/off 104
 - Switching the MONO function on/off 106
 - Switching the rear window defroster on/off 107
 - Cockpit**
 - Overview 26
 - see Instrument cluster
 - COMAND**
 - see separate operating instructions
 - Combination switch** 94
 - Consumption statistics (on-board computer)** 148
 - Convenience closing feature** 75
 - Convenience opening feature** 75
 - see Opening/closing the side windows (all)
 - Coolant**
 - Display message 173
 - Coolant (engine)**
 - Checking the level 216
 - Important safety notes 280
 - Temperature (on-board computer) . 157
 - Cooling**
 - see Climate control
 - Crash-responsive emergency lighting** 96
 - Cruise control**
 - Cruise control lever 135
 - Deactivating 136
 - Display message 176
 - Driving system 134
 - Function/notes 134
 - Important safety notes 134
 - LIM indicator lamp 135
 - Setting a speed 135
 - Storing and maintaining current speed 135
 - Cup holder**
 - Center console 198
 - Important safety notes 198
 - Cup holders**
 - see Cup holder
 - Curb weight**
 - see Technical data
 - Customer Assistance Center (CAC) ...** 22
 - Customer Relations Department** 22
- D**
- Dashboard**
 - see Cockpit
 - see Instrument cluster
 - Data**
 - see Technical data
 - Daytime running lamps**
 - Display message 171
 - Switching on/off (on-board computer) 154
 - Switching on/off (switch) 92
 - Dealerships**
 - see Qualified specialist workshop
 - Declarations of conformity** 21
 - Delayed switch-off**
 - Exterior lighting (on-board computer) 155
 - Interior lighting 155
 - Diagnostics connection** 21
 - Digital speedometer** 149
 - Display (cleaning instructions)** 225
 - Display messages**
 - ASSYST PLUS service interval display 217
 - Calling up (on-board computer) 160
 - Driving systems 176
 - Engine 172
 - Hiding (on-board computer) 160
 - Lights 169
 - Safety systems 166
 - Service interval display 217
 - SmartKey 181
 - Tires 177
 - Vehicle 180

- Distance recorder** 148
 - see Trip odometer
 - Door control panel**
 - Overview 33
 - Doors**
 - Automatic locking (on-board computer) 155
 - Automatic locking (switch) 69
 - Central locking/unlocking (SmartKey) 62
 - Display message 180, 182
 - Emergency locking 70
 - Emergency unlocking 69
 - Important safety notes 67
 - Opening (from inside) 68
 - Draft stop** 78
 - Drinking and driving** 131
 - Drive program** 120
 - Automatic 122
 - Manual 123
 - SETUP (on-board computer) 157
 - Drive program display** 119
 - Driver's door**
 - see Doors
 - Driving abroad**
 - Mercedes-Benz Service 219
 - Symmetrical low beam 92
 - Driving lamps**
 - see Daytime running lamps
 - Driving on flooded roads** 133
 - Driving safety systems**
 - ABS (Anti-lock Braking System) 55
 - ADAPTIVE BRAKE 58
 - BAS (Brake Assist System) 55
 - EBD (electronic brake force distribution) 58
 - ESP® (Electronic Stability Program) 56
 - ETS (Electronic Traction System) 56
 - Important safety information 54
 - Overview 54
 - Driving systems**
 - AMG adaptive sport suspension system 136
 - Blind Spot Assist 141
 - Cruise control 134
 - Display message 176
 - PARKTRONIC 137
 - Rear view camera 140
 - Driving tips**
 - AMG ceramic high-performance compound brake system 133
 - Brakes 131
 - Break-in period 112
 - Downhill gradient 131
 - Drinking and driving 131
 - Driving abroad 92
 - Driving in winter 133
 - Driving on wet roads 133
 - Exhaust check 131
 - Fuel 130
 - General 130
 - Hydroplaning 133
 - Icy road surfaces 134
 - Limited braking efficiency on salted roads 132
 - Snow chains 250
 - Symmetrical low beam 92
 - Wet road surface 132
 - DVD audio (on-board computer)** 151
 - DVD video (on-board computer)** 151
- ## E
- EASY-ENTRY feature**
 - Activating/deactivating 156
 - Function/notes 86
 - EASY-EXIT feature**
 - Crash-responsive 87
 - Function/notes 86
 - Switching on/off 156
 - EBD (electronic brake force distribution)**
 - Display message 162
 - Function/notes 58
 - Electronic Stability Program**
 - see ESP® (Electronic Stability Program)
 - Electronic Traction System**
 - see ETS
 - Emergency release**
 - Driver's door 69
 - Trunk 73
 - Vehicle 69

Emergency Tensioning Devices

- Function 50
- Safety guidelines 37

Emissions control

- Service and warranty information 19

Engine

- Display message 172
- Engine number 276
- Irregular running 116
- Starting 114
- Starting problems 116
- Starting the engine with the SmartKey 114
- Starting with the KEYLESS-GO start function 114
- Switching off 128

Engine diagnostics warning lamp 191**Engine electronics**

- Problem (malfunction) 116

Engine oil

- Adding 216
- Additives 280
- Checking the oil level 215
- Checking the oil level using the dipstick 215
- Display message 174, 175
- Filling capacity 277, 280
- Notes about oil grades 279
- Notes on oil level/consumption 215
- Temperature (on-board computer) . 157
- Temperature gauge 146
- Viscosity 280

E-SELECT lever 117**ESP® (Electronic Stability Program)**

- Deactivating/activating 56
- Display message 166
- Function/notes 56
- Important safety information 56
- Warning lamp 190

ETS (Electronic Traction System) 56**Exhaust check 131****Exhaust pipe (cleaning instructions) 224****Exterior lighting**

- Setting options 92
- see Lights

Exterior mirrors

- Adjusting 87
- Dipping (automatic) 88
- Folding in/out (automatically) 88
- Folding in/out (electrically) 88
- Folding in when locking (on-board computer) 156
- Out of position (troubleshooting) 88
- Setting 88
- Storing settings (memory function) 89
- Storing the parking position 89

F**Filler cap**

- see Fuel filler flap

First-aid kit 228**Flat tire**

- Changing a wheel/mounting the spare wheel 232
- Preparing the vehicle 229
- Raising the vehicle 233
- TIREFIT kit 229

Floormat 212**Fuel**

- Additives 279
- Consumption statistics 148
- Displaying the range 149
- Driving tips 130
- Fuel gauge 27
- Grade (gasoline) 278
- Important safety notes 277
- Problem (malfunction) 127
- Refueling 124
- Tank content/reserve fuel 277, 278

Fuel filler flap, opening/closing 125**Fuel filter (display message) 176****Fuel level**

- Calling up the range (on-board computer) 149

Fuel tank

- Capacity 277, 278
- Problem (malfunction) 127
- see Fuel tank

- Fuse box**
 Front-passenger footwell 245
 Rear compartment 245
- Fuses**
 Allocation chart 245
 Before changing 245
 Important safety notes 244
 see Fuses
- G**
- Garage door opener**
 Clearing the memory 211
 Notes 208
 Opening/closing the garage door .. 211
 Programming (button in the rear-view mirror) 209
- Gasoline** 278
- Gear indicator** 119
- Gear or selector lever (cleaning guidelines)** 225
- Genuine Mercedes-Benz parts** 274
- Glove box** 196
- H**
- Hazard warning lamps** 94
- Head bags** 41
- Headlamp cleaning system**
 Notes 281
- Headlamps**
 Adding fluid to cleaning system 217
 Cleaning system (capacity) 282
 Cleaning system (function) 95
 Cleaning system (notes) 281
 Fogging up 95
 see Automatic headlamp mode
- Head level heating (AIRSCARF)** 85
- Heating**
 see Climate control
- High-beam headlamps**
 Display message 171
 Switching on/off 94
- Hill start assist** 115
- Hood**
 Closing 215
 Display message 180
- Important safety notes 214
 Opening 214
- Hydroplaning** 133
- I**
- Ignition lock** 113
- Immobilizer** 58
- Indicator lamps**
 see Warning and indicator lamps
- Instrument cluster**
 Overview 27
 Settings 153
 Warning and indicator lamps 28
- Instrument cluster lighting** 154
- Interior lighting**
 Automatic control 95
 Delayed switch-off (on-board computer) 155
 Emergency lighting 96
 Manual control 96
 Overview 95
 Reading lamp 95
- J**
- Jack**
 Storage location 228
 Using 233
- Jump-start (engine)**
 see Jump starting (engine)
- Jump starting (engine)** 240
- K**
- KEYLESS-GO start function**
 Display message 181
 Start/Stop button 113
 Starting the engine 114
- Key positions**
 SmartKey 113
- Kickdown** 120
 Driving tips 120
- Knee bag** 40

L

Lamps

see Warning and indicator lamps

Lap time (RACETIMER) 157

License plate lamp

Changing bulbs 97

Display message 171

Lights

Activating/deactivating the interior lighting delayed switch-off . 155

Automatic headlamp mode 92

Display message 169

Driving abroad 92

Hazard warning lamps 94

High beam flasher 94

High-beam headlamps 94

Light switch 92

Low-beam headlamps 93

Parking lamps 93

Standing lamps 94

Switching the daytime running lamps on/off (on-board computer) 154

Switching the daytime running lamps on/off (switch) 92

Switching the exterior lighting delayed switch-off on/off (on-board computer) 155

Switching the surround lighting on/off (on-board computer) 155

Turn signals 94

see Changing bulbs

see Lights

LIM indicator lamp

Cruise control 135

Locking

see Central locking

Locking (doors)

Automatic 69

Emergency locking 70

From inside (central locking button) 68

Locking centrally

see Central locking

Locking verification signal (on-board computer) 156

Low-beam headlamps

Display message 170

Setting for driving abroad (symmetrical) 92

Switching on/off 93

M

M+S tires 251

Malfunction message

see Display messages

Manual drive program 123

Matte finish (cleaning instructions) 222

mbrace

Call priority 205

Display message 169

Downloading destinations (COMAND) 205

Emergency call 202

Important safety notes 201

Locating a stolen vehicle 206

MB info call button 204

Remote vehicle locking 205

Roadside Assistance button 203

Search & Send 205

Self-test 201

System 201

Mechanical key

Function/notes 63

Locking vehicle 70

Unlocking the driver's door 69

Memory card (audio) 151

Memory function 89

Message memory (on-board computer) 160

Messages

see Display messages

Mirrors

see Exterior mirrors

see Rear-view mirror

see Vanity mirror

Mobile phone

Menu (on-board computer) 152

Modifying the programming (SmartKey) 63

- MP3**
 Operation 151
 see separate operating instructions
- Multifunction display**
 Function/notes 147
 Permanent display 154
- Multifunction steering wheel**
 Operating the on-board computer . 147
 Overview 29
- N**
- Navigation**
 Menu (on-board computer) 149
 On-board computer 149
 see separate operating instructions
- Notes on breaking-in a new vehicle** 112
- O**
- Occupant Classification System (OCS)**
 Faults 46
 Operation 42
 System self-test 45
- Occupant safety**
 Children in the vehicle 51
 System overview 36
- OCS**
 Faults 46
 Operation 42
 System self-test 45
- Odometer** 148
 see Trip odometer
- On-board computer**
 AMG menu 157
 Audio menu 151
 Convenience submenu 156
 Displaying a service message 218
 Display messages 160
 Factory settings 156
 Important safety notes 146
 Instrument cluster submenu 153
 Lighting submenu 154
 Menu overview 148
 Message memory 160
 Navigation menu 149
 Operation 147
 RACETIMER 157
 Service menu 153
 Settings menu 153
 Standard display 148
 Telephone menu 152
 Trip menu 148
 Vehicle submenu 156
 Video DVD operation 151
- Opening and closing** 67
- Operating system**
 see On-board computer
- Outside temperature display** 147
- Overhead control panel** 32
- P**
- Paint code number** 275
- Paintwork (cleaning instructions)** ... 221
- Panic alarm** 54
- Parcel net** 197
- Parking** 127
 Important safety notes 127
 Position of exterior mirror, front-passenger side 89
 Rear view camera 140
 see PARKTRONIC
- Parking aid**
 see Exterior mirrors
 see PARKTRONIC
- Parking brake**
 Display message 162
 Electric parking brake 129
- Parking lamps**
 Switching on/off 93
- PARKTRONIC**
 Deactivating/activating 139
 Driving system 137
 Function/notes 137
 Problem (malfunction) 140
 Range of the sensors 138
 Warning display 138
- PASSENGER AIR BAG OFF indicator lamp** 42
- Plastic trim (cleaning instructions)** . 225
- Power steering**
 Filling capacity 277
- Power washers** 221

- Power windows**
see Side windows
- Product information** 18
- Program selector** 120
- Protection of the environment**
General notes 18
- Pulling away** 114
- Q**
- Qualified specialist workshop** 22
- R**
- RACE START** 121
- RACETIMER (on-board computer)** 157
- Radio**
Selecting a station 151
see separate operating instructions
- Reading lamp** 95
- Rear spoiler**
Display message 185
Extending/retracting 206
Problem 208
- Rear view camera**
Cleaning instructions 224
Function/notes 140
- Rear-view mirror**
Anti-glare (manual) 87
Dipping (automatic) 88
- Rear window defroster**
Problem (malfunction) 107
Switching on/off 107
- Refueling**
Fuel gauge 27
Important safety notes 124
Refueling process 125
see Fuel
- Remote control**
Garage door opener 208
Programming (garage door
opener) 209
- Reporting safety defects** 23
- Reserve (fuel tank)**
see Fuel
- Reserve fuel**
Display message 175
Warning lamp 192
see Fuel
- Restraint system**
see SRS (Supplemental Restraint
System)
- Roadside Assistance (breakdown)** 20
- Roof**
see Soft top
- Route**
see Route guidance (navigation)
- Route guidance (navigation)** 149
- S**
- Safety**
Children in the vehicle 51
Child restraint systems 51
Occupant Classification System
(OCS) 42
Overview of occupant safety
systems 36
- Safety system**
see Driving safety systems
- Seat belts**
Belt force limiters 50
Cleaning 226
Correct usage 48
Emergency Tensioning Devices 50
Fastening 49
Important safety guidelines 47
Releasing 49
Safety guidelines 37
Special seat belt retractor 53
Warning lamp 187
Warning lamp (function) 49
see Seat belts
- Seats**
Adjusting (electrically) 84
Adjusting lumbar support 84
Cleaning the cover 226
Correct driver's seat position 82
Important safety notes 83
Seat heating problem 85
Storing settings (memory
function) 89

- Switching AIRSCARF on/off 85
- Switching seat heating on/off 84
- Selector lever**
 - Positions 117
- Sensors (cleaning instructions)** 224
- Service interval display**
 - Displaying service messages 218
 - Hiding service messages 218
 - Notes 218
 - Service messages 217
- Service menu (on-board computer)** . 153
- Service products**
 - Brake fluid 280
 - Capacities 277
 - Coolant (engine) 280
 - Engine oil 279
 - Fuel 277
 - Important safety notes 276
 - Notes 276
 - Refrigerant (air-conditioning system) 280
 - Washer fluid 281
- Settings**
 - Factory (on-board computer) 156
 - On-board computer 153
- Setting the air distribution** 105
- Setting the airflow** 106
- SETUP (on-board computer)** 157
- Shift ranges** 122
- Side impact air bag** 40
- Side marker lamp (display message)** 172
- Side windows**
 - Cleaning 223
 - Convenience closing feature 75
 - Convenience opening feature 75
 - Important safety information 73
 - Opening/closing 74
 - Opening/closing (all) 75
 - Problem (malfunction) 76
- SmartKey** 67
 - Changing the battery 64
 - Changing the programming 63
 - Checking the battery 64
 - Convenience closing feature 75
 - Convenience opening feature 75
 - Display message 181
- Door central locking/unlocking 62
- Loss 65
- Mechanical key 63
- Opening/closing soft top 78
- Positions (ignition lock) 113
- Problem (malfunction) 65
- Starting the engine 114
- Unlocking/locking vehicle 67
- SmartKey positions**
 - KEYLESS-GO start function 113
- Snow chains** 250
- Socket**
 - Glove box 200
- Sockets**
 - Center console 200
 - Points to observe before use 200
- Soft top**
 - Cleaning 222
 - Display message 180
 - Important safety notes 76
 - Opening/closing (SmartKey) 78
 - Opening/closing (with soft-top switch) 77
 - Problem (malfunction) 80
 - Relocking 78
 - wind screen 78
- Soft-top switch** 77
- Specialist workshop** 22
- Speed, controlling**
 - see Cruise control
- Speedometer**
 - Activating/deactivating the additional speedometer 154
 - Digital 149
 - In the Instrument cluster 27
 - Selecting the unit of measurement 153
 - see Instrument cluster
- SPORT handling mode**
 - Warning lamp 190
- SRS**
 - see SRS (Supplemental Restraint System)
- SRS (Supplemental Restraint System)**
 - Display message 169
 - Introduction 36

- Warning lamp 190
 - Warning lamp (function) 36
 - Standing lamps**
 - Display message 172
 - Switching on/off 94
 - Starting (engine)** 114
 - Steering wheel**
 - Adjusting (electrically) 86
 - Button overview 29
 - Buttons (on-board computer) 147
 - Cleaning 225
 - Important safety notes 86
 - Paddle shifters 121
 - Storing settings (memory function) 89
 - Stopwatch (RACETIMER)** 157
 - Stowage compartments**
 - Armrest (under) 197
 - Center console 197
 - Cup holders 198
 - Glove box 196
 - Important safety information 196
 - Parcel net 197
 - Rear wall 197
 - Stowage space**
 - Center console (rear) 197
 - Summer opening**
 - see Convenience opening feature
 - Summer tires** 250
 - Sun visor** 198
 - Surround lighting (on-board computer)** 155
 - Suspension tuning**
 - AMG adaptive sport suspension system 136
 - Switching air-recirculation mode on/off** 107
 - Switching off the alarm (ATA)** 58
- T
- Tachometer** 146
 - Tail lamps**
 - Display message 171
 - Tank content**
 - Fuel gauge 27
 - Technical data** 282
 - Notes 274
 - Tires/wheels 270
 - TELEAID**
 - Call priority 205
 - Display message 169
 - Downloading destinations (COMAND) 205
 - Emergency call 202
 - Important safety notes 201
 - Locating a stolen vehicle 206
 - MB info call button 204
 - Remote vehicle locking 205
 - Roadside Assistance button 203
 - Search & Send 205
 - Self-test 201
 - System 201
 - Telephone**
 - Accepting a call 152
 - Menu (on-board computer) 152
 - Number from the phone book 152
 - Redialing 153
 - Rejecting/ending a call 152
 - Temperature**
 - Coolant (on-board computer) 157
 - Engine oil 146
 - Engine oil (on-board computer) 157
 - Outside temperature 147
 - Theft deterrent systems**
 - ATA (Anti-Theft Alarm system) 58
 - Immobilizer 58
 - Theft-deterrent systems**
 - Tow-away alarm 59
 - Timing (RACETIMER)** 157
 - TIREFIT kit** 229
 - Tire pressure**
 - Calling up (on-board computer) 255
 - Checking manually 255
 - Display message 177, 179
 - Maximum 254
 - Notes 252
 - Not reached (TIREFIT) 231
 - Reached (TIREFIT) 231
 - Recommended 251
 - see Tire pressure

- Tire pressure monitoring system**
- Function/notes 255
 - Restarting 257
 - Warning lamp 193
- Tires**
- Aspect ratio (definition) 268
 - Average weight of the vehicle occupants (definition) 267
 - Bar (definition) 266
 - Characteristics 266
 - Checking 249
 - Definition of terms 266
 - Direction of rotation 270
 - Display message 177
 - Distribution of the vehicle occupants (definition) 269
 - DOT, Tire Identification Number (TIN) 266
 - DOT (Department of Transportation) (definition) 266
 - GAWR (Gross Axle Weight Rating) (definition) 267
 - GVW (Gross Vehicle Weight) (definition) 267
 - GVWR (Gross Vehicle Weight Rating) (definition) 267
 - Important safety notes 248
 - Increased vehicle weight due to optional equipment (definition) 267
 - Kilopascal (kPa) (definition) 268
 - Labeling (overview) 263
 - Load bearing index (definition) 269
 - Load index 265
 - Load index (definition) 268
 - Maximum loaded vehicle weight (definition) 267
 - Maximum load on a tire (definition) 268
 - Maximum permissible tire pressure (definition) 268
 - Maximum tire load 261
 - Maximum tire load (definition) 268
 - Optional equipment weight (definition) 269
 - PSI (pounds per square inch) (definition) 268
 - Replacing 269
 - Service life 250
 - Sidewall (definition) 268
 - Speed rating (definition) 267
 - Storing 270
 - Structure and characteristics (definition) 266
 - Technical data 272
 - Temperature 262
 - TIN (Tire Identification Number) (definition) 269
 - Tire bead (definition) 268
 - Tire pressure (definition) 268
 - Tire pressures (recommended) 267
 - Tire size (data) 270
 - Tire size designation, load-bearing capacity, speed rating 263
 - Tire tread 249
 - Tire tread (definition) 268
 - Total load limit (definition) 269
 - Traction 262
 - Traction (definition) 269
 - Tread wear 262
 - Uniform Tire Quality Grading Standards 261
 - Uniform Tire Quality Grading Standards (definition) 267
 - Unladen weight (definition) 268
 - Wear indicator (definition) 269
 - Wheel rim (definition) 267
 - see Flat tire
- Top Tether** 53
- Tow-away alarm** 59
- Towing**
- Important safety guidelines 242
 - Installing the towing eye 243
 - Removing the towing eye 243
 - With the rear axle raised 243
- Towing away**
- With both axles on the ground 244
- Transmission**
- Driving tips 120
 - Selector lever 117
 - Shift range 122
- Transmission position display** 119
- Transmission positions** 119
- Transporting the vehicle** 244
- Trim pieces (cleaning instructions)** . 225
- Trip computer (on-board computer)** 148

Trip odometer

- Calling up 148
- Resetting (on-board computer) 149
- see Trip odometer

Trunk

- Emergency release 73
- Important safety guidelines 71
- Locking separately 72
- Opening (automatically from inside) 72

Trunk lid

- Display message 180
- Opening/closing 71, 72

Trunk load (maximum)

- see Technical data

Turn signals

- Display message 170
- Switching on/off 94
- see Turn signals

Type identification plate

- see Vehicle identification plate

U**Unlocking**

- Emergency unlocking 69
- From inside the vehicle (central unlocking button) 68

Upshift indicator 124**V****Vanity mirror (in the sun visor)** 198**Vehicle**

- Correct use 22
- Data acquisition 23
- Display message 180
- Equipment 19
- Individual settings 153
- Limited Warranty 23
- Loading 258
- Locking (in an emergency) 70
- Locking (SmartKey) 62
- Lowering 236
- Maintenance 20
- Parking for a long period 130
- Raising 233
- Reporting problems 22

- Towing away 242
- Transporting 244
- Unlocking (in an emergency) 69
- Unlocking (SmartKey) 62, 67

Vehicle data

- see Technical data

Vehicle dimensions 283

- see Technical data

Vehicle emergency locking 70**Vehicle identification number**

- see VIN

Vehicle identification plate 275**Vehicle tool kit** 228**Vehicle weights**

- see Technical data

Video (DVD) 151**VIN** 275**W****Warning and indicator lamps**

- ABS 189
- Brakes 186, 189
- Cruise control 135
- Engine diagnostics 191
- ESP® 190
- Fuel tank 192
- Overview 28
- PASSENGER AIR BAG OFF indicator lamp 42
- Reserve fuel 192
- Seat belt 187
- SPORT handling mode 190
- SRS 190
- Tire pressure monitor 193

Warranty 275**Washer fluid**

- Display message 181
- see Windshield washer system

Weight

- see Technical data

Wheel bolt tightening torque 236**Wheel chock** 232**Wheels**

- Changing a wheel 232
- Checking 249
- Cleaning 221
- Important safety notes 248

Interchanging/changing	269
Mounting a new wheel	235
Removing a wheel	235
Storing	270
Tightening torque	236
Wheel size/tire size	270
Windows	
see Side windows	
Windshield washer system	217
Filling capacity	282
Notes	281
Windshield wipers	
Problem (malfunction)	99
Replacing the wiper blades	98
Switching on/off	97
Winter driving	
Important safety notes	250
Slippery road surfaces	134
Snow chains	250
Winter tires	
M+S tires	251
Wiper blades	
Cleaning	223
Important safety notes	98
Replacing	98
Wooden trim (cleaning instructions)	225
Workshops	
see Qualified specialist workshop	

Protection of the environment

General notes

🌱 Environmental note

Daimler's declared policy is one of integrated environmental protection.

The objectives are for the natural resources that form the basis of our existence on this planet to be used sparingly and in a manner that takes the requirements of both nature and humanity into account.

You too can help to protect the environment by operating your vehicle in an environmentally responsible manner.

Fuel consumption and the rate of engine, transmission, brake and tire wear depend on the following factors:

- operating conditions of your vehicle
- your personal driving style

You can influence both factors. You should bear the following in mind:

Operating conditions:

- avoid short trips as these increase fuel consumption.
- always make sure that the tire pressures are correct.
- do not carry any unnecessary weight.
- keep an eye on the vehicle's fuel consumption.
- remove roof racks once you no longer need them.
- a regularly serviced vehicle will contribute to environmental protection. You should therefore adhere to the service intervals.
- always have service work carried out at a qualified specialist workshop.

Personal driving style:

- do not depress the accelerator pedal when starting the engine.
- do not warm up the engine when the vehicle is stationary.
- drive carefully and maintain a safe distance from the vehicle in front.

- avoid frequent, sudden acceleration.
- change gear in good time and use each gear only up to $\frac{2}{3}$ of its maximum engine speed.
- switch off the engine in stationary traffic.

Environmental concerns and recommendations

Wherever the operating instructions require you to dispose of materials, first try to regenerate or re-use them. Observe the relevant environmental rules and regulations when disposing of materials. In this way you will help to protect the environment.

Product information

Mercedes-Benz recommends that you use genuine Mercedes-Benz parts, conversion parts and accessories that have been approved for your vehicle.

Mercedes-Benz tests genuine parts as well as conversion parts and accessories that have been specifically approved for your vehicle for their reliability, safety and suitability. Despite ongoing market research, Mercedes-Benz is unable to assess other parts. Therefore, Mercedes-Benz accepts no responsibility for the use of such parts in Mercedes-Benz vehicles. This is also the case, even if they have been independently or officially approved. The use of non-approved parts could affect your vehicle's operating safety. Genuine Mercedes-Benz parts, approved conversion parts and accessories are available from any authorized Mercedes-Benz Center. Here, you will receive advice about permissible technical modifications, and the parts will be professionally installed.

Operator's Manual

General notes

Before you first drive off, read this Operator's Manual carefully and familiarize yourself with your vehicle.

For your own safety and a longer vehicle life, follow the instructions and warning notices in this manual. Disregarding them may lead to damage to the vehicle or personal injury.

Vehicle damage resulting from the disregard of the instructions is not covered by the Mercedes-Benz Limited Warranty.

Vehicle equipment

This Operator's Manual describes all models and all standard and optional equipment of your vehicle available at the time of going to print. Country-specific differences are possible. Please note that your vehicle may not be equipped with all features described. This also applies to safety-related systems and functions. The equipment in your vehicle may therefore differ from some of the descriptions or illustrations.

The original purchase agreement lists all systems installed in your vehicle.

Contact an authorized Mercedes-Benz Center if you have any questions about equipment or operation.

The Operator's Manual and Maintenance Booklet are important documents and should be kept in the vehicle.

Service and vehicle operation

Service and literature

Your vehicle is covered under the terms of the warranties printed in the Service and Warranty Information booklet. Your authorized Mercedes-Benz Center will exchange or repair any defective parts originally installed in the vehicle in accordance with the terms of the following warranties:

- New Vehicle Limited Warranty
- Emission Systems Warranty
- Emission Performance Warranty
- California, Connecticut, Maine, Massachusetts, New York, Pennsylvania, Rhode Island and Vermont Emission Control Systems Warranty
- State warranty enforcement laws (lemon laws)

Information for customers in California

Under California law you may be entitled to a replacement of your vehicle or a refund of the purchase price or lease price, if after a reasonable number of repair attempts Mercedes-Benz USA, LLC and/or its authorized repair or service facilities fail to fix one or more substantial defects or malfunctions in the vehicle that are covered by its express warranty. During the period of 18 months from original delivery of the vehicle or the accumulation of 18,000 miles (approximately 29,000 km) on the odometer of the vehicle, whichever occurs first, a reasonable number of repair attempts is presumed for a retail buyer or lessee if one or more of the following occurs:

- (1) the same substantial defect or malfunction results in a condition that is likely to cause death or serious bodily injury if the vehicle is driven, that defect or malfunction has been subject to repair two or more times, and you have directly

notified Mercedes-Benz USA, LLC in writing of the need for its repair,

- (2) the same substantial defect or malfunction of a less serious nature than category (1) has been subject to repair four or more times and you have directly notified us in writing of the need for its repair, or
- (3) the vehicle is out of service by reason of repair of the same or different substantial defects or malfunctions for a cumulative total of more than 30 calendar days.

Please send your written notice to:

Mercedes-Benz USA, LLC
Customer Assistance Center
One Mercedes Drive
Montvale, NJ 07645-0350

Maintenance

The Service and Warranty Booklet describes all the necessary maintenance work which should be done at regular intervals.

Always have the Service and Warranty Booklet with you when you bring the vehicle to an authorized Mercedes-Benz Center. The service advisor will record every service for you in the Service and Warranty Booklet.

Roadside Assistance

The Mercedes-Benz Roadside Assistance Program offers technical help in the event of a breakdown. Calls to the toll-free Roadside Assistance Hotline are answered by our agents 24 hours a day, 365 days a year.

**1-800-FOR-MERCEdes(1-800-367-6372)
(USA)**

1-800-387-0100 (Canada)

For additional information, refer to the Mercedes-Benz Roadside Assistance Program brochure (USA) or the "Roadside Assistance" section in the Service and Warranty booklet (Canada). You will find both in your vehicle literature portfolio.

Change of address or change of ownership

In the event of a change of address, please send us the "Notification of Address Change" in the Service and Guarantee booklet or simply call the Mercedes-Benz Customer Assistance Center (USA) at the hotline number

1-800-FOR-MERCEdes(1-800-367-6372) or Customer Service Center (Canada) at 1-800-387-0100. This will assist us in contacting you in a timely manner should the need arise.

If you sell your Mercedes, please leave the entire literature in the vehicle so that it is available to the next owner.

If you have purchased a used car, please send us the "Notification of Used Car Purchase" in the Service and Guarantee booklet or simply call the Mercedes-Benz Customer Assistance Center (USA) at the hotline number 1-800-FOR-MERCEdes(1-800-367-6372) or Customer Service (Canada) at 1-800-387-0100.

Vehicle operation outside the USA and Canada

If you plan to operate your vehicle in foreign countries, please be aware that:

- service facilities or replacement parts may not be readily available.
- unleaded fuel for vehicles with a catalytic converter may not be available. Leaded fuel may cause damage to the catalytic converter.
- the fuel may have a considerably lower octane rating. Unsuitable fuel can cause engine damage.

Some Mercedes-Benz models are available for delivery in Europe through our European Delivery Program. For details, consult an authorized Mercedes-Benz Center or write to one of the following addresses.

In the USA

Mercedes-Benz USA, LLC
 European Delivery Department
 One Mercedes Drive
 Montvale, NJ 07645-0350

In Canada

Mercedes-Benz Canada, Inc.
 European Delivery Department
 98 Vanderhoof Avenue
 Toronto, Ontario M4G 4C9

Operating safety

Important safety notes

WARNING

Work improperly carried out on electronic components and associated software could cause them to cease functioning. Because the vehicle's electronic components are interconnected, any modifications made may produce an undesired effect on other systems. Electronic malfunctions could seriously impair the operating safety of your vehicle.

Contact an authorized Mercedes-Benz Center for repairs or modifications to electronic components.

Other improper work or modifications on the vehicle could also have a negative impact on the operating safety of the vehicle.

Some safety systems only function when the engine is running. You should therefore never turn off the engine while driving.

WARNING

Heavy blows against the vehicle underbody or tires/wheels may cause serious damage and impair the operating safety of your vehicle. Such blows can be caused, for example, by running over an obstacle, road debris or a pothole.

If you feel a sudden significant vibration or ride disturbance, or you suspect that damage to your vehicle has occurred:

- turn on your hazard warning flashers.
- slow down carefully.
- drive with caution to an area which is a safe distance from the road.

Inspect the vehicle underbody and tires/wheels for possible damage. If the vehicle appears unsafe, have it towed to the nearest authorized Mercedes-Benz Center or other qualified maintenance or repair facility for further inspection or repairs.

Declarations of conformity

Vehicle components which receive and/or transmit radio waves

USA: "The wireless devices of this vehicle comply with Part 15 of the FCC Rules. Operation is subject to the two following two conditions: 1) These devices may not cause harmful interference, and 2) These devices must accept any interference received, including interference that may cause undesired operation. Changes or modifications not expressly approved by the party responsible for compliance could void the user's authority to operate the equipment."

Canada: "The wireless devices of this vehicle comply with Industry Canada license-exempt RSS standard(s). Operation is subject to the following two conditions: (1) These devices may not cause interference, and (2) These devices must accept any interference, including interference that may cause undesired operation of the device."

Diagnostics connection

WARNING

If you connect equipment to the on-board diagnostics connection, it can affect the

operation of the vehicle systems. This can impair the operating safety of your vehicle while driving. There is a risk of an accident. Do not connect any equipment to the on-board diagnostics connection.

WARNING

Loose equipment or equipment cables which are connected to the on-board diagnostics connection can obstruct the area around the pedals. The equipment or the cables could come between the pedals in the event of sudden braking or acceleration. This may affect the function of the pedals. There is a risk of an accident.

Do not attach any equipment or cables in the driver's footwell.

! If the engine is switched off and equipment on the diagnostics connection is used, the starter battery may discharge.

The diagnostics connection is only intended for the connection of diagnostic equipment at a qualified specialist workshop.

Connecting equipment to the diagnostics connection can, for example, lead to emissions monitoring information being reset. This may lead to the vehicle failing to meet the requirements of the next emissions test during the main inspection.

Qualified specialist workshop

An authorized Mercedes-Benz Center is a qualified specialist workshop. It has the necessary specialist knowledge, tools and qualifications to correctly carry out the work required on your vehicle. This is especially the case for work relevant to safety.

Observe the notes in the Maintenance Booklet.

Always have the following work carried out at an authorized Mercedes-Benz Center:

- work relevant to safety
- service and maintenance work

- repair work
- alterations, installation work and modifications
- work on electronic components

Correct use

WARNING

There are various warning stickers affixed to your vehicle. Their purpose is to alert you and others to various dangers. Therefore, do not remove any warning stickers unless the sticker clearly states that you may do so.

If you remove any warning stickers, you or others could fail to recognize certain dangers and be injured.

When driving your vehicle observe the following information:

- the safety notes in this manual
- the Technical Data section in this manual
- traffic rules and regulations
- laws and safety standards pertaining to motor vehicles

Problems with your vehicle

If you should experience a problem with your vehicle, particularly one that you believe may affect its safe operation, we urge you to contact an authorized Mercedes-Benz Center immediately to have the problem diagnosed and rectified. If the problem is not resolved to your satisfaction, please discuss the problem again with a Mercedes-Benz Center or contact us at one of the following addresses.

In the USA

Customer Assistance Center
Mercedes-Benz USA, LLC
One Mercedes Drive
Montvale, NJ 07645-0350

In Canada

Customer Relations Department
Mercedes-Benz Canada, Inc.

98 Vanderhoof Avenue
Toronto, Ontario M4G 4C9

Reporting safety defects

USA only:

The following text is published as required of manufacturers under Title 49, Code of U.S. Federal Regulations, Part 575 pursuant to the "National Traffic and Motor Vehicle Safety Act of 1966".

If you believe that your vehicle has a defect which could cause a crash or could cause injury or death, you should immediately inform the National Highway Traffic Safety Administration (NHTSA) in addition to notifying Mercedes-Benz USA, LLC.

If NHTSA receives similar complaints, it may open an investigation, and if it finds that a safety defect exists in a group of vehicles, it may order a recall and remedy campaign. However, NHTSA cannot become involved in individual problems between you, your dealer, or Mercedes-Benz USA, LLC.

To contact NHTSA, you may call the Vehicle Safety Hotline toll-free at 1-888-327-4236 (TTY: 1-800-424-9153); go to <http://www.safercar.gov>; or write to: Administrator, NHTSA, 400 Seventh Street, SW., Washington, DC 20590.

You can also obtain other information about motor vehicle safety from

<http://www.safercar.gov>

Limited Warranty

! Follow the instructions in this manual about the proper operation of your vehicle as well as about possible vehicle damage. Damage to your vehicle that arises from culpable contraventions against these instructions is not covered either by the Mercedes-Benz Limited Warranty or by the New or Used-Vehicle Warranty.

Information on copyright

General information

You can find information on licenses for free and open-source software used in your vehicle and its electronic components on the following website:

<http://www.mercedes-benz.com/opensource>

Data stored in the vehicle

Information about electronic data acquisition in the vehicle

(Including notice pursuant to California Code § 9951)

Your vehicle records electronic data. If your vehicle is equipped with mbrace (Canada: TELE AID), data is transmitted in the event of an accident.

This information helps, for example, to test vehicle systems after an accident and to continually improve vehicle safety. Daimler AG can access this data and submit it:

- for safety research or vehicle diagnosis purposes
- with the consent of the vehicle owner
- on the instruction of prosecuting authorities
- for use in arbitration of disputes that involve Daimler AG, its affiliates or its sales and service organizations
- as otherwise required or permitted by law.

Please check your mbrace (Canada: TELE AID) purchase agreement to find out more about data that can be recorded and transmitted by this system.

Dashboard	26
Instrument cluster	27
Multifunction steering wheel	29
Center console	30
Overhead control panel	32
Door control panel	33

Dashboard

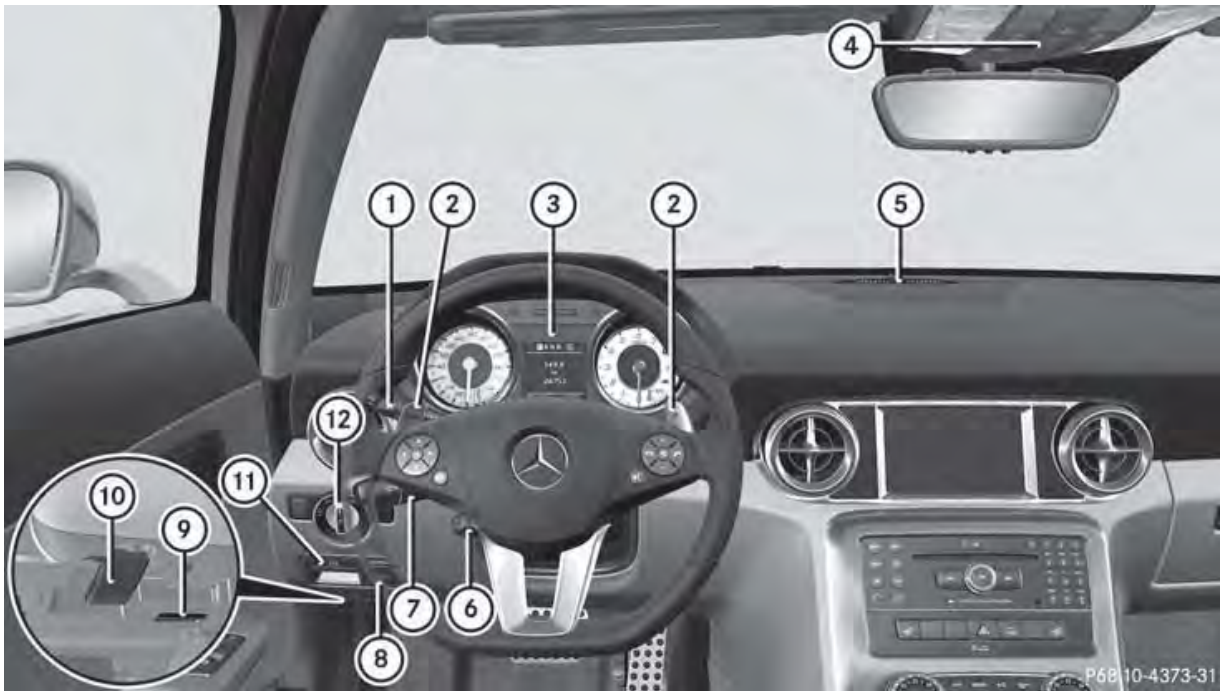

	Function	Page
①	Cruise control lever	135
②	Steering wheel paddle shifters	121
③	Instrument cluster	27
④	Overhead control panel	32
⑤	PARKTRONIC display	138
⑥	Adjusts the steering wheel electrically	86

	Function	Page
⑦	Combination switch	94
⑧	Unlocks the trunk	72
⑨	Diagnostics connection	21
⑩	Opens the hood	214
⑪	Electric parking brake	129
⑫	Light switch	92

Instrument cluster

Overview

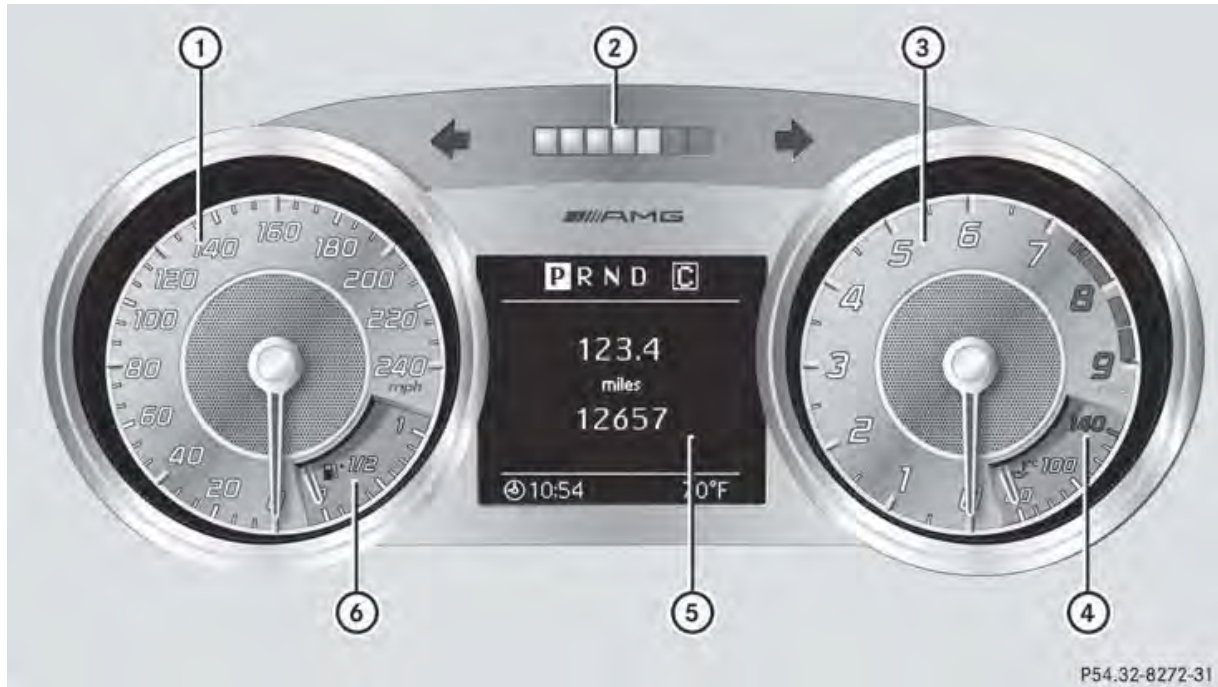

	Function	Page
①	Speedometer	
②	Upshift indicator	124
③	Tachometer	146
④	Engine oil temperature display	146

	Function	Page
⑤	Multifunction display	147
⑥	Fuel gauge	

Warning and indicator lamps

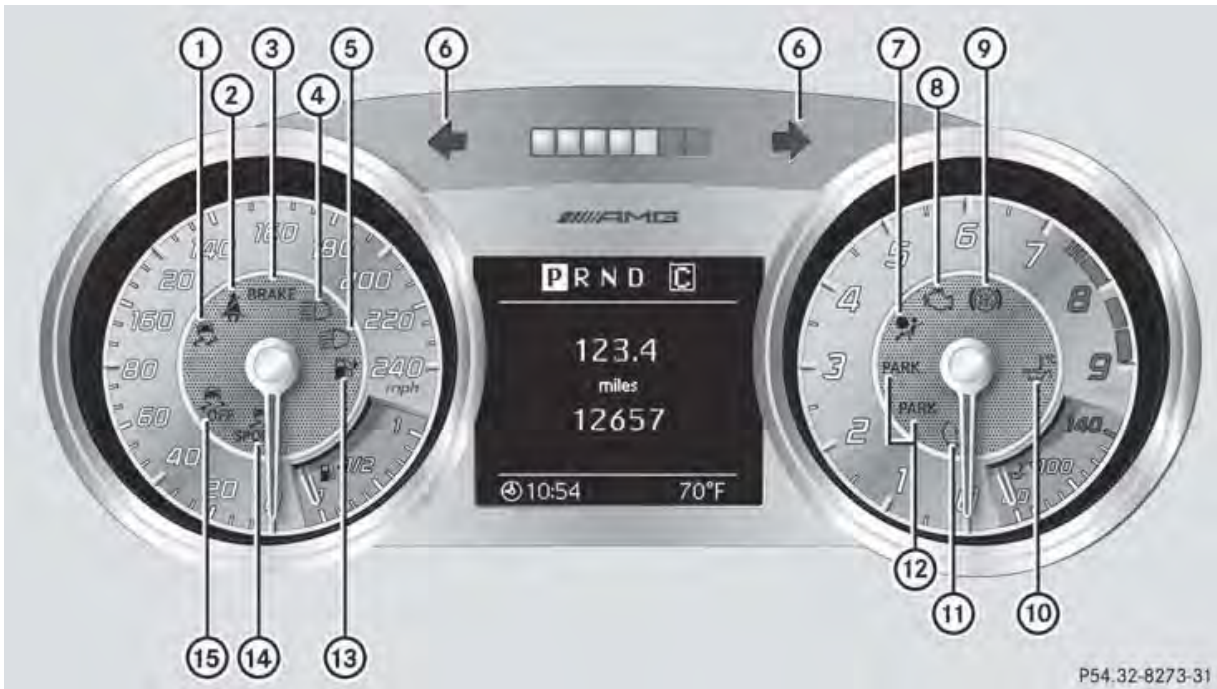

P54.32-8273-31

	Function	Page
①	ESP®	190
②	Seat belts	187
③	Brakes (USA only) Ⓛ Brakes (Canada only)	
④	High-beam headlamps	94
⑤	Low-beam headlamps	93
⑥	Turn signal	94
⑦	SRS	190
⑧	Check Engine	
⑨	ABS	189

	Function	Page
⑩	Engine oil temperature	146
⑪	Tire pressure	193
⑫	Electric parking brake (USA only) Ⓟ Electric parking brake (Canada only)	
⑬	Reserve fuel	192
⑭	SPORT handling mode	56
⑮	ESP® OFF	56

Multifunction steering wheel



At a glance

	Function	Page
①	Multifunction display	147
②	COMAND with display; see the separate operating instructions	
③	Makes/accepts or rejects/ends a call Increases/reduces volume Mute	152
④	Switches on the Voice Control System; see the separate operating instructions	

	Function	Page
⑤	Back or deactivates the Voice Control System	
⑥	Selects a menu Selects a submenu or scrolls through lists Confirms selections and hides display messages	147

Center console

Upper section

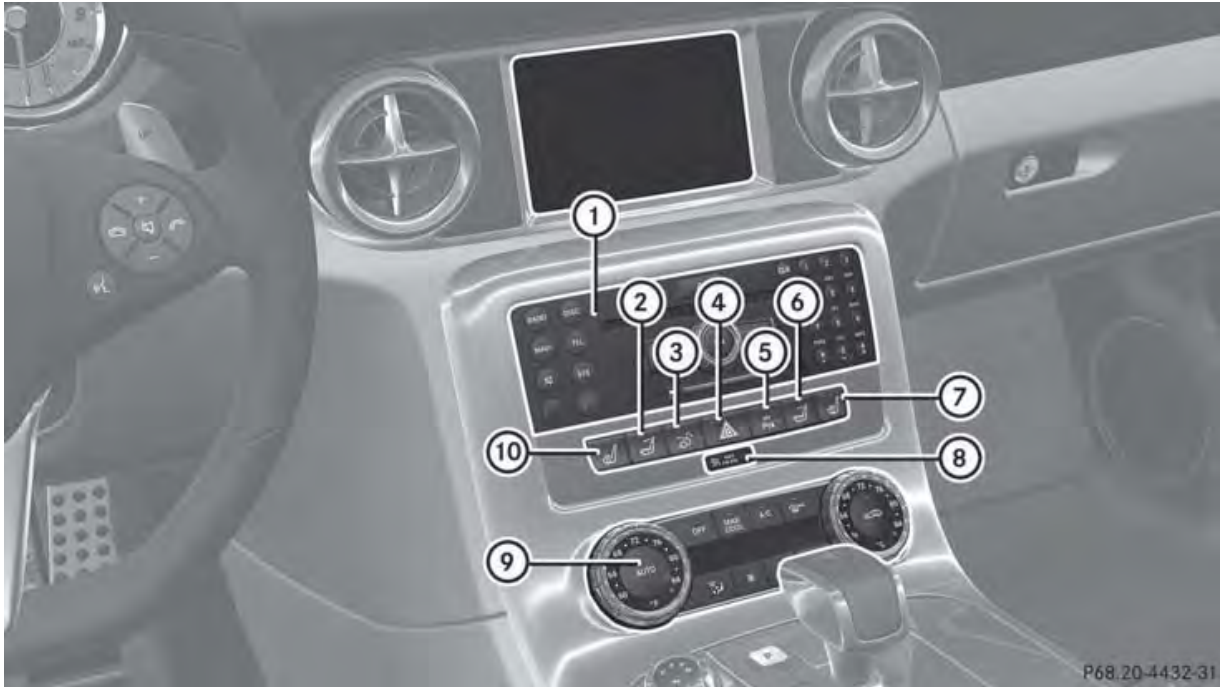

P68.20-4432-31

	Function	Page
①	Controls COMAND; see the separate operating instructions	
②	Adjusts AIRSCARF, left (Roadster only)	109
③	Retracts/extends rear spoiler (vehicles with AMG adaptive sport suspension system)	206
④	Hazard warning lamps	94
⑤	PARKTRONIC	139

	Function	Page
⑥	Adjusts AIRSCARF, right (Roadster only)	109
⑦	Seat heating, right	84
⑧	 PASSENGER AIR BAG OFF indicator lamp	42
⑨	Operates dual-zone automatic climate control	103
⑩	Seat heating, left	84

Lower section

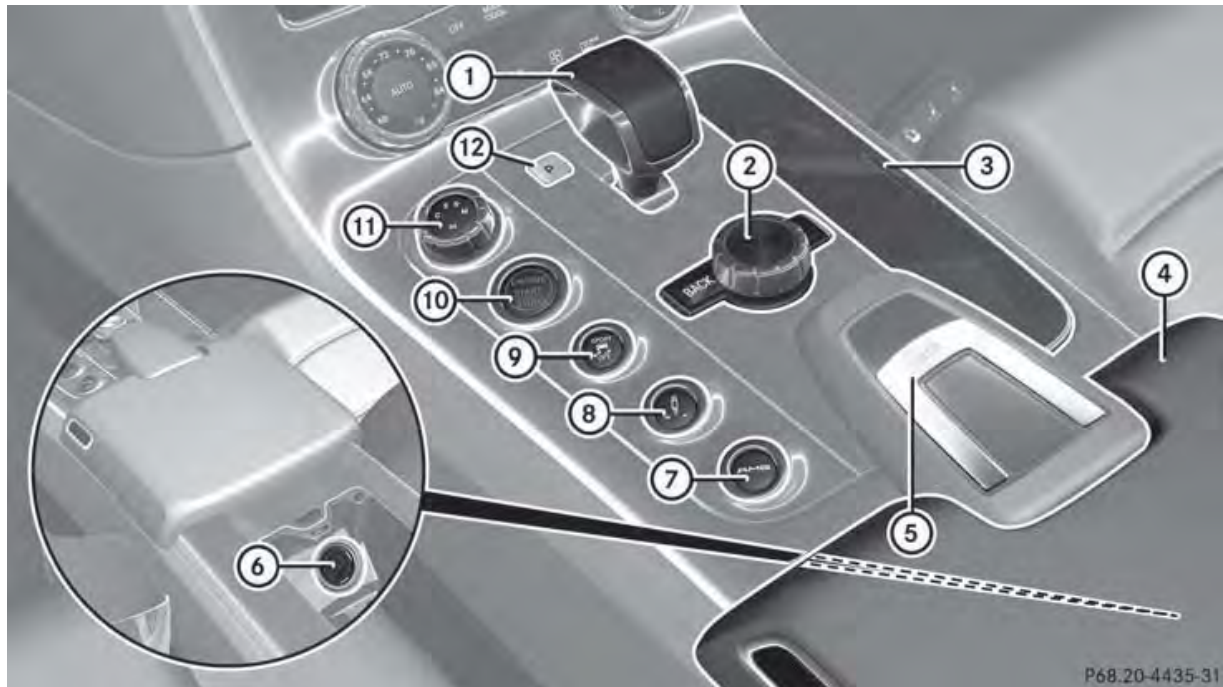







P68.20-4435-31

	Function	Page		Function	Page
①	AMG E-SELECT selector lever	117	⑧	Adjusts AMG adaptive sport suspension system	136
②	COMAND controller			Retracts/extends rear spoiler (vehicles without AMG adaptive sport suspension system)	206
③	Stowage compartment	197	⑨	Activates/deactivates ESP®	56
	12 V socket	200		Activates/deactivates SPORT handling mode	56
	Ashtray	199	⑩	Start/Stop button	113
	Cigarette lighter	199	⑪	Selecting the drive program	120
④	Stowage compartment with cup holder	197	⑫	Parking lock button P	117
⑤	Soft top switch (Roadster only)	77			
⑥	Ignition lock (behind stowage space)	113			
⑦	Calls up/stores AMG menu (SETUP)	124			

Overhead control panel







P82.00-2769-31

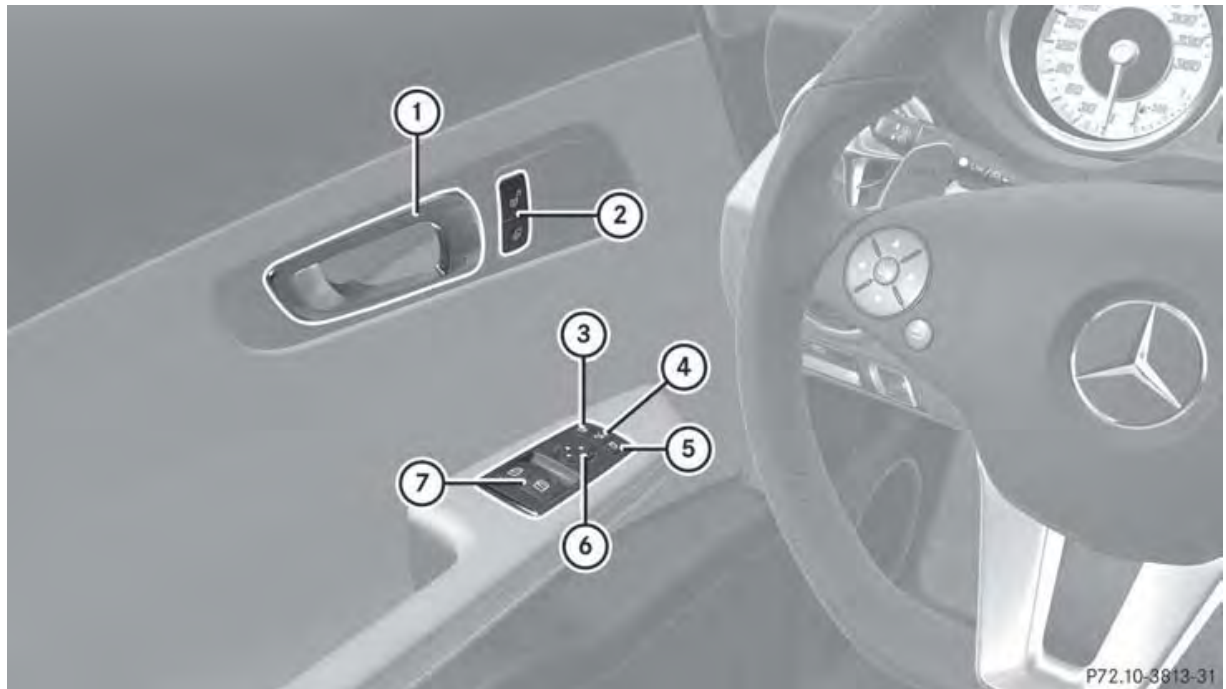

	Function	Page
①	 Switches the left-hand reading lamp on/off	95
②	 Switches the interior lighting on/off	96
③	 Switches the automatic interior lighting control on/off	95
④	 Switches the right-hand reading lamp on/off	95
⑤	 MB Info call button (mbrace system)	204
⑥	 SOS button (mbrace system)	202

	Function	Page
⑦	Rear-view mirror	87
⑧	Transmitter buttons for the garage door opener	208
⑨	Microphone for mbrace (emergency call system) telephone and the Voice Control System	
⑩	 Roadside Assistance call button (mbrace system)	203

Door control panel



	Function	Page
①	Opens the door	68
②	  Locks/unlocks the vehicle	68
③	 Selects the left exterior mirror	87
④	 Folds the exterior mirrors in/out electrically	88

	Function	Page
⑤	 Selects the right exterior mirror	87
⑥	 Adjusts the exterior mirrors	87
⑦	 Opens/closes the side windows	74

Useful information	36
Occupant safety	36
Children in the vehicle	51
Panic alarm	54
Driving safety systems	54
Theft deterrent locking system	58

Useful information

- i** This Operator's Manual describes all models and all standard and optional equipment of your vehicle available at the time of publication of the Operator's Manual. Country-specific differences are possible. Please note that your vehicle may not be equipped with all features described. This also applies to safety-related systems and functions.
- i** Please read the information on qualified specialist workshops (▷ page 22).

Occupant safety

Introduction

In this section, you will learn the most important facts about the restraint system components of the vehicle.

The restraint system consists of:

- seat belts
- child restraint systems

Additional protection is provided by:

- SRS (Supplemental Restraint System)
- air bag system components with:
 - PASSENGER AIR BAG OFF indicator lamp
 - front-passenger seat with Occupant Classification System (OCS)

The different air bag systems work independently of each other. The protective functions of the system work in conjunction with each other. Not all air bags are deployed in an accident.

WARNING

Modifications to or work improperly conducted on restraint system components or their wiring, as well as tampering with interconnected electronic systems, can lead to the restraint systems no longer functioning as intended.

Air bags or Emergency Tensioning Devices (ETDs), for example, could deploy

inadvertently or fail to deploy in accidents although the deceleration threshold for air bag deployment is exceeded. Therefore, never modify the restraint systems. Do not tamper with electronic components or their software.

- i** See "Children in the vehicle" (▷ page 51) for more information on infants and children traveling with you in the vehicle and restraints for infants and children.

SRS (Supplemental Restraint System)

Introduction

SRS reduces the risk of occupants coming into contact with the vehicle's interior in the event of an accident. It can also reduce the effect of the forces to which occupants are subjected during an accident.

SRS consists of:

-  SRS warning lamp
- air bags
- air bag control unit (with crash sensors)
- Emergency Tensioning Devices
- seat belt force limiters

SRS warning lamp

SRS functions are checked regularly when you switch on the ignition and when the engine is running. Therefore, malfunctions can be detected in good time.

The  SRS warning lamp in the instrument cluster lights up when the ignition is switched on. It goes out no later than a few seconds after the engine is started.

⚠ WARNING

The SRS self-check has detected a malfunction if the  SRS indicator lamp:

- does not light up at all
- does not go out after approximately four seconds after the engine is started
- comes on after the engine was started or while driving.

For your safety, Mercedes-Benz strongly recommends that you have the system checked as soon as possible at an authorized Mercedes-Benz Center. SRS may otherwise fail to activate when it is needed in the event of an accident, which could lead to serious or fatal injuries. SRS might also be activated unexpectedly and unnecessarily, which could also result in injury.

In addition, work carried out improperly on SRS may render SRS inoperative or cause unintended air bag deployment. Work on the SRS system should only be carried out by qualified specialist personnel. Consult an authorized Mercedes-Benz Center.

If it is necessary to modify an air bag system to accommodate a person with disabilities, contact an authorized Mercedes-Benz Center for details. USA only: for further information contact our Customer Assistance center at 1-800-FOR-MERcedes (1-800-367-6372).

Safety guidelines for seat belts, Emergency Tensioning Devices (ETDs) and air bags

⚠ WARNING

- Damaged seat belts or seat belts that have been subjected to stress in an accident must be replaced. Their anchoring points must also be checked. Only use seat belts installed or supplied by an authorized Mercedes-Benz Center.
- Air bags and pyrotechnic Emergency Tensioning Devices (ETDs) contain perchlorate material, which may require special handling and regard for the

environment. Check your national disposal guidelines. California residents, see www.dtsc.ca.gov/HazardousWaste/Perchlorate/index.cfm.

- Air bags and ETDs are designed to function on a one-time-only basis. An air bag or ETD that has deployed must be replaced.
- Do not pass seat belts over sharp edges. They could tear.
- Do not make any modification that could change the effectiveness of the seat belts.
- Do not bleach or dye seat belts as this may severely weaken them. In a crash they may not be able to provide adequate protection.
- No modifications of any kind may be made to any components or wiring of the SRS.
- Do not change or remove any component or part of the SRS.
- Do not install additional trim material, seat covers, badges, etc. over the steering wheel hub, front-passenger front air bag cover, outer sides of the seat backrests, door trim panels, or door frame trims.
- Do not install additional electrical/electronic equipment on or near SRS components and wiring.
- Keep area between air bags and occupants free of objects (e.g. packages, purses, umbrellas, etc.).
- Air bag system components will be hot after an air bag has inflated. Do not touch them.
- Never place your feet on the instrument panel, dashboard, or on the seat. Always keep both feet on the floor in front of the seat.
- Improper repair work on the SRS creates a risk of rendering the SRS inoperative or causing unintended air bag deployment. Work on the SRS must therefore only be performed by qualified technicians. Contact an authorized Mercedes-Benz Center.
- For your protection and the protection of others, when scrapping the air bag unit or ETD, our safety instructions must be

followed. These instructions are available from any authorized Mercedes-Benz Center.

- Given the considerable deployment speed, required inflation volume, and the material of the air bags, there is the possibility of abrasions or other, potentially more serious injuries resulting from air bag deployment.

If you sell your vehicle, Mercedes-Benz strongly recommends that you inform the subsequent owner that the vehicle is equipped with SRS. Also, refer them to the applicable section in the Operator's Manual.

Air bags

Important safety notes

WARNING

Air bags are designed to reduce the potential of injury and fatality rates in certain situations:

- frontal impacts (driver's and front-passenger front air bags and knee bags)
- side impacts (head bags and side impact air bags)

However, no system available today can completely eliminate injuries and fatalities.

When the air bags are deployed, a small amount of powder temporarily comes out of the air bags. This powder generally does not constitute a health hazard and does not indicate that there is a fire in the vehicle. In order to prevent potential breathing difficulties, you should leave the vehicle as soon as it is safe to do so. If you have any breathing difficulty but cannot get out of the vehicle, then get fresh air by opening a side window or door.

WARNING

In order to reduce the potential danger of injuries caused during the deployment of the front air bags, the driver and front passenger

must always be correctly seated and wear their seat belts.

For maximum protection in the event of a collision, you must always be in the normal seat position with your back against the backrest. Fasten your seat belt and make sure that it is correctly positioned on your body.

As the air bag inflates with considerable speed and force, a proper seating position and correct positioning of the hands on the steering wheel will help to keep you at a safe distance from the air bag. Occupants who are not wearing their seat belt, are not seated properly or are too close to the air bag can be seriously injured or killed by an air bag as it inflates with great force instantaneously:

- sit with the seat belt fastened correctly and in a position that is as upright as possible with your back against the backrest.
- move the driver's seat as far back as possible, still permitting proper operation of vehicle controls. The distance from the center of the driver's chest to the center of the air bag cover on the steering wheel must be at least 10 inches (25 cm) or more. You should be able to accomplish this by adjusting the seat and steering wheel. If you have any difficulties, please contact an authorized Mercedes-Benz Center.
- do not lean your head or chest close to the steering wheel or dashboard.
- only hold the steering wheel on the outside. Placing hands and arms inside the rim can increase the risk and potential severity of hand/arm injury when the driver front air bag inflates.
- adjust the front-passenger seat as far back as possible from the dashboard when the seat is occupied.
- Occupants, especially children, should never place their bodies or lean their heads in the area of the door or the seat where the head bag or side impact air bag inflates. This could result in serious injuries or death should the head bag or side impact air bag be deployed. Always sit as upright as

possible, wear the seat belt properly and use an appropriately sized infant restraint, toddler restraint, or booster seat recommended for the size and weight of the child.

Failure to follow these instructions can result in severe injuries to you or other occupants.

If you sell your vehicle, it is important that you make the buyer aware of this safety information. Be sure to give the buyer this Operator's Manual.

WARNING

There is a possibility of a head bag- or side impact air bag-related injury if occupants, especially children, are not properly seated or restrained when next to a head bag or side impact air bag that needs to deploy rapidly in a side impact in order to do its job.

To help avoid the possibility of injury, please follow these guidelines:

- (1) Occupants, especially children, should never place their bodies or lean their heads in the area of the door or the seat where the head bag or side impact air bag inflates. This could result in serious injuries or death should the head bag or side impact air bag be deployed.
- (2) Always sit as upright as possible, and use the seat belts properly. Make sure that children 12 years old and under use an appropriately sized infant restraint, toddler restraint or booster seat recommended for the size and weight of the child.
- (3) Always wear seat belts properly.

If you believe that, even with the use of these guidelines, it would be safer for your passenger seat occupants to have the passenger side head bag or side impact air bag deactivated, then deactivation can be carried out upon your written request at an authorized Mercedes-Benz Center at an additional cost.

Please contact an authorized Mercedes-Benz Center or call the Customer Assistance Center (in the USA) at 1-800-FOR-MERCEdes (1-800-367-6372), or Customer Service (in Canada) at 1-800-387-0100 for details.

The air bags are only deployed if the air bag control unit detects the need for deployment. Only in the event of such a situation, will the air bags provide their supplemental protection.

The driver and passenger should always wear their seat belts. Otherwise it is not possible for the air bags to provide their supplemental protection.

In case of other types of impacts and impacts below air bag deployment thresholds, air bags will not deploy. The driver and passenger will then be protected to the extent possible by a properly fastened seat belt. A properly fastened seat belt is also needed to provide the best possible protection in a rollover.

Air bags provide additional protection; they are not, however, a substitute for seat belts. All vehicle occupants must fasten their seat belts regardless of whether your vehicle is equipped with air bags or not.

It is important for your safety and that of your passengers to have deployed air bags replaced and to have any malfunctioning air bags repaired. This will help to make sure the air bags continue to perform their protective function for the vehicle occupants in the event of an accident.

Front air bags

The front air bags increase protection for the driver's and front-passenger's head and chest.



Driver's air bag ① deploys in front of the steering wheel; front-passenger front air bag ② deploys in front of and above the glove box. They are deployed:

- in the event of certain frontal impacts
- if the system determines that air bag deployment can offer additional protection to that provided by the seat belt
- depending on whether the seat belt is being used
- independently of other air bags in the vehicle

If the vehicle rolls over, the front air bags are generally not deployed. If the system detects high vehicle deceleration in a longitudinal direction, the front air bags are deployed.

Your vehicle has adaptive, two-stage front air bags. In the event of a collision, the air bag control unit evaluates the vehicle deceleration. When the first deployment threshold is reached, the front air bag is filled with enough propellant gas to reduce the risk of injuries. The front air bag is fully deployed if a second deployment threshold is exceeded within a few milliseconds.

The deployment of the front-passenger front air bag is also influenced by the weight category of the front passenger, which is determined by the Occupant Classification System (OCS) (▷ page 42).

The front air bags are not deployed in situations where a low impact severity is predicted. You will then be protected by the fastened seat belt.

The front-passenger front air bag will only be deployed if:

- the Occupant Classification System (OCS) has detected that the front-passenger seat is occupied
- the  indicator lamp on the center console is not lit
- the air bag control unit predicts a high-impact severity.

Driver's/front-passenger knee bag

The driver and front-passenger knee bags enhance the level of protection against:

- knee injuries
- thigh injuries
- lower leg injuries



Driver's knee bag ① deploys underneath the steering column. Front-passenger knee bag ② deploys underneath the glove box. If, during a frontal collision, the system determines that air bag deployment can offer additional protection to that provided by the seat belt, the knee bags are deployed along with the front air bags. The knee bags operate best in conjunction with correctly positioned and fastened seat belts.

Side impact air bags

WARNING

The pressure sensors for side impact air bag control are located in the doors. Do not modify any components of the doors or door

trim panels including, for example, the addition of door speakers.

Improper repair work on the doors or the modification or addition of components to the doors create a risk of rendering the side impact air bags inoperative or causing unintended air bag deployment. Work on the doors must therefore only be performed by qualified technicians. Contact an authorized Mercedes-Benz Center.

WARNING

Only use seat covers which have been tested and approved by Mercedes-Benz for your vehicle model. Using other seat covers may interfere with or prevent the deployment of the side impact air bags. Contact an authorized Mercedes-Benz Center for availability.

When deployed, the side impact air bags offer additional protection for the thorax of the vehicle occupants on the side of the vehicle on which the impact occurs. However, they do not protect the:

- head
- neck
- arms



Example: Coupe

Side impact air bags ① deploy next to the outer seat cushions.

The side impact air bags are deployed:

- on the side on which an impact occurs
- at the start of an accident with a high rate of lateral vehicle deceleration or acceleration, e.g. in a side impact
- independently of the use of the seat belt
- independently of the front air bags
- independently of the ETDs

If the vehicle rolls over, the side impact air bags are generally not deployed. They are deployed if the system detects high vehicle deceleration or acceleration in a lateral direction and determines that side impact air bag deployment can offer additional protection to that provided by the seat belt. Side impact air bags will not deploy in side impacts which do not exceed the system's preset deployment thresholds for lateral acceleration/deceleration. You will then be protected by the fastened seat belt.

If the OCS detects that the front-passenger seat is not occupied and the front-passenger seat belt is not fastened (the belt tongue is not engaged in the seat belt buckle), the side impact air bag on the front-passenger side will not deploy. The side impact air bag on the front-passenger side will deploy if the front-passenger seat belt is fastened, regardless of whether the front-passenger seat is occupied or not.

Head bags

The head bags enhance the level of protection for the head (but not chest or arms) of the vehicle occupants on the side of the vehicle on which the impact occurs.

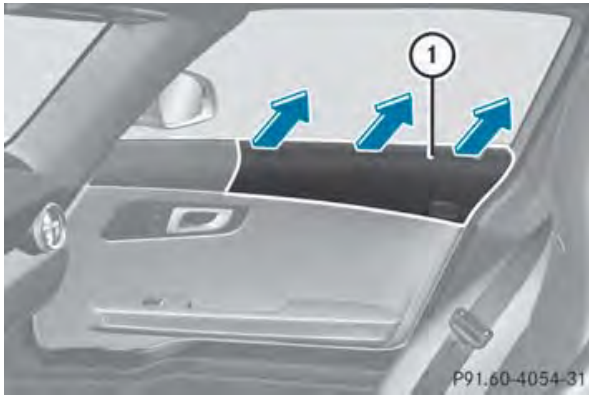

Example: Coupe

Headbags ① deploy in the side window area. They are deployed:



- on the side on which an impact occurs
- at the start of an accident with a high rate of lateral vehicle deceleration or acceleration, e.g. in a side impact
- if the system determines that the vehicle occupants are offered additional protection to that provided by the seat belt
- independently of the use of the seat belt
- independently of the ETDs
- on the driver's side and passenger side, in the event of a vehicle rollover and if the system determines that air bag deployment can offer the vehicle occupants additional protection to that provided by the seat belt
- independently of the front air bags

Head bags ① will not deploy in side impacts which do not exceed the system's preset deployment thresholds for lateral acceleration/deceleration. You will then be protected by the fastened seat belt.

If the OCS has classified the front-passenger seat as unoccupied and the front-passenger seat belt is not fastened, the head bag on the passenger side will not deploy. The head bag on the front-passenger side will deploy if the front-passenger seat belt is fastened, regardless of whether the front-passenger seat is occupied or not.

Occupant Classification System (OCS)

How the Occupant Classification System works

The Occupant Classification System (OCS) categorizes the occupant on the front-passenger seat using a weight sensor. The front-passenger front air bag and the front-passenger knee bag are deactivated automatically for certain weight categories. The  indicator lamp shows you the current status. When the  indicator lamp is illuminated, the front-passenger front air bag and the front-passenger knee bag are deactivated.

The system does not deactivate:

- the front-passenger side impact air bag
- the front-passenger head bag
- the Emergency Tensioning Devices

To be classified correctly, the front passenger must sit:

- with the seat belt fastened correctly
- in a position that is as upright as possible with their back against the seat backrest
- with their feet on the floor



If the front-passenger's weight is transferred to another object in the vehicle (e.g. by leaning on armrests), OCS may not be able to approximate the occupant's weight category.

To establish whether the front passenger is being properly detected, both the driver and the front passenger should pay attention to the  indicator lamp.

If the front-passenger seat, the seat cover or the seat cushion are damaged, have the necessary repair work carried out at an authorized Mercedes-Benz Center.

For safety reasons, Mercedes-Benz recommends that you only use seat accessories that have been approved by Mercedes-Benz.

WARNING



If the  indicator lamp lights up when the front-passenger seat is occupied by an adult or a larger person, ask the passenger to reposition themselves on the seat so that the  indicator lamp goes out.

In the event of a collision, the air bag control unit will not allow front-passenger front air bag and front-passenger knee bag deployment when the OCS has classified the front-passenger occupant as weighing as much as or less than a typical 12-month-old child in a standard child restraint or if the front-passenger seat is classified as being unoccupied.

If OCS has detected that the front passenger weighs the same as or less than a typical 12-month-old child in a standard child restraint system, the  indicator lamp lights up when the engine is started and remains lit. This indicates that the front-passenger front air bag is deactivated.

If OCS determines that the front-passenger seat is unoccupied, the  indicator lamp lights up once the engine has been started and remains lit. This shows that the front-passenger front air bag and front-passenger knee bag are deactivated.

If OCS determines that the front passenger weighs more than a typical 12 month old child in a standard child restraint system and classifies this as a small person (e.g. a teenager or small adult), the  indicator lamp lights up for approximately 6 seconds when the engine is started.

Depending on occupant weight sensor readings from the seat, it will then remain illuminated or go out. If the  indicator lamp is illuminated, the front-passenger front air bag is deactivated. With the  indicator lamp out, the front-passenger front air bag and front-passenger knee bag are deactivated.

If OCS has determined that the front passenger is an adult or medium sized person, the  indicator lamp lights up for

approximately 6 seconds when the engine is started and then goes out. This shows that the front-passenger front air bag and front-passenger knee bag are activated.

If the  indicator lamp is illuminated, the front-passenger front air bag and the front-passenger knee bag are deactivated and are not deployed.

If the  indicator lamp does not light up, the front-passenger air bag is enabled and will be deployed:

- in the event of certain frontal impacts
- if the impact exceeds a preset deployment threshold
- independently of the other air bags

If the front-passenger air bag is deployed, the rate of inflation is influenced by:

- the rate of vehicle deceleration as assessed by the air bag control unit
- the front passenger's weight category as determined by the OCS

For further information, see "Air bag display messages" (▷ page 167).





WARNING

Children 12 years old and under must be seated and properly secured in an appropriate infant restraint, toddler restraint, or booster seat recommended for the size and weight of the child.

The infant or child restraint must be properly secured with the vehicle's seat belt fully in accordance with the child seat manufacturer's instructions.

Occupants, especially children, should always sit as upright as possible, wear the seat belt properly and use an appropriately sized infant restraint, toddler restraint, or booster seat recommended for the size and weight of the child.

Children can be killed or seriously injured by an inflating air bag. Note the following important information:

- Your vehicle is equipped with air bag technology designed to deactivate the front-passenger front air bag in your vehicle when the system senses the weight of a typical 12-month-old child or less along with the weight of a standard appropriate child restraint on the front-passenger seat.
- A child in a rear-facing child restraint on the front-passenger seat will be seriously injured or even killed if the front-passenger front air bag inflates in a collision which could occur under some circumstances, even with the air bag technology installed in your vehicle.
- If you install a rear-facing child restraint on the front-passenger seat, make sure the  **PASS AIR BAG OFF** indicator lamp is illuminated, indicating that the front-passenger front air bag is deactivated. Should the  **PASS AIR BAG OFF** indicator lamp not illuminate or go out while the restraint is installed, please check installation. Periodically check the  **PASS AIR BAG OFF** indicator lamp while driving to make sure the  **PASS AIR BAG OFF** indicator lamp is illuminated. If the  **PASS AIR BAG OFF** indicator lamp goes out or remains out, do not transport a child on the front-passenger seat until the system has been repaired.

A child in a rear-facing child restraint on the front-passenger seat will be seriously injured or even killed if the front-passenger front air bag inflates.

- If you place a child in a forward-facing child restraint on the front-passenger seat:
 - move the seat as far back as possible
 - use the proper child restraint recommended for the age, size and weight of the child
 - secure child restraint with the vehicle's seat belt according to the child seat manufacturer's instructions
- For children larger than a typical 12-month-old child, the front-passenger front air bag may or may not be activated.

If the driver's air bag deploys, this does not mean that the front-passenger front air bag also has to deploy.

The OCS may have detected that the seat:

- is empty or occupied by a person with a weight of up to or less than that of a typical 12-month-old child seated in a standard child restraint
- is occupied by a small individual, such as a young teenager or a small adult
- is occupied by a child in a child restraint system whose weight is greater than that of a typical 12-month-old child.



These are examples of when the OCS deactivates the front-passenger front air bag and front-passenger knee bag. Deactivation takes place although the collision fulfills the criteria for deploying the driver's air bag.



If the SmartKey has been removed from the ignition lock or has been set to position **0** with

the Start/Stop button,  indicator lamp ① does not light up.

WARNING

If the red  SRS warning lamp in the instrument cluster and the , the OCS is malfunctioning. The front passenger front air bag will be deactivated in this case. Have the system checked by qualified technicians as soon as possible. Contact an authorized Mercedes-Benz Center.

Only have the seat repaired or replaced at an authorized Mercedes-Benz Center.

In order to ensure proper operation of the air bag system and OCS:

- Sit with the seat belt properly fastened in a position that is as upright as possible with your back against the seat backrest.
- When seated, a passenger should not position him/herself in such a way as to cause the passenger's weight to be lifted from the seat cushion as this may result in the OCS being unable to correctly approximate the passenger's weight category.
- Read and observe all warnings in this chapter.

System self-test

The  indicator lamp illuminates when you:

- turn the SmartKey to position **1** or **2** in the ignition lock
- press the Start/Stop button once or twice

If an adult occupant is properly sitting on the passenger seat and the OCS classifies the occupant as an adult, the  indicator lamp illuminates and goes out again after approximately 6 seconds.

If the seat is not occupied and the OCS classifies the front passenger seat as being unoccupied, the  indicator lamp will illuminate and not go out.

WARNING

If the  indicator lamp does not illuminate, the system is not functioning. You must contact an authorized Mercedes-Benz Center before seating any child on the passenger seat.

For more information, see "Problems with the Occupant Classification System" (▷ page 46).

WARNING



Never place anything between seat cushion and child seat (e.g. a pillow), since it reduces the effectiveness of the OCS. The underside and rear side child restraint system must be placed entirely on the seat cushion and the backrest of the front-passenger seat backrest.

If necessary, adjust the tilt of the passenger seat backrest.



An incorrectly mounted child seat could cause injuries to the child in case of an accident, instead of increasing protection for the child.





Follow the manufacturer's instructions for installation of child restraint systems.

Problems with the Occupant Classification System



Problem	Possible causes/consequences and ► Solutions
<p>The   indicator lamp illuminates and remains illuminated. The person on the front-passenger seat:</p> <ul style="list-style-type: none"> • has the weight of a typical adult • has been determined by the system not to be a child. 	<p>The OCS is malfunctioning.</p> <ul style="list-style-type: none"> ► Have the OCS checked as soon as possible at an authorized Mercedes-Benz Center. ► Observe the additional display messages in the multifunction display (▷ page 167).

WARNING

If the   indicator lamp illuminates and remains illuminated when the weight of a typical adult or someone larger than a small individual has been detected on the passenger seat, do not allow any occupant to use the passenger seat until the system has been repaired.

Problem	Possible causes/consequences and ► Solutions
<p>The   indicator lamp does not illuminate and/or does not remain illuminated. The front-passenger seat is:</p> <ul style="list-style-type: none"> • unoccupied • occupied with a weight up to or less than a typical 12-month-old child in a standard child restraint system 	<p>The OCS is malfunctioning.</p> <ul style="list-style-type: none"> ► Make sure there is nothing between the seat cushion and the child seat. ► Check the installation of the child restraint system. ► Make sure that no objects are applying additional weight onto the seat. ► If the   indicator lamp does not illuminate, have the OCS checked as soon as possible at an authorized Mercedes-Benz Center. Do not transport a child on the front-passenger seat as long as the OCS is not functioning. ► Observe the additional display messages in the multifunction display (▷ page 167).

WARNING

If the   indicator lamp does not illuminate or remains out with the weight of a typical 12-month-old child in a standard child restraint or less, or is unoccupied, on the front-passenger seat, do not transport a child on the front-passenger seat until the system has been repaired.

Exiting in an emergency (Coupe only)

If the vehicle is lying on its roof after an accident, the hinge fasteners of the gullwing doors are released pyrotechnically. You will hear a bang if this is the case. After the fasteners have been released, the doors are forced outwards. Simultaneously, the door locks are unlocked. The  SRS warning lamp lights up.

- i** The hinge fasteners are only released when the control unit recognizes that certain conditions have been fulfilled, e.g. when the vehicle is in a stabilized position on its roof.

The doors can then be moved from the inside/outside by pulling the door handle.

Seat belts

Important safety notes

The use of infant or child restraints is required by law in all 50 states, the District of Columbia, the U.S. territories and all Canadian provinces.

Even where this is not the case, all vehicle occupants should have their seat belts fastened when the vehicle is in motion.

- i** See "Children in the vehicle" (▷ page 51) for further information on infants and children traveling in the vehicle as well as on child restraint systems.

WARNING

Always fasten your seat belt before driving off. Always make sure your passenger is properly restrained. You and your passenger should always wear seat belts.

Failure to wear and properly fasten and position your seat belt considerably increases your risk of injuries and their likely severity in an accident.

If you are ever in an accident, your injuries could be considerably more severe if you have not fastened your seat belt correctly. If you do

not fasten your seat belt, you are much more likely to collide with parts of the vehicle interior or be ejected from it. This may result in serious or fatal injury.

In the same crash, the possibility of serious or fatal injury is considerably reduced if you wear your seat belt properly. The air bags can only offer the intended protection if the occupants are wearing their seat belts properly.

WARNING

Never ride in a moving vehicle with the seat backrest in an excessively reclined position as this can be dangerous. You could slide under the seat belt in a collision. If you slide under it, the seat belt would apply force at the abdomen or neck. That could cause serious or even fatal injuries. The seat backrest and seat belt provide the best restraint when the wearer is in a position that is as upright as possible and the seat belt is properly positioned on the body.

WARNING

Never let more people ride in the vehicle than there are seat belts available. Make sure everyone riding in the vehicle is correctly restrained with a separate seat belt. Never use a seat belt for more than one person at a time.

WARNING

Damaged seat belts or seat belts that have been subjected to stress in an accident must be replaced and their anchoring points must also be checked.

Only use seat belts which have been approved by Mercedes-Benz.

Do not make any modifications to the seat belts. This can lead to unintended activation of the ETDs or to their failure to activate when necessary.

Do not bleach or dye seat belts as this may severely weaken them. In a crash they may not be able to provide adequate protection.

Have all work carried out only by qualified technicians. Contact an authorized Mercedes-Benz Center.

Correct use of the seat belts

WARNING

USE SEAT BELTS PROPERLY

- Seat belts can only work when used properly. Never wear seat belts in any other way than as described in this section, as that could result in serious injuries in the event of an accident.
- Each occupant should wear their seat belt at all times, because seat belts help reduce the likelihood of and potential severity of injuries in accidents, including rollovers. The integrated restraint system includes SRS (driver front air bag, knee bags, front-passenger front air bag, side impact air bags, head air bags), Emergency Tensioning Devices (ETDs) and seat belt force limiters. The system is designed to enhance the protection offered to properly belted occupants in certain frontal (front air bags, knee bags and ETDs) and side (side impact air bags, head air bags and ETDs) impacts which exceed preset deployment thresholds.
- Never wear the shoulder belt under your arm, across your neck or off your shoulder. In a frontal crash, your body would move too far forward. That would increase the chance of head and neck injuries. The seat belt would also apply too much force to the ribs or abdomen, which could severely injure internal organs such as your liver or spleen.

Adjust the seat belt so that the shoulder section is located as close as possible to the middle of the shoulder (it should not touch the neck).

- Position the lap belt as low as possible on your hips and not across the abdomen. If the lap belt is positioned across your

abdomen, it could cause serious injuries in a crash.

- Never wear seat belts over rigid or breakable objects in or on your clothing, such as eyeglasses, pens, keys etc., as these might cause injuries.
- Make sure the seat belt is always fitted snugly. Take special care of this when wearing loose clothing.
- Never use a seat belt for more than one person at a time. Do not fasten a seat belt around a person and another person or other objects at the same time.
- Seat belts should not be worn twisted. In a crash, you would not have the full width of the seat belt to distribute impact forces. The twisted seat belt against your body could cause injuries.
- Pregnant women should also always use a lap-shoulder belt. The lap belt portion should be positioned as low as possible on the hips to avoid any possible pressure on the abdomen.
- Place the seat backrest in a position that is as upright as possible.
- Check your seat belt during travel to make sure it is properly positioned.
- Never place your feet on the instrument panel, dashboard, or on the seat. Always keep both feet on the floor in front of the seat.
- When using a seat belt to secure infant restraints, toddler restraints, or children in booster seats, always follow the child seat manufacturer's instructions.

WARNING

Do not pass seat belts over sharp edges. They could tear.

Do not allow the seat belt to get caught in the door or in the seat adjustment mechanism. This could damage the seat belt.

Never attempt to make modifications to seat belts. This could impair the effectiveness of the seat belts.

Fastening seat belts

WARNING

Children 12 years old and under must be seated and properly secured in an appropriately sized infant restraint, child restraint system, or booster seat recommended for the size and weight of the child. For additional information, see the "Children in the vehicle" section.

A child's risk of serious or fatal injuries is significantly increased if the child restraints are not properly secured in the vehicle and/or the child is not properly secured in the child restraint.

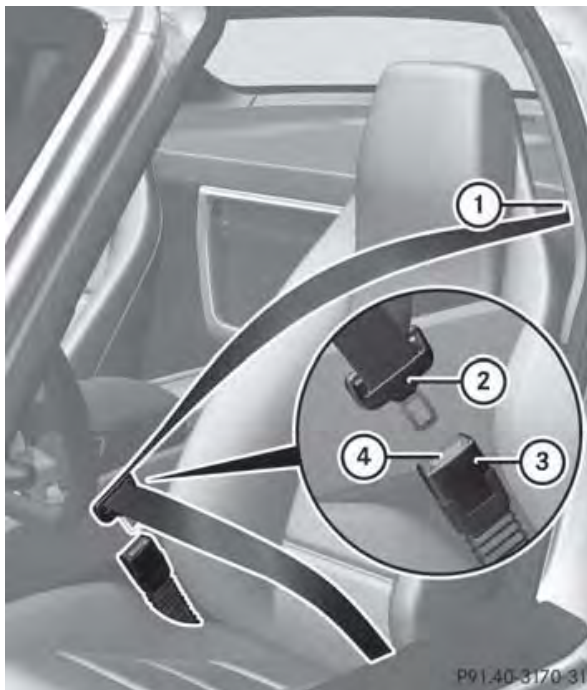

Example: Coupe

- ▶ Adjust the seat and move the backrest to an almost vertical position (▷ page 83).
- ▶ Pull the seat belt smoothly from belt sash guide ①.
- ▶ Without twisting it, guide the shoulder section of the seat belt across the middle of your shoulder and the lap section across your hips.

- ▶ Engage belt tongue ② in buckle ③.
- ▶ If necessary, pull upwards on the shoulder section of the seat belt to tighten the belt across your body.

The seat belt on the front-passenger side is equipped with a special seat belt retractor to secure child restraint systems properly on the front-passenger seat. For further information on special seat belt retractors, see (▷ page 53).

For more information about releasing the seat belt with release button ④, see "Releasing seat belts" (▷ page 49).

Releasing seat belts

- ▶ Press release button ④ (▷ page 49) and guide belt tongue ② (▷ page 49) back towards belt sash guide ① (▷ page 49).



! Make sure that the seat belt is fully rolled up. Otherwise, the seat belt or belt tongue will be trapped in the door or in the seat mechanism. This could damage the door, the door trim panel and the seat belt. Damaged seat belts can no longer fulfill their protective function and must be replaced. Consult an authorized Mercedes-Benz Center.

Belt warning for the driver and front passenger

Regardless of whether the driver's and front-passenger seat belts have already been fastened, the  seat belt warning lamp lights up for six seconds each time the engine is started. It then goes out once the driver and the front passenger have fastened their seat belts.

If the driver's seat belt is not fastened when the engine is started, an additional warning tone will sound. The warning tone switches off after approximately six seconds or once the driver's seat belt is fastened.

If after six seconds the driver or front passenger have not fastened their seat belts and the doors are closed:

- the  seat belt warning lamp remains lit as long as either the driver's or front-passenger's seat belt is not fastened
- and if a vehicle speed of 15 mph (25 km/h) is exceeded, the  seat belt warning lamp lights up and a warning tone also sounds with increasing intensity for a maximum of 60 seconds or until the driver or front-passenger seat belt has been fastened

If the driver or front-passenger seat belt is unfastened while the vehicle is in motion, the  seat belt warning lamp lights up and a warning tone sounds again.

The warning tone ceases even if the driver or front-passenger seat belt has still not been fastened after 60 seconds. The  seat belt warning lamp stops flashing but remains lit.

After the vehicle comes to a standstill, the warning tone is reactivated and the  seat belt warning lamp flashes again if the vehicle speed again exceeds 15 mph (25 km/h).

The  seat belt warning lamp only goes out if:

- both the driver and the front passenger have fastened their seat belts.

or

- the vehicle is stationary and a door is open.

i For more information on the  seat belt warning lamp, see "Warning and indicator lamps in the instrument cluster, seat belt" (> page 187).

Emergency Tensioning Devices and belt force limiters

The seat belts are equipped with Emergency Tensioning Devices and seat belt force limiter.

! If the front-passenger seat is not occupied, do not engage the seat belt tongue in the buckle on the front-

passenger seat. Otherwise, the Emergency Tensioning Device could be triggered in the event of an accident.

The ETDs tighten the seat belts in an accident, pulling them close against the body.

The ETDs do not correct incorrect seat positions or incorrectly fastened seat belts.

The ETDs do not pull vehicle occupants back towards the backrest.

When triggered, the seat belt force limiters help to reduce the peak force exerted by the seat belt on the vehicle occupant.

The seat belt force limiter are synchronized with the front air bags, which take on a part of the deceleration force. Thus, the force exerted on the occupant is distributed over a greater area.

When the ignition is switched on, the ETDs cannot be triggered unless:

- the restraint systems are operational; see "SRS warning lamp". (> page 36)
- the belt tongue is engaged in the buckle on each of the three-point seat belts.
- the front-passenger seat is occupied and the belt tongue is engaged in the buckle on the front-passenger side.

The ETDs are triggered depending on the type and severity of an accident:

- in the event of a head-on or rear-end collision, if the vehicle decelerates or accelerates rapidly in a longitudinal direction during the initial stages of the impact
- in the event of a side impact, if the vehicle is subjected to high lateral acceleration/ deceleration
- Coupe: in certain situations if the vehicle rolls over, and the system determines that it can provide additional protection
- Roadster: if the vehicle rolls over

If the Emergency Tensioning Devices (ETDs) are triggered, you will hear a bang, and a small amount of smoke may also be released. Only in rare cases will the bang affect your hearing.

The smoke that is released generally does not constitute a health hazard. The  SRS warning lamp lights up.

WARNING

Pyrotechnic ETDs that were activated must be replaced.

For your safety, when disposing of the pyrotechnic ETDs always follow our safety instructions. These are available at any authorized Mercedes-Benz Center.

Children in the vehicle

Important safety notes

WARNING

When leaving the vehicle, always remove the SmartKey from the ignition lock. Always take the SmartKey with you and lock the vehicle. Do not leave children unattended in the vehicle, even if they are secured in a child restraint system, or with access to an unlocked vehicle. A child's unsupervised access to a vehicle could result in an accident and/or serious personal injury. The children could:

- injure themselves on parts of the vehicle
- be seriously or fatally injured through excessive exposure to extreme heat or cold
- injure themselves or cause an accident with vehicle equipment that can be operated even if the SmartKey is removed from the ignition lock or removed from the vehicle, such as seat adjustment, steering wheel adjustment, or the memory function

If children open a door, they could injure other persons or get out of the vehicle and injure themselves or be injured by following traffic.

Do not expose the child restraint system to direct sunlight. The child restraint system's metal parts, for example, could become very hot, and the child could be burned on these parts.

WARNING

Do not carry heavy or hard objects in the passenger compartment unless they are firmly secured in place.

Unsecured or improperly positioned cargo increases a child's risk of injury in the event of:

- strong braking maneuvers
- sudden changes of direction
- an accident

If an infant or child is traveling in the vehicle:

- ▶ Secure the child with a child or infant seat restraint system appropriate to the age and weight of the child.
- ▶ Make sure that the infant or child is properly secured at all times while the vehicle is in motion.

Child restraint systems

Important safety notes

We recommend that all infants and children be properly restrained using the child restraint systems at all times while the vehicle is in motion.

The use of infant or child restraints is required by law in all 50 states, the District of Columbia, the U.S. territories and all Canadian provinces.

Infants and children must always be seated in an appropriate infant or child restraint system recommended for the size and weight of the child. They must be properly secured in accordance with the manufacturer's installation instructions for the infant or child seat restraint system. All infant or child restraint systems must comply with the U.S. Federal Motor Vehicle Safety Standards 213 and 225 and Canadian Motor Vehicle Safety Standards 213 and 210.2.

Confirmation that the child restraint system corresponds to the standards can be found on an instruction label on the child restraint

system. This confirmation can also be found in the installation instructions that are included with the child restraint system.

When using any infant restraint, child restraint or booster seat, make sure to carefully read and follow all manufacturer's instructions for installation and use.

Please read the warning labels affixed to the interior of the vehicle or to the infant restraint or child restraints.

WARNING

Children under 12 years must be secured correctly in a suitable infant or child restraint system or booster seat suitable for the size and weight of the child.



The infant or child restraint system must be correctly secured using the vehicle's seat belt in complete accordance with the child seat manufacturer's instructions.

Occupants, in particular children, must sit as upright as possible, fasten the seat belt correctly and use a suitable infant restraint system, child restraint system or booster seat suitable for the size and weight of the child.

Children can be killed or seriously injured by an inflating air bag. Please observe the following important information:

- your vehicle is equipped with air bag technology designed to deactivate the passenger front air bag in your vehicle when the system senses the weight of a typical 12-month-old child or less along with the weight of a standard appropriate child restraint on the passenger seat.
- a child in a rear-facing child restraint on the passenger seat will be seriously injured or even killed if the passenger front air bag inflates in a collision which could occur under some circumstances, even with the air bag technology installed in your vehicle.
- if you install a rearward-facing child restraint system on the front-passenger seat, make sure the  indicator lamp is illuminated, indicating that the front-passenger front air bag is disabled. If

the  indicator lamp does not light up or goes out when the child restraint system is installed, check the anchorages of the restraint system. Check the

 indicator lamp regularly while driving to ensure that the  indicator lamp is illuminated. If the

 indicator lamp goes out or remains out, you may only carry a child on the front-passenger seat once the system has been repaired.

a child in a rear-facing child restraint on the passenger seat will be seriously injured or even killed if the passenger front air bag inflates.

- when securing a child in a child restraint system on the front-passenger seat, you must:
 - move the front-passenger seat as far back as possible
 - use a child restraint system that is suitable for the age, size and weight of the child
 - observe the manufacturer's installation instructions in order to install and secure the child restraint system correctly.
- for children larger than the typical 12-month-old child, the passenger front air bag may or may not be activated.

WARNING

Infants and small children should never share a seat belt with another occupant. During an accident, they could be crushed between the occupant and seat belt.

A child's risk of serious or fatal injuries is significantly increased if the child restraints are not properly secured in the vehicle and/or the child is not properly secured in the child restraint.

Children too big for a toddler restraint must ride in seats using regular seat belts. Position the shoulder belt across the chest and shoulder, not face or neck. A booster seat may be necessary to achieve proper seat belt positioning for children over 41 lb (18 kg) until

they reach a height where a lap/shoulder belt fits properly without a booster.

When the child restraint is not in use, remove it from the vehicle or secure it with the seat belt to prevent the child restraint from becoming a projectile in the event of an accident.

Special seat belt retractor

The seat belt on the front-passenger seat is equipped with a special seat belt retractor. When enabled, the special seat belt retractor ensures that the seat belt does not slacken once the child seat is secured.

Installing a child restraint system:

- ▶ Always comply with the manufacturer's installation instructions.
- ▶ Pull the seat belt smoothly from the seat belt retractor.
- ▶ Engage the seat belt tongue in the belt buckle.

Activating the special seat belt retractor:

- ▶ Pull the seat belt out fully and let the seat belt retractor retract it again. While the seat belt is retracting, you should hear a ratcheting sound. The special seat belt retractor is activated.
- ▶ Push down on the child restraint system to take up any slack.

Removing a child restraint system/
deactivating the special seat belt retractor:

- ▶ Always comply with the manufacturer's installation instructions.
- ▶ Press the seat belt release button and guide the belt tongue to the belt outlet. The special seat belt retractor is deactivated.

WARNING

Never release the seat belt buckle while the vehicle is in motion, since the special seat belt retractor will be deactivated.

Installing child restraint systems

Observe the "Important safety notes" section (▷ page 51).

The Top Tether anchorage is installed behind the front-passenger seat.

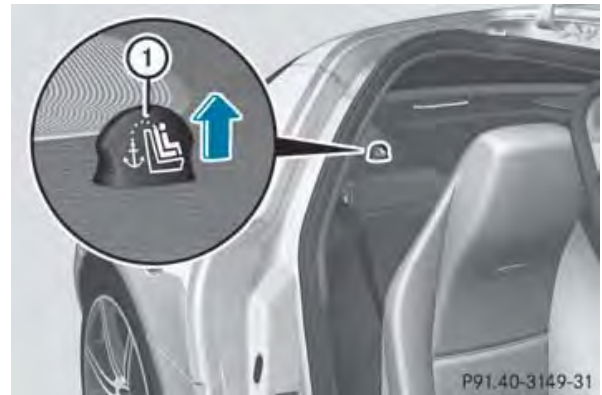

- ▶ Slide the front-passenger seat forward.
- ▶ Remove cover ① from the Top Tether anchorage in the direction of the arrow.

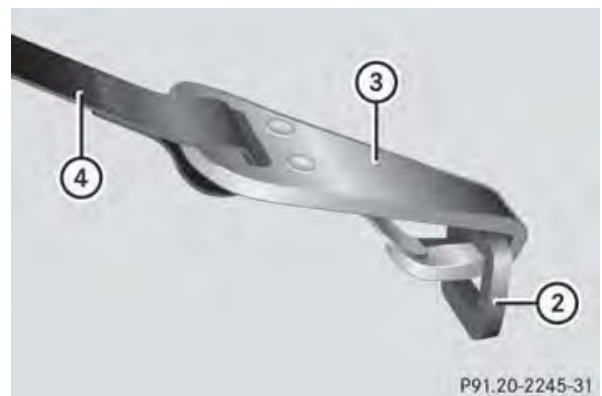

- ▶ Position Top Tether belt ④. Comply with the manufacturer's installation instructions when doing so.
- ▶ Hook Top Tether hook ③ into Top Tether anchorage ②.

Ensure that:

- Top Tether hook ③ is hooked into Top Tether anchorage ② as shown.
- Top Tether belt ④ is not twisted.

When Top Tether hook ③ is connected, the child restraint system can be secured.

- ▶ Install the child restraint system.
- ▶ Tension Top Tether belt ④. Comply with the manufacturer's installation instructions when doing so.

The child restraint system with Top Tether belt ④ has been removed:

- ▶ Slide cover ① onto Top Tether anchorage ②.

Panic alarm



- ▶ **To activate:** press **PANIC** button ① for approximately one second. An alarm sounds and the exterior lighting flashes.
 - ▶ **To deactivate:** press **PANIC** button ① again.
- or
- ▶ Insert the SmartKey into the ignition lock.
- or
- ▶ Press the Start/Stop button.
- The SmartKey must be in the vehicle.

i USA only:

This device complies with Part 15 of the FCC regulations. Operation is subject to the following two conditions:

1. This device may not cause harmful interference, and
2. this device must accept any interference received, including interference that may cause undesired operation of the device.

Any unauthorized modification to this device could void the user's authority to operate the equipment.

The Product label with FCC ID and IC certification number can be found in the battery case of the key.

i Canada only:

This device complies with RSS-Gen of Industry Canada. Operation is subject to the following two conditions:

1. This device may not cause harmful interference, and
2. this device must accept any interference received, including interference that may cause undesired operation of the device.

Any unauthorized modification to this device could void the user's authority to operate the equipment.

The Product label with FCC ID and IC certification number can be found in the battery case of the key.

Driving safety systems

Overview of driving safety systems

In this section, you will find information about the following driving safety systems:

- ABS (**A**nti-**l**ock **B**raking **S**ystem)
- BAS (**B**rake **A**ssist **S**ystem)
- ESP[®] (**E**lectronic **S**tability **P**rogram)
- EBD (**e**lectronic **b**rake **f**orce **d**istribution)
- ADAPTIVE BRAKE

Important safety notes

⚠ WARNING

The following factors increase the risk of accidents:

- Excessive speed, especially in turns
- Wet and slippery road surfaces
- Following another vehicle too closely

The driving safety systems described in this section cannot reduce these risks or prevent the natural laws of physics from acting on the vehicle. They cannot increase braking or steering efficiency beyond that afforded by the condition of the vehicle brakes and tires or the traction afforded.

Only a safe, attentive, and skillful driver can prevent accidents.

The capabilities of a vehicle equipped with the driving safety systems described in this section must never be exploited in a reckless or dangerous manner which could jeopardize the user's safety or the safety of others.

Always adjust your driving style to the prevailing road and weather conditions and keep a safe distance to other road users and objects on the street.

If a driving system malfunctions, other driving safety systems may also switch off. Observe indicator and warning lamps that may come on as well as messages in the multifunction display that may appear.

- i** In wintry driving conditions, always use winter tires (M+S tires) and if necessary, snow chains. Only in this way will the driving safety systems described in this section work as effectively as possible.

ABS (Anti-lock Braking System)

Important safety notes

WARNING

Do not pump the brake pedal. Use firm, steady brake pedal pressure instead. Pumping the brake pedal reduces the braking effect.

ABS regulates brake pressure in such a way that the wheels do not lock when you brake. This allows you to continue steering the vehicle when braking.

ABS works from a speed of about 5 mph (8 km/h) upwards, regardless of road-

surface conditions. ABS works on slippery surfaces, even if you only brake gently.

The  warning lamp in the instrument cluster lights up when the ignition is switched on. It goes out when the engine is running.

Braking

If ABS intervenes when braking, you will feel a pulsing in the brake pedal.

- ▶ **If ABS intervenes:** continue to depress the brake pedal vigorously until the braking situation is over.
- ▶ **To make a full brake application:** depress the brake pedal with full force.

WARNING

If the ABS malfunctions, other driving systems such as the BAS or the ESP[®] are also switched off. Observe indicator and warning lamps that may come on as well as messages in the multifunction display that may appear.

If the ABS malfunctions, the wheels may lock during hard braking, reducing the steering capability and extending the braking distance.

The pulsating brake pedal can be an indication of hazardous road conditions, and functions as a reminder to take extra care while driving.

BAS (Brake Assist System)

Observe the "Important safety notes" section (▶ page 56).

BAS operates in emergency braking situations. If you depress the brake pedal quickly, BAS automatically boosts the braking force, thus shortening the stopping distance.

- ▶ Keep the brake pedal firmly depressed until the emergency braking situation is over. ABS prevents the wheels from locking.

The brakes will function as usual once you release the brake pedal. BAS is deactivated.

⚠ WARNING

If the BAS malfunctions, the brake system still functions, but without the additional brake boost available that the BAS would normally provide in an emergency braking maneuver. Therefore, the braking distance may increase.

ESP® (Electronic Stability Program)**General notes**

i Observe the "Important safety notes" section (▷ page 56).

ESP® monitors driving stability and traction, i.e. power transmission between the tires and the road surface.

If ESP® detects that the vehicle is deviating from the direction desired by the driver, one or more wheels are braked to stabilize the vehicle. The engine output is also modified to keep the vehicle on the desired course within physical limits. ESP® assists the driver when pulling away on wet or slippery roads. ESP® can also stabilize the vehicle during braking.

ETS (Electronic Traction System)

i Observe the "Important safety notes" section (▷ page 56).

Traction control is part of ESP®.

Traction control brakes the drive wheels individually if they spin. This enables you to pull away and accelerate on slippery surfaces, for example if the road surface is slippery on one side.

Traction control remains active, even if you deactivate ESP®.

Important safety notes**⚠ WARNING**

If ESP® is malfunctioning, ESP® is unable to stabilize the vehicle. Additionally, further driving safety systems are deactivated. This increases the risk of skidding and an accident.

Drive on carefully. Have ESP® checked at a qualified specialist workshop.

! Switch the ignition off when:

- the electric parking brake is being tested using a brake dynamometer.
- the vehicle is being towed with the rear axle raised.

Application of the brakes by ESP® may otherwise destroy the brake system.

When SPORT handling mode is activated, the **SPORT** warning lamp lights up in the instrument panel.

When ESP® is deactivated, the **OFF** and **ESP** warning lamps light up in the instrument panel.

Observe the information on warning lamps (▷ page 190) and display messages which may be shown in the instrument cluster (▷ page 166).

i Only use wheels with the recommended tire sizes. Only then will ESP® function properly.

Characteristics of ESP®

ESP® is activated automatically when the engine is started.

If ESP® intervenes, the **ESP** warning lamp flashes in the instrument cluster.

If ESP® intervenes:

- ▶ Do not deactivate ESP® under any circumstances.
- ▶ Only depress the accelerator pedal as far as necessary when pulling away.
- ▶ Adapt your driving style to suit the prevailing road and weather conditions.

Deactivating/activating ESP®**Important safety notes**

i Observe the "Important safety notes" section (▷ page 54).

You can select between the following states of ESP®:

- ESP® is activated.
- SPORT handling mode is activated.
- ESP® is deactivated.

WARNING

When SPORT handling mode is activated, there is a greater risk of skidding and accidents.

Only activate SPORT handling mode in the situations described in the following.

WARNING

If you deactivate ESP®, ESP® no longer stabilizes the vehicle. There is an increased risk of skidding and an accident.

Only deactivate ESP® in the situations described in the following.

In the following situations, it may be better to activate SPORT handling mode or deactivate ESP®:

- when using snow chains
- in deep snow
- on sand or gravel
- when driving on designated roads when the vehicle's own oversteering and understeering characteristics are desired

Driving in SPORT handling mode or without ESP® requires an extremely qualified and experienced driver.

- i** Activate ESP® as soon as the situations described above no longer apply. ESP® will otherwise not be able to stabilize the vehicle if the vehicle starts to skid or a wheel starts to spin.

- !** Avoid spinning the driven wheels for an extended period with ESP® deactivated. You could otherwise damage the drivetrain.

Deactivating/activating ESP®



► To activate SPORT handling mode:

briefly press button ①.



The **SPORT** warning lamp in the instrument cluster lights up. The **SPORT handling mode** message appears in the multifunction display.

► To deactivate SPORT handling mode:

briefly press button ①.



The **SPORT** warning lamp in the instrument cluster goes out. ESP® is activated.

► To deactivate ESP®: press and hold down

button ① until the  and  warning lamps in the instrument panel light up.

The **OFF** message appears in the multifunction display.

► To activate ESP®: when SPORT handling mode is activated or ESP® is deactivated, press button ① briefly.

The  and  warning lamps in the instrument cluster go out. The **ON** message appears in the multifunction display.

Characteristics of activated SPORT handling mode

SPORT handling mode raises the intervention threshold for stabilizing the vehicle. This allows for a sportier driving style on designated race circuits and may in certain situations improve the traction in comparison with ESP®.

If SPORT handling mode is activated and one or more wheels start to spin, the  warning lamp in the instrument cluster

flashes. ESP® only stabilizes the vehicle to a limited degree.

When SPORT handling mode is activated:

- ESP® only improves driving stability to a limited degree.
- traction control is still activated.
- ESP® still provides support when you brake firmly.
- engine torque is only restricted to a limited degree, and the drive wheels are able to spin. The spinning wheels produce a cutting effect for better traction.

Characteristics when ESP® is deactivated

If ESP® is deactivated and one or more wheels start to spin, the  warning lamp in the instrument cluster does not flash. In such situations, ESP® will not stabilize the vehicle.

If you deactivate ESP®:

- ESP® no longer improves driving stability.
- traction control is still activated.
- ESP® still provides support when you brake firmly.
- engine torque is no longer limited and the drive wheels are able to spin. The spinning wheels produce a cutting effect for better traction.

EBD (electronic brake force distribution)

Observe the "Important safety notes" section (▷ page 56).

EBD monitors and controls the brake pressure on the rear wheels to improve driving stability while braking.

WARNING

If the EBD malfunctions, the brake system will still function with full brake boost. However, the rear wheels could lock up during emergency braking situations, for example. You could lose control of the vehicle and cause an accident.

Adapt your driving style to the changed driving characteristics.

ADAPTIVE BRAKE

Observe the "Important safety notes" section (▷ page 54).

ADAPTIVE BRAKE enhances braking safety and offers increased braking comfort. In addition to the braking function, ADAPTIVE BRAKE also features the hill start assist function (▷ page 115). For further information, see Driving tips (▷ page 131).

Theft deterrent locking system

Immobilizer

The immobilizer prevents your vehicle from being started without the correct SmartKey. When leaving the vehicle, always take the SmartKey with you and lock the vehicle. The engine can be started by anyone with a valid SmartKey that is left inside the vehicle.

- ▶ **To activate with KEYLESS-GO:** switch the engine off and open the driver's door.
- ▶ **To activate with the SmartKey:** remove the SmartKey from the ignition lock.
- ▶ **To deactivate:** switch on the ignition.

 The immobilizer is always deactivated when you start the engine.

In the event that the engine cannot be started when the starter battery is fully charged, the immobilizer may be faulty. Contact an authorized Mercedes-Benz Center or call 1-800-FOR-MERCEdes (in the USA) or 1-800-387-0100 (in Canada).

ATA (anti-theft alarm system)

A visual and audible alarm is triggered if the alarm system is armed and you open:

- a door
- the trunk lid

- the hood
- Roadster: the glove box
- Roadster: a compartment in the center console
- the vehicle with the mechanical key

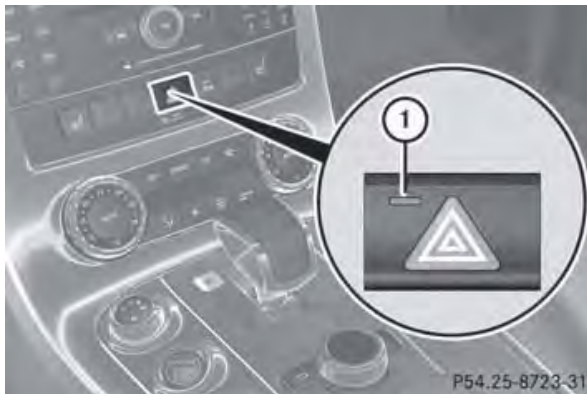

The alarm is not switched off, even if you close the open door that triggered it, for example.

- i** If the alarm stays on for more than 30 seconds, the mbrace emergency call system¹ automatically initiates a call to the Customer Assistance center. The mbrace emergency call system initiates the call if:
 - you have subscribed to the mbrace service
 - the mbrace service has been activated properly
 - the required mobile phone, power supply and GPS are available.



- To arm:** lock the vehicle with the SmartKey.
 The turn signal lamps flash three times and an acoustic warning sounds three times to indicate that the vehicle is locked. Flashing indicator lamp ① indicates that the alarm system is armed.
- i** If the turn signal lamps do not flash three times and the warning tone does not sound three times, a door or the trunk lid may not be properly closed.

It may be necessary to close the affected door or trunk lid.

- To disarm:** unlock the vehicle with the SmartKey.
 The turn signal lamps flash once and a warning tone sounds once, indicating that the alarm system is disarmed.
 - i** Unless you open a door or the trunk within approximately 40 seconds after unlocking:
 - the vehicle will be locked again
 - the alarm system will be rearmed
 - To stop the alarm:** press the Start/Stop button in the center console. The SmartKey must be inside the vehicle.
- or
- Press the  or  button on the SmartKey.
- or
- Insert the SmartKey into the ignition lock. The alarm is switched off.

Tow-away alarm

An audible and visual alarm is triggered if your vehicle's angle of inclination is altered while the tow-away alarm is armed. This occurs if the vehicle is jacked up on one side, for example.

- i** If the alarm stays on for more than 30 seconds, the mbrace² system initiates a call to the Customer Assistance Center automatically. The emergency call system initiates the call provided that:
 - you have subscribed to the mbrace service
 - the mbrace service has been activated properly
 - the required mobile phone, power supply and GPS are available.

¹ The system is called Tele Aid in Canada.

² TELEAID in Canada.

- ▶ **To arm:** lock the vehicle with the SmartKey.
The tow-away alarm is armed after approximately 30 seconds.
- ▶ **To deactivate:** unlock the vehicle with the SmartKey.
The tow-away alarm is deactivated automatically.

To prevent a false alarm, deactivate the tow-away alarm manually if your vehicle:

- is being transported
 - is being loaded onto a ferry or car transporter, for example
 - is parked on a movable surface, e.g. in a split-level garage
- ▶ **To deactivate:** use the Start/Stop button to set SmartKey position **0**.

or

- ▶ Remove the SmartKey from the ignition lock.

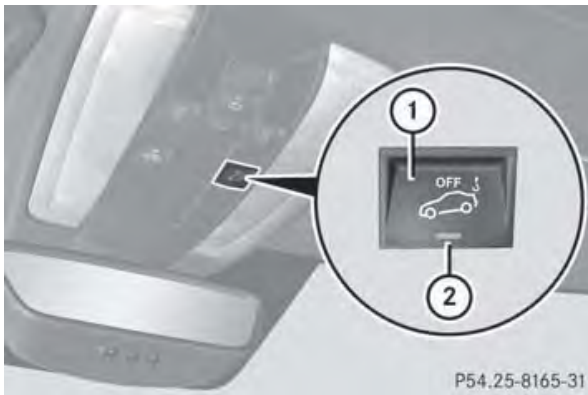

- ▶ Press button ①.
Indicator lamp ② lights up briefly.
- ▶ Lock the vehicle with the SmartKey.
The tow-away alarm is deactivated.
The tow-away alarm remains deactivated until the vehicle is unlocked and locked again.

Useful information	62
SmartKey	62
Doors	67
Trunk	71
Side windows	73
Soft top (Roadster)	76

Useful information

- i** This Operator's Manual describes all models and all standard and optional equipment of your vehicle available at the time of publication of the Operator's Manual. Country-specific differences are possible. Please note that your vehicle may not be equipped with all features described. This also applies to safety-related systems and functions.
- i** Please read the information on qualified specialist workshops (▷ page 22).

SmartKey

Key function

General notes

- i** USA only:
This device complies with Part 15 of the FCC Rules. Operation is subject to the following two conditions:
 1. This device may not cause harmful interference, and
 2. this device must accept any interference received, including interference that may cause undesired operation of the device.
 Any unauthorized modification to this device could void the user's authority to operate the equipment.
The Product label with FCC ID and IC certification number can be found in the battery case of the SmartKey.
- i** Canada only:
This device complies with RSS-210 of Industry Canada. Operation is subject to the following two conditions:
 1. This device may not cause harmful interference, and
 2. this device must accept any interference received, including interference that may cause undesired operation of the device.

Any unauthorized modification to this device could void the user's authority to operate the equipment.

The Product label with FCC ID and IC certification number can be found in the battery case of the SmartKey.

Locking/unlocking centrally

The SmartKey centrally locks/unlocks:

- the doors
- the trunk lid
- the fuel filler flap
- Roadster only: the glove box
- Roadster only: the stowage compartment under the armrest



⚠ WARNING

If children are left unsupervised in the vehicle, they could:

- open a door locked from inside the vehicle
- start the vehicle using a key which has been left in the vehicle
- release the parking brake

They could thereby endanger themselves and others. Never leave children unsupervised in the vehicle. Always take the key with you when leaving the vehicle, even if you are only leaving it for a short time.



- ①  To lock the vehicle
- ②  To unlock the trunk lid
- ③  To unlock the vehicle

The turn signals flash once when unlocking and three times when locking.

When it is dark, the surround lighting also comes on if it is activated in the on-board computer (▷ page 155).

You can also set an audible signal to confirm that the vehicle has been locked or unlocked. The audible signal can be activated and deactivated using the on-board computer (▷ page 156).



- ▶ **To unlock centrally:** press the  button.

If you do not open the vehicle within approximately 40 seconds of unlocking:



- the vehicle is locked again.
 - the anti-theft alarm system is armed again.
- ▶ **To lock centrally:** press the  button.

Changing the settings of the locking system



You can change the setting of the locking system in such a way that only the driver's door and the fuel filler flap are unlocked. This is useful if you frequently travel on your own.

- ▶ **To change the setting:** press and hold down the  and  buttons simultaneously for approximately six seconds until the battery check lamp (▷ page 64) flashes twice.

The SmartKey now functions as follows:

- ▶ **To unlock the driver's door:** press the  button once.
- ▶ **To unlock centrally:** press the  button twice.
- ▶ **To lock centrally:** press the  button.

Restoring the factory settings

- ▶ Press the  and  buttons simultaneously for approximately six seconds until the battery check lamp flashes twice.



Mechanical key

General notes

If the vehicle can no longer be locked or unlocked with the SmartKey, use the mechanical key.

If you use the mechanical key to unlock and open the driver's door, the anti-theft alarm system will be triggered (▷ page 58).

There are several ways to turn off the alarm:

- ▶ Press the  or  button on the SmartKey.

or

- ▶ Insert the SmartKey into the ignition lock.
- ▶ **To unlock the fuel filler flap:** insert the SmartKey into the ignition lock.

Removing the mechanical key



- ▶ Push release catch ① in the direction of the arrow and at the same time remove mechanical key ② from the SmartKey.

SmartKey battery

Important safety notes

Have the batteries changed at a qualified specialist workshop.

WARNING

Batteries contain toxic substances.

Swallowing batteries can lead to serious health issues or death.



Keep batteries out of the reach of children. Seek medical attention immediately if a battery is swallowed.

WARNING

The SmartKey batteries contain perchlorate material, which may require special handling and regard for the environment. Observe government disposal guidelines. California residents, see www.dtsc.ca.gov/HazardousWaste/Perchlorate/index.cfm.



Checking the battery



- ▶ Press the  or  button. The SmartKey battery is working properly if battery check lamp ① lights up briefly.

If battery check lamp ① does not light up briefly during the test, the SmartKey battery is discharged.

- ▶ Changing the battery (▶ page 64)

- i** The battery can be obtained from any authorized Mercedes-Benz Center.
- i** If the SmartKey battery is checked within the signal range of the vehicle, pressing the  or  button locks or unlocks the vehicle.

Replacing the battery

- ▶ Take the mechanical key out of the SmartKey (▶ page 63).

You require a CR 2025 3 V cell battery.

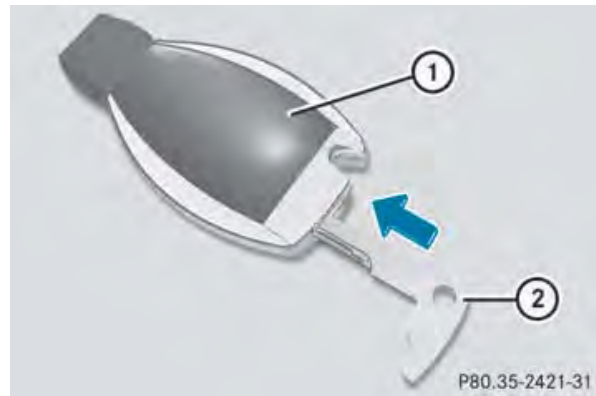

- ▶ Press mechanical key ② into the opening in the SmartKey in the direction of the arrow until battery tray cover ① opens. Do not hold the cover closed while doing so.

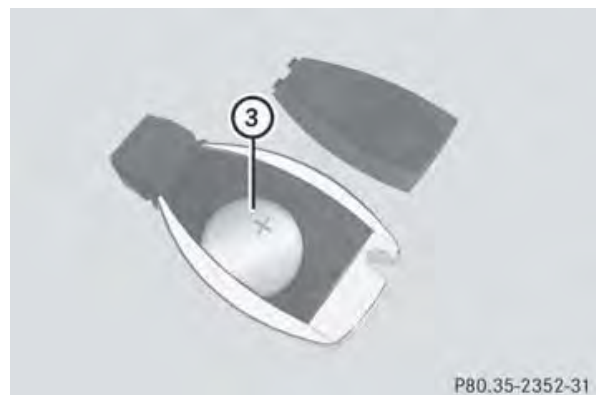

- ▶ Remove the cover of the battery tray.
- ▶ Repeatedly tap the SmartKey against your palm until battery ③ falls out.
- ▶ Insert the new battery with the positive terminal facing upwards. Use a lint-free cloth to do so.
- ▶ Insert the front tabs of the battery tray's cover first, and then press to close it.
- ▶ Check the function of all SmartKey buttons on the vehicle.

Problems with the SmartKey

Problem	Possible causes/consequences and ► Solutions
You cannot lock or unlock the vehicle using the SmartKey.	<p>The SmartKey battery is discharged or nearly discharged.</p> <ul style="list-style-type: none"> ► Point the tip of the SmartKey at the driver's door handle from close range and try to unlock or lock the vehicle again. <p>If this does not work:</p> <ul style="list-style-type: none"> ► Unlock the vehicle using the mechanical key (▷ page 63). ► Check the SmartKey battery and replace it if necessary (▷ page 64). <p>The SmartKey is faulty.</p> <ul style="list-style-type: none"> ► Lock or unlock the vehicle using the mechanical key (▷ page 63). ► Have the SmartKey checked at a qualified specialist workshop.
You have lost a SmartKey.	<ul style="list-style-type: none"> ► Have the SmartKey canceled at an authorized Mercedes-Benz Center. ► Report the loss immediately to the vehicle insurers. ► If necessary, have the locks changed as well.
You have lost the mechanical key.	<ul style="list-style-type: none"> ► Report the loss immediately to the vehicle insurers. ► If necessary, have the locks changed as well.
The engine cannot be started using KEYLESS-GO. The SmartKey is in the vehicle.	<p>A door is open. Therefore, the SmartKey cannot be detected as easily.</p> <ul style="list-style-type: none"> ► Close the door and try to start the vehicle again. <p>There is interference from a powerful source of radio waves.</p> <ul style="list-style-type: none"> ► Start your vehicle with the SmartKey in the ignition lock.

Problem	Possible causes/consequences and ► Solutions
<p>The engine cannot be started using the SmartKey.</p>	<p>The on-board voltage is too low.</p> <ul style="list-style-type: none"> ► Switch off non-essential consumers, such as seat heating or interior lighting, and try to start the engine again. ► Remove the SmartKey and reinsert it into the ignition lock. ► Start the engine within 30 seconds of inserting the SmartKey into the ignition lock. ► Repeat if necessary. <p>If this does not work:</p> <ul style="list-style-type: none"> ► Check the starter battery and charge it if necessary (▷ page 236). <p>or</p> <ul style="list-style-type: none"> ► Jump-start the vehicle (▷ page 240). <p>or</p> <ul style="list-style-type: none"> ► Consult a qualified specialist workshop.
<p>The SmartKey cannot be turned in the ignition lock.</p>	<p>The SmartKey has been in position 0 for a considerable time.</p> <ul style="list-style-type: none"> ► Remove the SmartKey and reinsert it into the ignition lock. ► Check the starter battery and charge it if necessary (▷ page 236). ► Start the engine. <hr/> <p>The on-board voltage is too low.</p> <ul style="list-style-type: none"> ► Switch off nonessential consumers, such as seat heating or interior lighting, and try to turn the SmartKey again. <p>If this does not work:</p> <ul style="list-style-type: none"> ► Check the starter battery and charge it if necessary (▷ page 236). <p>or</p> <ul style="list-style-type: none"> ► Jump-start the vehicle (▷ page 240). <p>or</p> <ul style="list-style-type: none"> ► Consult a qualified specialist workshop.

Doors

Important safety notes

WARNING

When leaving the vehicle, always remove the SmartKey from the ignition lock. Always take the SmartKey with you and lock the vehicle. Do not leave children unsupervised in the vehicle, even if they are secured in a child restraint system, and do not give them access to an unlocked vehicle. A child's unsupervised access to a vehicle could result in an accident and/or serious personal injury. They could:

- injure themselves on vehicle parts
- be seriously or fatally injured by extreme heat or cold
- injure themselves or have an accident with vehicle equipment that may still be in operation even after the SmartKey has been removed from the ignition, such as the seat adjustment, steering wheel adjustment or memory function.

If children open a door, they could cause severe or even fatal injury to other persons; if they get out of the vehicle, they could injure themselves when doing so or be seriously or even fatally injured by any passing traffic.

Do not expose the child restraint system to direct sunlight. The child restraint system's metal parts, for example, could become very hot, and a child could be burned on these parts.

WARNING

Do not carry heavy or hard objects in the passenger compartment or trunk unless they are firmly secured in place.

Unsecured or improperly positioned cargo increases a child's risk of injury in the event of

- strong braking maneuvers
- sudden changes of direction
- an accident

Unlocking and opening the doors from the outside

Coupe

- ❗ The doors swing upwards and out when opened. Therefore, make sure that there is sufficient clearance above the vehicle.

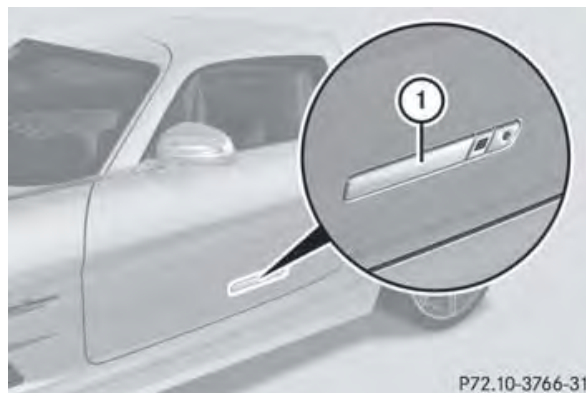

- ▶ **To open the door:** point the SmartKey towards door handle ①.
- ▶ Press the  button on the SmartKey. Door handle ① moves out.
- ▶ Lift the door by door handle ① and swing it up as far as it will go.
- ▶ **To close the door:** pull the door downwards by the outer edge or the interior door handle. Swing the door down gently and allow it to engage in the lower position.
- ▶ Lock the vehicle with the SmartKey if necessary (▷ page 62).

Roadster

- ▶ **To open the door:** point the SmartKey towards door handle.
- ▶ Press the  button on the SmartKey. The door is unlocked and can be opened.
- ▶ Pull the door handle.

Unlocking and opening doors from the inside

Coupe

You can only open a door from the inside if it is unlocked.

The vehicle locks the doors automatically, when you drive faster than 9 mph (15 km/h).

The doors are automatically unlocked after a journey if you switch off the engine.

! The doors swing upwards and out when opened. Therefore, make sure that there is sufficient clearance above the vehicle.

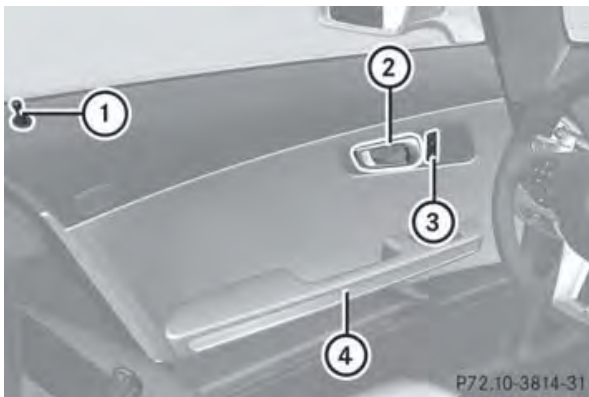

► **To unlock the door manually:** press the  button of central locking (3).

or

► Pull locking knob (1) upwards.

► **To open the door:** pull handle (2).

► Swing the door upwards as far as it will go.

► **To close the door:** pull the door down by handle (4).

► Allow the door to engage in the lower position.

► **To lock the door manually:** press the  button of central locking (3).

or

► Push locking knob (1) downwards.

Roadster

You can open a door from inside the vehicle even if it has been locked.

Only open the door when the traffic situation permits.



► Pull door handle (2).

If the door is locked, locking knob (1) pops up. The door is unlocked and can be opened.

i When a door is opened, the side window on that side opens slightly. When the door is closed, the triangular window closes again.

! The side windows will not open/close if the battery is discharged or if the side windows have iced up. It will then not be possible to close the door. Do not attempt to force the door closed. You could otherwise damage the door or the side window.

Centrally locking and unlocking the vehicle from the inside

You can centrally lock or unlock the vehicle from the inside. This feature may be useful if, for example, you wish to unlock the front-passenger door from the inside or lock the vehicle before you pull away.

Coupe: the central locking/unlocking button does not lock or unlock the fuel filler flap.

Roadster: the central locking/unlocking button does not lock or unlock the fuel filler flap or the stowage compartments, such as the glove box.

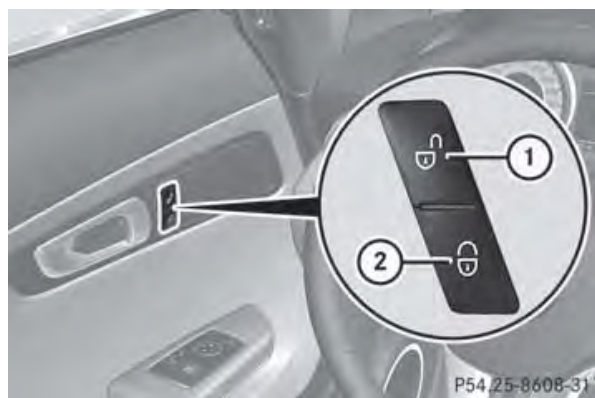

► **To lock:** press button ②.

If both doors are closed, the vehicle locks.

► **To unlock:** press button ①.

You can open a door from inside the vehicle even if it has been locked. Only open the door when the traffic situation permits.

If the vehicle has been locked with the central locking button:

- and the SmartKey is set to its factory setting, the entire vehicle is unlocked if a door is opened from the inside
- and the SmartKey is set to an individual setting, only the door that is opened from inside the vehicle is unlocked.

Automatic locking feature

Coupe

You can only open a door from the inside if it is unlocked.

The vehicle locks the doors automatically, when you drive faster than 9 mph (15 km/h).

The doors are automatically unlocked after a journey if you switch off the engine.

Roadster

The vehicle locks automatically when the ignition is switched on and the wheels of the vehicle are moving at a speed of more than 9 mph (15 km/h). There is therefore a risk of being locked out when the vehicle is being pushed, towed or tested on a dynamometer.

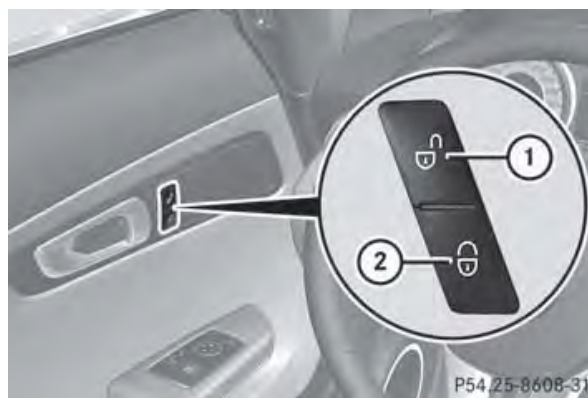

► **To deactivate:** press and hold button ① for about five seconds until a tone sounds.

► **To activate:** press and hold button ② for about five seconds until a tone sounds.

i If you press one of the two buttons and do not hear a tone, the relevant setting has already been selected.

You can also switch the automatic locking function on and off using the on-board computer (▷ page 155).

Unlocking the driver's door (mechanical key)

If the vehicle can no longer be unlocked with the SmartKey, use the mechanical key.

If you use the mechanical key to unlock and open the driver's door, the anti-theft alarm system will be triggered (▷ page 58).

- Take the mechanical key out of the SmartKey (▷ page 63).
- Insert the mechanical key into the lock of the driver's door as far as it will go.

Coupe

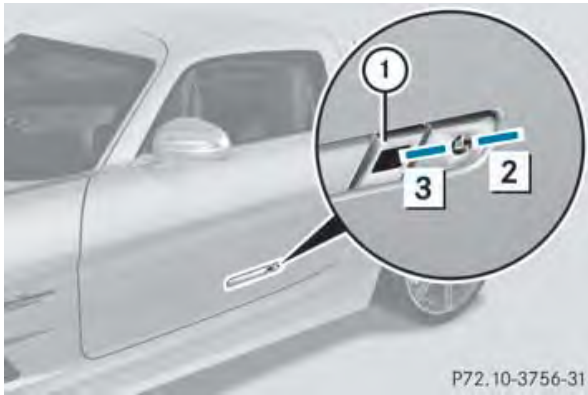

- ▶ **To unlock:** insert the mechanical key into the lock of the driver's door as far as it will go.
- ▶ Turn the mechanical key clockwise to position **2**.
The door is unlocked.
- ▶ Turn the mechanical key back and remove it.
- ▶ **To open the door:** press button **1**.
The handle moves out slightly from the door.
- ▶ Pull the handle out as far as it will go.
- ▶ Swing the door upwards by the handle.

Roadster

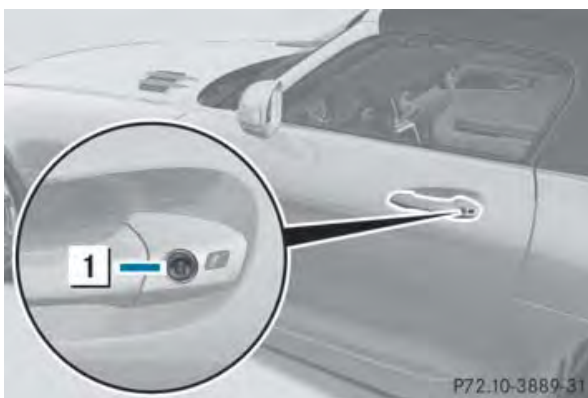

- ▶ Turn the mechanical key counter-clockwise to position **1**.
The door is unlocked.
- ▶ Turn the mechanical key back and remove it.
- ▶ Insert the mechanical key into the SmartKey.

Locking the vehicle (mechanical key)

If the vehicle can no longer be locked with the SmartKey, use the mechanical key.

Coupe

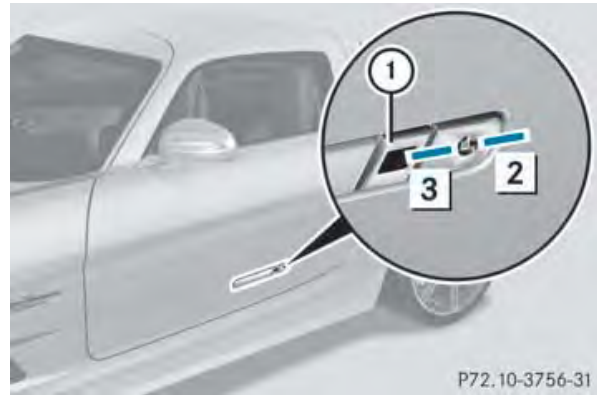

- ① Button for extending the handle
- ▶ **To lock:** lock the front-passenger door manually from the inside (▷ page 68).
- ▶ Leave the vehicle and close the driver's door.
- ▶ Insert the mechanical key into the lock of the driver's door as far as it will go.
- ▶ Turn the mechanical key counter-clockwise to position **3**.
The door is locked.
- ▶ Turn the mechanical key back and remove it.
- ▶ Check that both doors are locked.
- ⓘ If you lock the vehicle as described above, the fuel filler flap is not locked. The anti-theft alarm system is not armed.

Roadster

- ▶ Open the driver's door.
- ▶ Close the front-passenger door and the trunk lid.
- ▶ Press the locking button (▷ page 68).
- ▶ Check that the locking knob is in the lower position on the front-passenger door. Press the locking knob down by hand, if necessary.
- ▶ Close the driver's door.

- ▶ Take the mechanical key out of the SmartKey (▷ page 63).
- ▶ Insert the mechanical key into the lock of the driver's door as far as it will go.

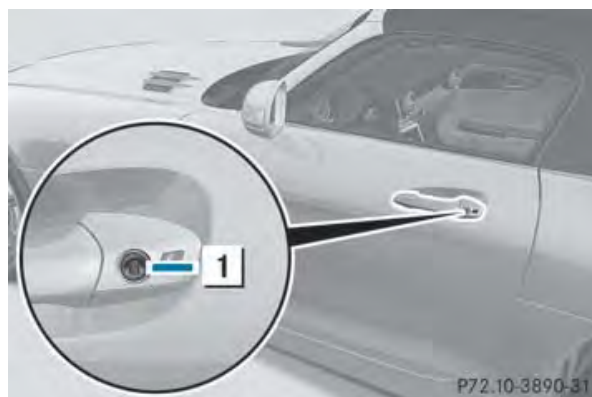

- ① Button for extending the handle
 - ▶ Turn the mechanical key clockwise as far as it will go to position **1**.
 - ▶ Turn the mechanical key back and remove it.
 - ▶ Make sure that the doors and the trunk lid are locked.
 - ▶ Insert the mechanical key into the SmartKey.
- i** If you lock the vehicle as described above, the fuel filler flap is not locked. The anti-theft alarm system is not armed.

Trunk

Important safety notes

WARNING

When leaving the vehicle, always remove the SmartKey from the ignition lock. Always take the SmartKey with you and lock the vehicle. Do not leave children unsupervised in the vehicle, even if they are secured in a child restraint system, and do not give them access to an unlocked vehicle. A child's unsupervised access to a vehicle could result in an accident and/or serious personal injury. They could:

- injure themselves on vehicle parts
- be seriously or fatally injured by extreme heat or cold
- injure themselves or have an accident with vehicle equipment that may still be in operation even after the SmartKey has been removed from the ignition, such as the seat adjustment, steering wheel adjustment or memory function.

If children open a door, they could cause severe or even fatal injury to other persons; if they get out of the vehicle, they could injure themselves when doing so or be seriously or even fatally injured by any passing traffic. Do not expose the child restraint system to direct sunlight. The child restraint system's metal parts, for example, could become very hot, and a child could be burned on these parts.

WARNING

Make sure the trunk lid is closed when the engine is running and while driving. Among other dangers, deadly carbon monoxide (CO) gases may enter the vehicle interior resulting in unconsciousness and death.

- !** The temperature in the trunk may be high. For this reason, do not store any temperature-sensitive objects in the trunk.

! The trunk lid swings upwards when opened. Therefore, make sure that there is sufficient clearance above the trunk lid.

Coupe: to fully open the trunk lid, a minimum height of 5.5 ft (1.68 m) from the ground is necessary.

Roadster: to fully open the trunk lid, a minimum height of 5.7 ft (1.75 m) from the ground is necessary.

The trunk lid can be:

- opened automatically from outside
- opened automatically from inside
- locked separately
- unlocked with the mechanical key
- opened with the emergency release button

Opening/closing the trunk

Opening/closing from outside

Opening

- ▶ Press the  button on the SmartKey. The trunk lid opens slightly.



- ▶ Reach into the gap and pull up the trunk lid.

Closing

WARNING

To prevent possible personal injury, always keep hands and fingers away from the trunk opening when closing the trunk lid. Be especially careful when small children are around.



- ▶ Push the trunk lid down until it engages. Use handle ① to pull down the trunk lid if necessary.
- ▶ If necessary, lock the vehicle with the  button on the SmartKey.

Opening the trunk from inside the vehicle

You can open the tailgate from the driver's seat when the vehicle is stationary.



- ▶ Press trunk lid remote control button ①. The trunk lid opens slightly.

Locking the trunk separately

You can lock the trunk separately. If you then unlock the vehicle centrally, the trunk remains locked and cannot be opened.

- ▶ Close the trunk lid.
- ▶ Take the mechanical key out of the SmartKey (▷ page 63).

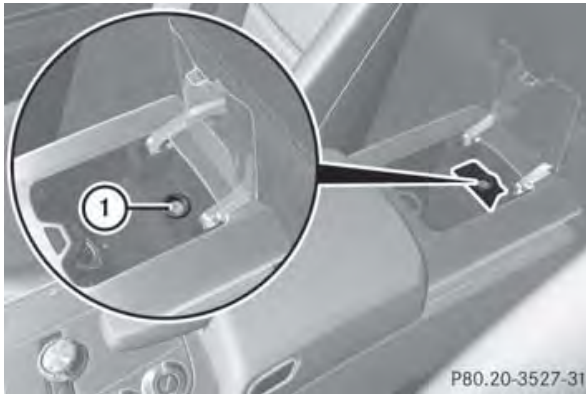

P80.20-3527-31

- ▶ Insert the mechanical key fully into trunk lid lock ① in the rear compartment of the center console.
- ▶ Turn the mechanical key clockwise as far as possible.
- ▶ Remove the mechanical key.
- ▶ Check that the trunk remains locked when you press on the trunk lid remote control button.

Unlocking the trunk (mechanical key)

If the trunk can no longer be unlocked with the SmartKey:

- ▶ Take the mechanical key out of the SmartKey (▶ page 63).

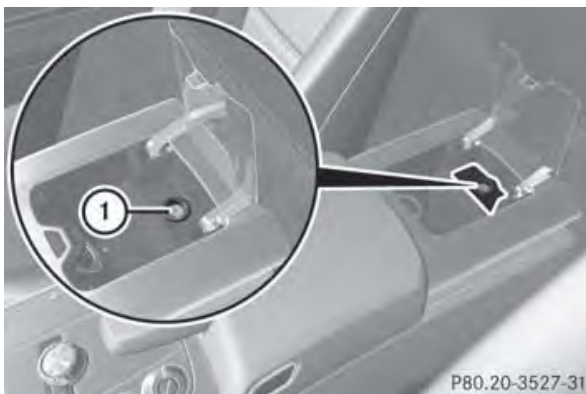

P80.20-3527-31

- ▶ Insert the mechanical key fully into trunk lid lock ① in the center console in the vehicle interior.
- ▶ Turn the mechanical key counter-clockwise as far as possible.
The trunk lid opens slightly.

Trunk emergency release

You can open the trunk lid from inside the vehicle with the emergency release button.



P88.50-2997-31

- ▶ Briefly press emergency release button ①.
The trunk lid unlocks and opens slightly.
- ▶ Push the trunk lid upwards to open it completely.

The trunk lid can be unlocked with the trunk lid emergency release when the vehicle is stationary or while driving.

Trunk lid emergency release light:

- emergency release button ① flashes for 30 minutes after the trunk lid is opened.
- emergency release button ① flashes for 60 minutes after the trunk lid is closed.

The trunk lid emergency release does not unlock the trunk lid if the battery is disconnected or discharged.

If the vehicle was locked centrally, opening the trunk lid with the trunk lid emergency release triggers the anti-theft alarm system.

Side windows

Important safety notes

WARNING

When opening and closing the side windows, make sure that nobody can be injured by the opening or closing procedure.

The side windows are equipped with automatic operation and anti-entrapment

features. If, in automatic operation mode, a side window encounters an obstruction that blocks its path, the anti-entrapment feature will stop the side window and open it slightly. The side windows operate differently when the switch is pulled and held. These details can be found in the "Closing a blocked side window" section in this chapter.

The closing of the side windows can be immediately halted by releasing the switch or, if the switch was pulled past the resistance point and released, by pressing or pulling the respective switch.

If a side window encounters an obstruction that blocks its path when you are closing the side windows by pressing and holding the  button on the SmartKey, the anti-entrapment feature will not operate.

WARNING

Do not keep any part of your body up against the window pane when opening a window. The downward motion of the pane may pull that part of your body down between the window pane and the door frame and trap it there. If there is a risk of entrapment, release the switch and pull it to close the window.

Observe the important safety notes in the "Children in the vehicle" section (▷ page 51).

Opening and closing the side windows



- ① Left side window
- ② Right side window

The switches for both side windows are located on the driver's door. There is also a switch for the front-passenger side window on the front-passenger door.

The switches on the driver's door take precedence.

▶ Select key position **2** with the Start/Stop button (▷ page 113).

▶ **To open:** press corresponding switch ① or ②.

▶ **To close:** pull corresponding switch ① or ②.

i If you press the switch beyond the point of resistance, an automatic opening/closing process is started in the corresponding direction. You can stop automatic operation by operating the switch again.

i You can continue to operate the side windows after you switch off the engine. This function is available for up to five minutes or until the driver's or front-passenger door is opened.



Opening and closing all side windows (Roadster)

Using the SmartKey





WARNING

Make sure that nobody can become trapped as you close the side windows.

Proceed as follows if there is a risk of entrapment:

- release the  button.
- press and hold the  button until the side windows open again.

If the soft top is closed, you can use the SmartKey to simultaneously open or close all of the side windows:



- ▶ Make sure that the soft top is closed (▷ page 77).
- ▶ Point the tip of the SmartKey at the driver's door handle.
- ▶ **To open all side windows:** press the  button on the SmartKey until the side windows are fully opened.
- ▶ **To interrupt the opening procedure:** release the  button.
- ▶ **To close all side windows:** press the  button on the SmartKey until the side windows are fully closed.
- ▶ **To interrupt the closing procedure:** release the  button.

Convenience opening (Coupe)

WARNING

When closing the side windows, make sure there is no danger of anyone being harmed by the closing procedure.



Proceed as follows in a potentially dangerous situation:

- Release the  button to interrupt the closing procedure.
- Press and hold the  button to open. To continue the closing procedure after

ensuring that nobody can be injured by the closing procedure, press and hold the



 button.

When you lock the vehicle, you can simultaneously close both side windows from outside.

- i** The SmartKey must be close to the driver's door handle.
 - ▶ Point the tip of the SmartKey at the driver's door handle.
 - ▶ Lock the vehicle with the  button.
 - ▶ Press and hold the  button until the side windows are fully closed.
 - ▶ Make sure that all the side windows are closed.

Convenience closing (Coupe)

You can ventilate the vehicle before you start driving. To do so, open the side windows using the SmartKey.

- i** The SmartKey must be close to the driver's door handle.
 - ▶ Point the tip of the SmartKey at the driver's door handle.
 - ▶ Unlock the vehicle by pressing the  button.
 - ▶ Press and hold the  button until the side windows are in the desired position.
 - ▶ **To interrupt convenience opening:** release the  button.

Problems with the side windows

Problem	Possible causes/consequences and ► Solutions
A side window will not close.	<p>Objects prevent it from closing.</p> <ul style="list-style-type: none"> ► Remove the objects. ► Close the side window.
A side window will not close.	<p>You cannot see the cause.</p> <p>If a side window is obstructed during closing and reopens again slightly:</p> <ul style="list-style-type: none"> ► Immediately after the window blocks, pull the corresponding switch again until the side window has closed. The side window is closed with increased force. <p>⚠ WARNING</p> <p>Pulling and holding the switch to close the door window immediately after it had been blocked two times will cause the door window to close without the anti-entrapment feature for as long as you hold the switch.</p> <p>If a side window is obstructed again during closing and reopens again slightly:</p> <ul style="list-style-type: none"> ► Immediately after the window blocks, pull the corresponding switch again until the side window has closed. The side window is closed without the anti-entrapment feature.

Soft top (Roadster)

Important safety notes

⚠ WARNING

Only drive with the soft top fully open or closed.

If the soft top does not open or close fully, the soft-top hydraulics are depressurized and the soft top is lowered:

- after about seven minutes if the ignition is switched on
- immediately if the ignition is switched off

A warning tone sounds shortly beforehand. The **Top lowering** message appears in the multifunction display..

Lock the soft top again before driving on. Otherwise the unlocked soft top could open

during the journey and cause you to lose control of your vehicle. You and/or other persons could be injured as a result.

You can open or close the soft top:

- if the vehicle is stationary or
- if the speed does not exceed 30 mph (50 km/h)

If there is a strong head wind, it may not be possible to close the soft top fully. In order to close the soft top fully, reduce speed or stop.

For safety reasons, Mercedes-Benz recommends that you only open or close the soft top when the vehicle is stationary.

! Never sit on the soft top when it is closed or store heavy objects on it. You will

otherwise damage the soft top of the vehicle.

- !** When opening and closing the soft top, make sure that:
- there is sufficient clearance above it, as the soft top swings upwards.
 - there are no objects on the soft top or the soft-top covers to the side.
 - the fabric is not dirty, wet or frozen
 - the outside temperature is above -10 °C.
- You could otherwise damage the soft top as well as other parts of the vehicle.

- i** Make sure that the soft top is dry and clean before closing it. Otherwise, water or dirt could enter the vehicle interior or trunk.

Opening and closing with the soft top switch

Important safety notes

! WARNING

Make sure nobody can be trapped or injured by moving parts, such as the soft-top linkage or soft-top compartment cover, when opening or closing the soft top.

Release the soft-top switch in the event of danger. The soft-top mechanism stops immediately.

! WARNING

The soft top stops moving during the opening or closing procedure if you drive faster than 30 mph (50 km/h). This could impair your rear view. At high speeds the soft top may be damaged.

Reduce your speed to below 30 mph (50 km/h) or stop in accordance with traffic conditions. Press the soft-top switch again in order to open or close the soft top fully.

Opening and closing

- ▶ When the vehicle is stationary, depress the brake pedal.
- ▶ Select key position **1** using the Start/Stop button (▶ page 113).

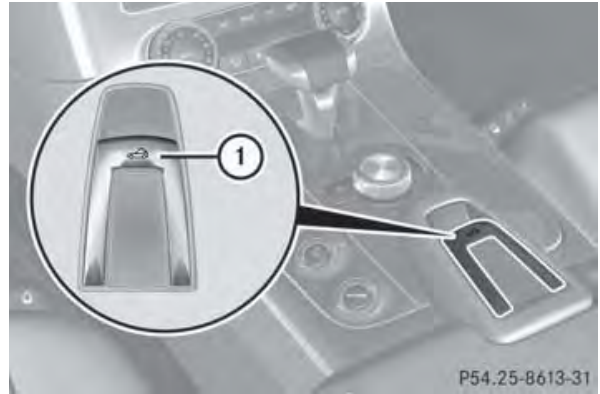

- ▶ **To open:** pull soft-top switch **1** until the soft top is fully opened. The **Convertible Top in Operation** message appears in the multifunction display.

If, when opening, you drive at speeds above 30 mph (50 km/h), the opening procedure is stopped and in the multifunction display you see the **Open/Close Convertible Top Completely** message. Reduce your speed again to below 30 mph (50 km/h) and pull the soft-top switch again to open the soft top fully.

- ▶ **To close:** press and hold soft-top switch **1** until the soft top is fully closed. The **Convertible Top in Operation** message appears in the multifunction display.



If, when closing, you drive at speeds above 30 mph (50 km/h), the closing procedure is stopped and in the multifunction display you see the **Open/Close Convertible Top Completely** message. Reduce speed back to under 30 mph (50 km/h) and push the soft top switch again to fully close the soft top.

Opening and closing using the SmartKey

Important safety notes

WARNING

Make sure nobody can be trapped or injured by moving parts, such as the soft-top linkage or soft-top compartment cover, when opening or closing the soft top.

If there is a risk of entrapment, immediately release the  or  button on the SmartKey. The soft-top mechanism stops immediately.

Opening and closing

 The SmartKey must be close to the driver's door handle.

► Point the tip of the SmartKey at the driver's door handle.

► **To open:** press and hold the  button on the SmartKey until the soft top is fully opened.

The **Convertible Top in Operation** message appears in the multifunction display.

► **To close:** press and hold the  button on the SmartKey until the soft top is fully closed.

The **Convertible Top in Operation** message appears in the multifunction display. The soft top and the side windows close.

Relocking the soft top

WARNING

Stop the vehicle at a suitable location as soon as it is possible to do so safely and lock the soft top before driving on. You could otherwise endanger yourself and others.

The soft top is not locked if:

- the **Convertible Top in Operation** message appears in the multifunction display.
- you hear a warning tone for up to ten seconds when pulling away or while driving.

You can lock the soft top again if it is not locked fully.

- Pull over and stop the vehicle safely as soon as possible, paying attention to road and traffic conditions.
- Select key position **2** with the Start/Stop button (▷ page 113).
- Press the soft-top switch.

Installing/removing the wind screen

WARNING

You could lose control of the vehicle and injure yourself or others if you operate the wind screen while driving.

Install or remove the wind screen only when the vehicle is stationary.

WARNING

If the wind screen is not properly engaged and the fastening levers are not folded outwards, it could become detached while driving. There is a risk of accident and injury.

Make sure that you push in the wind screen up to the locking point and then fold the fastening levers outwards.

 Install or remove the wind screen only when the soft top is open. You could otherwise damage the wind screen or the vehicle interior.

 Mercedes-Benz recommends that you only use wind screens which have been tested and approved for Mercedes-Benz vehicles. This helps to prevent damage to the vehicle.

The wind screen protects against wind when driving with the soft top open. It is secured between the roll bars.

The wind screen is in a bag on the tank partition wall in the trunk.

- ▶ Open the trunk.



- ▶ Detach wind screen bag ① from four press-studs ② on the tank partition wall.
- ▶ Remove the wind screen from wind screen bag ①.
- ▶ Attach wind screen bag ① to the tank partition wall again.

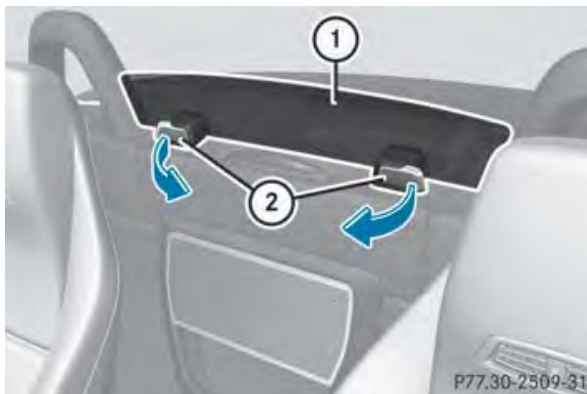

- ▶ **To install:** fold both fastening levers ② inwards in the direction of the arrow.
- ▶ Push wind screen ① into the recess between the roll bars up to the locking point.
- ▶ Fold both fastening levers ② outwards.
- ▶ **To remove:** fold both fastening levers ② inwards in the direction of the arrow.
- ▶ Pull wind screen ① upward.

- ▶ Detach the wind screen bag, remove it from the trunk and put the wind screen back into it.
- ▶ Attach the wind screen bag to the tank partition wall in the trunk again.

Problems with the soft top

Problem	Possible causes/consequences and ► Solutions
The soft top will not open or close.	Key position 1 is not selected. ► Select key position 1 using the Start/Stop button.
	The brake pedal has not been depressed with the vehicle stationary. ► Depress the brake pedal.
	The soft-top mechanism or control system is defective. ► Visit a qualified specialist workshop.
	The soft top has been opened and closed several times in a row. The soft-top drive has been deactivated automatically for safety reasons. You can open and close the soft top again after approximately ten minutes. ► Switch off the ignition and turn it back on. ► Repeat the opening or closing procedure.

Useful information	82
Correct driver's seat position	82
Seats	83
Steering wheel	86
Mirrors	87
Memory function	89

Useful information

i This Operator's Manual describes all models and all standard and optional equipment of your vehicle available at the time of publication of the Operator's Manual. Country-specific differences are possible. Please note that your vehicle may not be equipped with all features described. This also applies to safety-related systems and functions.

i Please read the information on qualified specialist workshops (▷ page 22).

Correct driver's seat position



Observe the safety guidelines on seat adjustment (▷ page 83).

► Make sure that seat ③ is adjusted properly.

Electrical seat adjustment (▷ page 84)

When adjusting the seat, make sure that:

- you are as far away from the driver's air bag as possible.
- you are sitting in a normal upright position.

- you can fasten the seat belt properly.
- you have moved the backrest to an almost vertical position.
- you have set the seat cushion angle so that your thighs are gently supported.
- you can depress the pedals properly.

Observe the safety guidelines on steering wheel adjustment (▷ page 86).

► Make sure that steering wheel ① is adjusted properly.

Adjusting the steering wheel electrically (▷ page 86)

When adjusting the steering wheel, make sure that:

- you can hold the steering wheel with your arms slightly bent.
- you can move your legs freely.
- you can see all the displays in the instrument cluster clearly.

Observe the safety guidelines for seat belts (▷ page 47).

► Check whether you have fastened seat belt ② properly (▷ page 49).

The seat belt should:

- fit snugly across your body
- be routed across the middle of your shoulder
- be routed in your pelvic area across the hip joints

► Before starting off, adjust the rear-view mirror and the exterior mirrors (▷ page 87) in such a way that you have a good view of road and traffic conditions.

► **Vehicles with a memory function:** save the seat, steering wheel and exterior mirror settings (▷ page 89).

Seats

Important safety notes

WARNING

In order to avoid possible loss of vehicle control, the following must be done before the vehicle is put into motion:

- seat adjustment
- steering wheel adjustment
- rear-view mirror adjustment
- fastening of seat belts

WARNING

In order to avoid possible loss of vehicle control, all seat, head restraint, steering wheel and rear view mirror adjustments, as well as fastening of seat belts, must be done before setting the vehicle in motion.

WARNING

Do not adjust the driver's seat while driving. Adjusting the seat while driving could cause the driver to lose control of the vehicle.

Never travel in a moving vehicle with the seat backrest in an excessively reclined position as this can be dangerous. You could slide under the seat belt in a collision. If you slide under it, the seat belt would apply force at the abdomen or neck. This could cause serious or fatal injuries. The seat backrest and seat belts provide the best restraint when the wearer is in a position that is as upright as possible and seat belts are properly positioned on the body.

WARNING

Your seat belt must be adjusted so that you can correctly fasten your seat belt.

Observe the following points:

- adjust the seat backrest until your arms are slightly angled when holding the steering wheel.
- adjust the seat to a comfortable seating position that still allows you to reach the

accelerator/brake pedal safely. The position should be as far back as possible with the driver still able to operate the controls properly.

- adjust the head restraint so that it is as close to the head as possible and the center of the head restraint supports the back of the head at eye level.
- never place hands under the seat or near any moving parts while a seat is being adjusted.

Failure to do so could result in an accident and/or serious personal injury.

WARNING

The electrically adjustable seats can be operated at any time. Therefore, do not leave children unattended in the vehicle, or with access to an unlocked vehicle. A child's unsupervised access to a vehicle could result in an accident and/or serious personal injury.

WARNING

Children 12 years old and under must be seated and properly secured in an appropriately sized infant restraint, toddler restraint or booster seat recommended for the size and weight of the child. For additional information, see section "Children in the vehicle".

A child's risk of serious or fatal injuries is significantly increased if the child restraints are not properly secured in the vehicle and/or the child is not properly secured in the child restraint.

! To avoid damage to the seats and the seat heating, observe the following information:

- do not spill any liquids on the seats. If liquid is spilled on the seats, dry them as soon as possible.
- if the seat covers are damp or wet, do not switch on the seat heating. The seat heating should also not be used to dry the seats.

- clean the seat covers as recommended; see the "Interior care" section.
- do not transport heavy loads on the seats. Do not place sharp objects on the seat cushions, e.g. knives, nails or tools. The seats should only be occupied by passengers, if possible.
- when the seat heating is in operation, do not cover the seats with insulating materials, e.g. blankets, coats, bags, seat covers, child seats or booster seats.

! When you move the seats, make sure that there are no objects in the footwell or behind the seats. Otherwise, you could damage the seats and the objects.

Seat adjustment

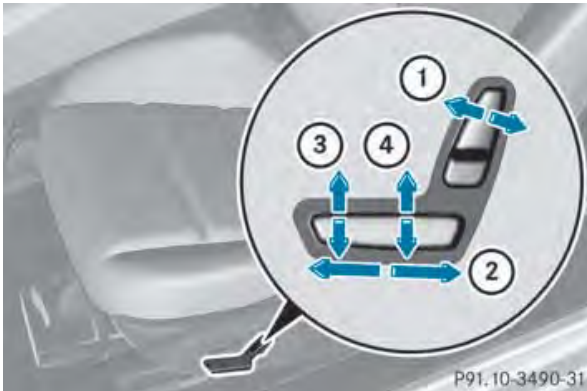

- ① Backrest angle
- ② Seat fore-and-aft adjustment
- ③ Seat cushion angle
- ④ Seat height

i You can store the seat settings using the memory function (▷ page 89).

Adjusting the lumbar support

You can adjust the contour of the seat so as to provide optimum support for your back.

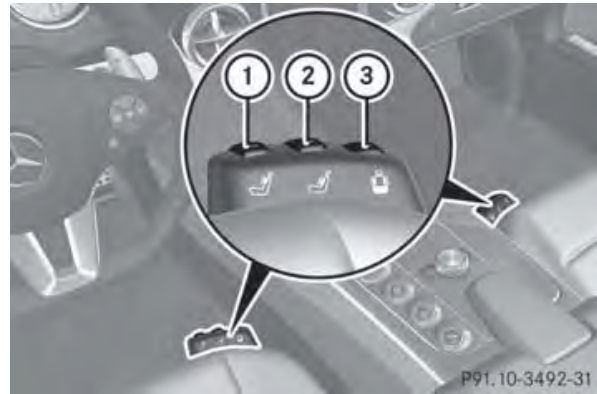

- ① To adjust the upper back support
- ② To adjust the contour of the backrest in the lumbar region
- ③ To adjust the lateral structure and support of the seat

▶ Select key position **2** with the Start/Stop button.

i If, after a certain amount of time, the seat no longer has the desired contour, repeat the adjustment.

Switching the seat heating on/off

Switching on/off

! WARNING

Repeatedly setting the seat heating to level **3** may result in excessive seat temperatures. The health of passengers that have limited temperature sensitivity or a limited ability to react to excessively high temperatures may be affected or they may even suffer burn-like injuries. Therefore, do not use seat heating level **3** repeatedly.

The three red indicator lamps in the button indicate the heating level you have selected.

i If the battery voltage is too low, the seat heating may switch off.



The system automatically switches down from level **3** to level **2** after approximately five minutes.

The system automatically switches down from level **2** to level **1** after approximately ten minutes.

The system automatically switches off approximately 20 minutes after it is set to level **1**.

- ▶ Select key position **2** with the Start/Stop button.
- ▶ **To switch on:** press button ① repeatedly until the desired heating level is set.
- ▶ **To switch off:** press button ① repeatedly until all the indicator lamps go out.

Problems with the seat heating

The seat heating has switched off prematurely or cannot be switched on. The vehicle's electrical system voltage is too low because too many electrical consumers are switched on.

- ▶ Switch off electrical consumers that you do not need, such as the rear window defroster or interior lighting. Once the battery is sufficiently charged, the seat heating will switch back on automatically.

AIRSCARF (Roadster)

WARNING

Very hot air can flow out of the AIRSCARF vents in the head restraints when AIRSCARF is in operation. This can cause burns on unprotected skin near the AIRSCARF vents. Make sure that you reduce the heater output in time.

The AIRSCARF function warms the head and neck area of vehicle occupants with warm air. The warm air flows out of the holes in the head restraints.

The three red indicator lamps in the button indicate the heating level you have selected.

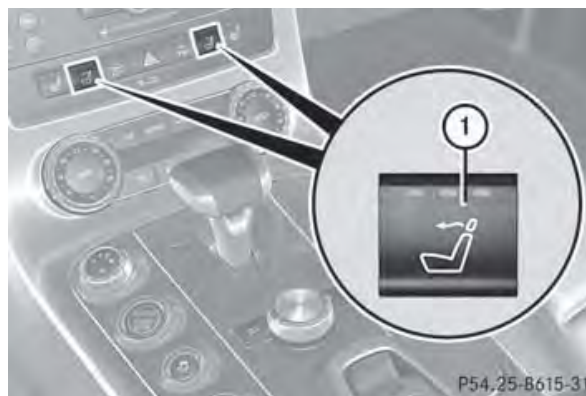

- ▶ Make sure that the SmartKey is in position **2** in the ignition lock.
- ▶ **To activate:** press button ①. Three red indicator lamps in the button light up. The blower starts up after a preheating phase of seven seconds.
- ▶ Press button ① repeatedly until the desired heating level is set.
- ▶ **To switch off:** press button ① repeatedly until all the indicator lamps go out.

You can use the adjustable fins on the head restraint to adjust the height of the current of air blown out according to your height.

Make sure that there are no objects covering the intake grille on the back of the driver's seat backrest.

- i** The blower continues running for seven seconds to cool down the heating elements.

- i** If the battery voltage is too low, AIRSCARF may switch off.

Steering wheel

Important safety notes

⚠ WARNING

Do not adjust the steering wheel while driving. Adjusting the steering wheel while driving could cause the driver to lose control of the vehicle.

The electrical steering wheel adjustment feature can be operated at any time. Therefore, do not leave children unattended in the vehicle, or with access to an unlocked vehicle. A child's unsupervised access to a vehicle could result in an accident and/or serious personal injury.

Adjusting the steering wheel

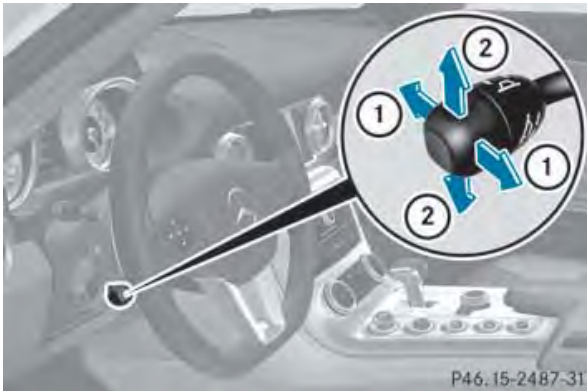

- ① To adjust the steering wheel position (fore-and-aft adjustment)
 - ② To adjust the steering wheel height
- i** Other topics:
- EASY-ENTRY/EXIT feature (▷ page 86)
 - Storing settings (▷ page 89)

EASY-ENTRY/EXIT feature

Important safety notes

The EASY-ENTRY/EXIT feature makes getting in and out of your vehicle easier.

You can activate and deactivate the EASY-ENTRY/EXIT feature in the on-board computer (▷ page 156).

⚠ WARNING

You must make sure no one can become trapped or injured by the moving steering wheel when the easy-entry/exit feature is activated.

To stop steering wheel movement, move steering wheel adjustment stalk or press the memory position switch.

Do not leave children unattended in the vehicle, or with access to an unlocked vehicle. Children could open the driver's door and unintentionally activate the easy-entry/exit feature, which could result in an accident and/or serious personal injury.

⚠ WARNING

Let the system complete the adjustment procedure before setting the vehicle in motion. All steering wheel adjustment must be completed before setting the vehicle in motion. Driving off with the steering wheel still adjusting could cause the driver to lose control of the vehicle.

Position of the steering wheel when the EASY-ENTRY/EXIT feature is active

The steering wheel swings upwards when you:

- remove the SmartKey from the ignition lock
 - open the driver's door with the KEYLESS-GO start function in position **1**
 - open the driver's door and the SmartKey is in position **0** or **1** in the ignition lock
- i** The steering wheel only moves upwards if it has not already reached the upper end stop.

Position of the steering wheel for driving

The steering wheel is moved to the last selected position when:

- the driver's door is closed.
- you press the Start/Stop button once.

When you close the driver's door with the ignition switched on, the steering wheel is also automatically moved to the previously set position.

The last position of the steering wheel is stored after each manual setting or when you store the setting with the memory function (▷ page 89).

Crash-responsive EASY-EXIT feature

If the crash-responsive EASY-EXIT feature is triggered in an accident, the steering column will move upwards when the driver's door is opened. This occurs irrespective of the position of the SmartKey in the ignition lock. This makes it easier to exit the vehicle and rescue the occupants.

The crash-responsive EASY-EXIT feature is only operational if the EASY-EXIT/ENTRY feature is activated in the on-board computer.

Mirrors

Rear-view mirror



- ▶ **Anti-glare mode:** flick anti-glare switch ① forwards or back.

Exterior mirrors

Adjusting the exterior mirrors

⚠ WARNING

Exercise care when using the passenger-side exterior rear view mirror. The mirror surface is convex (outwardly curved surface for a wider field of view). Objects in mirror are closer than they appear. Check your interior rear view mirror and glance over your shoulder before changing lanes.

The convex exterior mirrors provide a larger field of vision.

The exterior mirrors are heated automatically if the rear window defroster is switched on and the outside temperature is low. Mirror heating lasts up to 10 minutes.

- ⓘ You can also heat up the exterior mirrors manually by switching on the rear window defroster.



- ▶ Select SmartKey position 1 or 2 with the Start/Stop button.
- ▶ Press button ① for the left-hand exterior mirror or button ② for the right-hand exterior mirror. The indicator lamp in the corresponding button lights up in red. The indicator lamp goes out again after some time. You can adjust the selected mirror using adjustment button ③ as long as the indicator lamp is lit.
- ▶ Press adjustment button ③ up, down, or to the left or right until you have adjusted

the exterior mirror to the desired position. You should have a good overview of traffic conditions.

Folding the exterior mirrors in or out electrically

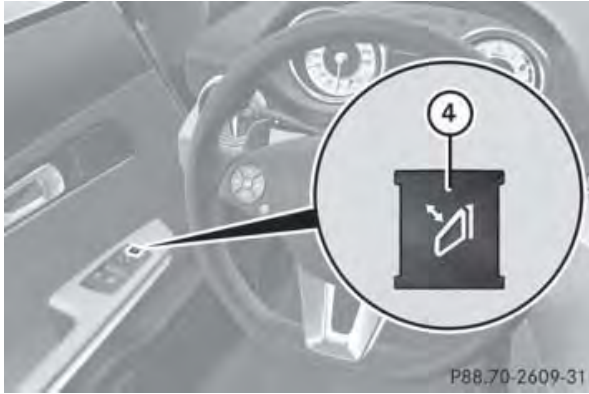

- ▶ Select SmartKey position **1** or **2** with the Start/Stop button.
- ▶ Briefly press button **(4)**.
Both exterior mirrors fold in or out.
- i** Make sure that the exterior mirrors are always folded out fully while the vehicle is in motion, as they may otherwise vibrate.
- i** If you are driving faster than 30 mph (47 km/h), you can no longer fold in the exterior mirrors.

Setting the exterior mirrors

If the battery has been disconnected or completely discharged, the exterior mirrors must be reset. The exterior mirrors will otherwise not fold in when you select the "Fold in mirrors when locking" function in the on-board computer (▷ page 156).

- ▶ Select SmartKey position **1** using the Start/Stop button.
- ▶ Briefly press button **(4)**.

Folding the exterior mirrors in or out automatically

If the "Fold in mirrors when locking" function is activated in the on-board computer (▷ page 156):

- the exterior mirrors fold in automatically as soon as you lock the vehicle from the outside.
- the exterior mirrors fold out again automatically as soon as you unlock the vehicle and then open the driver's or front-passenger door.

i The mirrors do not fold out if they have been folded in manually.

Exterior mirror pushed out of position

If an exterior mirror has been pushed out of position, proceed as follows:

- ▶ **Vehicles without electrically folding exterior mirrors:** move the exterior mirror into the correct position manually.
- ▶ **Vehicles with electrically folding exterior mirrors:** press and hold mirror-folding button until you hear a click and then the mirrors engage in position (▷ page 88).
The mirror housing is engaged again and you can adjust the exterior mirrors as usual (▷ page 87).

Automatic anti-glare mirrors

⚠ WARNING

If incident light from headlamps is prevented from striking the sensor in the rear-view mirror, for instance, by luggage piled too high in the vehicle, the mirror's automatic anti-glare function will not operate.

Incident light could then blind you. This may distract you from the traffic conditions and, as a result, you may cause an accident.

The rear-view mirror and the exterior mirror on the driver's side automatically go into anti-glare mode if the following conditions are met simultaneously:

- the ignition is switched on and
- incident light from headlamps strikes the sensor in the rear-view mirror.

The mirrors do not go into anti-glare mode if reverse gear is engaged.

Parking position for the exterior mirror on the front-passenger side

Setting and storing the parking position

You can position the front-passenger side exterior mirror in such a way that you can see the rear wheel on that side as soon as you engage reverse gear. You can store this position.



- ▶ Select SmartKey position **2** with the Start/Stop button.
 - ▶ Press button **②** for the exterior mirror on the front-passenger side.
 - ▶ Engage reverse gear.
The exterior mirror on the front-passenger side moves to the preset parking position.
 - ▶ Use adjustment button **③** to adjust the exterior mirror to a position that allows you to see the rear wheel and the curb.
The parking position is stored.
- i** If you shift the transmission to another position, the exterior mirror on the front-passenger side returns to the driving position.

Calling up a stored parking position setting

- ▶ Select SmartKey position **2** with the Start/Stop button.
- ▶ Adjust the exterior mirror on the front-passenger side with the corresponding button (▷ page 87).
- ▶ Engage reverse gear.
The exterior mirror on the front-passenger side moves to the stored parking position.

The exterior mirror on the front-passenger side moves back to its original position:

- as soon as you exceed a speed of 6 mph (10 km/h)
- about ten seconds after you have disengaged reverse gear
- if you press button **①** for the exterior mirror on the driver's side

Memory function

Storing settings

WARNING

Do not activate the memory function while driving. Activating the memory function while driving could cause the driver to lose control of the vehicle.

With the memory function, you can store up to three different settings, e.g. for three different people.

The following settings are stored as a single memory preset:

- seat and backrest position
- driver's side: steering wheel position
- driver's side: position of the exterior mirrors on the driver's and front-passenger sides

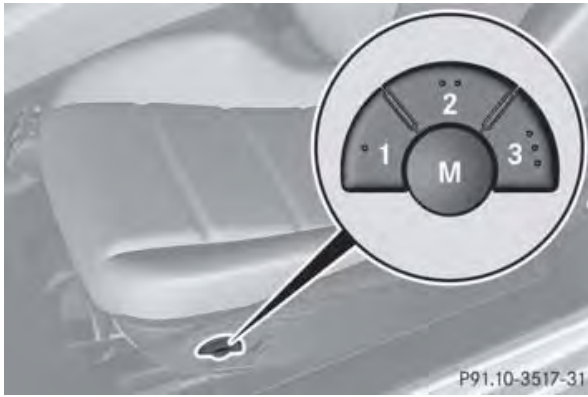

- ▶ Select SmartKey position **2** with the Start/Stop button.
- ▶ Adjust the seat (▷ page 84).
- ▶ On the driver's side, adjust the steering wheel (▷ page 86) and the exterior mirrors (▷ page 87).
- ▶ Press memory button **M** and one of the storage position buttons **1**, **2** or **3** within three seconds.
The settings are stored in the selected preset position. A tone sounds when the settings have been completed.

Calling up a stored setting

- ▶ Press and hold the relevant storage position button **1**, **2** or **3** until the seat, steering wheel and exterior mirrors are in the stored position.
- i** The setting procedure is interrupted as soon as you release the storage position button.

Useful information	92
Exterior lighting	92
Interior lighting	95
Replacing bulbs	96
Windshield wipers	97

Useful information

i This Operator's Manual describes all models and all standard and optional equipment of your vehicle available at the time of publication of the Operator's Manual. Country-specific differences are possible. Please note that your vehicle may not be equipped with all features described. This also applies to safety-related systems and functions.

i Please read the information on qualified specialist workshops (▷ page 22).

Exterior lighting

Important safety notes

For reasons of safety, Mercedes-Benz recommends that you drive with the lights switched on even during the daytime. In some countries, operation of the headlamps varies due to legal requirements and self-imposed obligations.

Notes on driving abroad

Converting to symmetrical low beam when driving abroad: switch the headlamps to symmetrical low beam in countries in which traffic drives on the opposite side of the road to the country where the vehicle is registered. This prevents glare to oncoming traffic. Symmetrical lights do not illuminate as large an area of the edge of the road. Have the headlamps converted at a qualified specialist workshop, e.g. an authorized Mercedes-Benz Center, as close to the border as possible before driving in these countries.

Converting to asymmetrical low beam after returning: have the headlamps converted back to asymmetrical low beam at a qualified specialist workshop, e.g. an authorized Mercedes-Benz Center, as soon as possible after crossing the border again.

Setting the exterior lighting

Setting options

Exterior lighting can be set using:

- the light switch
- the combination switch (▷ page 94)
- the on-board computer (▷ page 154)

Light switch

Operation



- 1** Left-hand standing lamps
- 2** Right-hand standing lamps
- 3** Parking lamps, license plate and instrument cluster lighting
- 4** **AUTO** Automatic headlamp mode, controlled by the light sensor
- 5** Low-beam/high-beam headlamps

If you hear a warning tone when you leave the vehicle, the lights may still be switched on.

► Turn the light switch to **AUTO**.

The exterior lighting (except the parking/standing lamps) switches off automatically if you:

- remove the SmartKey from the ignition lock
- open the driver's door with the SmartKey in position **0**.

Automatic headlamp mode

WARNING

When the light switch is set to **AUTO**, the low-beam headlamps may not be switched on automatically if there is fog, snow or other

causes of poor visibility due to the weather conditions such as spray. There is a risk of an accident.

In such situations, turn the light switch to



The automatic headlamp feature is only an aid. The driver is responsible for the vehicle's lighting at all times.

AUTO is the favored light switch setting. The light setting is automatically selected according to the brightness of the ambient light (exception: poor visibility due to weather conditions such as fog, snow or spray):

- SmartKey in position **1** in the ignition lock: the parking lamps are switched on or off automatically depending on the brightness of the ambient light.
- With the engine running: if you have activated the daytime running lamps function via the on-board computer, the daytime running lamps or the low-beam headlamps and parking lamps are switched on or off automatically depending on the brightness of the ambient light.

Only for Canada:

The daytime running lamps improve the visibility of your vehicle during the day. The daytime running lamps function is required by law in Canada. It cannot therefore be deactivated.



When the engine is running and the vehicle is stationary: if you move the selector lever from a drive position to **P**, the daytime running lamps/low-beam headlamps go out after three minutes.

When the engine is running, the vehicle is stationary and in high ambient light: if you turn the light switch to , you turn on the daytime running lamps and parking lamps.

If the engine is running and you turn the light switch to , the manual settings take precedence over the daytime running lamps.

USA only:

The daytime running lamps improve the visibility of your vehicle during the day. To do this, the daytime running lamps function must be switched on using the on-board computer (▷ page 154).

If the engine is running and you turn the light switch to  or , the manual settings take precedence over the daytime running lamps.

i In the USA, the daytime running lamps are deactivated upon delivery from the factory.

► **To switch on automatic headlamp mode:** turn the light switch to **AUTO**.

Low-beam headlamps

WARNING

When the light switch is set to **AUTO**, the low-beam headlamps may not be switched on automatically if there is fog, snow or other causes of poor visibility due to the weather conditions such as spray. There is a risk of an accident.

In such situations, turn the light switch to



Even if the light sensor does not detect that it is dark, the parking lamps and low-beam headlamps switch on when the ignition is switched on and the light switch is set to the  position. This is a particularly useful function in the event of rain and fog.



► **To switch on the low-beam headlamps:** turn the SmartKey in the ignition lock to position **2** or start the engine.

► Turn the light switch to .

The green  indicator lamp in the instrument cluster lights up.

Parking lamps



! If the battery has been excessively discharged, the parking lamps or standing lamps are automatically switched off to enable the next engine start. Always park your vehicle safely and sufficiently lit according to legal standards. Avoid the

continuous use of the  parking lamps for several hours. If possible, switch on the  right or the  left standing lamp.

- ▶ **To switch on:** turn light switch to .

Standing lamps

Switching on the standing lamps ensures the corresponding side of the vehicle is illuminated.

- ▶ **To switch on the standing lamps:** the SmartKey is not in the ignition lock or it is in position **0**.
- ▶ Turn the light switch to  (left-hand side of the vehicle) or  (right-hand side of the vehicle).

Combination switch

Turn signal



- ① High-beam headlamps
- ② Right turn signal
- ③ High-beam flasher
- ④ Left turn signal

- ▶ **To indicate briefly:** press the combination switch briefly to the pressure point in the direction of arrow ② or ④.

The corresponding turn signal flashes three times.

- ▶ **To indicate:** press the combination switch beyond the pressure point in the direction of arrow ② or ④.

High-beam headlamps

- ▶ **To switch on the high-beam headlamps:** turn the SmartKey in the ignition lock to position **2** or start the engine.

- ▶ Turn the light switch to  or **AUTO**.

- ▶ Press the combination switch beyond the pressure point in the direction of arrow ①.

In the **AUTO** position, the high-beam headlamps are only switched on when it is dark and the engine is running.

The  indicator lamp in the instrument cluster lights up when the high-beam headlamps are switched on.

- ▶ **To switch off the high-beam headlamps:** move the combination switch back to its normal position.

The  indicator lamp in the instrument cluster goes out.

High-beam flasher

- ▶ **To switch on:** turn the SmartKey in the ignition lock to position **1** or **2** or start the engine.

- ▶ Pull the combination switch briefly in the direction of arrow ③.

Hazard warning lamps

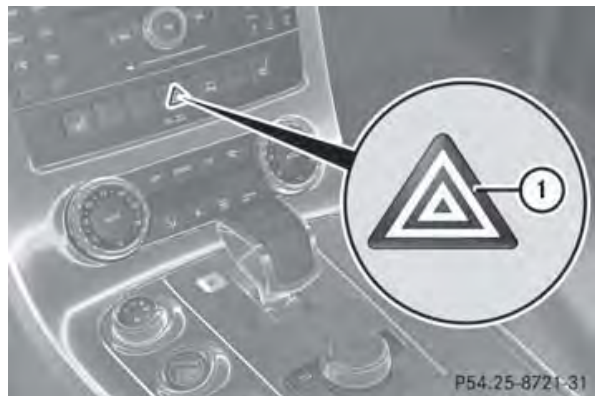

The hazard warning lamps automatically switch on if:

- an air bag is deployed
- the vehicle decelerates rapidly from a speed of more than 45 mph (70 km/h) and comes to a standstill.

► **To switch on the hazard warning lamps:** press button ①.

All turn signals flash. If you now switch on a turn signal using the combination switch, only the turn signal lamp on the corresponding side of the vehicle will flash.

► **To switch off the hazard warning lamps:** press button ①.

The hazard warning lamps switch off automatically if the vehicle exceeds a speed of 6 mph (10 km/h) again after a full brake application.

- ❗ The hazard warning lamps still operate if the ignition is switched off.

Headlamp cleaning system

The headlamps are cleaned automatically if the "Wipe with washer fluid" function is operated five times (▷ page 97) while the lights are on and the engine is running. When you switch off the ignition, the automatic headlamp cleaning system is reset and counting is resumed from 0.

Headlamps fogged up on the inside

The headlamps may fog up on the inside if there is high atmospheric humidity.

- Drive with the headlamps switched on. The level of moisture diminishes, depending on the length of the journey and the weather conditions (humidity and temperature).

If the level of moisture does not diminish:



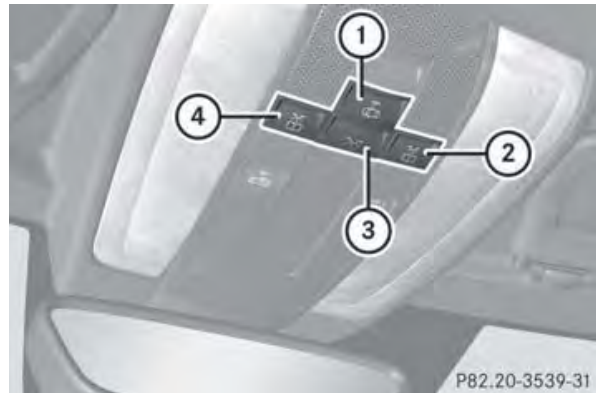

- Have the headlamps checked at a qualified specialist workshop.

Interior lighting

Overview of interior lighting



Overhead control panel

- ①  Switches the automatic interior lighting control on/off
- ②  Switches the right-hand reading lamp on/off
- ③  Switches the interior lighting on/off
- ④  Switches the left-hand reading lamp on/off

Interior lighting control

General notes

In order to prevent the vehicle's battery from discharging, the interior lighting functions are automatically deactivated after some time unless the SmartKey is in position **2** in the ignition lock.

Automatic interior lighting control

- **To activate/deactivate:** press the  button.



When the automatic interior lighting control is activated, the button is flush with the overhead control panel.

The interior lighting automatically switches on if you:

- unlock the vehicle
- open a door
- remove the SmartKey from the ignition lock

The interior light is activated for a short while when the SmartKey is removed from the ignition lock. You can activate this delayed switch-off using the on-board computer (▷ page 155).

Manual interior lighting control

- ▶ **To switch the interior lighting on/off:** press the  button.
- ▶ **To switch the reading lamps on/off:** press the  button.

Crash-responsive emergency lighting

The interior lighting is activated automatically if the vehicle is involved in an accident.

- ▶ **To switch off the crash-responsive emergency lighting:** press the hazard warning lamp button.
- or
- ▶ Lock and then unlock the vehicle using the key.

Replacing bulbs

Important safety notes

Xenon bulbs

DANGER

Xenon bulbs carry a high voltage. You can get an electric shock if you remove the cover of the Xenon bulb and touch the electrical contacts. There is a risk of fatal injury.

Never touch the parts or the electrical contacts of the Xenon bulb. Always have work on the Xenon bulbs carried out at a qualified specialist workshop.

If your vehicle is equipped with Xenon bulbs, you can recognize this by the following: the cone of light from the Xenon bulbs moves from the top to the bottom and back again when you start the engine. For this to be

observed, the lights must be switched on before starting the engine.

Bulbs and lamps are an important aspect of vehicle safety. You must therefore make sure that these function correctly at all times. Have the headlamp setting checked regularly.

Other bulbs

WARNING

Bulbs, lamps and connectors can get very hot when operating. If you change a bulb, you could burn yourself on these components. There is a risk of injury.

Allow these components to cool down before changing a bulb.

There are bulbs other than the Xenon bulbs that you cannot replace. Replace only the bulbs listed (▷ page 97). Have the bulbs that you cannot replace yourself changed at a qualified specialist workshop.

If you require assistance changing bulbs, consult a qualified specialist workshop.

Do not touch the glass tube of new bulbs with your bare hands. Even minor contamination can burn into the glass surface and reduce the service life of the bulbs. Always use a lint-free cloth or only touch the base of the bulb when installing.

Only use bulbs of the correct type.

If the new bulb still does not light up, consult a qualified specialist workshop.

Bulbs and lamps are an important aspect of vehicle safety. You must therefore make sure that these function correctly at all times. Have the headlamp setting checked regularly.

Changing the front bulbs

You cannot replace the bulbs at the front yourself. Contact a qualified specialist workshop which has the necessary specialist knowledge and tools to carry out the work required. Mercedes-Benz recommends that

you use an authorized Mercedes-Benz Center for this purpose.

Changing the rear bulbs

License plate lamp

The only rear bulbs you can change are the W 5 W license plate lamp bulbs.



P82.10-6004-31

- ▶ Switch off the lights.
- ▶ Lever lamp housing ① out of the frame using a screwdriver.
- ▶ Unscrew the bulb holder from the lamp housing and pull out the bulb.
- ▶ Insert a new bulb into the bulb holder and screw the bulb holder into the lamp housing.
- ▶ Press the lamp housing back into the frame until it engages.

Windshield wipers

Switching the windshield wipers on/off

WARNING

The windshield will not longer be wiped properly if the wiper blades are worn. This could prevent you from observing the traffic conditions, thereby causing an accident. Replace the wiper blades twice a year, ideally in spring and fall.

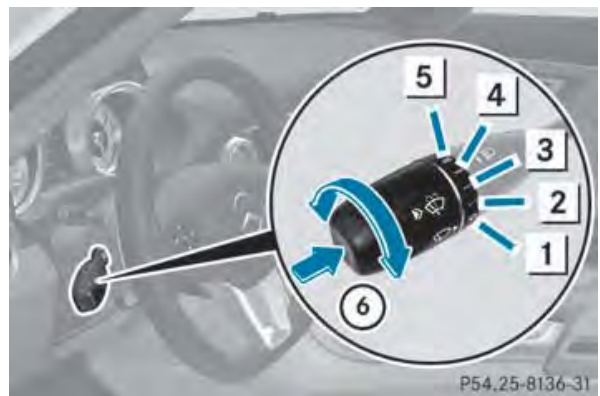

! Do not operate the windshield wipers when the windshield is dry, as this could damage the wiper blades. Moreover, dust that has collected on the windshield can scratch the glass if wiping takes place when the windshield is dry.

! If the windshield wipers leave smears on the windshield after the vehicle has been washed in an automatic car wash, wax or other residues may be the reason for this. Clean the windshield using washer fluid after washing the vehicle in an automatic car wash.



P54.25-8136-31

Combination switch

- ① 0 Windshield wiper off
- ② ... Intermittent wipe, low³
- ③ Intermittent wipe, high⁴
- ④ — Continuous wipe, slow
- ⑤ = Continuous wipe, fast
- ⑥  Single wipe/  To wipe the windshield using washer fluid





- ▶ Switch on the ignition.
- ▶ Turn the combination switch to the corresponding position.

! Intermittent wiping with rain sensor: due to optical influences and the windshield becoming dirty in dry weather conditions, the windshield wipers may be activated inadvertently. This could then damage the windshield wiper blades or scratch the windshield.

³ Rain sensor set to low sensitivity.

⁴ Rain sensor set to high sensitivity.

For this reason, you should always switch off the windshield wipers in dry weather.

In the  or  position, the appropriate wiping frequency is set automatically according to the intensity of the rain. In the  position, the rain sensor is more sensitive than in the  position, causing the windshield wipers to wipe more frequently.



Replacing the wiper blades

Important safety notes

WARNING

The wiper arms could start moving and cause an injury if you leave the windshield wipers switched on.

Remove the key from the ignition lock before replacing the wiper blades.

-  To avoid damaging the wiper blades, make sure that you touch only the wiper arm of the wiper.
-  Never open the hood if a windshield wiper arm has been folded away from the windshield.

Never fold a windshield wiper arm without a wiper blade back onto the windshield.

Hold the windshield wiper arm firmly when you change the wiper blade. If you release the windshield wiper arm without a wiper blade and it falls onto the windshield, the windshield may be damaged by the force of the impact.

Mercedes-Benz recommends that you have the wiper blades replaced by a qualified specialist workshop, e.g. at an authorized Mercedes-Benz Center.

Replacing the wiper blades

Removing the wiper blades

Moving the wiper arm to a vertical position

- ▶ Switch off the engine.
- ▶ Remove your foot from the brake pedal.
- ▶ Set the windshield wiper to the  position.
- ▶ Press the Start/Stop button repeatedly until the windshield wipers start.
- ▶ When the wiper arms have reached a vertical position, press the Start/Stop button.
- ▶ Fold the wiper arm away from the windshield until it engages.
- ▶ Set the wiper blade at right angles to the wiper arm.

Removing the wiper blades

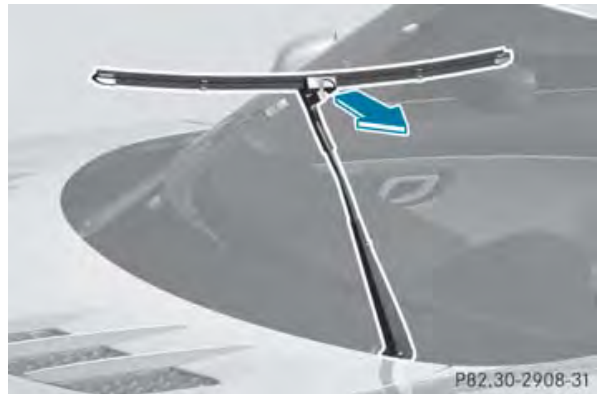

- ▶ Remove the wiper blade from the retainer on the wiper arm in the direction of the arrow.

Installing the wiper blades

- ▶ Slide the new wiper blade into the retainer on the wiper arm in the opposite direction to the arrow.
- ▶ Turn the wiper blade parallel to the wiper arm.
- ▶ Fold the wiper arm back onto the windshield.

Problems with the windshield wipers

The windshield wipers are obstructed

Leaves or snow, for example, may be obstructing the windshield wiper movement. The wiper motor has been deactivated.

- ▶ Switch off the engine using the Start/Stop button and open the driver's door.
- ▶ Remove the cause of the obstruction.
- ▶ Switch the windshield wipers back on.

The windshield wipers are inoperative

The windshield wiper drive is malfunctioning.

- ▶ Select another wiper speed on the combination switch.
- ▶ Have the windshield wipers checked at a qualified specialist workshop.

The spray nozzles are misaligned

The windshield washer fluid from the spray nozzles no longer hits the center of the windshield. The spray nozzles are misaligned.

- ▶ Have the spray nozzles adjusted at a qualified specialist workshop.

The wiper arms are on the windshield

The wiper arms have been moved by an external force.

- ▶ Select key position **2** (ignition) with the Start/Stop button.
The wiper arms move back down automatically.

Useful information	102
Overview of climate control systems	102
Operating the climate control systems	104
Setting the air vents	108

Useful information

- i** This Operator's Manual describes all models and all standard and optional equipment of your vehicle available at the time of publication of the Operator's Manual. Country-specific differences are possible. Please note that your vehicle may not be equipped with all features described. This also applies to safety-related systems and functions.
- i** Please read the information on qualified specialist workshops (▷ page 22).

Overview of climate control systems

Important safety notes

WARNING

Severe conditions (e.g. strong air pollution) may require replacement of the filter before its scheduled replacement interval. A clogged filter will reduce the air volume to the interior and the windows could fog up, impairing visibility and endangering you and others. Have a blocked filter replaced at a Mercedes-Benz Center as soon as possible.

WARNING

Follow the recommended settings for heating and cooling given on the following pages. Otherwise, the windows could fog up, impairing visibility and endangering you and others.

The automatic climate control regulates the temperature and the humidity in the vehicle interior and filters undesirable substances out of the air.

Coupe: the automatic climate control is only operational if the engine is running. Optimum operation is achieved only when you drive with the side windows closed.

Roadster: the automatic climate control is only operational if the engine is running. The

system only works optimally when the side windows and the roof are closed.

- i** **Coupe:** ventilate the vehicle for a brief period during warm weather. This will speed up the cooling process and the desired vehicle interior temperature will be reached more quickly.
Roadster: ventilate the vehicle for a brief period during warm weather. This will speed up the cooling process and the desired vehicle interior temperature will be reached more quickly.
- i** The integrated filter can filter out most particles of dust, and completely filters out pollen. A clogged filter reduces the amount of air supplied to the vehicle interior. For this reason, you should always observe the interval for replacing the filter, which is specified in the Maintenance Booklet. As it depends on environmental conditions, e.g. heavy air pollution, the interval may be shorter than stated in the Maintenance Booklet.

Control panel for dual zone automatic climate control



Canada only

- ① To set the temperature, left (▷ page 105)
- ② To set climate control to automatic (▷ page 105)
- ③ To switch climate control on/off (▷ page 104)
- ④ To switch the MONO function on/off
- ⑤ To switch cooling with air dehumidification on/off (▷ page 104)
- ⑥ To defrost the windshield (▷ page 106)
- ⑦ To activate/deactivate air-recirculation mode (▷ page 107)
- ⑧ To set the temperature, right (▷ page 105)
- ⑨ To switch the rear window defroster on/off (▷ page 107)
- ⑩ To increase the airflow (▷ page 106)
- ⑪ To reduce the airflow (▷ page 106)
- ⑫ Display
- ⑬ To set the air distribution (▷ page 105)



USA only

- ① To set the temperature, left
- ② To set climate control to automatic (▷ page 105)
- ③ To switch climate control on/off (▷ page 104)
- ④ To switch maximum cooling on/off (▷ page 106)
- ⑤ To switch cooling with air dehumidification on/off (▷ page 104)

- ⑥ To defrost the windshield (▷ page 106)
- ⑦ To activate/deactivate air-recirculation mode (▷ page 107)
- ⑧ To set the temperature, right (▷ page 105)
- ⑨ To switch the rear window defroster on/off (▷ page 107)
- ⑩ To increase the airflow (▷ page 106)
- ⑪ To reduce the airflow (▷ page 106)
- ⑫ Display
- ⑬ To set the air distribution (▷ page 105)

Notes on using automatic climate control

The following contains instructions and recommendations to enable you to get the most out of your automatic climate control.

- Activate climate control using the **AUTO** and **A/C** buttons. The indicator lamps in the **AUTO** and **A/C** buttons light up.
- Set the temperature to 72 °F (22 °C).
- Only use the defrosting function briefly until the windshield is clear again.
- Only use air-recirculation mode briefly, e.g. if there are unpleasant outside odors or when in a tunnel. The windows could otherwise fog up, since no fresh air is drawn into the vehicle in air-recirculation mode.
- Use the MONO function if you want to adopt the temperature and air distribution settings from the driver's side for all climate control zones. The indicator lamp in the **MONO** button lights up.

Operating the climate control systems

Switching climate control on/off

WARNING

When the climate control system is deactivated, the outside air supply and circulation are also deactivated. Only choose this setting for a short time. Otherwise the windows could fog up, impairing visibility and endangering you and others.

i Switch on climate control primarily using the **AUTO** button (▷ page 105).

▶ Select key position **2** with the Start/Stop button.

▶ **To activate:** press the **AUTO** button.

The indicator lamp in the **AUTO** button lights up. Airflow and air distribution are set to automatic mode.

or

▶ Press the **OFF** button.

The indicator lamp in the **OFF** button goes out. The previously selected settings are restored.

▶ **To deactivate:** press the **OFF** button.

The indicator lamp in the **OFF** button lights up.

Activating/deactivating cooling with air dehumidification

Points to observe before use





The cooling with air dehumidification function is only available when the engine is running. The air inside the vehicle is cooled and dehumidified according to the temperature selected.

WARNING

If you switch off the cooling function, the vehicle will not be cooled when weather conditions are warm. The windows can fog up more quickly. Window fogging may impair visibility and endanger you and others.

Condensation may drip from the underside of the vehicle when it is in cooling mode.

Activating/deactivating

- ▶ **To activate:** press the  button. The indicator lamp in the  button lights up.
- ▶ **To deactivate:** press the  button. The indicator lamp in the  button goes out. The cooling with air dehumidification function has a delayed switch-off feature.

Problems with the "cooling with air dehumidification" function

When you press the  button, the indicator lamp in the button flashes three times or remains off. You can no longer switch on the cooling with air dehumidification function.

- ▶ Visit a qualified specialist workshop.





Setting climate control to automatic

WARNING

If you switch off the cooling function, the vehicle will not be cooled when weather conditions are warm. The windows can fog up more quickly. Window fogging may impair visibility and endanger you and others.



In automatic mode, the set temperature is controlled automatically. The system automatically regulates the temperature of the dispensed air, the airflow and the air distribution.

Automatic mode will achieve optimal operation if cooling with air dehumidification is also activated. If necessary, cooling with air dehumidification can be deactivated.

- ▶ Select key position **2** with the Start/Stop button.
- ▶ Set the desired temperature.
- ▶ **To activate:** press the  button. The indicator lamp in the  button lights up. Automatic air distribution and airflow are activated.
- ▶ **To select manually:** press the  button. The indicator lamp in the  button goes out. Automatic air distribution and airflow are deactivated.







Setting the temperature

Different temperatures can be set for the driver's and front-passenger sides.

- ▶ Select key position **2** with the Start/Stop button.
- ▶ **To increase/reduce:** turn control  and  clockwise or counter-clockwise (▷ page 103).



Only change the temperature setting in small increments. Start at 72 °F (22 °C).

Setting the air distribution

-  Directs the airflow through the defroster vents
-  Directs the airflow through the center and side air vents
-  Directs the airflow through the footwell air vents
-  Directs the airflow through the center and side air vents as well as the footwell air vents
-  Directs the airflow to the entire vehicle interior
-  Directs the airflow through the center and side air vents, as well as the defroster vents
-  Directs the airflow through the footwell and defroster vents

- ▶ Select key position **2** with the Start/Stop button.
- ▶ Press the  button repeatedly until the desired symbol appears in the display. The indicator lamp in the **AUTO** button goes out. Automatic control is deactivated and the air distribution is controlled according to the selected setting.

Setting the airflow

- ▶ Select key position **2** with the Start/Stop button.
- ▶ **To increase/reduce:** press the  or  button.



Switching the mono function on/off



The MONO function is only available in vehicles for Canada.

You can use the MONO function to adopt the temperature and air distribution settings on the driver's side for the front-passenger side.

- ▶ Press the **MONO** button.
The indicator lamp in the **MONO** button lights up or goes out.

Defrosting the windshield

- i** You should only select the defrosting function until the windshield is clear again.
- ▶ Select SmartKey position **2** with the Start/Stop button.
- ▶ **To activate:** press the  button. The indicator lamp in the  button lights up. The system automatically switches to the following functions:
 - high airflow
 - high temperature
 - air distribution to the windshield and front side windows
 - air-recirculation mode off

- ▶ **To deactivate:** press the  button. The indicator lamp in the  button goes out. The previously selected settings are restored. Air-recirculation mode remains deactivated.

or

- ▶ Press the **AUTO** button. The indicator lamp in the  button goes out. Airflow and air distribution are set to automatic mode.

or

- ▶ Turn controls **①** or **⑧** clockwise or counter-clockwise (▷ page 103).

or



- ▶ Press the  or  button.

Switching maximum cooling on/off

The MAX COOL function is only available in vehicles for the USA.

MAX COOL is only operational when the engine is running.

When you activate MAX COOL, climate control switches to the following functions:



- maximum cooling
- maximum airflow
- air-recirculation mode on
- ▶ **To activate:** press the  button. The indicator lamp in the button lights up.
- ▶ **To deactivate:** press the  button again. The indicator lamp in the button goes out. The previously selected settings come into effect again.
- i** To deactivate MAX COOL press the **OFF**, **AUTO**, or  button.

Defrosting the windows

Windows fogged up on the inside

- ▶ Activate the cooling with air dehumidification function.
- ▶ Activate automatic mode.
- ▶ If the windows continue to fog up, activate the defrosting function.

Windows fogged up on the outside

- ▶ Activate the windshield wipers.
- ▶ Press the  button repeatedly until the  or  symbol appears in the display.
- i** You should only select this setting until the windshield is clear again.

Rear window defroster



Activating/deactivating

WARNING

Any accumulation of snow and ice should be removed from the rear window before driving. Visibility could otherwise be impaired, endangering you and others.

The rear window defroster has a high current draw. You should therefore switch it off as soon as the rear window is clear. Otherwise, the rear window defroster switches off automatically after several minutes.

If the battery voltage is too low, the rear window defroster may switch off.

- ▶ Select SmartKey position **2** with the Start/Stop button.
- ▶ Press the  button. The indicator lamp in the  button lights up or goes out.

Problems with the rear window defroster

The rear window defroster has deactivated prematurely or cannot be activated. The on-board voltage is too low because too many electrical consumers are switched on.

- ▶ Switch off any consumers that are not required, e.g. seat heating or interior lighting.



When the battery is sufficiently charged, the rear window defroster is activated again automatically.

Activating/deactivating air-recirculation mode



You can deactivate the flow of fresh air if unpleasant odors are entering the vehicle from outside. The air already inside the vehicle will then be recirculated.

WARNING

Fogged windows impair visibility, endangering you and others. If the windows begin to fog on the inside, switching off the air recirculation mode immediately should clear interior window fogging. If interior window fogging persists, make sure the air conditioning is activated, or press the  button.

- ▶ Select key position **2** with the Start/Stop button.
- ▶ **To activate:** press the  button. The indicator lamp in the  button lights up.

- i** Air-recirculation mode is activated automatically at high outside temperatures. When air-recirculation mode is activated automatically, the indicator lamp in the  button is not lit. Outside air is added after about 30 minutes.

- **To deactivate:** press the  button. The indicator lamp in the  button goes out.

- i** Air-recirculation mode deactivates automatically:
- after approximately five minutes at outside temperatures below approximately 41 °F (5 °C)
 - after approximately five minutes if cooling with air dehumidification is deactivated
 - after approximately 30 minutes at outside temperatures above approximately 41 °F (5 °C) if the "Cooling with air dehumidification" function is activated

Setting the air vents

Important safety notes

WARNING

When operating the climate control, the air that enters the passenger compartment through the air vents can be very hot or very cold (depending on the set temperature). This could cause burns or frostbite to unprotected skin in the immediate area of the air vents.

Always keep sufficient distance between unprotected parts of the body and the air vents. If necessary, use the air distribution adjustment to direct the air to air vents in the vehicle interior that are not in the immediate area of unprotected skin.

In order to ensure the direct flow of fresh air through the air vents into the vehicle interior, please observe the following notes:

- keep the air inlet on the right-hand side of the hood free of blockages, such as ice, snow or leaves.
- never cover the air vents or air intake grilles in the vehicle interior.

- i** For virtually draft-free ventilation, adjust the sliders of the air vents to the center position.

Setting the center air vents



- 1** To open the center air vent
2 To close the center air vent
3 Center air vent, right
4 Center air vent, left

- **To open the center air vent:** turn the adjuster in center air vent **3** or **4** in the direction of the arrow to position **1**.
- **To close the center air vent:** turn the adjuster in center air vent **3** or **4** in the direction of the arrow to position **2**.

Setting the side air vents

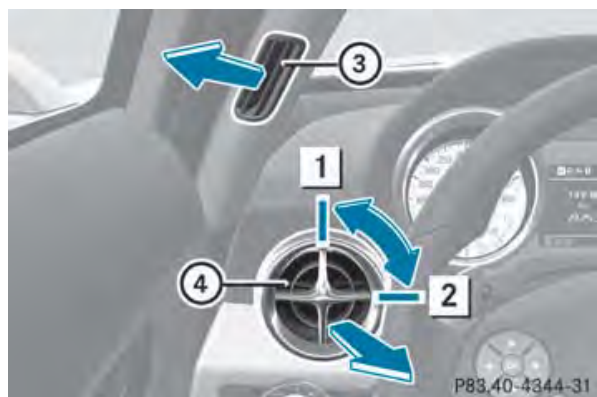

- 1** To open the side air vent
2 To close the side air vent
3 Side window defroster vent
4 Side air vent

- ▶ **To open the side air vent:** turn the adjuster in side air vent ④ in the direction of the arrow to position ①.
- ▶ **To close the side air vent:** turn the adjuster in side air vent ④ in the direction of the arrow to position ②.

Setting the AIRSCARF vents (Roadster)

⚠ WARNING

When operating the climate control, the air that enters the passenger compartment through the air vents can be very hot or very cold (depending on the set temperature). This could cause burns or frostbite to unprotected skin in the immediate area of the air vents.

Always keep sufficient distance between unprotected parts of the body and the air vents. If necessary, use the air distribution adjustment to direct the air to air vents in the vehicle interior that are not in the immediate area of unprotected skin.

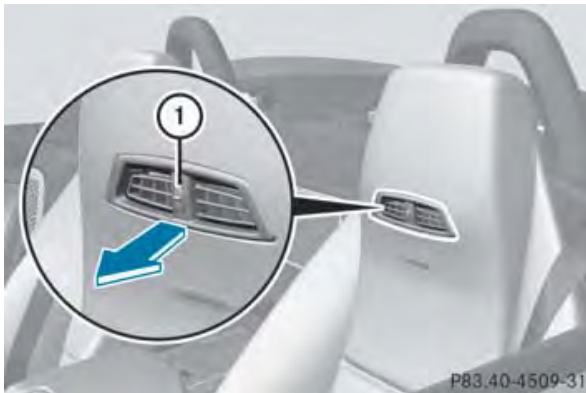

You can adjust the blower output of AIRSCARF vents ① using the AIRSCARF button (▷ page 85).

Useful information	112
Notes on breaking-in a new vehicle	112
Driving	112
AMG SPEEDSHIFT DCT 7-speed sports transmission	117
AMG button (SETUP)	124
Refueling	124
Parking	127
Driving tips	130
Driving systems	134

Useful information

- i** This Operator's Manual describes all models and all standard and optional equipment of your vehicle available at the time of publication of the Operator's Manual. Country-specific differences are possible. Please note that your vehicle may not be equipped with all features described. This also applies to safety-related systems and functions.
- i** Please read the information on qualified specialist workshops (▷ page 22).

Notes on breaking-in a new vehicle

Important safety notes

New brake pads/linings only reach their optimum braking effect after several hundred kilometers of driving. Until that time, you may need to use increased brake pedal pressure while braking. This also applies after the brake discs or the brake pads/linings have been replaced.

The first 1,000 miles (1,500 km)

The more you look after the engine when it is new, the more satisfied you will be with its performance in the future.

- You should therefore drive at varying vehicle and engine speeds for the first 1,000 miles (1,500 km).
- For the first 1,000 miles (1,500 km), do not drive faster than 85 mph (140 km/h).
- Only allow the engine to reach a maximum engine speed of 4,500 rpm briefly.
- Avoid heavy loads, e.g. driving at full throttle, during this period. Do not exceed $\frac{2}{3}$ of the maximum permitted engine speed for each gear.
- Select the manual drive program **M** in good time.
- Do not carry out a RACE START.

- Do not manually shift to a lower gear to brake the vehicle.
- If possible, do not depress the accelerator pedal past the point of resistance (kickdown).
- Only select the shift range limits **3**, **2** or **1** when driving slowly, e.g. in mountainous terrain.

After 1,000 miles (1,500km), you can increase the engine speed gradually and bring the vehicle up to full speed.

- i** You should also observe these breaking-in notes if your vehicle's engine or transmission has been replaced.
- i** Always observe the respective speed limits.

Driving

Important safety notes

WARNING

Objects in the driver's footwell can restrict the pedal travel or obstruct a depressed pedal. The operating and road safety of the vehicle is jeopardized. There is a risk of an accident. Make sure that all objects in the vehicle are stowed correctly, and that they cannot enter the driver's footwell. Install the floormats securely and as specified in order to ensure sufficient clearance for the pedals. Do not use loose floormats.

WARNING

If you switch off the ignition while driving, safety-relevant functions are only available with limitations, or not at all. This could affect, for example, the power steering and the brake boosting effect. You will require considerably more effort to steer and brake. There is a risk of an accident.

Do not switch off the ignition while driving.

- !** Warm up the engine quickly. Do not use the engine's full performance until it has

reached operating temperature. The operating temperature has been reached when the engine oil temperature display in the on-board computer's AMG menu no longer flashes.

Only shift into reverse gear when the vehicle is stationary.

Where possible, avoid spinning the drive wheels when pulling away on slippery roads. You could otherwise damage the drive train.

! During a cold start with low engine oil temperatures (below 32 °F) (0 °C), the maximum engine speed is restricted in order to protect the engine. To protect the engine and maintain smooth engine operation, avoid driving at full throttle when the engine is cold.

Key positions

KEYLESS-GO start function

You can switch the engine on and off with the Start/Stop button. For this, the SmartKey must be inside the vehicle. The Start/Stop button is located in the center console and is illuminated when the vehicle is unlocked.

Pressing the Start/Stop button several times in succession corresponds to the different key positions in the ignition lock. This is only the case if you are not depressing the brake pedal.

If you depress the brake pedal and press the Start/Stop button, the engine starts immediately.

If there is a SmartKey in the ignition lock, this takes precedence over the KEYLESS-GO start function.

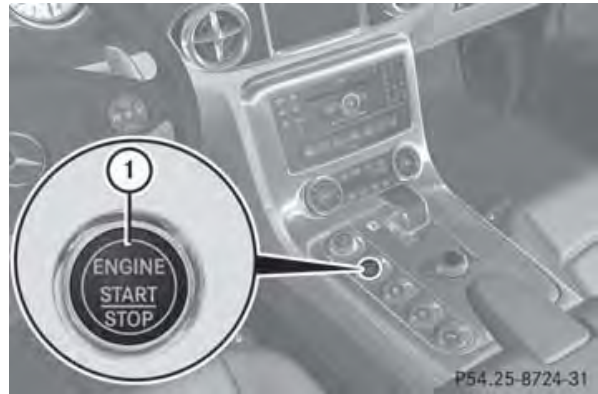

- ▶ Position **0**: if Start/Stop button ① has not yet been pressed, this corresponds to the SmartKey being removed from the ignition.
- ▶ Position **1**: press Start/Stop button ①. You can now activate the windshield wipers, for example.

If you press Start/Stop button ① twice when in this position and the driver's door is open, the power supply is deactivated again.

- ▶ Position **2** (ignition): press Start/Stop button ① twice.

The power supply is switched off again if:

- you press Start/Stop button ① once when in this position
- the driver's door is open

SmartKey

You can also start the vehicle with the SmartKey in the ignition lock.

The ignition lock is located in the rear stowage space of the center console.

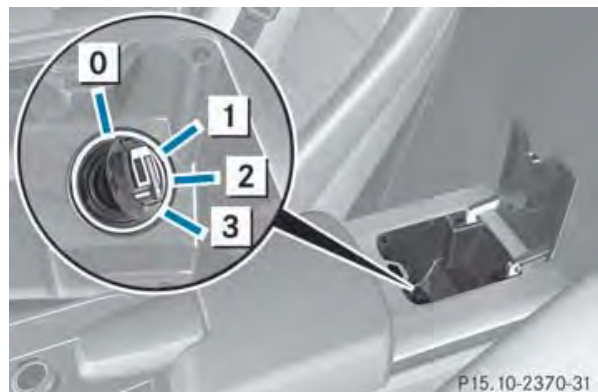

- 0 To remove the SmartKey
 - 1 Power supply for some consumers, such as the windshield wipers
 - 2 Ignition (power supply for all consumers) and drive position
 - 3 To start the engine
- i** The SmartKey can be turned in the ignition lock even if it is not the correct SmartKey for the vehicle. The ignition is not switched on. The engine cannot be started.

Starting the engine

Important safety notes

WARNING

If children are left unsupervised in the vehicle, they could:

- open the doors, thus endangering other people or road users.
- get out and disrupt traffic.
- operate the vehicle's equipment.

Additionally, children could set the vehicle in motion if, for example, they:

- release the parking brake.
- shift the automatic transmission out of parking position P.
- starting the engine.

There is a risk of an accident and injury.

When leaving the vehicle, always take the SmartKey with you and lock the vehicle. Never leave children or animals unattended in the vehicle. Always keep the SmartKey out of reach of children.

WARNING

Combustion engines emit poisonous exhaust gases such as carbon monoxide. Inhaling these exhaust gases leads to poisoning. There is a risk of fatal injury. Therefore never leave the engine running in enclosed spaces without sufficient ventilation.

- i** Do not depress the accelerator pedal when starting the engine.

Starting procedure with the Start/Stop button

- i** The Start/Stop button can be used to start the vehicle without inserting the SmartKey into the ignition lock. You merely need to carry the SmartKey on your person.
- ▶ Depress the brake pedal and keep it depressed.
 - ▶ Press the Start/Stop button (▷ page 113) once.
The engine starts.

Starting procedure with the SmartKey

If the Start/Stop button is inoperative, you can also start the vehicle using the SmartKey in the ignition lock.

- ▶ Turn the SmartKey to position **3** in the ignition lock (▷ page 113) and release it as soon as the engine is running.

Pulling away

AMG SPEEDSHIFT DCT 7-speed sports transmission

WARNING

If the engine speed is above the idling speed and you engage transmission position **D** or **R**, the vehicle could pull away suddenly. There is a risk of an accident.

When engaging transmission position **D** or **R**, always firmly depress the brake pedal and do not simultaneously accelerate.

- i** It is only possible to shift the transmission from position **P** to the desired position, if:
- the engine is running and
 - you depress the brake pedal
- Only then is the parking lock released. If the brake pedal is not depressed, the E-SELECT

lever can still be moved but the parking lock remains engaged.

- ▶ Depress the brake pedal and keep it depressed.
- ▶ Use the E-SELECT lever to shift the transmission to position **D** or **R**.
- ▶ Release the brake pedal.
- ▶ Carefully depress the accelerator pedal. The electric parking brake is automatically released (▷ page 129).
- i** The vehicle locks centrally once you have pulled away. The locking knobs in the doors drop down. The automatic door lock can also be deactivated (Roadster only).

- the vehicle is secured with the electric parking brake.
- ESP[®] is malfunctioning.

Hill start assist

WARNING

After a short time, hill start assist will no longer brake your vehicle and it could roll away. There is a risk of an accident and injury. Therefore, quickly move your foot from the brake pedal to the accelerator pedal. Never leave the vehicle when it is held by hill start assist.

Hill start assist will aid you when pulling away on a hill. It holds the vehicle for a short time after you have removed your foot from the brake pedal. This gives you enough time to move your foot from the brake pedal to the accelerator pedal and depress it before the vehicle begins to roll.

- ▶ Take your foot off the brake pedal.
- i** Once you have taken your foot off the brake pedal, the vehicle is held for around one second.
- ▶ Pull away.

Hill start assist does not function if:

- you are pulling away on a level road or on a downhill gradient.
- the transmission is in position **N**.

Problems with the engine	
Problem	Possible causes/consequences and ► Solutions
The engine does not start. The starter motor can be heard.	<ul style="list-style-type: none"> • There is a malfunction in the engine electronics. • There is a malfunction in the fuel supply. <ul style="list-style-type: none"> ► Turn the SmartKey back to position 0 in the ignition lock before attempting to start the engine again. Alternatively, press the Start/Stop button repeatedly until all indicator lamps in the instrument cluster go out. ► Try to start the engine again (► page 114). Avoid excessively long and frequent attempts to start the engine as these will drain the battery. <p>If the engine does not start after several attempts:</p> <ul style="list-style-type: none"> ► Consult a qualified specialist workshop, e.g. an authorized Mercedes-Benz Center.
The engine does not start. You cannot hear the starter motor.	<p>The on-board voltage is too low because the battery is too weak or discharged.</p> <ul style="list-style-type: none"> ► Jump-start the vehicle (► page 240). <p>If the engine does not start despite attempts to jump-start it:</p> <ul style="list-style-type: none"> ► Consult a qualified specialist workshop, e.g. an authorized Mercedes-Benz Center. <p>The starter motor was exposed to a thermal load that was too high.</p> <ul style="list-style-type: none"> ► Allow the starter motor to cool down for approximately two minutes. ► Try to start the engine again. <p>If the engine still does not start:</p> <ul style="list-style-type: none"> ► Consult a qualified specialist workshop, e.g. an authorized Mercedes-Benz Center.
The engine is not running smoothly and is misfiring.	<p>There is a malfunction in the engine electronics or in a mechanical component of the engine management system.</p> <ul style="list-style-type: none"> ► Only depress the accelerator pedal slightly. ► Have the cause rectified immediately at a qualified specialist workshop, e.g. an authorized Mercedes-Benz Center. Otherwise, non-combusted fuel may get into the catalytic converter and damage it.

Problem	Possible causes/consequences and ► Solutions
<p>The coolant temperature gauge shows a value above 248 °F (120 °C).</p>	<p>The coolant level is too low. The coolant is too hot and the engine is no longer being cooled sufficiently.</p> <ul style="list-style-type: none"> ► Stop as soon as possible and allow the engine and the coolant to cool down. ► Check the coolant level (► page 216). Observe the warning notes as you do so and add coolant if necessary. <p>If the coolant level is correct, the engine radiator fan may be faulty. The coolant is too hot and the engine is no longer being cooled sufficiently.</p> <ul style="list-style-type: none"> ► At coolant temperatures under 248 °F (120 °C), drive on to the nearest qualified specialist workshop, e.g. to an authorized Mercedes-Benz Center. ► Avoid heavy loads on the engine as you do so, e.g. driving in mountainous terrain and start/stop traffic.

AMG SPEEDSHIFT DCT 7-speed sports transmission

Important safety notes

⚠ WARNING

If the engine speed is above the idling speed and you engage transmission position **D** or **R**, the vehicle could pull away suddenly. There is a risk of an accident.

When engaging transmission position **D** or **R**, always firmly depress the brake pedal and do not simultaneously accelerate.

Observe the "Important safety notes" section on activating/deactivating ESP® (► page 56).

E-SELECT selector lever

Overview of transmission positions

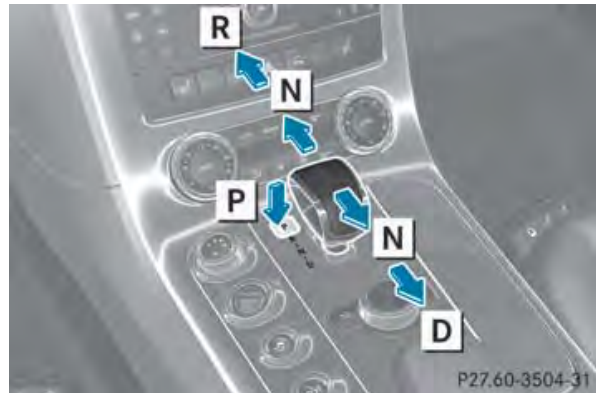

- P** Park position with parking lock
- R** Reverse gear
- N** Neutral
- D** Drive

! If the engine speed is too high or if the vehicle is rolling, do not shift the transmission directly from **D** to **R**, from **R** to **D** or directly to **P**.

Do not open the driver's door while the vehicle is in motion. At low speeds in transmission position **D** or **R**, park position **P** is otherwise engaged automatically.

The transmission could be damaged.

- i** The E-SELECT lever always returns to its original position.

The current transmission position **P**, **R**, **N** or **D** appears in the transmission position display in the multifunction display.

If you wish to select a transmission position or to disengage park position **P**, the engine must be running.

Engaging park position **P**

- ▶ When the vehicle is stationary, depress the brake pedal.
- ▶ Press the **P** button in the center console.

- i** Park position **P** is disengaged if you:

- depress the brake pedal and
- push the E-SELECT lever forwards or back to the first point of resistance

The transmission shifts to neutral **N**.

To shift directly from **P** to **R**:

- ▶ Depress the brake pedal and push the E-SELECT lever forwards past the first point of resistance.

To shift directly from **P** to **D**:

- ▶ Depress the brake pedal and push the E-SELECT lever back past the first point of resistance.

Engaging park position **P** automatically

Park position is engaged automatically in the following circumstances:

- if you switch off the engine using the Start/Stop button and open the driver's or front-passenger door.
- if you remove the SmartKey from the ignition lock.
- if you open the door while traveling at low speed in transmission position **D** or **R**.

Shifting to neutral **N**

- ▶ When the vehicle is stationary, depress the brake pedal.
- ▶ Push the E-SELECT lever forwards or back to the first point of resistance.

- i** If you use the E-SELECT lever to shift the transmission to **N** before switching off the engine, the transmission remains for approximately 30 minutes in **N**. If you open the driver's or front-passenger door during this period, the transmission automatically shifts to **P**.

The transmission remains in **N** if:

- the SmartKey is in the ignition lock and
- you use the E-SELECT lever to shift the transmission to **N** before switching the engine off

This still applies if you open the driver's or front-passenger door.

Further information is available in the "Car wash" section (▶ page 219).

Engaging reverse gear **R**

- ▶ When the vehicle is stationary, depress the brake pedal.
- ▶ Push the E-SELECT lever forward past the first point of resistance.

Shifting to transmission position **D**

- ▶ When the vehicle is stationary, depress the brake pedal.
- ▶ Push the E-SELECT lever back past the first point of resistance.

Transmission position and drive program display

Display in transmission positions P, R and N



- ① Transmission position: currently selected transmission position is displayed in inverted colors
- ② Drive program (C/S/S+/M)

In addition to drive program ② being shown in the multifunction display, the currently selected drive program is indicated in red on the drive program selector switch.

Display when in transmission position D



- ① Transmission position
- ② Gear
- ③ Drive program (C/S/S+)

If you have restricted the shift range, the transmission position and the selected shift range, e.g. D3, are shown at position ①.

Display when in transmission position D and drive program M

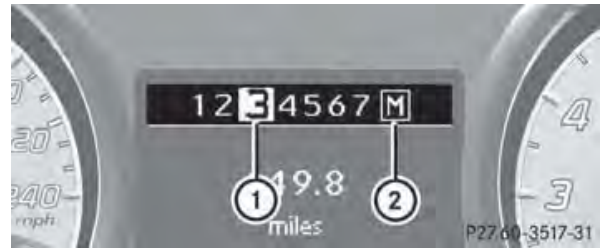

- ① Gear
- ② Drive program

Transmission positions

P

Park position

Do not shift the transmission into position **P** unless the vehicle is stationary. The parking lock should not be used as a brake when parking. Always apply the electronic parking brake in addition to the parking lock in order to secure the vehicle.

In the event of a malfunction of the vehicle's electronics, the transmission may lock in position **P**.

Have the vehicle electronics checked at a qualified specialist workshop, e.g. an authorized Mercedes-Benz Center, immediately.

R

Reverse gear

Only shift the transmission to **R** when the vehicle is stationary.

N	<p>Neutral</p> <p>No power is transmitted from the engine to the drive wheels. Releasing the brakes will allow you to move the vehicle freely, e.g. to push it.</p> <p>Do not shift the transmission to N while driving. The transmission could otherwise be damaged.</p> <p>If ESP® is deactivated or faulty: only shift the transmission to position N if the vehicle is in danger of skidding, e.g. on icy roads.</p>
D	<p>Drive</p> <p>The transmission shifts into drive programs (C/S/S+) automatically. All forward gears are available.</p>

Changing gear

The transmission shifts into individual gears automatically. This is determined by:

- drive position **D**
- the selected drive program (**C/S/S+**)
- the position of the accelerator pedal
- the road speed
- a shift range restriction, if selected

The shift points primarily depend on:

- the position of the accelerator pedal: little throttle: early upshifts; high throttle: late upshifts
- the driving dynamics

A dynamic driving style with high longitudinal and lateral acceleration delays the shift points to higher engine speeds.

Driving tips

Double-clutch function

When shifting down, the double-clutch function is active regardless of the currently selected drive program. The double-clutch

function reduces the load change reaction on the drive axle. The sound generated by the double-clutch function and its characteristics depend on the drive program selected.

Kickdown

i Kickdown is not available in manual drive program **M**.

Use kickdown for maximum acceleration:

- ▶ Depress the accelerator pedal beyond the pressure point. Depending on the selected drive program, the transmission shifts to the lowest gear allowing ideal acceleration.

Drive program selector

With the drive program selector switch, you can choose from a range of different transmission configurations or select the RACE START drive mode.

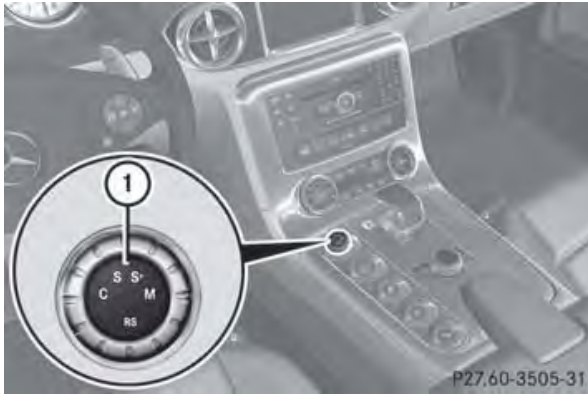

Drive program	Characteristic
C Controlled Efficiency	Comfort-oriented, optimum-economy engine and transmission settings
S Sport	Sporty engine and transmission settings
S+ SportPlus	Extremely sporty engine and transmission settings
M Manual	Manual gear shifting

Drive program	Characteristic
Driving mode	
RS RACE START	Optimal vehicle acceleration from a standstill

► Turn drive program selector switch ① until the desired drive program is shown in the multifunction display.

i **RS** cannot be selected during normal driving. For further information on RACE START, see (▷ page 121).

Steering wheel paddle shifters

In transmission position **D**, you can use the steering wheel paddle shifters to restrict or derestrict the transmission shift range. One of the automatic drive programs, **C**, **S** or **S+**, must be selected in order to do so.

In manual drive program **M**, you need to change gear yourself using the steering wheel paddle shifters. At low engine speeds, the transmission shifts down automatically.

i **GT model:** in manual drive program **M**, the transmission shift and response times are significantly shorter with sportier and more aggressive gear changes.



- ① Left steering wheel paddle shifter (DOWN): shift down/restrict shift range
- ② Right steering wheel paddle shifter (UP): shift up/derestrict shift range

RACE START

RACE START enables optimal acceleration from a standing start under suitable high-grip road surface conditions.

RACE START is intended solely for activation on dedicated race circuits.

Conditions for activation

You can activate RACE START if:

- the doors are closed
- the engine is running and the engine and transmission are at operating temperature (▷ page 157)
- SPORT handling mode is switched on (▷ page 56)
- the steering wheel is in the straight-ahead position
- the vehicle is stationary and the brake pedal is depressed (left foot)
- the transmission is set to **D**

Activating RACE START

► Depress the brake pedal with your left foot and keep it depressed.

► Turn the drive program selector switch clockwise (▷ page 120) until the **RS** indicator on the switch lights up in red. The multifunction display shows the message **RACE START Confirm: Paddle UP** **Cancel: Paddle DOWN**.

i If the conditions for activation are not fulfilled, RACE START is canceled. The **RACE START Not Possible** message appears in the multifunction display.

► **To cancel:** pull the left-hand steering wheel paddle shifter (DOWN) (▷ page 121). The multifunction display shows the **RACE START Canceled** message.

► **To confirm:** pull the right-hand steering wheel paddle shifter (UP) (▷ page 121). The **RACE START Available Depress gas pedal** message appears in the multifunction display.

P27.60-3381-31

i If you do not depress the accelerator pedal within a few seconds, RACE START is canceled. The multifunction display shows the **RACE START Canceled** message.

► Fully depress the accelerator pedal. The engine speed is increased. The **RACE START Release brake to start** message appears in the multifunction display.

i If you do not release the brake pedal within a few seconds, RACE START is canceled. The multifunction display shows the **RACE START Canceled** message.

► Take your foot off the brake pedal while keeping the accelerator pedal fully depressed. The vehicle pulls away at maximum acceleration. The **RACE START Active** message appears in the multifunction display.

RACE START is deactivated when the vehicle reaches a speed of approximately 50 km/h. Drive program **S+** is activated. SPORT handling mode remains switched on.

RACE START is deactivated immediately if you release the accelerator pedal during RACE START or if any of the activation conditions are no longer fulfilled. The **RACE START Not Possible** or **RACE START Canceled** message appears in the multifunction display.

i If RACE START is used repeatedly within a short period of time, it is only available again after the vehicle has been driven a certain distance.

Automatic drive program

Drive program **C** is characterized by the following:

- comfort-oriented engine and transmission settings
- optimal fuel consumption resulting from the transmission shifting up sooner

- the vehicle pulling away more gently in forward and reverse gears, unless the accelerator pedal is depressed fully
- increased sensitivity. This improves driving stability on slippery road surfaces, for example
- the transmission shifting up sooner; This results in the vehicle being driven at lower engine speeds and the wheels being less likely to spin

Drive programs **S** and **S+** are characterized by the following:

- sporty engine and transmission settings
- the transmission shifting up later and shifting down dynamically
- as a result of the later transmission upshifts, the fuel consumption may be higher
- if a period of dynamic driving is followed by an extended phase with a constant accelerator pedal position, the vehicle shifts up to a higher gear. This optimizes fuel consumption

If a gentle driving style is adopted in automatic drive programs C/S/S+, the drive program settings are adjusted to optimize fuel consumption. Depending on the operating conditions, the transmission shifts to a higher gear.

Shift ranges

Introduction

In certain driving situations, it is recommended that you restrict the shift range. The set shift range appears in the instrument cluster's multifunction display (▷ page 119). The transmission only shifts to the gear displayed in the instrument cluster.

When the maximum engine speed is reached, the transmission shifts up a gear in the automatic programs C/S/S+. Gear restriction is correspondingly increased by one gear.

	Driving situation
3	The braking effect of the engine can be utilized in this position
2	You can use the braking effect of the engine on downhill gradients and for driving: <ul style="list-style-type: none"> • on steep mountain roads • in mountainous terrain • in arduous conditions
1	To use the braking effect of the engine on extremely steep downhill gradients and on long downhill stretches

Derestricting the shift range/shifting up

- ▶ Pull the right steering wheel paddle (UP). The shift range is derestricted. If you are driving in manual drive program **M**, the transmission shifts up to the next gear.

Restricting the shift range/shifting down

- ▶ Pull the left steering wheel paddle (DOWN). The transmission shifts down one gear and restricts the shift range to this gear. If the engine speed in manual drive program **M** is too high, it is not possible to shift down. If you pull the left-hand steering wheel paddle shifter (DOWN) (▷ page 124), the two red segments in the instrument cluster flash.

Clearing the shift range restriction

- ▶ Pull the right-hand steering wheel paddle shifter (UP) until the number for the gear disappears from the multifunction display.
- or
- ▶ Use the E-SELECT lever to shift the transmission to position **D**. The transmission shifts from the current shift range directly to **D**.

Selecting the ideal shift range

- ▶ Pull the left-hand steering wheel paddle shifter repeatedly until the function is activated. Depending on the selected drive program, the transmission shifts to a gear which allows ideal acceleration and deceleration. To do this, the transmission shifts down one or more gears.

Manual drive program

- i** **GT model:** in manual drive program **M**, the transmission shift and response times are significantly shorter with sportier and more aggressive gear changes.

In manual drive program **M**, you need to change gear yourself using the steering wheel paddle shifters (▷ page 121). The transmission only shifts down automatically at low engine speeds depending on the respective gear.

- !** In manual drive program **M**, the transmission does not shift up automatically even when the engine limiting speed for the current gear is reached. When the engine limiting speed is reached, the fuel supply is cut to prevent the engine from overrevving. Always make sure that the engine speed does not reach the red area of the tachometer and observe the upshift indicator. There is otherwise a risk of engine damage.

- ▶ **To activate the manual drive program:** turn the drive program selector switch until **M** appears in the instrument cluster's multifunction display. **M** lights up in red on the drive program selector switch.
- ▶ **To deactivate the manual drive program:** turn the drive program selector switch and select another drive program.

Upshift indicator

The upshift indicator is a four-stage display designed to assist you in sporty driving.



The upshift indicator allows you to recognize the ideal shift point for dynamic acceleration. White segments ① and yellow segment ② light up in succession from left to right.

When red segments ③ light up and the "up" message appears in the multifunction display, the ideal shift point has been reached:

- Shift up using the right-hand steering wheel paddle shifter (UP) as quickly as possible. The vehicle shifts up to the next gear.

i If you continue to increase the engine speed without shifting up in time, the fuel supply is shut off to protect the engine. This results in abruptly reduced acceleration.

Display for downshift override

If the engine speed is too high, you cannot shift down with the left steering wheel paddle shifter. If you then pull the left steering wheel paddle shifter, both red segments ③ light up briefly.

AMG button (SETUP)

With the AMG button, you can call up and store a default drive program setting and the default suspension tuning.



- **To store:** press and hold AMG button ① until you hear a tone.
- **To call up:** press AMG button ①. The stored drive program is selected.
- **To display:** briefly press AMG button ①. The multifunction display shows the SETUP in the AMG menu (► page 157).

Refueling

Important safety notes

⚠ WARNING

Fuel is highly flammable. If you handle fuel incorrectly, there is a risk of fire and explosion.

You must avoid fire, open flames, creating sparks and smoking. Switch off the engine and, if applicable, the auxiliary heating before refueling.

⚠ WARNING

Fuel is poisonous and hazardous to health. There is a risk of injury.

You must make sure that fuel does not come into contact with your skin, eyes or clothing and that it is not swallowed. Do not inhale fuel vapors. Keep fuel away from children.

If you or others come into contact with fuel, observe the following:

- Wash away fuel from skin immediately using soap and water.
- If fuel comes into contact with your eyes, immediately rinse them thoroughly with

clean water. Seek medical assistance without delay.

- If fuel is swallowed, seek medical assistance without delay. Do not induce vomiting.
- Immediately change out of clothing which has come into contact with fuel.

WARNING

Electrostatic buildup can create sparks and ignite fuel vapors. There is a risk of fire and explosion.

Touch the vehicle body immediately before opening the fuel filler cap. Any existing electrostatic buildup is thereby discharged.

! Do not use diesel to refuel vehicles with a gasoline engine. Do not switch on the ignition if you accidentally refuel with the wrong fuel. Otherwise, the fuel will enter the fuel system. Even small amounts of the wrong fuel could result in damage to the fuel system and the engine. The repair costs are high. Notify a qualified specialist workshop and have the fuel tank and fuel lines drained completely.

! Overfilling the fuel tank could damage the fuel system.

! Take care not to spill any fuel on painted surfaces. You could otherwise damage the paintwork.

! Use a filter when refueling from a fuel can. Otherwise, the fuel lines and/or injection system could be blocked by particles from the fuel can.

If you overfill the fuel tank, fuel could spray out when the fuel pump nozzle is removed. Further information on fuel and on fuel grades can be found in the "Fuel" section (▷ page 277).

Refueling

Fuel filler flap

When you open or close the vehicle with the SmartKey, the fuel filler flap is automatically unlocked or locked.

The fuel filler flap is located to the rear on the right. The position of the fuel filler cap is displayed in the instrument cluster . The arrow next to the filling pump indicates the side of the vehicle.

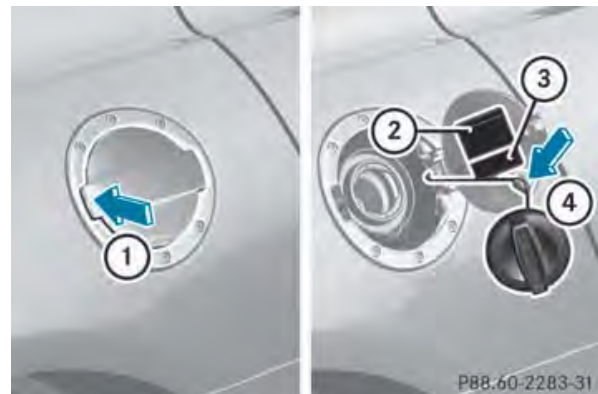

- ① To open the fuel filler flap
- ② Tire pressure table
- ③ Fuel type
- ④ To insert the fuel filler cap

Opening

► Switch off the engine.

i When the engine is running and the fuel filler flap is open, the engine diagnostics warning lamp  may light up.

Further information can be found in the "Warning and indicator lamps in the instrument cluster" chapter (▷ page 191).

► Open the driver's door. This switches the ignition to position **0**, which corresponds to having removed the SmartKey. The driver's door can be closed again.

► Press the fuel filler flap in the direction of arrow ①.

The fuel filler flap opens slightly.

► Open the fuel filler flap.

- ▶ Turn the fuel filler cap counter-clockwise and remove it.
 - ▶ Insert the fuel filler cap into the holder bracket on the inside of filler flap ④.
 - ▶ Completely insert the fuel pump nozzle into the filler neck and refuel.
 - ▶ Only fill the tank until the pump nozzle switches off.
- !** Overfilling the fuel tank could damage the fuel system.

Closing

- ▶ Replace the fuel filler cap and turn it clockwise. The fuel filler cap audibly engages.
- ▶ Close the fuel filler flap.

Problems with fuel and the fuel tank

Problem	Possible causes/consequences and ► Solutions
Fuel is leaking from the vehicle.	<p> Risk of explosion or fire</p> <p>The fuel line or the fuel tank is defective.</p> <ul style="list-style-type: none"> ► Set the Start/Stop button to key position 0 immediately. ► Do not restart the engine under any circumstances. ► Consult a qualified specialist workshop.
The fuel filler flap cannot be opened.	<p>The fuel filler flap is not unlocked. or The SmartKey battery is discharged.</p> <ul style="list-style-type: none"> ► Unlock the vehicle (▷ page 67). or ► Unlock the vehicle using the mechanical key (▷ page 69). <p>The fuel filler flap is unlocked, but the opening mechanism is jammed.</p> <ul style="list-style-type: none"> ► Consult a qualified specialist workshop.

Parking

Important safety notes

 **WARNING**

If flammable materials such as leaves, grass or twigs are exposed to prolonged contact to parts of the exhaust system that heat up, they could ignite. There is a risk of fire.

Park the vehicle so that no flammable materials come into contact with parts of the vehicle which are hot. Take particular care not to park on dry grassland or harvested grain fields.

 **WARNING**

If you leave children unsupervised in the vehicle, they could set it in motion by, for example:

- releasing the parking brake
- shifting the automatic transmission out of the parking position **P**
- starting the engine.

They could also operate the vehicle's equipment. There is a risk of an accident and injury.

When leaving the vehicle, always take the SmartKey with you and lock the vehicle. Never leave children unsupervised in the vehicle.

 If the engine speed is too high or if the vehicle is rolling, do not shift the transmission directly from **D** to **R**, from **R** to **D** or directly to **P**.

Do not open the driver's door while the vehicle is in motion. At low speeds in transmission position **D** or **R**, park position **P** is otherwise engaged automatically.

The transmission could be damaged.

 Always secure the vehicle correctly against rolling away. Otherwise, the vehicle or its drivetrain could be damaged.

To ensure that the vehicle is secured against rolling away unintentionally:

- the electric parking brake must be applied.
- the transmission must be in position **P**.
- the SmartKey must be in position **O** in the ignition lock and then removed from the ignition lock, or the Start/Stop button must be pressed.
- on steep uphill or downhill gradients, turn the front wheels towards the curb.
- on steep uphill or downhill gradients, the front axle of an empty vehicle must be secured, for example with a wheel chock.
- on steep uphill or downhill gradients, the rear axle of a laden vehicle must be additionally secured, for example with a wheel chock.

Switching off the engine

Important safety notes

WARNING

When the engine is switched off, the transmission shifts into neutral position **N**. The vehicle may roll away. There is a risk of an accident.

After switching off the engine, always switch to parking position **P**. Prevent the parked vehicle from rolling away by applying the parking brake.

- ❗ Do not open the driver's door while the vehicle is in motion. At low speeds in transmission position **D** or **R**, park position **P** is otherwise engaged automatically. This can damage the transmission.
- i Observe the display messages in the instrument cluster.

AMG SPEEDSHIFT DCT 7-speed sports transmission

- ▶ Shift the transmission to **P** with the button in the center console.

Using the Start/Stop button

- ▶ Press the Start/Stop button (▷ page 113). The engine stops and all the indicator lamps in the instrument cluster go out.
- ▶ Apply the electric parking brake.

i If you switch the engine off with the transmission in position **R** or **D**, the transmission automatically shifts to **N**.

If you move the E-SELECT lever to **N** before switching off the engine, the transmission remains for approximately 30 minutes in **N**.

If you open the driver's or front-passenger door during this period, the transmission automatically shifts to **P**.

i The engine can be turned off while the vehicle is in motion by pressing and holding the Start/Stop button for about three seconds.

Using the SmartKey

❗ Do not remove the SmartKey while the vehicle is in motion. At low speeds, park position **P** will otherwise be engaged automatically.

Do not open the driver's door while the vehicle is in motion. At low speeds, transmission position **P** is engaged automatically.

This can damage the transmission.

- ▶ Turn the SmartKey to position **O** in the ignition lock and remove it. The parking lock is activated.
- ▶ Apply the electric parking brake.

i If you move the E-SELECT lever to **N** before switching off the engine, the transmission remains for approximately 30 minutes in **N**. If you open the driver's or front-passenger door during this period, the transmission automatically shifts to **P**.

The transmission remains in **N** if:

- the SmartKey is in the ignition lock and
- you use the E-SELECT lever to shift the transmission to **N** before switching the engine off

This still applies if you open the driver's or front-passenger door.

Further information on transmission position **N** when operating with a SmartKey is available in the "Car wash" section (▷ page 219).

Electric parking brake

General notes

WARNING

If you leave children unsupervised in the vehicle, they could set it in motion by, for example:

- releasing the parking brake
- shifting the automatic transmission out of the parking position **P**
- starting the engine.

They could also operate the vehicle's equipment. There is a risk of an accident and injury.

When leaving the vehicle, always take the SmartKey with you and lock the vehicle. Never leave children unsupervised in the vehicle.



Applying/releasing manually

- ▶ **To engage:** push handle ①.

When the electric parking brake is engaged, the red **PARK** (USA only) or **(P)** (Canada only) indicator lamp lights up in the instrument cluster.

- i** The electric parking brake can also be applied when the SmartKey is in position **0**.

- ▶ Pull handle ①.

The red **PARK** (USA only) or **(P)** (Canada only) indicator lamp in the instrument cluster goes out.

- i** The electric parking brake can only then be released when the ignition is switched on using the Start/Stop button.

Releasing the electric parking brake automatically

The electric parking brake is released automatically when the following conditions are simultaneously fulfilled:

- the engine is running.
- the transmission is in position **D** or **R**.
- the hood is closed.
- your seat belt is fastened.
- you accelerate.

If the transmission is in position **R**, the trunk lid must be closed.

For the parking brake to be released automatically if your seat belt is not fastened, the following conditions must be fulfilled:

- the driver's door is closed.
- you have shifted out of **P** or you have previously driven faster than 2 mph (3 km/h).

Emergency braking

The vehicle can also be braked during an emergency by using the electric parking brake.

- ▶ While driving, push handle ① of the electric parking brake (▷ page 129).

- i** The vehicle is braked as long as you keep the handle of the electric parking brake pressed. The longer the electric parking brake handle is depressed, the greater the braking force.

During braking:

- a warning tone sounds.
- the **Release Parking Brake** message appears
- the red **PARK** (USA only) or **(P)** (Canada only) indicator lamp in the instrument cluster appears.

When the vehicle has been braked to a standstill, the electric parking brake is engaged.

Parking the vehicle for a long period

If you leave the vehicle parked for longer than four weeks, the battery may be damaged by exhaustive discharging.

If you leave the vehicle parked up for longer than six weeks, the vehicle may suffer damage as a result of lack of use.

- ▶ Visit a qualified specialist workshop and seek advice.

- i** You can obtain information about trickle chargers from a qualified specialist workshop.

Driving tips

General driving tips

Important safety notes

WARNING

If you switch off the ignition while driving, safety-relevant functions are only available with limitations, or not at all. This could affect,

for example, the power steering and the brake boosting effect. You will require considerably more effort to steer and brake. There is a risk of an accident.

Do not switch off the ignition while driving.

WARNING

Please do not forget that your primary responsibility is to drive the vehicle. A driver's attention to the road must always be his/her primary focus when driving. For your safety and the safety of others, we recommend that you pull over to a safe location and stop before placing or taking a telephone call.

If you choose to use the telephone⁵ while driving, please use the hands-free device and only use the telephone when road, weather and traffic conditions permit. Some jurisdictions prohibit the driver from using a mobile telephone while driving a vehicle.

Only operate the COMAND⁵ (Cockpit Management and Data System) if road, weather and traffic conditions permit. Otherwise, you may not be able to observe traffic conditions and could endanger yourself and others.

Bear in mind that at a speed of just 30 mph (approximately 50 km/h), your vehicle is covering a distance of 44 feet (approximately 14 m) every second.

Drive sensibly – save fuel

Observe the following tips to save fuel:

- ▶ The tires should always be inflated to the recommended tire pressure.
- ▶ Remove unnecessary loads.
- ▶ Warm up the engine at low engine speeds.
- ▶ Avoid frequent acceleration or braking.
- ▶ Have all maintenance work carried out according to the service intervals listed in the Maintenance Booklet or the service interval display.

⁵ Observe all legal requirements.

Fuel consumption also increases when driving in cold weather, in stop-start traffic and in hilly terrain.

Drinking and driving

WARNING

Drinking and driving and/or taking drugs and driving are very dangerous combinations. Even a small amount of alcohol or drugs can affect your reflexes, perceptions and judgment.

The possibility of a serious or even fatal accident are greatly increased when you drink or take drugs and drive.

Do not drink or take drugs and drive or allow anyone to drive who has been drinking or taking drugs.

Emission control

WARNING

Combustion engines emit poisonous exhaust gases such as carbon monoxide. Inhaling these exhaust gases leads to poisoning. There is a risk of fatal injury. Therefore never leave the engine running in enclosed spaces without sufficient ventilation.

Certain engine systems are designed to keep the level of poisonous components in exhaust fumes within legal limits.

These systems only work at peak efficiency if they are serviced exactly in accordance with the manufacturer's specifications. For this reason, all work on the engine must be carried out by qualified and authorized Mercedes-Benz technicians.

The engine settings must not be changed under any circumstances. Furthermore, all specific service work must be carried out at regular intervals and in accordance with the Mercedes-Benz service requirements. Details can be found in the Maintenance Booklet.

Braking

Important safety notes

WARNING

If you shift down on a slippery road surface in an attempt to increase the engine's braking effect, the drive wheels could lose their grip. There is an increased danger of skidding and accidents.

Do not shift down for additional engine braking on a slippery road surface.

Downhill gradients

! On long and steep gradients, you must reduce the load on the brakes by shifting early to a lower gear. This allows you to take advantage of the engine braking effect and helps avoid overheating and excessive wear of the brakes.

When you take advantage of the engine braking effect, a drive wheel may not turn for some time, e.g. on a slippery road surface. This could cause damage to the drive train. This type of damage is not covered by the Mercedes-Benz warranty.

Heavy and light loads

WARNING

If you rest your foot on the brake pedal while driving, the braking system can overheat. This increases the stopping distance and can even cause the braking system to fail. There is a risk of an accident.

Never use the brake pedal as a footrest. Never depress the brake pedal and the accelerator pedal at the same time.

! Depressing the brake pedal constantly results in excessive and premature wear to the brake pads.

If the brakes have been subjected to a heavy load, do not stop the vehicle immediately. Drive on for a short while. This allows the airflow to cool the brakes more quickly.

Wet roads

If you have driven for a long time in heavy rain without braking, there may be a delayed reaction from the brakes when braking for the first time. This may also occur after the vehicle has been washed or driven through deep water.

You have to depress the brake pedal more firmly. Maintain a greater distance from the vehicle in front.

After driving on a wet road or having the vehicle washed, brake firmly while paying attention to the traffic conditions. This will warm up the brake discs, thereby drying them more quickly and protecting them against corrosion.

Limited braking performance on salt-treated roads

If you drive on salted roads, a layer of salt residue may form on the brake discs and brake pads. This can result in a significantly longer braking distance.

- Brake occasionally to remove any possible salt residue. Make sure that you do not endanger other road users when doing so.
- Carefully depress the brake pedal and the beginning and end of a journey.
- Maintain a greater distance to the vehicle ahead.

Servicing the brakes

! If the red brake warning lamp lights up in the instrument cluster and you hear a warning tone while the engine is running, the brake fluid level may be too low. Observe additional warning messages in the multifunction display.

The brake fluid level may be too low due to brake pad wear or leaking brake lines.

Have the brake system checked immediately. This work should be carried out at an authorized Mercedes-Benz Center.

! As the ESP[®] system operates automatically, the engine and the ignition must be switched off (the SmartKey must be in position **0** or **1** in the ignition lock or the Start/Stop button must be in position **0** or **1**) if:

- the electric parking brake is tested using a brake dynamometer.
- the vehicle is towed with one axle raised.

Braking triggered automatically by ESP[®] may seriously damage the brake system.

All checks and maintenance work on the brake system must be carried out at a qualified specialist workshop. Have this work carried out at an authorized Mercedes-Benz Center.

Have the brake pads replaced and the brake fluid renewed at a qualified specialist workshop, e.g. an authorized Mercedes-Benz Center.

If the brake system has only been subject to moderate loads, you should test the functionality of your brakes at regular intervals. To do so, press firmly on the brake pedal when driving at a high speed. This improves the grip of the brake pads.

You can find a description of Brake Assist (BAS) on (▷ page 55).

Mercedes-Benz recommends that you only have brake pads/linings installed on your vehicle which have been approved for Mercedes-Benz vehicles or which correspond to an equivalent quality standard. Brake pads/linings which have not been approved for Mercedes-Benz vehicles or which are not of an equivalent quality could affect your vehicle's operating safety.

Mercedes-Benz recommends that you only use brake fluid that has been specially approved for your vehicle by Mercedes-Benz, or which corresponds to an equivalent quality standard. Brake fluid which has not been approved for Mercedes-Benz vehicles or which is not of an equivalent quality could affect your vehicle's operating safety.

AMG high-performance composite brake system

The AMG high-performance compound brake system and the AMG ceramic high-performance compound brake system are designed for high loads. This may lead to noise when braking. This will depend on:

- Speed
- Braking force
- Environmental conditions, such as temperature and humidity

The wear of individual components of the brake system, such as the brake pads/linings or brake discs, depends on the individual driving style and operating conditions.

For this reason, it is impossible to state a mileage that will be valid under all circumstances. An aggressive driving style will lead to high wear. You can obtain further information about this from your authorized Mercedes-Benz Center.

New and replaced brake pads and discs only reach their optimum braking effect after several hundred kilometers of driving. Compensate for this by applying greater force to the brake pedal. Keep this in mind, and adapt your driving and braking accordingly during this break-in period.

Excessive heavy braking results in correspondingly high brake wear. Observe the brake wear warning lamp in the instrument cluster and note any brake status messages in the multifunction display. Especially for high performance driving, it is important to maintain and have the brake system checked regularly.

Driving on wet roads

Hydroplaning

If water has accumulated to a certain depth on the road surface, there is a danger of hydroplaning occurring, even if:

- you drive at low speeds.
- the tires have adequate tread depth.

For this reason, in the event of heavy rain or in conditions in which hydroplaning may occur, you must drive in the following manner:

- lower your speed.
- avoid ruts.
- brake carefully.

Driving on flooded roads

- ❗ Do not drive through flooded areas. Check the depth of any water before driving through it. Drive slowly through standing water. Otherwise, water may enter the vehicle interior or the engine compartment. This can damage the electronic components in the engine or the automatic transmission. Water can also be drawn in by the engine's air suction nozzles and this can cause engine damage.

Winter driving

Points to remember

WARNING

If you shift down on a slippery road surface in an attempt to increase the engine's braking effect, the drive wheels could lose their grip. There is an increased danger of skidding and accidents.

Do not shift down for additional engine braking on a slippery road surface.

DANGER

If the exhaust pipe is blocked or adequate ventilation is not possible, poisonous gases

such as carbon monoxide (CO) may enter the vehicle. This is the case, e.g. if the vehicle becomes trapped in snow. There is a risk of fatal injury.

If you leave the engine or the auxiliary heating running, make sure the exhaust pipe and area around the vehicle are clear of snow. To ensure an adequate supply of fresh air, open a window on the side of the vehicle that is not facing into the wind.

At the onset of winter, have your vehicle winterized at a qualified specialist workshop, e.g. at an authorized Mercedes-Benz Center. Observe the notes in the "Winter operation" section (▷ page 250).

Summer tires

Observe the notes in the "Winter operation" section (▷ page 250).

Slippery road surfaces

WARNING

If you shift down on a slippery road surface in an attempt to increase the engine's braking effect, the drive wheels could lose their grip. There is an increased danger of skidding and accidents.

Do not shift down for additional engine braking on a slippery road surface.

Drive particularly carefully on slippery road surfaces. Avoid sudden acceleration, steering and braking maneuvers. Do not use cruise control.

If the vehicle threatens to skid or cannot be stopped when moving at low speed:

- ▶ Shift the transmission to position **N**.

The outside temperature indicator is not designed to serve as an ice-warning device and is therefore unsuitable for that purpose. Changes in the outside temperature are displayed after a short delay.

Indicated temperatures just above the freezing point do not guarantee that the road

surface is free of ice. The road may still be icy, especially in wooded areas or on bridges. You should pay special attention to road conditions when temperatures are around freezing point.

- i** For more information on driving with snow chains, see (▷ page 250).

Driving systems

Cruise control

Important safety notes

Cruise control maintains a constant road speed for you. It brakes automatically in order to avoid exceeding the set speed. On long and steep downhill gradients, especially if the vehicle is laden, you must select shift range **1**, **2** or **3** in good time (▷ page 122). By doing so, you will make use of the braking effect of the engine. This relieves the load on the brake system and prevents the brakes from overheating and wearing too quickly.

If you fail to adapt your driving style, cruise control can neither reduce the risk of an accident nor override the laws of physics. Cruise control cannot take into account the road, traffic and weather conditions. Cruise control is only an aid. You are responsible for the distance to the vehicle in front, for vehicle speed, for braking in good time and for staying in lane.

Use cruise control only if road and traffic conditions make it appropriate to maintain a steady speed for a prolonged period. You can set any road speed above 20 mph (30 km/h).

Do not use cruise control:

- in road and traffic conditions which do not allow you to maintain a constant speed, e.g. in heavy traffic or on winding roads
- on slippery road surfaces. Braking or accelerating could cause the drive wheels

to lose traction and the vehicle could then skid

- when there is poor visibility, e.g. due to fog, heavy rain or snow

If there is a change of drivers, advise the new driver of the speed stored.

Cruise control lever

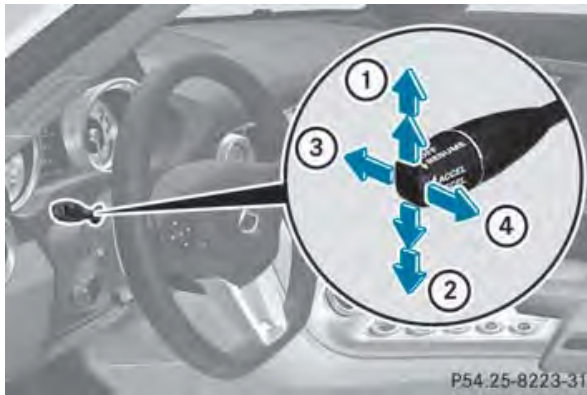

- ① To store the current speed or a higher speed
- ② To store the current speed or a lower speed
- ③ To deactivate cruise control
- ④ To store the current speed or call up the last stored speed

When you activate cruise control, the stored speed is shown in the lower section of the multifunction display.

Storing and maintaining the current speed

You can store the current speed if you are driving faster than 20 mph (30 km/h).

- ▶ Accelerate the vehicle to the desired speed.
- ▶ Briefly press the cruise control lever up ① or down ② to the pressure point.
- ▶ Remove your foot from the accelerator pedal.
Cruise control is activated. The vehicle automatically maintains the stored speed.

i Cruise control may be unable to maintain the stored speed on uphill gradients. The

stored speed is resumed when the gradient evens out. Cruise control maintains the stored speed on downhill gradients by automatically applying the brakes.

Storing the current speed or calling up the last stored speed

⚠ WARNING

If you call up the stored speed and it differs from the current speed, the vehicle accelerates or decelerates. If you do not know the stored speed, the vehicle could accelerate or brake unexpectedly. There is a risk of an accident.

Pay attention to the road and traffic conditions before calling up the stored speed. If you do not know the stored speed, store the desired speed again.

- ▶ Briefly pull the cruise control lever towards you ④.
- ▶ Remove your foot from the accelerator pedal.
The first time cruise control is activated, it stores the current speed or regulates the speed of the vehicle to the previously stored speed.

Setting a speed

Keep in mind that it may take a brief moment until the vehicle has accelerated or braked to the speed set.

- ▶ Press the cruise control lever to the pressure point, up ① for a higher speed or down ② for a lower speed.
- ▶ Keep the cruise control lever pressed until the desired speed is reached.
- ▶ Release the cruise control lever.
The new speed is stored.

i Cruise control is not deactivated if you depress the accelerator pedal. For example, if you accelerate briefly to overtake, cruise control adjusts the

vehicle's speed to the last speed stored after you have finished overtaking.

Making adjustments in 1 mph increments

- ▶ Briefly press the cruise control lever to the pressure point, up ① for a higher speed or down ② for a lower speed. The last speed stored is increased or reduced.

Making adjustments in 10 mph increments

- ▶ Briefly press the cruise control lever beyond the pressure point, up ① for a higher speed or down ② for a lower speed. The last speed stored is increased or reduced.

Deactivating cruise control

There are several ways to deactivate cruise control:

- ▶ Briefly press the cruise control lever forwards ③.

or

- ▶ Brake.

Cruise control is automatically deactivated if:

- you press the electric parking brake handle.
- you are driving below 20 mph (30 km/h).
- ESP® intervenes or you deactivate ESP®.
- you shift the transmission to **N** while the vehicle is in motion.

If cruise control is deactivated, you will hear a warning tone. The "Cruise control off" message is displayed in the multifunction display for approximately five seconds.

- ❗ The last speed stored is cleared when you switch off the engine.

AMG adaptive sport suspension system

General notes

The electronically controlled damping system works continuously. This improves driving safety and ride comfort.

The damping is tuned individually to each wheel and depends on:

- your driving style, e.g. sporty
- the road surface condition, e.g. bumps
- your individual selection of Sport, Sport + or Comfort

If you select Comfort or Sport + mode and restart the engine, the mode reverts to Sport.

- ❗ **GT model:** you can only choose between Sport and Sport + modes. If you select Sport + mode and restart the engine, the mode reverts to Sport.

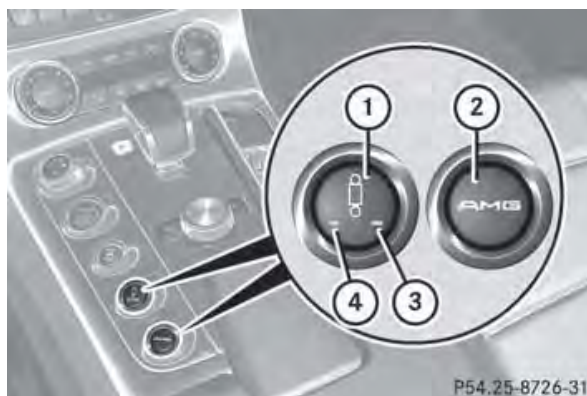

Sport mode

The firmer suspension tuning in Sport mode ensures even better contact with the road. Select this mode when employing a sporty driving style, e.g. on winding country roads.

- ▶ Press button ① once. Indicator lamp ④ lights up. You have selected Sport mode.

The **AMG Ride Control SPORT** message appears in the multifunction display.

- ❗ **GT model:** Sport mode is the standard setting. Indicator lamp ④ cannot be switched off.

Sport + mode

The very firm setting of the suspension tuning in Sport + mode ensures the best possible contact with the road. Select this mode only when driving on race circuits.

If indicator lamps ③ and ④ are off:

- ▶ Press button ① twice.
Indicator lamps ③ and ④ light up. You have selected Sport + mode.
The **AMG Ride Control SPORT +** message appears in the multifunction display.

If indicator lamp ④ lights up:

- ▶ Press button ① once.
Second indicator lamp ③ lights up. You have selected Sport + mode.
The **AMG Ride Control SPORT +** message appears in the multifunction display.

Comfort mode

i GT model: Comfort mode is unavailable.

In comfort mode, the driving characteristics of your vehicle are more comfortable. Select this mode if you favor a more comfortable driving style, but also when driving fast on straight roads, e.g. freeways.

- ▶ Press button ① repeatedly until indicator lamps ③ and ④ go out.
You have selected Comfort mode.
The **AMG Ride Control COMFORT** message appears in the multifunction display.

Storing and calling up settings

Once the suspension tuning and drive program have been selected, you can store and call up your settings using AMG button ②.

- ▶ **To store:** press AMG button ② until you hear a tone.

- ▶ **To call up:** press AMG button ②.

The stored suspension tuning and drive program are selected.

- ▶ **To display:** briefly press AMG button ②.
Your selection appears in the multifunction display.

PARKTRONIC

Important safety notes

PARKTRONIC is an electronic parking aid with ultrasonic sensors. It indicates visually and audibly the distance between your vehicle and an object.

PARKTRONIC is only an aid. It is not a replacement for your attention to your immediate surroundings. You are always responsible for safe maneuvering, parking and exiting a parking space. When maneuvering, parking or pulling out of a parking space, make sure that there are no persons, animals or objects in the area in which you are maneuvering.

- !** When parking, pay particular attention to objects above or below the sensors, such as flower pots or trailer drawbars.
PARKTRONIC does not detect such objects when they are in the immediate vicinity of the vehicle. You could damage the vehicle or the objects.

The sensors may not detect snow and other objects that absorb ultrasonic waves.

Ultrasonic sources such as an automatic car wash, the compressed-air brakes on a truck or a pneumatic drill could cause PARKTRONIC to malfunction.

PARKTRONIC may not function correctly on uneven terrain.

PARKTRONIC is activated automatically when you:

- switch on the ignition
- release the electric parking brake

PARKTRONIC is deactivated at speeds above 11 mph (18 km/h). It is reactivated at lower speeds.

PARKTRONIC monitors the area around your vehicle using four sensors in the front bumper and four sensors in the rear bumper.

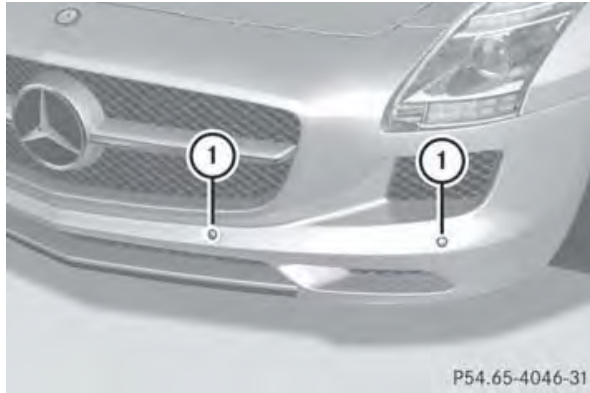

- ① Sensors in the front bumper, left-hand side (example)

Range of the sensors

General notes

PARKTRONIC does not take objects into consideration that are:

- below the detection range, e.g. people, animals or objects
- above the detection range, e.g. overhanging loads, truck overhangs or loading ramps.

The sensors must be free from dirt, ice or slush. They can otherwise not function correctly. Clean the sensors regularly, taking care not to scratch or damage them (▷ page 224).

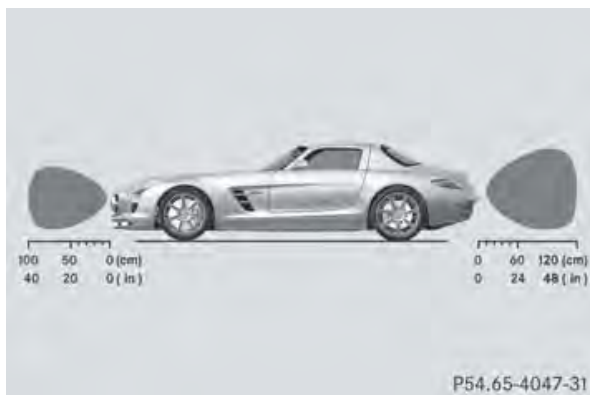

Example: side view (Coupe)

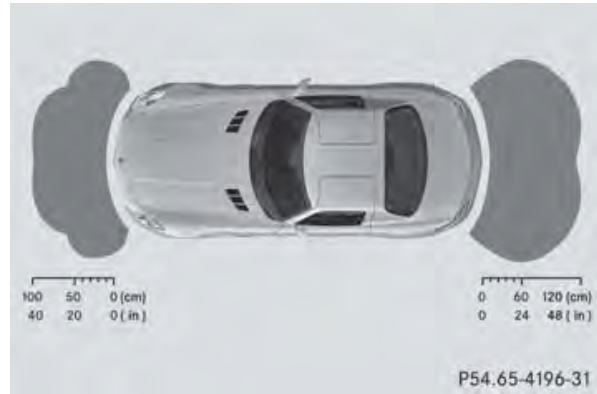

Example: top view (Coupe)

Front sensors

Center	approx. 40in (approx. 100cm)
Corners	approx. 24in (approx. 60cm)

Rear sensors

Center	approx. 48in (approx. 120cm)
Corners	approx. 32in (approx. 80cm)

Minimum distance

Center	approx. 12in (approx. 30cm)
Corners	approx. 12in (approx. 30cm)

If there is an obstacle within this range, the relevant warning displays light up and a warning tone sounds. If the distance falls below the minimum, the distance may no longer be shown.

Warning displays

The warning displays show the distance between the sensors and the obstacle. The warning display for the front area is located on the dashboard above the center air vents. The warning display for the rear area is in the rear compartment on the parcel shelf.

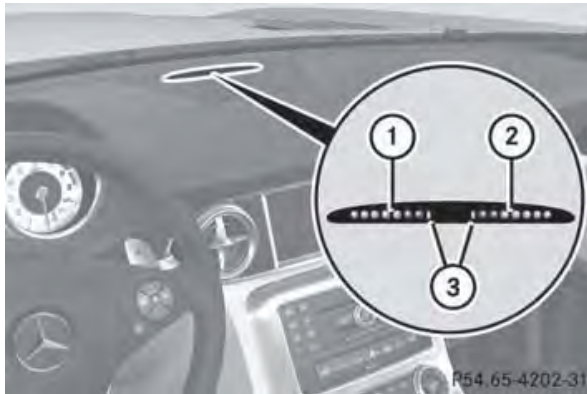

Warning display for the front area

- ① Left-hand side of the vehicle
- ② Right-hand side of the vehicle
- ③ Segments showing operational readiness

The warning display for each side of the vehicle is divided into five yellow and two red segments. PARKTRONIC is operational if yellow segments showing operational readiness ③ light up.

The selector lever position determines which warning display is active while the engine is running:

Transmission position	Warning display
D	Front area activated
R or N	Rear and front areas activated
P	No areas activated

One or more segments light up as the vehicle approaches an obstacle, depending on the vehicle's distance from the obstacle.

From the:

- sixth segment onwards, you will hear an intermittent warning tone for approximately two seconds.
- seventh segment onwards, you will hear a warning tone for approximately two seconds. This indicates that you have now reached the minimum distance.

Deactivating/activating PARKTRONIC

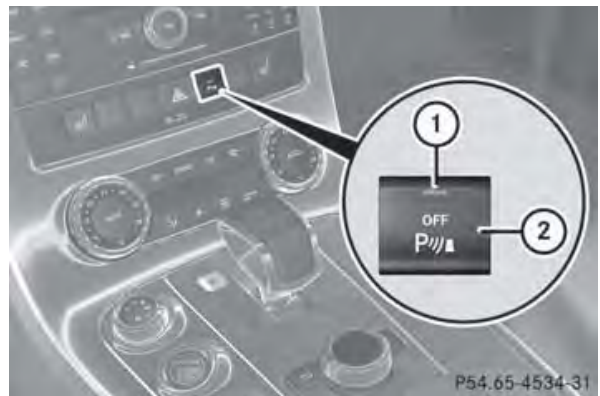

- ① Indicator lamp
- ② To deactivate/activate PARKTRONIC

If indicator lamp ① lights up, PARKTRONIC is deactivated.

- i** PARKTRONIC is automatically activated when you switch on the ignition and release the parking brake.

Problems with PARKTRONIC

Problem	Possible causes/consequences and ► Solutions
Only the red segments in the PARKTRONIC warning displays are lit. You also hear a warning tone for approximately two seconds. PARKTRONIC is deactivated after approximately 20 seconds, and the indicator lamp in the PARKTRONIC button lights up.	<p>PARKTRONIC has malfunctioned and has switched off.</p> <p>► If problems persist, have PARKTRONIC checked at a qualified specialist workshop.</p>
Only the red segments in the PARKTRONIC warning displays are lit. PARKTRONIC is deactivated after approximately 20 seconds.	<p>The PARKTRONIC sensors are dirty or there is interference.</p> <p>► Clean the PARKTRONIC sensors (▷ page 224).</p> <p>► Switch the ignition back on.</p> <p>The problem may be caused by an external source of radio or ultrasound waves.</p> <p>► See if PARKTRONIC functions in a different location.</p>

Rear view camera

Important safety notes

The rear view camera is only an aid. It is not a replacement for your attention to your immediate surroundings. You are always responsible for safe maneuvering and parking. When maneuvering or parking, make sure that there are no persons, animals or objects in the area in which you are maneuvering.

Under the following circumstances, the rear view camera will not function, or will function in a limited manner:

- if the trunk lid is open
- in heavy rain, snow or fog
- at night or in very dark places
- if the camera is exposed to very bright light

- if the area is lit by fluorescent light or LED lighting (the display may flicker)
- if there is a sudden change in temperature, e.g. when driving into a heated garage in winter
- if the camera lens is dirty or obstructed
- if the rear of your vehicle is damaged. In this event, have the camera position and setting checked at a qualified specialist workshop.

General notes

Rear view camera ① is an optical parking aid. It shows the area behind your vehicle in the COMAND display.



View through the camera

The area behind the vehicle is displayed as a mirror image, as in the rear view mirror.

! Objects not at ground level may appear to be further away than they actually are, e.g.:

- the bumper of a parked vehicle
- the drawbar of a trailer
- the ball coupling of a trailer tow hitch
- the rear section of an HGV
- a slanted post

Use the guidelines only for orientation. Approach objects no further than the bottom-most guideline.

The rear view camera may show a distorted view of obstacles, show them incorrectly or not at all. The rear view camera does not show objects in the following positions:

- very close to the rear bumper
- under the rear bumper
- in the area immediately above the tailgate handle

Activating the rear view camera

- ▶ Make sure that key position **2** has been selected with the Start/Stop button.
- ▶ Make sure that the "rear view camera" function is selected in COMAND (see the

separate operating instructions for COMAND).

- ▶ Engage reverse gear. The COMAND display shows the area behind the vehicle.

You can also switch off the display of the area behind the vehicle in the COMAND display.

Blind Spot Assist

Important safety notes

Blind Spot Assist uses a radar sensor system to monitor the areas on both sides of your vehicle. It supports you from speeds of approximately 20 mph (30 km/h). A warning display in the exterior mirrors draws your attention to vehicles detected in the monitored area. If you then switch on the corresponding turn signal to change lanes, you will also receive a visual and audible collision warning. For this purpose, Blind Spot Assist uses sensors in the rear bumper.

Blind Spot Assist is only an aid. It may fail to detect some vehicles and is no substitute for attentive driving.

⚠ WARNING

Blind Spot Assist does not react to:

- vehicles overtaken too closely on the side, placing them in the blind spot area
- vehicles approaching and driving by with a speed difference of more than 6.8 mph (11 km/h)

As a result, Blind Spot Assist may not give warnings in such situations. There is a risk of an accident.

Always observe the traffic conditions carefully, and maintain a safe lateral distance.

i USA only:

This device has been approved by the FCC as a "Vehicular Radar System". The radar sensor is intended for use in an automotive radar system only. Removing, tampering with, or altering the device will void any

warranties, and is not permitted by the FCC. Do not tamper with, alter, or use in any non-approved way.

Any unauthorized modification to this device could void the user's authority to operate the equipment.

Monitoring range of the sensors

In particular, the detection of obstacles can be impaired if:

- there is dirt on the sensors or anything else covering the sensors.
- there is poor visibility, e.g. due to fog, heavy rain or snow.
- a narrow vehicle, e.g. a motorbike or bicycle, is traveling in front.
- the road has very wide lanes.
- the road has narrow lanes.
- you are not driving in the middle of the lane.
- there are barriers or similar lane borders.

Vehicles in the monitoring range are then not indicated.

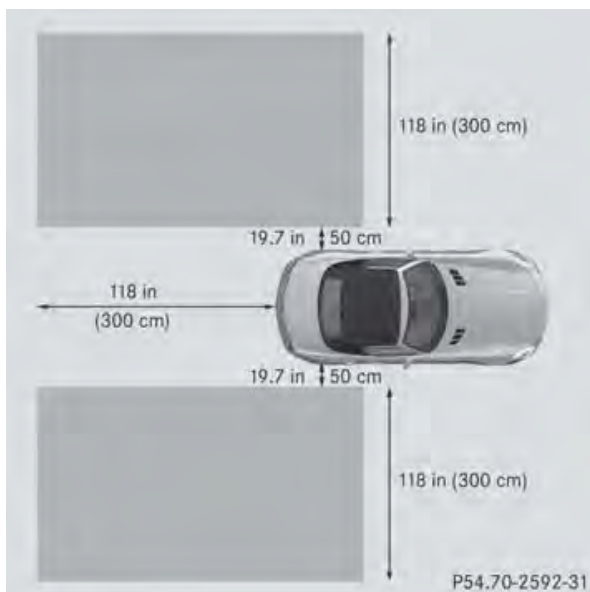

Example (Roadster)

Blind Spot Assist monitors the area up to 10 ft (3m) behind your vehicle and directly next to your vehicle, as shown in the diagram. If the lanes are narrow, vehicles driving in the lane beyond the lane next to your vehicle may be indicated, especially if the vehicles are not

driving in the middle of their lane. This may be the case if the vehicles are driving on the inner side of their lane.

Due to the nature of the system:

- warnings may be issued in error when driving close to crash barriers or similar solid lane borders.
- warnings may be interrupted when driving alongside particularly long vehicles, e.g. trucks, for a prolonged time.

The two sensors for Blind Spot Assist are integrated into the sides of the rear bumper. Make sure that the bumper is free of dirt, ice or slush in the vicinity of the sensors. The radar sensors must not be covered, e.g. by overhanging loads. Following a severe impact or in the event of damage to the bumpers, have the function of the radar sensors checked at a qualified specialist workshop. Blind Spot Assist may otherwise not work properly.

Indicator and warning display

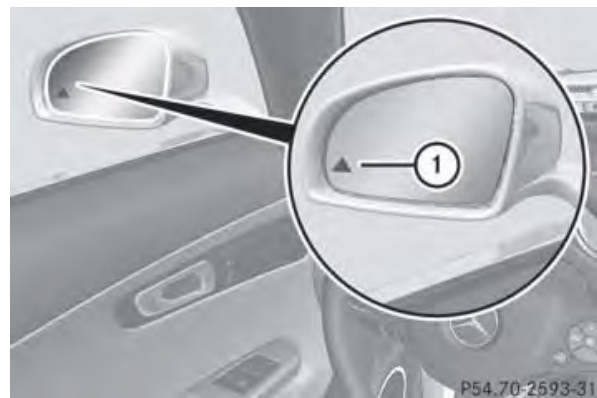

① Yellow indicator lamp/red warning lamp

When Blind Spot Assist is activated, indicator lamp ① in the exterior mirrors lights up yellow up to a speed of 20 mph (30 km/h). At speeds above 20 mph (30 km/h) the indicator lamp goes out and Blind Spot Assist is operational.

If a vehicle is detected within the monitoring range of Blind Spot Assist at speeds above approximately 20 mph (30 km/h), warning lamp ① on the corresponding side lights up red. This warning is always given when a

vehicle enters the blind spot monitoring range from behind or from the side. When you overtake a vehicle, the warning only occurs if the difference in speed is less than 7 mph (12 km/h).

The yellow indicator lamp goes out if reverse gear is engaged. In this event, Blind Spot Assist is no longer active.

The brightness of the indicator/warning lamps is adjusted automatically according to the ambient light.

Collision warning

If a vehicle is detected in the monitoring range of Blind Spot Assist and you switch on the corresponding turn signal, a double warning tone sounds. Red warning lamp ① flashes. If the turn signal remains on, vehicles detected are indicated by the flashing of red warning lamp ①. There are no further warning tones.

Switching on Blind Spot Assist

- ▶ Make sure that Blind Spot Assist (▷ page 153) is activated in the on-board computer.
- ▶ Ensure that key position **2** has been selected with the Start/Stop button. Warning lamps ① in the exterior mirrors light up red for approximately 1.5 seconds and then turn yellow.

Useful information	146
Important safety notes	146
Displays and operation	146

Useful information

- i** This Operator's Manual describes all models and all standard and optional equipment of your vehicle available at the time of publication of the Operator's Manual. Country-specific differences are possible. Please note that your vehicle may not be equipped with all features described. This also applies to safety-related systems and functions.
- i** Please read the information on qualified specialist workshops (▷ page 22).

Important safety notes

You will find an illustration of the instrument cluster in the "At a glance" section (▷ page 27).

WARNING

A driver's attention to the road and traffic conditions must always be his/her primary focus when driving.

For your safety and the safety of others, selecting features through the multifunction steering wheel should only be done by the driver when traffic and road conditions permit it to be done safely.

Bear in mind that at a speed of just 30 mph (approximately 50 km/h), your vehicle is covering a distance of 44 feet (approximately 14 m) every second.

WARNING

No messages will be displayed if either the instrument cluster or the multifunction display is inoperative.

As a result, you will not be able to see information about your driving conditions, such as

- speed
- outside temperature
- warning/indicator lamps

- malfunction/warning messages
- failure of any systems

Driving characteristics may be impaired.

If you must continue to drive, do so with added caution. Contact an authorized Mercedes-Benz Center as soon as possible.

WARNING

Malfunction and warning messages are only indicated for certain systems and are intentionally not very detailed. The malfunction and warning messages are simply a reminder with respect to the operation of certain systems. They do not replace the owner's and/or driver's responsibility to maintain the vehicle's operating safety. Have all required maintenance and safety checks performed on the vehicle. Bring the vehicle to an authorized Mercedes-Benz Center to address the malfunction and warning messages.

Displays and operation

Engine oil temperature display

The engine oil temperature gauge is in the instrument cluster on the right-hand side. Under normal operating conditions, the temperature may rise to 140 °C.

The transmission fluid temperature and the coolant temperature are displayed in the AMG menu (▷ page 157).

Tachometer

The red band in the tachometer indicates the engine's overrevving range.

! Do not drive in the overrevving range, as this could damage the engine.

The fuel supply is interrupted to protect the engine when the red band is reached.

Outside temperature display

⚠ WARNING

The outside temperature indicator is not designed to serve as an ice-warning device and is therefore unsuitable for that purpose. Indicated temperatures just above the freezing point do not guarantee that the road surface is free of ice. The road may still be icy, especially in wooded areas or on bridges.

The outside temperature display is in the multifunction display (▷ page 147). Changes in the outside temperature are displayed after a short delay.

Operating the on-board computer

The on-board computer is activated as soon as you turn the SmartKey to position **1** in the ignition lock.

You can control the multifunction display and the settings in the on-board computer using the buttons on the multifunction steering wheel.

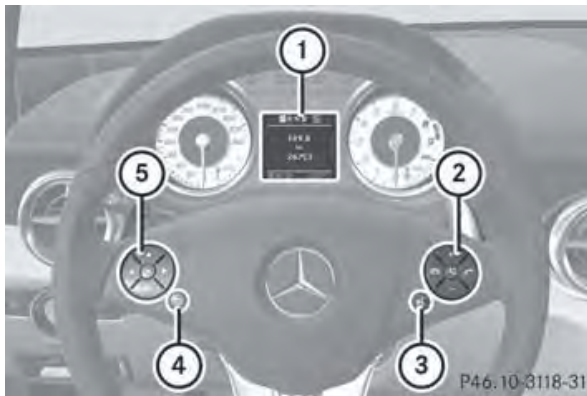

- ① Multifunction display
- ② Makes/accepts or rejects/ends a call
 Increases/reduces volume
- ③ Switches on the Voice Control System; see the separate operating instructions

- ④ **Press briefly:** back, deactivates the Voice Control System and fades out display messages
 Press and hold: selects the standard display
- ⑤ Selects the menu bar and selects menus
 Press briefly: selects a submenu or scrolls through lists
In the **Audio** menu, selects a stored station, an audio track or a video scene
In the **Te1** menu (telephone), switches to the telephone book and selects a name or a telephone number
 Press and hold: In the **Audio** menu, selects the previous/next station, selects an audio track or a video scene using rapid scroll
In the **Te1** menu (telephone), starts telephone book rapid scroll
 Confirms selection and hides display messages
In the **Te1** menu (telephone), switches to the phone book and starts dialing

Multifunction display

Values and settings as well as display messages are shown in the multifunction display.



- ① Selector lever position/shift range and drive program
 - ② Description field
 - ③ Menu bar
 - ④ Status line with time and outside temperature
- ▶ **To display menu bar ③:** press the ◀ or ▶ button on the steering wheel.

Menus and submenus

Menu overview

Press the ◀ or ▶ button on the steering wheel to call up the menu bar and select a menu.

Operating the on-board computer (▷ page 147).

Depending on the equipment installed in the vehicle, you can call up the following menus:

- **Trip** menu (▷ page 148)
- **Navi** menu (navigation instructions) (▷ page 149)
- **Audio** menu (▷ page 151)
- **Tel** menu (telephone) (▷ page 152)
- **DriveAssist** menu (assistance) (▷ page 141)
- **Service** menu (▷ page 153)
- **Settings** menu (▷ page 153)
- **AMG** menu (▷ page 157)

Trip menu

Standard display



- ▶ Press and hold the ◀ button on the steering wheel until the **Trip** menu with trip odometer ① and odometer ② is shown.

Trip computer "From Start" or "From Reset"

The values in the **From Start** submenu are calculated from the start of a journey whilst the values in the **From Reset** submenu are calculated from the last time the submenu was reset.

- ▶ Press the ◀ or ▶ button on the steering wheel to select the **Trip** menu.
- ▶ Press the ▲ or ▼ button to select **From Start** or **From Reset**.

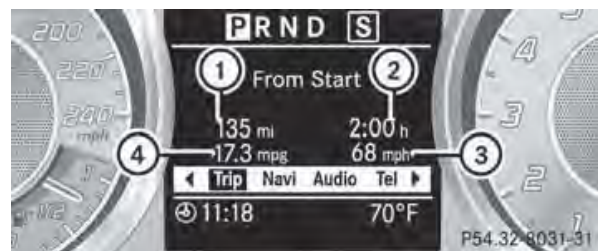

Example: trip computer "From Start"

- ① Distance
- ② Time
- ③ Average speed
- ④ Average fuel consumption

The **From Start** trip computer is automatically reset if:

- the ignition has been switched off for more than four hours.
- 999 hours have been exceeded.
- 9,999 miles have been exceeded.

The **From Reset** trip computer is automatically reset if the value exceeds 9,999 hours or 99,999 miles.

Calling up the range

- ▶ Press the or button on the steering wheel to select the **Trip** menu.



- ▶ Press or to select approximate range ①.

Approximate range ① is calculated according to current driving style and the amount of fuel in the tank. If there is only a small amount of fuel left in the fuel tank, the display shows a vehicle being refueled instead of range ①.

Digital speedometer

- ▶ Press the or button on the steering wheel to select the **Trip** menu.
- ▶ Press the or button to select the digital speedometer.



① Digital speedometer

Resetting values

You can reset the values of the following functions:

- trip odometer
- trip computer "From start"
- trip computer "From reset"

- ▶ Press the or button to select the **Trip** menu.
- ▶ Press the or button to select the function that you wish to reset.
- ▶ Press .

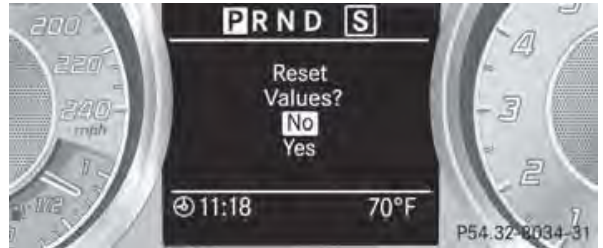

Resetting the trip computer "From start" (example)

- ▶ Press the button to select **Yes** and press the button to confirm.

Navigation system menu

Displaying navigation instructions

In the **Navi** menu, the multifunction display shows navigation instructions. You can find further information in the separate COMAND operating instructions.

- ▶ Press the or button on the steering wheel to select the **Navi** menu.

Route guidance inactive

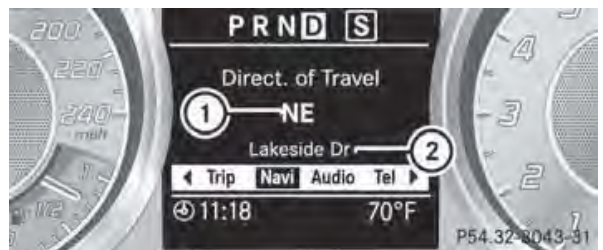

Example: direction of travel display

- ① Direction of travel
- ② Current road

Route guidance active**No change of direction announced**

- ① Distance to the destination
- ② Distance to the next change of direction
- ③ Current road
- ④ Symbol for "follow the road's course"

Change of direction announced without a lane recommendation

- ① Road into which the change of direction leads
- ② Distance to change of direction and visual distance display
- ③ Symbol for change of direction

When a change of direction has been announced, you will see visual distance display ② next to the symbol for change of direction ③. This decreases in size as you approach the announced change of direction.

Change of direction announced with a lane recommendation

Lane recommendations are only displayed if the relevant data is available on the digital map.



- ① Road into which the change of direction leads
- ② Distance to change of direction and visual distance display
- ③ Lane recommendation
- ④ Symbol for change of direction

On multi-lane roads, lane recommendation

③ may be shown for the next change of direction. Lanes may be added during a change of direction.



Lane recommendation display (example)

- ① Uninterrupted lane
- ② New lane during a change of direction
- ③ Lane recommended for the change of direction

You can find further information on lane recommendation in the separate COMAND operating instructions.

Other status indicators of the navigation system

-  : you have reached the destination.
- **New Route...** or **Calculating Route**: a new route is being calculated.
- **Off Map** or **Off Mapped Road**: the vehicle position is outside the area of the digital map (off-map position).
- **No Route**: no route could be calculated to the selected destination.

You can find further information on status indicators in the separate COMAND operating instructions.

Audio menu

Selecting a radio station

You can only change the waveband and store new stations using COMAND.

- ▶ Press the or button on the steering wheel to select the **Audio** menu.



- ① Waveband
- ② Station⁶

- ▶ **To select a stored station:** briefly press the or button.
- ▶ **To select a station from the station list:** press and hold the or button.
- ▶ **To select a station using manual tuning** (only when a station list is not received): press and hold or .

- ❗ SIRIUS XM satellite radio functions like a normal radio.

You can find further information on operating the satellite radio in the separate operating instructions.

Operating an audio player or audio media

Audio data from various audio devices or media can be played, depending on the equipment installed in the vehicle.

- ▶ Press the or button on the steering wheel to select the **Audio** menu.



CD player display (example)

- ① Current track

- ▶ **To select the next/previous track:** briefly press the or button.
- ▶ **To select a track from the track list (rapid scrolling):** press and hold the or button until the desired track has been reached.

If track information is stored on the audio device or medium, the multifunction display will show the number and name of the track. The current track does not appear in audio AUX mode (**Auxiliary** audio mode: external audio source connected).

Video DVD operation

- ▶ Press the or button on the steering wheel to select the **Audio** menu.

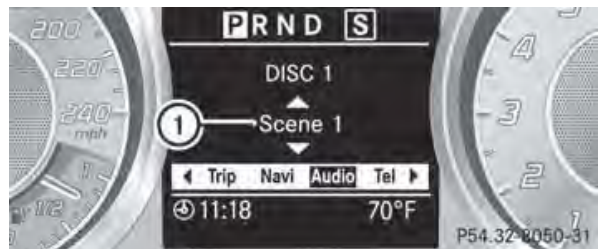

- ▶ **To select the next or previous scene:** briefly press the or button.
- ▶ **To select a scene from the scene list (rapid scrolling):** press and hold the or button until the desired scene has been reached.

⁶ If the station has been stored, the memory position will also be displayed.

Telephone menu



Introduction

WARNING

A driver's attention to the road must always be his/her primary focus when driving. For your safety and the safety of others, we recommend that you pull over to a safe location and stop before placing or taking a telephone call. If you choose to use the telephone while driving, please use the hands-free device and only use the telephone when weather, road and traffic conditions permit. Some jurisdictions prohibit the driver from using a mobile phone while driving a vehicle. Bear in mind that at a speed of just 30 mph (approximately 50 km/h), your vehicle is covering a distance of 44 feet (approximately 14 m) every second.

Functions and displays are dependent on the optional equipment installed in your vehicle.

You can establish a Bluetooth® connection to COMAND (see the separate operating instructions).

- ▶ Switch on the mobile phone and COMAND.
- ▶ Press the  or  button on the steering wheel to select the **Te1** menu.

You will see one of the following display messages in the multifunction display:

- **Enter PIN:** the mobile phone has been placed in the mobile phone bracket and the PIN has not been entered.
- ▶ Enter the PIN using the mobile phone, Voice Control System or COMAND. The mobile phone will search for a network. In the meantime, the **Phone No Service** display message appears in the multifunction display.
- **Phone Ready** or the name of the network provider: the mobile phone has found a network and is ready to receive.
- **Phone No Service:** there is no network available or the mobile phone is searching for a network.

Accepting a call

If someone calls you when you are in the **Te1** menu, a display message appears in the multifunction display, for example:

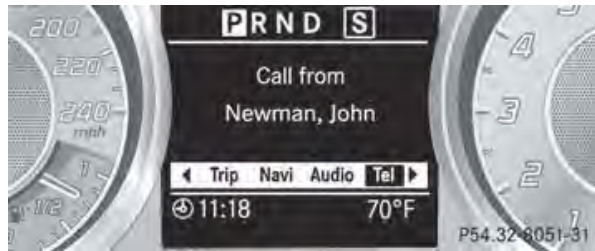

- ▶ Press the  button on the steering wheel to accept an incoming call.

You can accept a call even if you are not in the **Te1** menu.









Rejecting or ending a call

- ▶ Press the  button on the steering wheel.



You can end or reject a call even if you are not in the **Te1** menu.

Dialing a number from the phone book



If your mobile phone is able to receive calls, you can search for and dial a number from the phone book in COMAND at any time.

- ▶ Copy the phone book from the mobile phone to COMAND.
- ▶ Press the  or  button on the steering wheel to select the **Te1** menu.
- ▶ Press the ,  or  button to call up the phone book.
- ▶ Press the  or  button to select the desired name. To scroll rapidly, press and hold the  or the  button for longer than one second. After a short time, the rapid scroll speeds up.



Rapid scrolling stops when you release the button or reach the end of the list.

- ▶ **If only one telephone number is stored for a name:** press the  or  button to start dialing.

or

- ▶ **If there is more than one number for a particular name:** press the  or  button to display the numbers.

- ▶ Press the  or  button to select the number you want to dial.







- ▶ Press the  or  button to start dialing.

or

- ▶ **If you do not want to make a call:** press the  button.

Redialing





The on-board computer saves the last names or numbers dialed in the redial memory.

- ▶ Press the  or  button on the steering wheel to select the **Te1** menu.
- ▶ Press the  button to switch to the redial memory.
- ▶ Press the  or  button to select the desired name or number.
- ▶ Press the  or  button to start dialing.

Assistance menu

Activating/deactivating Blind Spot Assist

You can use the **Blind Spot Asst.** function to activate or deactivate Blind Spot Assist (▷ page 141).

- ▶ Press the  or  button on the steering wheel to select the **DriveAssist** menu.
- ▶ Press .
- ▶ The current selection is displayed.
- ▶ **To activate/deactivate:** press  again.

Maintenance menu

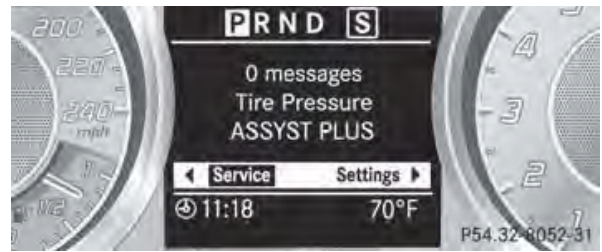

In the **Serv.** menu, you can:

- call up display messages (▷ page 160)
- check the tire pressure electronically (▷ page 255)
- call up the service due date (▷ page 218)

Settings menu

Introduction



In the **Settings** menu you can:

- change the instrument cluster settings (▷ page 153)
- change the light settings (▷ page 154)
- change the vehicle settings (▷ page 156)
- change the convenience settings (▷ page 156)
- restore the factory settings (▷ page 156)









Instrument cluster

Selecting the unit of measurement for distance

The **Display Unit Speed-/Odometer:** function allows you to choose whether certain displays appear in km/h or mph in the multifunction display.









The selected units apply to:

- the odometer and the trip odometer
- the trip computer
- the digital speedometer in the **Trip** menu

- the digital speedometer in the [AMG](#) menu
- the navigation instructions in the [Navi](#) menu
- cruise control
- ▶ Press the  or  button on the steering wheel to select the [Settings](#) menu.
- ▶ Press the  or  button to select the [INST. CLUSTER](#) submenu.
- ▶ Press  to confirm.
- ▶ Press the  or  button to select the [Display Unit Speed-/Odometer:](#) function.
You will see the selected setting: [km](#) or [miles](#).
- ▶ Press the  button to save the setting.

Permanent display for outside temperature or additional speedometer



The [Permanent display: Outside Temperature/Speedometer](#) allows you to choose whether the multifunction display shows the outside temperature or the speed at the bottom right. The unit used in the additional speedometer depends on the display unit set (▷ page 153).

- ▶ Press the  or  button on the steering wheel to select the [Settings](#) menu.
- ▶ Press the  or  button to select the [INST. CLUSTER](#) submenu.
- ▶ Press the  button to confirm.
- ▶ Press the  or  button to select the [Permanent display](#) function.
You will see the selected setting [\[km/h\]](#) or [Dig. speedom \[mph\]](#) or [outside temperature](#).
- ▶ Press the  button to save the setting.









Lights

Switching the daytime running lamps on/off

This function is not available in Canada.







If you have activated the [Daytime Running Lights](#) function and the light switch is in the  or  position, the daytime running lamps are switched on automatically when the engine is running. If it is dark, the low-beam headlamps switch on automatically.

In the dark, the following also light up:



- the low-beam headlamps
- the standing lamps
- the tail lamps
- the license plate lamp
- the side marker lamps
- ▶ Press the  or  button on the steering wheel to select the [Settings](#) menu.
- ▶ Press the  or  button to select the [LIGHTS](#) submenu.
- ▶ Press the  button to confirm.
- ▶ Press the  or  button to select the [Daytime Running Lights](#) function.
You will see the selected setting: [Enabled](#) or [Disabled](#).
- ▶ Press the  button to save the setting.

Setting the brightness for the display and switches

You can use the [Brightness display/switches](#) function to set the brightness of the multifunction display and the switches in the vehicle.

- ▶ Press the  or  button on the steering wheel to select the [Settings](#) menu.
- ▶ Press the  or  button to select the [Light](#) submenu.
- ▶ Press the  button to confirm.
- ▶ Press the  or  button to select the [Brightness Display/Switches:](#) function.

You see the selected setting [Level](#) with a value of between 0 and 100.









- ▶ Press the  button to save the setting.
- ▶ Press the  or  button to increase or decrease the brightness.

Activating/deactivating surround lighting and exterior lighting delayed switch-off

The **Locator lighting** function allows you to set whether the exterior lighting should come on when it is dark:

- for 40 seconds after unlocking the vehicle with the SmartKey
The exterior lighting switches off if you open the driver's door.
- for 15 seconds after switching off the engine and closing the doors
If the engine is switched off and then none of the doors are opened, or if an open door is not closed, the exterior lighting goes out after 60 seconds.

If you activate the **Locator Lighting** function, the following light up:

- the parking lamps
- the low-beam headlamps
- the license plate lamp
- the surround lighting in the exterior mirrors
- ▶ Press the  or  button on the steering wheel to select the **Settings** menu.
- ▶ Press the  or  button to select the **Light** submenu.
- ▶ Press the  button to confirm.
- ▶ Press the  or  button to select the **Locator Lighting** function.
You will see the selected setting: **on** or **off**.
- ▶ Press the  button to save the setting.









Deactivating the delayed switch-off temporarily:

- ▶ Select key position **0** with the Start/Stop button before leaving the vehicle.
- ▶ Select key position **2** and then key position **0** again with the Start/Stop button
The delayed switch-off is deactivated.

Delayed switch-off is reactivated the next time you start the engine.

Activating/deactivating the interior lighting delayed switch-off





If you select key position **0** with the Start/Stop button when the **Light. Delay** function is activated, the interior lighting lights up for approximately 20 seconds if it is dark.



- ▶ Press the  or  button on the steering wheel to select the **Settings** menu.
- ▶ Press the  or  button to select the **Light** submenu.
- ▶ Press the  button to confirm.
- ▶ Press the  or  button to select the **Interior lighting delay sw. off** function.
You will see the selected setting: **Enabled** or **Disabled**.
- ▶ Press the  button to save the setting.

Vehicle

Activating/deactivating the automatic door locking mechanism









If you select the **Automatic Door Lock:** function, the vehicle is centrally locked above a speed of around 9 mph (15 km/h).

- i** For further information on the automatic locking feature, see (▷ page 69).
- ▶ Press the  or  button on the steering wheel to select the **Settings** menu.
- ▶ Press the  or  button to select the **Vehicle** submenu.
- ▶ Press the  button to confirm.

- ▶ Press the  or  button to select the **Automatic door locks** function. You will see the selected setting: **Enabled** or **Disabled**.
- ▶ Press the  button to save the setting.

Activating/deactivating the acoustic locking verification signal

You can use the **Acoustic Lock** function to determine whether there is an acoustic confirmation when locking and unlocking the vehicle.

- ▶ Press the  or  button on the steering wheel to select the **Settings** menu.
- ▶ Press the  or  button to select the **VEHICLE** submenu.
- ▶ Press the  button to confirm.
- ▶ Press the  or  button to select the **Acoustic Lock** function. You will see the selected setting: **Activated** or **Deactivated**.
- ▶ Press the  button to save the setting.

Convenience

Activating/deactivating the EASY-ENTRY/EXIT feature









WARNING

You must make sure no one can become trapped or injured by the moving steering wheel when the easy-entry/exit feature is activated.

To stop steering wheel movement, move steering wheel adjustment lever or press one of the memory position buttons.

Do not leave children unattended in the vehicle, or with access to an unlocked vehicle. Children could open the driver's door and unintentionally activate the easy-entry/exit feature, which could result in an accident and/or serious personal injury.









You can use the **Easy Entry/Exit:** function to activate or deactivate the EASY-ENTRY/EXIT feature (▷ page 86).

- ▶ Press the  or  button on the steering wheel to select the **Settings** menu.
- ▶ Press the  or  button to select the **Convenience** submenu.
- ▶ Press  to confirm.
- ▶ Press the  or  button to select the **Easy Entry/Exit** function. You will see the selected setting: **Activated** or **Deactivated**.
- ▶ Press the  button to save the setting.

Switching the fold-in mirrors when locking feature on/off

If you switch on the **Fold Mirrors in when Locking:** function, the exterior mirrors fold in when you lock the vehicle. If you unlock the vehicle and then open the driver's or front-passenger door, the exterior mirrors fold out again.

If you have switched the function on and you fold the exterior mirrors in using the button on the door (▷ page 88), they will not fold out automatically. The exterior mirrors can then only be folded out using the button on the door.

- ▶ Press the  or  button on the steering wheel to select the **Settings** menu.
- ▶ Press the  or  button to select the **CONVENIENCE** submenu.
- ▶ Press the  button to confirm.
- ▶ Press the  or  button to select the **Fold mirrors in when locking:** function. You will see the selected setting: **on** or **off**.
- ▶ Press the  button to save the setting.

Restoring the factory settings

For safety reasons, the **Day Lights** function in the **Lights** submenu is only reset if the vehicle is stationary.

- ▶ Press the or button on the steering wheel to select the **Settings** menu.
- ▶ Press the or button to select the **Factory Settings** submenu.
- ▶ Press to confirm. The **Reset All Settings?** message appears.
- ▶ Press the or button to select **Yes** or **No**.
- ▶ Press the button to confirm the selection. If you have selected **Yes**, the multifunction display shows a confirmation message.

AMG menu

AMG displays

- ▶ Press or on the steering wheel to select the **AMG** menu.

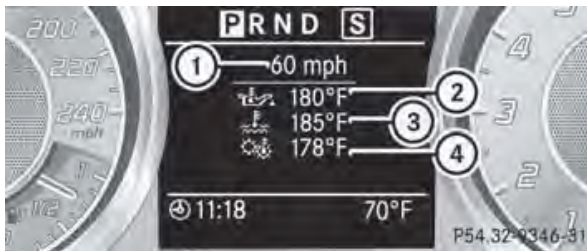

- ① Digital speedometer
- ② Engine oil temperature
- ③ Coolant temperature
- ④ Transmission fluid temperature

If the engine oil temperature is below 80 °C or if the transmission fluid temperature is below 60 °C, the corresponding temperature gauge flashes. Avoid driving at full engine output during this time.

SETUP

SETUP displays the drive program, the AMG adaptive sport suspension system setting and the selected traction assist.

- ▶ Press or on the steering wheel to select the **AMG** menu.
 - ▶ Press the button repeatedly until SETUP is displayed.
- or
- ▶ Press the AMG button on the center console.



- ① Drive program (**C/S/S+/M**)
- ② ESP® mode (**ON/Sport Handling Mode/OFF**)
- ③ AMG adaptive sport suspension system setting (**COMFORT/SPORT/SPORT +**)

RACETIMER

Displaying and starting RACETIMER

WARNING

The RACETIMER feature is only for use on roads and in conditions where high speed driving is permitted. Racing on public roads is prohibited under all circumstances. The driver is and must always remain responsible for following posted speed limits.

You can use the RACETIMER to store lap times.

- ▶ Press or on the steering wheel to select the **AMG** menu.
- ▶ Press the button repeatedly until the RACETIMER is shown.

- i** If the RACETIMER is selected, the and buttons are inoperative.



- ① Digital speedometer
- ② RACETIMER
- ③ Lap

You can start the RACETIMER when the engine is running or if key position **2** is selected with the Start/Stop button.

- ▶ **To start:** start the RACETIMER with .

Displaying the intermediate time



- ▶ Press the or button to select **Interm. Time**.
- ▶ Press to confirm.
The intermediate time is displayed for five seconds.

Starting a new lap

It is possible to store a maximum of sixteen laps.

- ▶ Press to confirm **New Lap**.



- ① RACETIMER
- ② Fastest lap time (best lap)
- ③ Lap

Stopping the RACETIMER

- ▶ Press the button on the steering wheel.



- ▶ Press to confirm **Yes**.

If you stop the vehicle and select key position **1** with the Start/Stop button, the RACETIMER interrupts timing. If you select key position **2** or **3** with the Start/Stop button and then press to select **START**, timing is continued.

Resetting the current lap

- ▶ Stop the RACETIMER.
- ▶ Press the or button to select **Reset Lap**.
- ▶ Press to reset the lap time to "0".

Deleting all laps



If you switch off the engine, the RACETIMER is reset to "0" after 30 seconds. All laps are deleted.

You cannot delete individual stored laps. If you have stopped 16 laps, the current lap does not have to be reset.

- ▶ Reset the current lap.
- ▶ Press to confirm **Reset**.

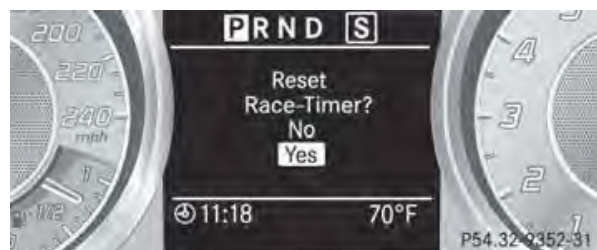

Reset Race Timer appears in the multifunction display.



- ▶ Press the  button to select **Yes** and press the  button to confirm. All laps are deleted.

Overall statistics

This function is shown if you have stored at least one lap and stopped the RACETIMER.

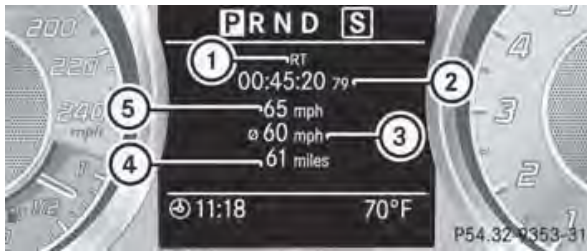

- ▶ Press  or  on the steering wheel to select the **AMG** menu.
- ▶ Press the  button repeatedly until the overall evaluation is shown.



- ① RACETIMER overall evaluation
- ② Total time driven
- ③ Average speed
- ④ Distance covered
- ⑤ Maximum speed



Lap statistics

This function is only available if you have stored at least two laps and have stopped the RACETIMER.

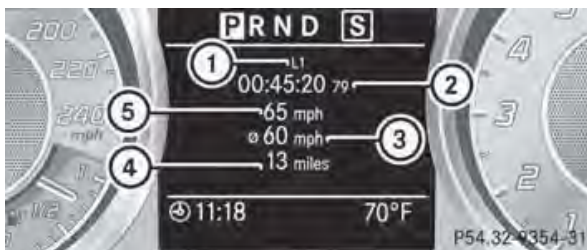
- ▶ Press  or  on the steering wheel to select the **AMG** menu.
- ▶ Press the  button repeatedly until the lap evaluation is shown. Each lap is shown in a separate submenu. The fastest lap is indicated by flashing symbol ①.



- ① Lap
- ② Lap time

- ③ Average lap speed
- ④ Lap length
- ⑤ Top speed during lap
- ▶ Press the  or  button to select a different lap evaluation.

Display messages



Hiding display messages

WARNING

All categories of messages contain important information which should be taken note of and, where a malfunction is indicated, addressed as soon as possible at an authorized Mercedes-Benz Center.

Failure to repair the condition noted may cause damage not covered by the Mercedes-Benz Limited Warranty, or result in property damage or personal injury.

Display messages appear in the multifunction display.

- ▶ Press the  or  button on the steering wheel to hide the display message.
The display message is cleared.







The multifunction display shows high-priority display messages in red.

You cannot hide display messages of the highest priority. The multifunction display shows these messages continuously until the causes for the messages have been remedied.

Certain display messages are accompanied by an audible warning tone or a continuous tone. Please respond in accordance with the display messages and follow the additional notes in this Operator's Manual.











Message memory









The on-board computer saves certain display messages. You can call up the display messages in the **message memory**.





- ▶ Press  or  on the steering wheel to select the **Serv.** menu.
If there are display messages, the multifunction display shows **2 Messages**, for example.
- ▶ Press the  or  button to select the entry, e.g. **2 Messages**.
- ▶ Confirm with .
- ▶ Press the  or  button to scroll through the display messages.





When the ignition is switched off, all display messages are deleted apart from some high-priority display messages. Once the causes of the high-priority display messages have been rectified, the corresponding display messages are also deleted.









Braking

Display messages	Possible causes/consequences and ► Solutions
<p>BRAKE (USA only)  (Canada only)</p> <p>ABS and ESC Currently Unavailable See Operator's Manual</p>	<p>ABS, ESP[®], BAS and hill start assist are temporarily unavailable. For example, the on-board voltage may be insufficient. In addition, the ,  and  warning lamps light up in the instrument cluster.</p> <p>The brake system continues to function normally, but without the functions listed above. The wheels could therefore lock if you brake hard, for example.</p> <p> WARNING</p> <p>If the ABS malfunctions, the wheels may lock during hard braking. This limits the steerability of the vehicle when braking and may increase the braking distance. If ABS is deactivated due to a malfunction, BAS and ESP[®] are also deactivated. There is an increased risk of skidding and an accident.</p> <ul style="list-style-type: none"> ► Drive on carefully. ► Visit a qualified specialist workshop.
<p>BRAKE (USA only)  (Canada only)</p> <p>ABS and ESC Inoperative See Operator's Manual</p>	<p>ABS, ESP[®], BAS and hill start assist are unavailable due to a malfunction. In addition, the ,  and  warning lamps light up in the instrument cluster.</p> <p>The brake system continues to function normally, but without the functions listed above.</p> <p> WARNING</p> <p>If the ABS malfunctions, the wheels may lock during hard braking. This limits the steerability of the vehicle when braking and may increase the braking distance. If ABS is deactivated due to a malfunction, BAS and ESP[®] are also deactivated. There is an increased risk of skidding and an accident.</p> <ul style="list-style-type: none"> ► Drive on carefully. ► Visit a qualified specialist workshop.

Display messages	Possible causes/consequences and ► Solutions
<p>BRAKE (USA only)  (Canada only)</p> <p>EBR, ABS, ESC Inoperative See Operator's Manual</p>	<p>EBD (electronic brake force distribution), ABS, ESP[®], BAS and hill start assist are unavailable due to a malfunction. In addition, the ,  and  warning lamps light up in the instrument cluster and a warning tone sounds.</p> <p>The brake system continues to function normally, but without the functions listed above.</p> <p>⚠ WARNING</p> <p>If EBD and ABS are malfunctioning, the rear wheels in particular could lock under braking. If ABS is deactivated due to a malfunction, BAS and ESP[®] are also deactivated. There is an increased risk of skidding and an accident.</p> <ul style="list-style-type: none"> ► Drive on carefully. ► Visit a qualified specialist workshop immediately.
<p>PARK (USA only)  (Canada only)</p> <p>Please Release Parking Brake</p>	<p> The indicator lamp (red) flashes and a warning tone sounds. You are driving with the electric parking brake applied.</p> <ul style="list-style-type: none"> ► Release the electric parking brake. <p>or</p> <ul style="list-style-type: none"> ► Consult a qualified specialist workshop. <p> The indicator lamp (red) flashes, the warning lamp (yellow) lights up and a warning tone sounds.</p> <p>The electric parking brake is malfunctioning and the braking effect is restricted.</p> <p>While the vehicle is in motion:</p> <ul style="list-style-type: none"> ► Release the electric parking brake handle. <p>While the vehicle is stationary:</p> <ul style="list-style-type: none"> ► Switch off the ignition and turn it back on. ► Release the electric parking brake. <p>If the display message continues to be displayed:</p> <ul style="list-style-type: none"> ► Shift the transmission to P with the button in the center console. ► Prevent the vehicle from rolling away before you leave it. ► Consult a qualified specialist workshop. <p> The indicator lamp (red) flashes and a warning tone sounds. You are making an emergency stop using the electric parking brake.</p> <ul style="list-style-type: none"> ► After the emergency stop: release the electric parking brake lever.

Display messages	Possible causes/consequences and ► Solutions
<p>PARK (USA only)  (Canada only)</p> <p>Parking Brake See Oper. Manual</p>	<p> The warning lamp (yellow) lights up. Additionally the indicator lamp (red) lights up. The electric parking brake is malfunctioning.</p> <p>To release:</p> <ul style="list-style-type: none"> ▶ Pull the electric parking brake handle. or ▶ Pull away carefully. ▶ Visit a qualified specialist workshop. <p>To apply:</p> <ul style="list-style-type: none"> ▶ Switch the ignition off. ▶ Pull the electric parking brake lever for at least ten seconds, until the display message disappears. <p>If the display message continues to be displayed:</p> <ul style="list-style-type: none"> ▶ Shift the transmission to P with the button in the center console. ▶ Prevent the vehicle from rolling away before you leave it. ▶ Consult a qualified specialist workshop.
	<p> The indicator lamp (red) flashes. The power supply for the electric parking brake was interrupted.</p> <ul style="list-style-type: none"> ▶ Pull the electric parking brake handle. or ▶ Pull away carefully. or ▶ Pull the electric parking brake handle until the display message disappears.
	<p> The indicator lamp (red) flashes and the warning lamp (yellow) lights up. The electric parking brake is malfunctioning.</p> <ul style="list-style-type: none"> ▶ Switch off the ignition and turn it back on. ▶ Engage or release the electric parking brake. or ▶ Pull away carefully. ▶ Visit a qualified specialist workshop.

Display messages	Possible causes/consequences and ► Solutions
	<p> The warning lamp (yellow) lights up. In addition, the indicator lamp (red) flashes for about 10 seconds after the electric parking brake has been engaged or released. It then goes out or remains lit.</p> <p>The electric parking brake is malfunctioning, e.g. because of overvoltage or undervoltage.</p> <ul style="list-style-type: none"> ► Pull away carefully. ► Visit a qualified specialist workshop. <p>If there is overvoltage or undervoltage:</p> <ul style="list-style-type: none"> ► Remove the cause for the overvoltage or undervoltage, e.g. by charging the battery or restarting the engine. ► Switch the ignition off and on, and then engage or release the electric parking brake. <p>If this does not release the electric parking brake:</p> <ul style="list-style-type: none"> ► Do not drive on. ► Consult a qualified specialist workshop. <hr/> <p> The warning lamp (yellow) lights up. In addition, the indicator lamp (red) flashes for about 10 seconds after the electric parking brake has been engaged or released. It then goes out or remains lit.</p> <p>The electric parking brake has overheated.</p> <ul style="list-style-type: none"> ► Allow the vehicle to cool down. Do not engage or release the electric parking brake during this time. ► Prevent the vehicle from rolling away before you leave it. ► When the vehicle has cooled down: switch the ignition off and on again, then engage or release the electric parking brake.
<p> (USA only)  (Canada only)</p> <p>Parking Brake Inoperative</p>	<p> The warning lamp (yellow) lights up. In addition, the indicator lamp (red) flashes for about 10 seconds after the electric parking brake has been engaged or released. It then goes out or remains lit.</p> <p>The electric parking brake is malfunctioning.</p> <ul style="list-style-type: none"> ► Switch the ignition off and on, and then engage the electric parking brake. <p>If it is not possible to engage the electric parking brake:</p> <ul style="list-style-type: none"> ► Shift the transmission to P with the button in the center console. ► Prevent the vehicle from rolling away before you leave it. ► Visit a qualified specialist workshop.







Display messages	Possible causes/consequences and ► Solutions
<p> (USA only)  (Canada only)</p> <p>Turn On the Ignition to Release the Parking Brake</p>	<p> The indicator lamp (red) flashes.</p> <p>You attempted to release the electric parking brake while the ignition was switched off.</p> <p>► Switch on the ignition.</p>
<p> (USA only)  (Canada only)</p> <p>Check Brake Fluid Level</p>	<p>There is not enough brake fluid in the brake fluid reservoir. In addition, the  indicator lamp in the instrument cluster lights up and a warning tone sounds.</p> <p> WARNING</p> <p>Driving with the message Check Brake Fluid Level displayed can result in an accident.</p> <p>► Pull over and stop the vehicle safely as soon as possible, paying attention to road and traffic conditions. Do not continue driving under any circumstances.</p> <p>► Consult a qualified specialist workshop.</p> <p>Do not add brake fluid. This does not correct the malfunction.</p>
<p></p> <p>Check Brake Pad Wear</p>	<p>The brake pads/linings have reached their wear limit.</p> <p>► Visit a qualified specialist workshop.</p>







 **WARNING**

Driving with the message [Check Brake Fluid Level](#) displayed can result in an accident. Have your brake system checked immediately.



Do not add brake fluid before checking the brake system. Overfilling the brake fluid reservoir can result in spilling brake fluid on hot engine parts and the brake fluid catching fire. You can be seriously burned.







Safety systems

Display messages	Possible causes/consequences and ► Solutions
 <p>ESC Inoperative See Operator's Manual</p>	<p>ESP[®], BAS and hill start assist are unavailable due to a malfunction. In addition, the  and  warning lamps light up in the instrument cluster.</p> <p>⚠ WARNING</p> <p>If ESP[®] and BAS are deactivated, the danger of skidding and having an accident increases.</p> <ul style="list-style-type: none"> ► Drive on carefully. ► Visit a qualified specialist workshop.
 <p>ESC Currently Unavailable See Operator's Manual</p>	<p>ESP[®], BAS and hill start assist are temporarily unavailable. The self-diagnosis function might not be complete, for example. The brake system continues to function normally, but without the functions listed above. In addition, the  and  warning lamps light up in the instrument cluster.</p> <p>⚠ WARNING</p> <p>If ESP[®] and BAS are deactivated, the danger of skidding and having an accident increases.</p> <ul style="list-style-type: none"> ► Carefully drive a short distance making slight steering movements at a speed above 12 mph (20 km/h) until the display message disappears.
<p>Front Passenger Airbag Enabled See Operator's Manual</p>	<p>The front-passenger air bag and front-passenger knee bag are enabled during the journey, even though:</p> <ul style="list-style-type: none"> • a child, a small adult or an object weighing less than the system's weight threshold is located on the front-passenger seat. • the front-passenger seat is unoccupied. <p>The system may detect objects or forces applying additional weight on the seat.</p> <ul style="list-style-type: none"> ► Pull over and stop the vehicle safely as soon as possible, paying attention to road and traffic conditions. ► Apply the parking brake. ► Switch the ignition off. ► Open the front-passenger door. ► Remove the child and the child restraint system from the front-passenger seat.



Display messages	Possible causes/consequences and ► Solutions
	<p>► Make sure that there are no objects on the seat adding to the weight. The system may otherwise detect the additional weight and interpret the seat occupant's weight as greater than it actually is.</p> <p>► Keep the seat unoccupied, close the front-passenger door and switch on the ignition.</p> <p>Observe the   (► page 42) indicator lamp and the multifunction display and check the following: Seat unoccupied and ignition switched on:</p> <ul style="list-style-type: none"> • the   indicator lamp must light up and remain lit. If the indicator lamp is on, OCS (► page 42) has disabled the front-passenger air bag. • the Front Passenger Airbag Enabled See Operator's Manual or Front Passenger Airbag Disabled See Operator's Manual display messages must not be shown in the multifunction display. Wait for a period of at least 60 seconds until the necessary system checks have been completed. This is necessary to make sure that the display messages do not appear in the multifunction display. <p>If these conditions are fulfilled, the front-passenger seat can be occupied again. Whether the   indicator lamp remains lit or goes out depends on how OCS classifies the occupant. If the conditions are not fulfilled, the system is not operating correctly.</p> <p>► Visit a qualified specialist workshop immediately.</p>





WARNING

If the   indicator lamp remains off even after performing the above corrective steps, do not have any children twelve years old and under and other small individuals use the front-passenger seat until the system has been repaired.

Display messages	Possible causes/consequences and ► Solutions
<p>Front Passenger Airbag Disabled See Operator's Manual</p>	<p>The front-passenger front air bag and the front-passenger knee bag are disabled during the journey even though a person larger than a certain size is occupying the front-passenger seat. If additional forces are applied to the seat, the system may interpret the occupant's weight as lower than it actually is.</p> <ul style="list-style-type: none"> ► Pull over and stop the vehicle safely as soon as possible, paying attention to road and traffic conditions. ► Apply the parking brake. ► Switch the ignition off. ► Have the occupant get out of the vehicle. ► Keep the seat unoccupied, close the front-passenger door and switch on the ignition. <p>Observe the   (► page 42) indicator lamp and the multifunction display and check the following:</p> <p>Seat unoccupied and ignition switched on:</p> <ul style="list-style-type: none"> • the   indicator lamp must light up and remain lit. If the indicator lamp is on, OCS has disabled the front-passenger air bag (► page 42). • the Front Passenger Airbag Enabled See Operator's Manual or Front Passenger Airbag Disabled See Operator's Manual display messages must not be shown in the multifunction display. Wait for a period of at least 60 seconds, until the necessary system checks have been completed. This is necessary and ensures that the display messages do not appear in the multifunction display. <p>If these conditions are fulfilled, the front-passenger seat can be occupied again. Whether the   indicator lamp remains lit or goes out depends on how OCS classifies the occupant.</p> <p>If the conditions are not fulfilled, the system is not operating correctly.</p> <ul style="list-style-type: none"> ► Visit a qualified specialist workshop immediately.

WARNING

If the   indicator lamp remains lit with an adult occupant on the front-passenger seat even after performing the above corrective steps, do not have any passenger use the front-passenger seat until the system has been repaired.

Display messages	Possible causes/consequences and ► Solutions
 <p>Tele Aid Inoperative</p>	<p>One or more main features of the mbrace system are malfunctioning.</p> <ul style="list-style-type: none"> ► Have the mbrace system checked immediately at a qualified specialist workshop.
 <p>SRS Malfunction Service Required</p>	<p>There is a malfunction in the SRS (Supplemental Restraint System). The  warning lamp also lights up in the instrument cluster.</p> <p>⚠ WARNING</p> <p>If SRS is malfunctioning, individual systems may be triggered unintentionally or might not be triggered in the event of an accident with a high rate of vehicle deceleration. In this condition, the restraint system provides only restricted protection.</p> <ul style="list-style-type: none"> ► Visit a qualified specialist workshop.
 <p>Front Left SRS Malfunction Service Required or Front Right SRS Malfunction Service Required</p>	<p>SRS has malfunctioned at the front on the left or right. The  warning lamp also lights up in the instrument cluster.</p> <p>⚠ WARNING</p> <p>If SRS is malfunctioning, individual systems may be triggered unintentionally or might not be triggered in the event of an accident with a high rate of vehicle deceleration. In this condition, the restraint system provides only restricted protection.</p> <ul style="list-style-type: none"> ► Visit a qualified specialist workshop.

⚠ WARNING

In the event a malfunction of the SRS is indicated as outlined above, the SRS may not be operational.

For your safety, we strongly recommend that you contact an authorized Mercedes-Benz Center immediately to have the system checked. Otherwise the SRS may not be activated when needed in an accident, which could result in serious or fatal injury, or it might deploy unexpectedly and unnecessarily which could also result in injury.





Lights

i Display messages about LEDs:

The display message will only appear if all or a number of LEDs have failed.

Display messages	Possible causes/consequences and ► Solutions
 <p>Check Left Low Beam or Check Right Low Beam</p>	<p>The left or right-hand low-beam headlamp does not light up. In addition, the high-beam headlamp is also inoperative.</p> <p>► Visit a qualified specialist workshop.</p>
 <p>AUTO Lamp Function Inoperative</p>	<p>The light sensor is defective.</p> <p>USA only:</p> <p>► Switch off the daytime running lamps in the on-board computer (► page 154).</p> <p>► Switch the lights on and off using the light switch.</p>
 <p>Check Rear Left Turn Signal or Check Rear Right Turn Signal</p>	<p>The LEDs in the rear left or right-hand indicator lamp do not light up.</p> <p>► Visit a qualified specialist workshop.</p>
 <p>Check Left Mirror Turn Signal or Check Right Mirror Turn Signal</p>	<p>None of the LEDs in the left or right-hand exterior mirrors light up.</p> <p>► Visit a qualified specialist workshop.</p>
 <p>Check Front Left Turn Signal or Check Front Right Turn Signal</p>	<p>The LEDs in the front left or right-hand indicator lamp do not light up.</p> <p>► Visit a qualified specialist workshop.</p>
 <p>Check Center Brake Lamp</p>	<p>None of the LEDs in the high-mounted brake lamp light up.</p> <p>► Visit a qualified specialist workshop.</p>

Display messages	Possible causes/consequences and ► Solutions
 <p>Check Left Brake Lamp or Check Right Brake Lamp</p>	<p>The left or right-hand brake light LEDs do not light up. ► Visit a qualified specialist workshop.</p>
 <p>Check Left Tail Lamp or Check Right Tail Lamp</p>	<p>The left or right-hand tail lamp LEDs do not light up. ► Visit a qualified specialist workshop.</p>
 <p>Check Left High Beam or Check Right High Beam</p>	<p>The left or right-hand low-beam headlamp does not light up. ► Visit a qualified specialist workshop.</p>
 <p>Check Left License Plate Lamp or Check Right License Plate Lamp</p>	<p>The left or right-hand license plate lamp does not light up. ► Replace the bulb (► page 97).</p>
 <p>Backup Light</p>	<p>None of the LEDs in the backup lamp light up. ► Visit a qualified specialist workshop.</p>
 <p>Check Left Daytime Running Light or Check Right Daytime Running Light</p>	<p>The LEDs in the left or right-hand daytime running lamp do not light up. As a result, the corresponding side/standing lamp has failed. ► Visit a qualified specialist workshop.</p>

Display messages	Possible causes/consequences and ► Solutions
 <p>Check Front Left Sidemarkers Lamp or Check Front Right Sidemarkers Lamp</p>	<p>The left or right front side marker lamp is defective.</p> <p>► Visit a qualified specialist workshop.</p>
 <p>Check Rear Left Sidemarkers Lamp or Check Rear Right Sidemarkers Lamp</p>	<p>The rear left or right side marker lamp is defective.</p> <p>► Visit a qualified specialist workshop.</p>
 <p>Check Front Left Parking Lamp or Check Front Right Parking Lamp</p>	<p>The front left or front right parking or standing lamp is defective.</p> <p>► Visit a qualified specialist workshop.</p>
 <p>Switch Off Lights</p>	<p>The lights are still switched on when you leave the vehicle. A warning tone also sounds.</p> <p>► Turn the light switch to AUTO.</p>
 <p>Malfunction See Operator's Manual</p>	<p>The exterior lighting is defective.</p> <p>► Visit a qualified specialist workshop.</p>

Engine

WARNING



Driving when your engine is overheated can cause some fluids which may have leaked into the engine compartment to catch fire. You could be seriously burned.



Steam from an overheated engine can cause serious burns which can occur just by opening the engine hood. Stay away from the engine if you see or hear steam coming from it.







Stop the vehicle in a safe location away from other traffic. Turn off the engine, get out of the vehicle and do not stand near the vehicle until the engine has cooled down.



WARNING

Do not spill antifreeze on hot engine parts. Antifreeze contains ethylene glycol which may burn if it comes into contact with hot engine parts. You could be seriously burned.

Display messages	Possible causes/consequences and ► Solutions
 <p>Coolant Low Stop Vehicle Turn Engine Off</p>	<p>The coolant is too hot. In addition, the  warning lamp in the instrument cluster lights up and a warning tone sounds.</p> <ul style="list-style-type: none"> ▶ Pull over and stop the vehicle safely and switch off the engine, paying attention to road and traffic conditions. ▶ Make sure that the air supply to the radiator is not blocked, e.g. by snow, slush or ice. ▶ Wait until the display message disappears before restarting the engine. Otherwise, the engine could be damaged. ▶ Pay attention to the coolant temperature display. ▶ If the coolant temperature increases again, visit a qualified specialist workshop immediately. <p>! If the coolant temperature is over 248 °F (120 °C), do not continue driving. The engine will otherwise be damaged.</p> <p>The poly-V-belt may have torn. A warning tone also sounds.</p> <ul style="list-style-type: none"> ▶ Pull over and stop the vehicle safely and switch off the engine, paying attention to road and traffic conditions. ▶ Check the poly-V-belt. ▶ If the poly-V-belt is not damaged: do not start the engine again until the display message disappears. Otherwise, the engine could be damaged. ▶ If the poly-V-belt is torn: do not continue driving. Consult a qualified specialist workshop.
	<p>The engine fan is defective.</p> <ul style="list-style-type: none"> ▶ At coolant temperatures below 248 °F (120 °C), drive to the nearest qualified specialist workshop. ▶ Avoid subjecting the engine to heavy loads (e.g. driving in mountainous terrain) and stop-and-go driving.

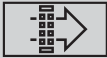

Display messages	Possible causes/consequences and ► Solutions
	<p>The battery is not being charged. A warning tone also sounds. Possible causes are:</p> <ul style="list-style-type: none"> • a defective alternator • a torn poly-V-belt • a malfunction in the electronics <p>► Pull over and stop the vehicle safely paying attention to road and traffic conditions and switch off the engine.</p> <p>► Open the hood.</p> <p>► Check whether the poly-V-belt is torn.</p> <p>If the poly-V-belt is torn:</p> <p>! Do not continue driving. The engine could otherwise overheat.</p> <p>► Consult a qualified specialist workshop.</p> <p>If the poly-V-belt is not damaged:</p> <p>► Visit a qualified specialist workshop.</p>
 <p>Check Coolant Level See Operator's Manual</p>	<p>The coolant level is too low.</p> <ul style="list-style-type: none"> ► Add coolant, observing the warning notes before doing so (► page 216). ► If coolant needs to be added more often than usual, have the engine coolant system checked at a qualified specialist workshop. <p>! The coolant level is too low. Avoid making long journeys with too little coolant in the cooling system. The engine will otherwise be damaged.</p> <p>The display messages and the corresponding symbol that indicate that the coolant level is too low must not be ignored.</p>
 <p>Engine Oil Level Low Stop Vehicle Turn Engine Off</p>	<p>There is insufficient oil in the engine. There is a risk of engine damage.</p> <ul style="list-style-type: none"> ► Pull over and stop the vehicle safely and switch off the engine, paying attention to road and traffic conditions. ► Top up and check the engine oil level (► page 215).

Display messages	Possible causes/consequences and ► Solutions
 <p>Check Engine Oil Level (Add 1 Liter)</p>	<p>The oil level is too low.</p> <ul style="list-style-type: none"> ► Check the oil level (▷ page 215). ► If necessary, add engine oil. ► Have the engine checked for leaks if you need to add engine oil more often than usual. <p>Information on approved engine oils can be obtained from any qualified specialist workshop or on the Internet at http://www.mbusa.com (USA only).</p> <p>! The oil level is too low. Avoid long journeys with too little engine oil. There is a risk of engine damage.</p> <p>The display messages and the corresponding symbol that indicate that the oil level is too low must not be ignored.</p>
 <p>Engine Oil Level Too High</p>	<p>You have added too much engine oil. The engine or catalytic converter may be damaged.</p> <ul style="list-style-type: none"> ► Siphon off excess engine oil until it is at the specified level. Observe the legal requirements.
 <p>Engine Oil Level Cannot Be Measured</p>	<p>The measuring system is faulty.</p> <ul style="list-style-type: none"> ► Visit a qualified specialist workshop.
 <p>Engine Oil Pressure Control See Operator's Manual</p>	<p>The oil pressure sensor has reported a malfunction. The oil pressure control is in emergency mode. The engine lubrication is guaranteed.</p> <ul style="list-style-type: none"> ► Visit a qualified specialist workshop.
 <p>Engine Oil Pressure Stop Vehicle Turn Engine Off</p>	<ul style="list-style-type: none"> ► Pull over and stop the vehicle safely and switch off the engine, paying attention to road and traffic conditions. ► Check the engine oil level (▷ page 215) and top up if necessary. ► If there are visible signs of oil loss from the vehicle, consult a qualified specialist workshop.
 <p>Fuel Level Low</p>	<p>There is only a small amount of fuel in the fuel tank.</p> <ul style="list-style-type: none"> ► Refuel at the nearest gas station.
 <p>Fuel Level Low</p>	<p>The fuel level has fallen below the reserve range.</p> <ul style="list-style-type: none"> ► Refuel at the nearest gas station.

Display messages	Possible causes/consequences and ► Solutions
 Gas Cap Loose	<p>The fuel system pressure is too low. The fuel filler cap is not closed correctly or the fuel system is leaking.</p> <ul style="list-style-type: none"> ► Check that the fuel filler cap is correctly closed. <p>If the fuel filler cap is not correctly closed:</p> <ul style="list-style-type: none"> ► Close the fuel filler cap. <p>If the fuel filler cap is correctly closed:</p> <ul style="list-style-type: none"> ► Visit a qualified specialist workshop.
 Replace Air Filter	<p>The air filter is dirty and must be replaced.</p> <ul style="list-style-type: none"> ► Visit a qualified specialist workshop.
 Check Fuel Filter	<p>Vehicles with a diesel engine: there is water in the fuel filter. The water must be drained off.</p> <ul style="list-style-type: none"> ► Visit a qualified specialist workshop.

Driving systems

Display messages	Possible causes/consequences and ► Solutions
Cruise Control Inoperative	<p>Cruise control is defective.</p> <p>A warning tone also sounds.</p> <ul style="list-style-type: none"> ► Visit a qualified specialist workshop.
Cruise Control --- mph	<p>A condition for activating cruise control has not been fulfilled. You attempted to save a speed of less than 20 mph (30 km/h).</p> <ul style="list-style-type: none"> ► Activate ESP® (► page 56). ► If the situation allows, drive faster than 20 mph (30 km/h) and save the speed. ► Check the activation conditions for cruise control (► page 134).

Display messages	Possible causes/consequences and ► Solutions
Blind Spot Assist Inoperative	<p>Blind Spot Assist is defective.</p> <p>The yellow  indicator lamps also light up in the exterior mirrors.</p> <p>► Visit a qualified specialist workshop.</p>
Blind Spot Assist Currently Unavailable See Operator's Manual	<p>Blind Spot Assist is temporarily inoperative if:</p> <ul style="list-style-type: none"> • the sensors are dirty. • its function is impaired due to heavy rain or snow. • the radar sensor system is outside the operating temperature range. • the radar sensor system is temporarily inoperative, e.g. due to electromagnetic radiation emitted by nearby TV or radio stations or other sources of electromagnetic radiation. <p>The yellow  indicator lamps also light up in the exterior mirrors.</p> <p>Blind Spot Assist is operational again and the display message disappears if:</p> <ul style="list-style-type: none"> • the dirt (e.g. slush) drops away while the vehicle is in motion. • the system detects that the sensors are fully available again. • the radar sensor system is back within the operating temperature range. <p>If the display message continues to be displayed:</p> <p>► Clean the sensors (► page 224).</p> <p>► Restart the engine.</p>

Tires

WARNING

Tires with tire pressures that are too low or too high are associated with the following hazards:



- they can burst, in particular if the vehicle is heavily laden or when driven at high speeds.
- the tires can wear excessively and/or unevenly, which can severely impair tire traction.
- the driving, steering and braking characteristics may be severely impaired.





There is a risk of accident.

Follow recommended tire inflation pressures and check the pressure of all the tires including the spare wheel:









- monthly, at least
- if the load changes
- before beginning a long journey
- under different operating conditions, e.g. off-road driving



If necessary, correct the tire pressure.

Display messages	Possible causes/consequences and ► Solutions
Tire Press. Monitor Inoperative	The tire pressure monitor is faulty. ► Visit a qualified specialist workshop.
Tire Pressure Monitor Inoperative No Wheel Sensors	The wheels mounted do not have a suitable tire pressure sensor. The tire pressure monitor is deactivated. ► Mount wheels with suitable tire pressure sensors. The tire pressure monitor is activated automatically after driving for a few minutes.
Check Tires	The tire pressure in one or more tires has dropped significantly. The wheel position is shown in the multifunction display. A warning tone also sounds.  WARNING Insufficient tire pressure can cause the tires to burst. the driving characteristics, as well as steering and braking, may be greatly impaired. There is a risk of an accident. ► Stop the vehicle without making any sudden steering or braking maneuvers. Pay attention to the traffic conditions as you do so. ► Correct the tire pressure (▷ page 255). ► If necessary, change the wheel (▷ page 269).
Tire Press. Warning Caution Tire Malfunction	The tire pressure in one or more tires has dropped suddenly. The wheel position is shown in the multifunction display. A warning tone also sounds.  WARNING Insufficient tire pressure can cause the tires to burst. the driving characteristics, as well as steering and braking, may be greatly impaired. There is a risk of an accident. ► Stop the vehicle without making any sudden steering or braking maneuvers. Pay attention to the traffic conditions as you do so. ► If necessary, change the wheel (▷ page 269).
Correct Tire Pressure	The tire pressure is too low in at least one of the tires, or the tire pressure difference between the wheels is too great. ► Check the tire pressures at the next opportunity. If necessary, correct the tire pressure (▷ page 255).
TirePress. Sensor(s)Missing	There is no signal from the tire pressure sensor of one or several wheels. The pressure of the affected tire is not displayed in the multifunction display. ► Have the faulty tire pressure sensor replaced at a qualified specialist workshop.



Display messages	Possible causes/consequences and ► Solutions
Tire Press. Monitor Currently Unavailable	<p>Due to a source of radio interference, no signals can be received from the wheel sensors. The tire pressure monitor is temporarily malfunctioning.</p> <ul style="list-style-type: none"> ► Drive on. The tire pressure monitor restarts automatically as soon as the problem has been solved.
 <p>Tire Press. Warning Caution Tire Malfunction</p>	<p>The tire pressure in one or more tires has dropped suddenly. A warning tone also sounds.</p> <p> WARNING</p> <p>Insufficient tire pressure can cause the tires to burst. the driving characteristics, as well as steering and braking, may be greatly impaired. There is a risk of an accident.</p> <ul style="list-style-type: none"> ► Stop the vehicle without making any sudden steering or braking maneuvers. Pay attention to the traffic conditions as you do so. ► Repair the faulty tire or change the wheel (► page 269).
 <p>Check Tire Pressure</p>	<p>The tire pressure in one or more tires has dropped significantly. A warning tone also sounds.</p> <p> WARNING</p> <p>Insufficient tire pressure can cause the tires to burst. the driving characteristics, as well as steering and braking, may be greatly impaired. There is a risk of an accident.</p> <ul style="list-style-type: none"> ► Stop the vehicle without making any sudden steering or braking maneuvers. Pay attention to the traffic conditions as you do so. ► Correct the tire pressure (► page 255). ► If necessary, repair the faulty tire or change the wheel (► page 269).







Vehicle

Display messages	Possible causes/consequences and ► Solutions
	The trunk lid is open. ► Close the trunk lid.
	The hood is open. ⚠ WARNING The open hood may block your view when the vehicle is in motion. There is a risk of an accident. ► Pull over and stop the vehicle safely as soon as possible, paying attention to road and traffic conditions. ► Close the hood.
 (Coupe only)  (Roadster only)	At least one door is open. ► Close the doors.
 Convertible Top Operation Possible to 31 mph	If you drive at speeds of more than 31 mph (50 km/h), you cannot open or close the soft top. ► Fully open or close the soft top (▷ page 77).
 Convertible Top Opening/Closing Not Finished	The soft top is not fully opened or closed. The hydraulics are depressurized. ► Fully open or close the soft top (▷ page 77).
 Open/Close Convertible Top Completely	The roof is not locked. If you drive at speeds of more than 31 mph (50 km/h), you cannot open or close the soft top. ► If you are driving at speeds of more than 31 mph (50 km/h), reduce your speed. ► Push or pull the soft-top switch (▷ page 77) until the soft top is fully open or closed.
 Convertible Top in Operation Please Wait	The on-board voltage is too low. ► Start the engine.

Display messages	Possible causes/consequences and ► Solutions
	<p>The soft top has been opened and closed several times in a row. The soft-top drive has been switched off automatically for safety reasons.</p> <p>You can open and close the soft top again after approximately ten minutes.</p> <ul style="list-style-type: none"> ► Switch off the ignition and turn it back on. ► Repeat the opening or closing procedure (▷ page 77).
 Depress Brake	<p>You have attempted to close the soft top with the soft top switch while the vehicle was stationary.</p> <ul style="list-style-type: none"> ► Depress the brake pedal. ► Press the soft-top switch until the soft top is completely closed.
 Check Washer Fluid	<p>The washer fluid level in the washer fluid reservoir has dropped below the minimum.</p> <ul style="list-style-type: none"> ► Add washer fluid (▷ page 217).

SmartKey





Display messages	Possible causes/consequences and ► Solutions
 Replace Key Battery	<p>The SmartKey batteries are discharged.</p> <ul style="list-style-type: none"> ► Change the batteries (▷ page 64).
 Key Not Detected (red display message)	<p>The SmartKey is not in the vehicle. A warning tone also sounds. When you switch off the engine, you will be unable to restart it.</p> <ul style="list-style-type: none"> ► Pull over and stop the vehicle safely as soon as possible, paying attention to road and traffic conditions. ► Locate the SmartKey. <p>The SmartKey is not detected while driving because a powerful radio transmitter is causing interference. A warning tone also sounds.</p> <ul style="list-style-type: none"> ► Pull over and stop the vehicle safely as soon as possible, paying attention to road and traffic conditions. ► Insert the SmartKey into the ignition lock and turn it to the desired position (▷ page 113).

Display messages	Possible causes/consequences and ► Solutions
 Key Not Detected (white display message)	You are in the vehicle and the SmartKey currently cannot be detected by the vehicle. ► Change the location of the SmartKey in the vehicle. If the SmartKey still cannot be detected: ► Insert the SmartKey into the ignition lock and turn it to the desired position (▷ page 113).
 Obtain a New Key	The SmartKey needs to be replaced. ► Visit a qualified specialist workshop.
 Key Does Not Belong to Vehicle	You have put the wrong SmartKey in the ignition lock. ► Use the correct SmartKey.
 Close Doors to Lock Vehicle	At least one door is open. A warning tone also sounds. ► Close all doors and lock the vehicle again.
 Insert Key	The KEYLESS-GO start function is temporarily malfunctioning or is defective. A warning tone also sounds. ► Insert the SmartKey into the ignition lock and turn it to the desired position (▷ page 113).
 Take Your Key From Ignition	The SmartKey is in the ignition lock. ► Remove the SmartKey.



Transmission

Display messages	Possible causes/consequences and ► Solutions
Apply Brake to Shift from 'P'	You have attempted to move the transmission selector lever to position D , R or N without depressing the brake pedal. ► Depress the brake pedal.
Apply Brake and Start Engine to Disengage 'P'	When the engine is switched off, it is not possible to shift out of park position P . ► Depress the brake pedal and start the engine.
Start Engine to Engage Gear	The gear cannot be engaged when the engine is switched off. ► Depress the brake pedal and start the engine.

Display messages	Possible causes/consequences and ► Solutions
Depress Brake to Start Engine	<p>You cannot start the engine. The engine was switched off in position D or R.</p> <ul style="list-style-type: none"> ► Depress the brake pedal and start the engine.
Door Open Vehicle Not in 'P'	<p>The driver's door is open and the transmission is in position R, N or D.</p> <p>A warning tone also sounds.</p> <ul style="list-style-type: none"> ► Shift the transmission to P with the button in the center console. ► Press the electric parking brake handle.
Service Required Do Not Shift Gears Visit Dealer	<p>You cannot change gear due to a malfunction.</p> <p>A warning tone also sounds.</p> <p>If transmission position D is selected:</p> <ul style="list-style-type: none"> ► Do not switch off the engine. ► Drive to a qualified specialist workshop without shifting the transmission from position D. <p>If transmission position R, N or P is selected:</p> <ul style="list-style-type: none"> ► Make sure that the electric parking brake is applied. ► Prevent the vehicle from rolling away before you leave it (► page 232). ► Notify a qualified specialist workshop or breakdown service. <p>If no transmission position and no drive program is displayed:</p> <ul style="list-style-type: none"> ► Make sure that the electric parking brake is applied. ► Prevent the vehicle from rolling away before you leave it (► page 232). ► Notify a qualified specialist workshop or breakdown service.
Only Shift to 'P' when Vehicle is Stationary	<p>The vehicle is moving.</p> <ul style="list-style-type: none"> ► Pull over and stop the vehicle safely as soon as possible, paying attention to road and traffic conditions. ► Shift the transmission to P with the button in the center console.
Reversing Not Poss. Service Required	<p>The sub geartrain with the even gears has failed. You can no longer engage reverse gear. The smoothness of the gear change is restricted. The transmission is in emergency mode.</p> <ul style="list-style-type: none"> ► Visit a qualified specialist workshop.







Display messages	Possible causes/consequences and ► Solutions
 <p>Parking Lock Malfunct. Apply Parking Brake</p>	<p>Transmission position P cannot be selected.</p> <ul style="list-style-type: none"> ► Make sure that the electric parking brake is applied. ► Prevent the vehicle from rolling away before you leave it (▷ page 232). ► Visit a qualified specialist workshop. Have the vehicle transported on a recovery vehicle or towed with the rear axle raised (▷ page 242).
 <p>Stop Engage P</p>	<p>The transmission is faulty. The vehicle loses drive and rolls to a standstill.</p> <ul style="list-style-type: none"> ► Pull over and stop the vehicle safely as soon as possible, paying attention to road and traffic conditions. ► Make sure that the electric parking brake is applied. ► Prevent the vehicle from rolling away before you leave it (▷ page 232). ► Consult a qualified specialist workshop.
 <p>Transmission Oil Cooling Malfunction</p>	<p>The transmission coolant pump is faulty. The transmission may overheat.</p> <ul style="list-style-type: none"> ► In the on-board computer, select the AMG menu and check the transmission oil temperature. ► Avoid excessive loading, e.g. due to dynamic driving. ► If the transmission oil temperature is less than 248 °F (120 °C), you can continue driving to the nearest qualified specialist workshop.
 <p>Trans. Oil Overheated Drive on with Care</p>	<p>The transmission oil has overheated.</p> <p>Manual drive program M and shift range restriction are no longer available. Only drive program C is still available. The engine output is reduced according to the degree of overheating.</p> <ul style="list-style-type: none"> ► Allow the transmission oil to cool by adopting a defensive driving style.

Rear spoiler

Display messages	Possible causes/consequences and ► Solutions
 <p>Rear Spoiler Control System Inoperative</p>	<p>The rear spoiler cannot be fully retracted and may extend again. If the retraction of the rear spoiler is blocked, e.g. by ice:</p> <ul style="list-style-type: none"> ► Make sure that the cause of the block is eliminated. ► Switch off the engine and lock the vehicle. ► Start the vehicle after waiting a few minutes. The rear spoiler returns to the original position. <p>If this problem persists or the cause cannot be identified:</p> <ul style="list-style-type: none"> ► Visit a qualified specialist workshop.
 <p>Rear Spoiler Inoperative Limit 200 km/h</p>	<p>The rear spoiler cannot be fully extended and extends as far as possible. The speed of the vehicle is limited to 125 mph(200 km/h). If the extension/retraction of the rear spoiler is blocked, e.g. by ice:</p> <ul style="list-style-type: none"> ► Make sure that the cause of the block is eliminated. ► Switch off the engine and lock the vehicle. ► Start the vehicle after waiting a few minutes. The rear spoiler returns to the original position. <p>If this problem persists or the cause cannot be identified:</p> <ul style="list-style-type: none"> ► Visit a qualified specialist workshop.

Warning and indicator lamps in the instrument cluster

Braking







Problem	Possible causes/consequences and ► Solutions
<p> The red brake system warning lamp comes on while the engine is running. A warning tone also sounds.</p> <p>(USA only)</p> <p> (Canada only)</p>	<p>There is not enough brake fluid in the brake fluid reservoir.</p> <p> WARNING</p> <p>Driving with the red warning lamp displayed could lead to an accident.</p> <ul style="list-style-type: none"> ► Pull over and stop the vehicle safely as soon as possible, paying attention to road and traffic conditions. Do not continue driving under any circumstances. ► Consult a qualified specialist workshop immediately. ► Observe the additional display messages in the multifunction display (► page 161). <p>Do not add brake fluid. This does not correct the malfunction.</p>
<p> The indicator lamp for the electric parking brake flashes and/or the yellow warning lamp for the electric parking brake lights up.</p> <p>(USA only)</p> <p> (Canada only)</p>	<p>The electric parking brake is temporarily malfunctioning or defective.</p> <p> WARNING</p> <p>In this condition, the vehicle is only of limited roadworthiness. This can lead to an accident.</p> <ul style="list-style-type: none"> ► Observe the additional display messages in the multifunction display.



 **WARNING**

Driving with the brake warning lamp illuminated can result in an accident. Have your brake system checked immediately if the brake warning lamp stays on. Do not add brake fluid before checking the brake system.







Overfilling the brake fluid reservoir can result in spilling brake fluid on hot engine parts and the brake fluid catching fire. You can be seriously burned.







Seat belts

Problem	Possible causes/consequences and ► Solutions
 After starting the engine, the red seat belt warning lamp lights up for six seconds.	The seat belt warning lamp reminds the driver and front passenger to fasten their seat belts. ► Fasten your seat belt (▷ page 49).
 After the engine starts, a warning tone sounds for up to six seconds.	The driver's seat belt is not fastened.  WARNING If you do not wear the seat belt correctly, it no longer offers the intended level of protection in the event of an accident. Under certain circumstances, this could cause severe or even fatal injuries in the event of an accident. ► Fasten your seat belt (▷ page 49). The warning tone ceases.
 The red seat belt warning lamp lights up after the engine starts, as soon as the driver's door or the front-passenger door is closed.	The driver or front passenger has not fastened their seat belt.  WARNING If you do not wear the seat belt correctly, it no longer offers the intended level of protection in the event of an accident. Under certain circumstances, this could cause severe or even fatal injuries in the event of an accident. ► Fasten your seat belt (▷ page 49). The warning lamp goes out. There are objects on the front-passenger seat.  WARNING If you place objects on the front-passenger seat, the system could identify the seat as being occupied. In the event of an accident, the restraint systems on the front-passenger side are triggered. ► Remove the objects from the front-passenger seat and stow them in a secure place. The warning lamp goes out.

Problem	Possible causes/consequences and ► Solutions
 The red seat belt warning lamp flashes and an intermittent audible warning sounds.	<p>The driver or front passenger has not fastened their seat belt. The vehicle is being driven faster than 15 mph(25 km/h) or has briefly been driven faster than 15 mph(25 km/h).</p> <p> WARNING</p> <p>If you do not wear the seat belt correctly, it no longer offers the intended level of protection in the event of an accident. Under certain circumstances, this could cause severe or even fatal injuries in the event of an accident.</p> <p>► Fasten your seat belt (► page 49). The warning lamp goes out and the intermittent audible warning ceases.</p> <p>There are objects on the front-passenger seat. The vehicle is being driven faster than 15 mph(25 km/h) or has briefly been driven faster than 15 mph(25 km/h).</p> <p> WARNING</p> <p>If you place objects on the front-passenger seat, the system could identify the seat as being occupied. In the event of an accident, the restraint systems on the front-passenger side are triggered.</p> <p>► Remove the objects from the front-passenger seat and stow them in a secure place. The warning lamp goes out and the intermittent audible warning ceases.</p>

Safety systems

Problem	Possible causes/consequences and ► Solutions
<p> The yellow ABS warning lamp is lit while the engine is running.</p>	<p>ABS has been deactivated due to a malfunction. ESP[®], BAS and hill start assist are therefore also deactivated.</p> <p>The brake system continues to function normally, but without the functions listed above. The wheels could therefore lock if you brake hard, for example.</p> <p> WARNING</p> <p>If the ABS malfunctions, the wheels may lock during hard braking. This limits the steerability of the vehicle when braking and may increase the braking distance. If ABS is deactivated due to a malfunction, then BAS, ESP[®] and hill start assist are also deactivated. There is an increased risk of skidding and an accident.</p> <ul style="list-style-type: none"> ► Observe the additional display messages in the multifunction display (▷ page 166). ► Drive on carefully. ► Visit a qualified specialist workshop.
<p>   The yellow ESP[®] and ESP[®] OFF warning lamps and the yellow ABS warning lamp are lit while the engine is running.</p>	<p>ABS and ESP[®] are malfunctioning. Other systems, e.g. BAS and hill start assist, are unavailable due to a malfunction. The brake system continues to function normally, but without the functions listed above. The wheels could therefore lock if you brake hard, for example.</p> <p> WARNING</p> <p>If ABS and ESP[®] are defective, the wheels could lock when braking. This limits the steerability of the vehicle when braking and may increase the braking distance. If ABS and ESP[®] are defective, Brake Assist and hill start assist are deactivated. There is an increased risk of skidding and an accident.</p> <ul style="list-style-type: none"> ► Observe the additional display messages in the multifunction display (▷ page 166). ► Drive on carefully. ► Visit a qualified specialist workshop.



Problem	Possible causes/consequences and ► Solutions
 The yellow ESP [®] warning lamp flashes while the vehicle is in motion.	ESP [®] or traction control has intervened because there is a risk of skidding or at least one wheel has started to spin. <ul style="list-style-type: none"> ► When pulling away, only depress the accelerator pedal as far as necessary. ► Release the accelerator pedal while the vehicle is in motion. ► Adapt your driving style to suit the road and weather conditions. ► Do not deactivate ESP[®]. For exceptions, see: (► page 56).
 The yellow SPORT handling mode warning lamp is lit while the engine is running.	SPORT handling mode is activated. ESP [®] only stabilizes the vehicle in extreme situations. ESP [®] intervention may not be able to provide enough assistance in such situations, and the vehicle may start to skid. <p> WARNING</p> There is an increased risk of skidding and an accident. <ul style="list-style-type: none"> ► Reactivate ESP[®]. For exceptions, see: (► page 56).
 The yellow ESP [®] and ESP [®] OFF warning lamps are lit while the engine is running.	ESP [®] is not available due to a malfunction. ESP [®] will not stabilize the vehicle if it starts to skid or if a wheel starts to spin. The brake system continues to function normally, but without ESP [®] . <p> WARNING</p> If ESP [®] is unavailable due to a malfunction, the danger of skidding and having an accident increases. <ul style="list-style-type: none"> ► Drive on carefully. ► Visit a qualified specialist workshop.
 The red SRS warning lamp is lit while the engine is running.	The restraint systems are malfunctioning. The air bags or ETDs may either be triggered unintentionally or, in the event of an accident, not be triggered at all. <p> WARNING</p> If the air bags or Emergency Tensioning Devices are either triggered unintentionally or, in the event of an accident, are not triggered, there is an increased risk of injury. <ul style="list-style-type: none"> ► Visit a qualified specialist workshop immediately.



 **WARNING**

In the event a malfunction of the SRS is indicated as outlined above, the SRS may not be operational.

For your safety, we strongly recommend that you contact an authorized Mercedes-Benz Center immediately to have the system checked. Otherwise the SRS may not be activated when needed in an accident, which could result in serious or fatal injury, or it might deploy unexpectedly and unnecessarily which could also result in injury.

Engine

Problem	Possible causes/consequences and ► Solutions
 The yellow Check Engine warning lamp lights up while the engine is running.	There may be a malfunction, for example: <ul style="list-style-type: none"> • in the engine management • in the fuel injection system • in the exhaust system • in the ignition system The emission limit values may be exceeded and the engine may be in emergency mode. <ul style="list-style-type: none"> ► Have the vehicle checked as soon as possible at a qualified specialist workshop. <p>i In some states, you must visit a qualified specialist workshop as soon as the yellow check engine warning lamp lights up. This is due to the legal requirements in effect in these states. If in doubt, check whether such legal regulations apply in the state in which you are currently driving.</p>
 The yellow Check Engine warning lamp lights up while the engine is running. The smoothness of the gear change is restricted.	The sub geartrain with the odd gears has failed. The transmission is in emergency mode. <ul style="list-style-type: none"> ► Have the vehicle checked as soon as possible at a qualified specialist workshop.
 The red engine oil temperature warning lamp comes on while the engine is running. A warning tone also sounds.	The engine oil temperature has exceeded 284 °F(140 °C). The engine is not being cooled sufficiently and may be damaged. <ul style="list-style-type: none"> ► Pull over and stop the vehicle safely and switch off the engine, paying attention to road and traffic conditions. ► Allow the engine to cool down.

Problem	Possible causes/consequences and ► Solutions
 The red engine oil temperature warning lamp comes on while the engine is running. The engine oil temperature is not displayed.	The engine control unit data transfer is malfunctioning. ► Visit a qualified specialist workshop.
 The yellow reserve fuel warning lamp lights up while the engine is running.	The fuel level has dropped into the reserve range. ► Refuel at the nearest gas station.
 The yellow reserve fuel warning lamp flashes while the engine is running.	The fuel system pressure is too low. The fuel filler cap is not closed correctly or the fuel system is leaking. ► Check that the fuel filler cap is correctly closed. ► If the fuel filler cap is not correctly closed: close the fuel filler cap. ► If the fuel filler cap is closed: visit a qualified specialist workshop.

WARNING



Driving when your engine is overheated can cause some fluids which may have leaked into the engine compartment to catch fire. You could be seriously burned.

Steam from an overheated engine can cause serious burns which can occur just by opening the engine hood. Stay away from the engine if you see or hear steam coming from it.

Stop the vehicle in a safe location away from other traffic. Turn off the engine, get out of the vehicle and do not stand near the vehicle until the engine has cooled down.

! If the coolant temperature exceeds 248 °F (120 °C) do not continue driving. The engine will otherwise be damaged.

Tires

Problem	Possible causes/consequences and ► Solutions
<p></p> <p>USA only: The yellow tire pressure monitor warning lamp (pressure loss/malfunction) is lit.</p> <p>Canada only: The yellow tire pressure monitor warning lamp (pressure loss) is lit.</p>	<p>The tire pressure monitor has detected a loss of pressure in at least one of the tires.</p> <p> WARNING</p> <p>Insufficient tire pressure can cause the tires to burst. the driving characteristics, as well as steering and braking, may be greatly impaired. There is a risk of an accident.</p> <ul style="list-style-type: none"> ► Stop the vehicle without making any sudden steering or braking maneuvers. Pay attention to the traffic conditions as you do so. ► Observe the additional display messages in the multifunction display. ► Check the tire pressure. If necessary, correct the tire pressure (▷ page 255). ► If necessary, change the wheel (▷ page 269).
<p></p> <p>USA only: The yellow tire pressure monitor warning lamp (pressure loss/malfunction) flashes for 60 seconds and then remains lit.</p>	<p>The tire pressure monitor is faulty.</p> <ul style="list-style-type: none"> ► Observe the additional display messages in the multifunction display. ► Visit a qualified specialist workshop.

 **WARNING**

Each tire, including the spare (if provided), should be checked at least every two weeks when cold and inflated to the pressure recommended by the vehicle manufacturer on the Tire and Loading Information placard on the driver's door B-pillar or, if available, the tire pressure label on the inside of the fuel filler flap. If your vehicle has tires of a different size than the size indicated on the Tire and Loading Information placard or the tire pressure label, you should determine the proper tire pressure for those tires.

As an added safety feature, your vehicle has been equipped with a tire pressure monitoring system (TPMS) that illuminates a low tire pressure telltale when one or more of your tires are significantly underinflated. Accordingly, when the low tire pressure telltale illuminates, you should stop and check your tires as soon as possible, and inflate them to the proper pressure. Driving on a significantly underinflated tire causes the tire to overheat and can lead to tire failure.

Underinflation also reduces fuel efficiency and tire tread life, and may affect the vehicle's handling and stopping ability. Please note that the TPMS is not a substitute for proper tire maintenance, and it is the driver's responsibility to maintain correct tire pressure, even if underinflation has not reached the level to trigger illumination of the TPMS low tire pressure telltale.

USA only:

Your vehicle has also been equipped with a TPMS malfunction indicator to indicate when the system is not operating properly. The TPMS malfunction indicator is combined with the low tire pressure telltale. When the system detects a malfunction, the telltale will flash for approximately 1 minute and then remain continuously illuminated. This sequence will be repeated every time the vehicle is started as long as the malfunction exists. When the malfunction indicator is illuminated, the system may not be able to detect or signal low tire pressure as intended.

TPMS malfunctions may occur for a variety of reasons, including the installation of incompatible replacement or alternate tires or wheels on the vehicle that prevent the TPMS from functioning properly. Always check the TPMS malfunction telltale after replacing one or more tires or wheels on your vehicle to ensure that the replacement or alternate tires and wheels allow the TPMS to continue to function properly.

Useful information	196
Stowage areas	196
Features	198

Useful information

- i** This Operator's Manual describes all models and all standard and optional equipment of your vehicle available at the time of publication of the Operator's Manual. Country-specific differences are possible. Please note that your vehicle may not be equipped with all features described. This also applies to safety-related systems and functions.
- i** Please read the information on qualified specialist workshops (▷ page 22).

Stowage areas

Stowage space

Important safety notes

WARNING

If you do not correctly store objects in the vehicle interior, they can slip or be flung around, thus striking vehicle occupants. There is a risk of injury, especially when braking or abruptly changing directions.

- Always store objects so that they cannot be flung around in these or in similar situations.
- Always make sure that objects do not protrude from stowage compartments, parcel nets or stowage nets.
- Close lockable stowage compartments while driving.
- Stow and secure objects that are heavy, hard, pointy, sharp-edged, fragile or too large in the trunk.

Glove box

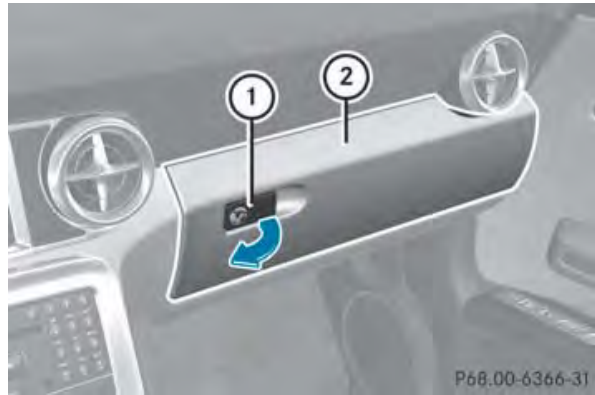

- ▶ **To open:** pull handle ① and open glove box flap ②.
- ▶ **To close:** fold glove box flap ② upwards until it engages.

The glove box can be locked and unlocked using the mechanical key, e.g. when leaving your vehicle at a workshop.

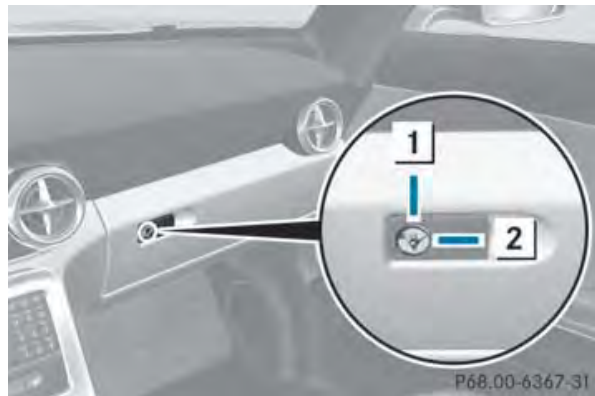

- ▶ **To lock:** insert the mechanical key into the lock and turn it 90° clockwise to position ②.
- ▶ **To unlock:** insert the mechanical key into the lock and turn it 90° counter-clockwise to position ①.

i Roadster: the glove box can be locked and unlocked centrally using the SmartKey (▷ page 62).

i Depending on the vehicle's equipment, you will find an AUX IN jack or a Media Interface installed in the glove box. A Media Interface is a universal interface for portable audio equipment, e.g. for an

iPod® or USB device (see the separate COMAND operating instructions).

- ① There is a 12 V power socket located in the glove box.

Stowage compartment in the center console



► **To open:** press down at the middle of the marking on lid ①.

► **To close:** fold down cover ①.

- ① Depending on the equipment installed, your vehicle is equipped with an ashtray or a stowage compartment.

Stowage compartment under the armrest

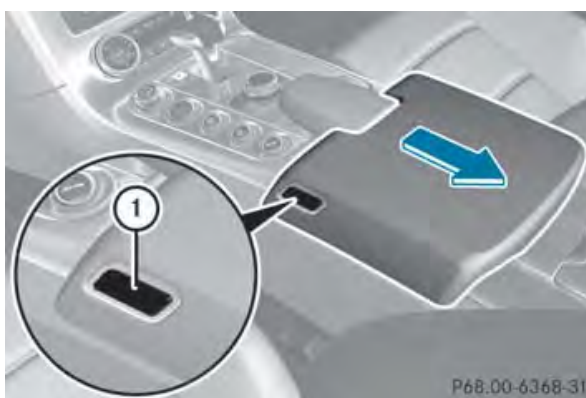

► **To open:** press button ① on the left or right and slide the armrest in the direction of the arrow.

The armrest engages in two different detents.

- ① **Roadster:** the stowage compartment can be locked and unlocked centrally using the SmartKey (▷ page 62).

Stowage compartment in the rear center console

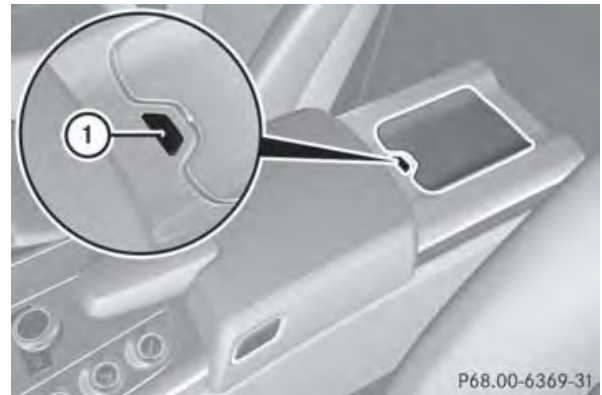

► Press button ①.

The stowage compartment opens.

- ① In the stowage compartment, you will find the ignition lock (▷ page 113) and the trunk lid emergency release (▷ page 73).

Stowage space on the rear wall between the seats

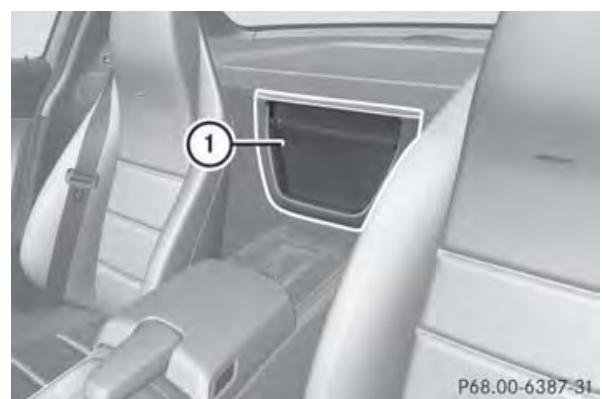

- ① Ruffled pocket

Parcel nets

There is a parcel net located in the front-passenger footwell.

Features

Cup holder

Important safety notes

WARNING

In order to help prevent spilling liquids on vehicle occupants and/or vehicle equipment, only use containers that fit into the cup holder. Use lids on open containers and do not fill containers to a height where the contents, especially hot liquids, could spill during braking, vehicle maneuvers, or in an accident. Liquids spilled on vehicle occupants may cause serious personal injury. Liquids spilled on vehicle equipment may cause damage not covered by the Mercedes-Benz Limited Warranty.

When not in use, keep the cup holder closed. An open cup holder may cause injury to you or others when contacted during braking, vehicle maneuvers, or in an accident.

Keep in mind that objects placed in the cup holder may come loose during braking, vehicle maneuvers, or in an accident and be thrown around in the vehicle interior. Objects thrown around in the vehicle interior may cause an accident and/or serious personal injury.

Cup holder in the center console



Example: Coupe

- Open the armrest (► page 197).
Cup holders ① are under the armrest.

Sun visors

Overview of sun visors

WARNING

Do not use the vanity mirror while driving. Keep the vanity mirrors in the sun visors closed while the vehicle is in motion. Reflected glare can endanger you and others.

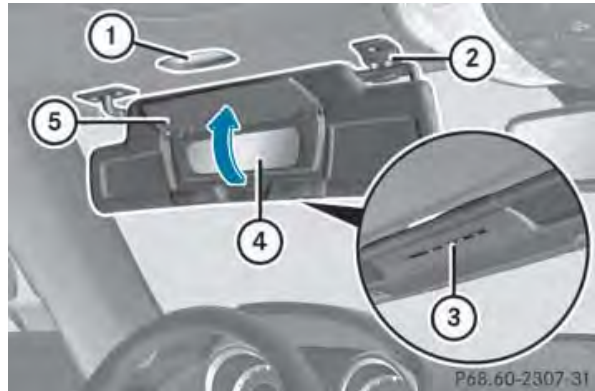

Example: Coupe

- ① Mirror light
- ② Bracket
- ③ Retaining strip, e.g. for a parking lot ticket
- ④ Vanity mirror
- ⑤ Mirror cover

Vanity mirror in the sun visor

Mirror light ① only functions if the sun visor is clipped into bracket ② and mirror cover ⑤ has been folded up.

Glare from the side

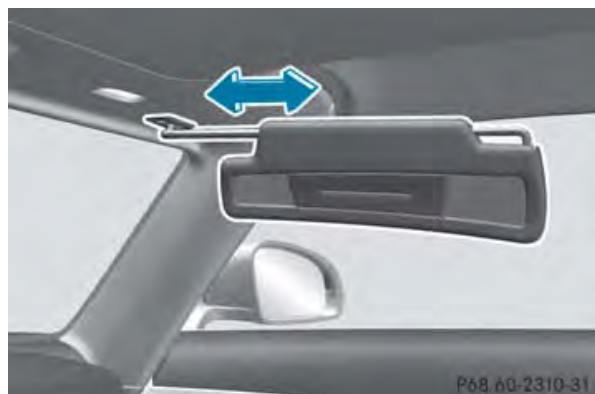

Example: Coupe

- ▶ Fold down the sun visor.
- ▶ Pull the sun visor out of bracket ②.
- ▶ Swing the sun visor to the side.
- ▶ Slide the sun visor horizontally as desired.

Ashtray

i You can remove the ashtray insert and use the resulting compartment for stowage.

! The stowage space under the ashtray is not heat resistant. Before placing lit cigarettes in the ashtray, make sure that the ashtray is properly engaged. Otherwise, the stowage space could be damaged.

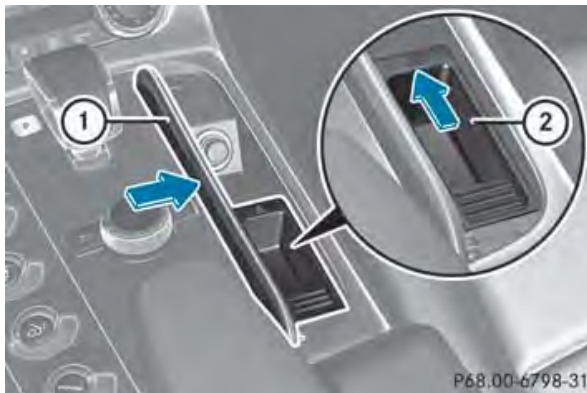

Example: Coupe

- ▶ **To open:** briefly press the middle of cover ①.
The stowage compartment opens.
- ▶ **To remove the insert:** slide insert ② forwards in the direction of the arrow.
- ▶ Remove insert ②.
- ▶ **To re-install the insert:** place insert ② into the holder and press it in the opposite direction of the arrow until it engages.
- ▶ **To close:** fold down cover ①.

Cigarette lighter

! WARNING

When leaving the vehicle, always remove the SmartKey from the ignition lock. Always take the SmartKey with you and lock the vehicle. Do not leave children unattended in the vehicle, even if they are secured in a child restraint system, or with access to an unlocked vehicle. A child's unsupervised access to a vehicle could result in an accident and/or serious personal injury. The children could:

- injure themselves on parts of the vehicle
- be seriously or fatally injured through excessive exposure to extreme heat or cold
- injure themselves or cause an accident with vehicle equipment that can be operated even if the SmartKey is removed from the ignition lock or removed from the vehicle, such as seat adjustment, steering wheel adjustment, or the memory function

If children open a door, they could injure other persons or get out of the vehicle and injure themselves or be injured by following traffic.

Do not expose the child restraint system to direct sunlight. The child restraint system's metal parts, for example, could become very hot, and the child could be burned on these parts.

! WARNING

Never touch the heating element or sides of the lighter; they are extremely hot. Hold the knob only.

Make sure any children traveling with you do not injure themselves or start a fire with the hot cigarette lighter.

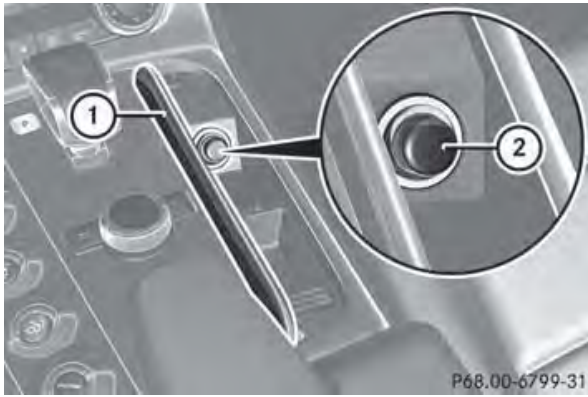

Example: Coupe

- ▶ Select key position **2** with the Start/Stop button.
- ▶ **To open:** briefly press the middle of cover **1**.
The stowage compartment opens.
- ▶ Press in cigarette lighter **2**.
Cigarette lighter **2** will pop out automatically when the heating element is red-hot.
- ▶ **To close:** fold down cover **1**.

12 V sockets

Points to observe before use

- ▶ Turn the SmartKey to position **1** in the ignition lock (▷ page 113).

The sockets can be used for accessories with a maximum current draw of 180 W (15 A), e.g. lamps or chargers for mobile phones.

If you use the sockets for long periods when the engine is switched off, the battery may discharge.

- i** You can also use the sockets when the ignition is switched off. An emergency cut-out ensures that the on-board voltage does not drop too low. If the on-board voltage is too low, the power to the sockets is automatically cut. This ensures that there is sufficient power to start the engine.

Socket in the glove box

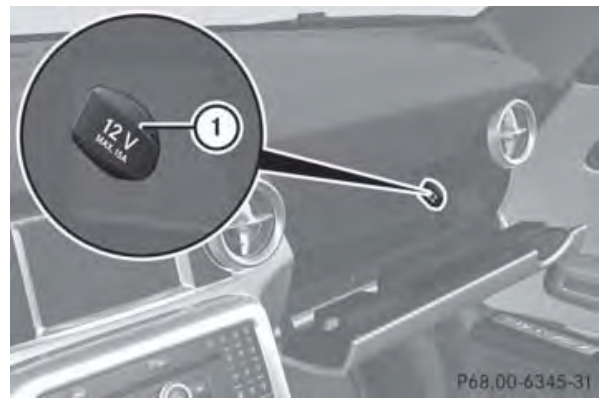

- ▶ Open the glove box (▷ page 196).
Lift up the cover of socket **1**.

Socket on the center console

- !** If accessories are connected, make sure that a maximum current draw of 15 A is not exceeded. Otherwise, you will overload the fuse.

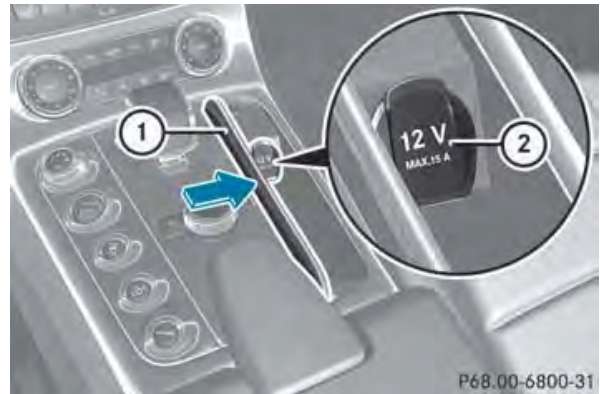

Example: Coupe

- ▶ **To open:** briefly press the middle of cover **1**.
The stowage compartment opens.
- ▶ Lift up the cover of socket **2**.
- ▶ **To close:** fold down cover **1**.

mbrace⁷

Important safety notes

! You must have a license agreement to activate the mbrace service. Ensure that your system is activated and ready for use, and press the  MB Info call button to register. If one of these steps is not carried out, it may not be possible to activate the system.

If you have questions about the activation, contact one of the following telephone hotlines:

- **USA:** Mercedes-Benz Customer Assistance center at 1-800-FOR-MERcedes (1-800-367-6372) or 1-866-990-9007
- **Canada:** Customer Service at 1-888-923-8367

Shortly after successfully registering with the mbrace service, a user ID and password will be sent to you by mail. You can use this password to log onto the mbrace area under "Owners Online" at <http://www.mbusa.com>⁸.

The mbrace system is available if:



- it has been activated and is operational
 - the corresponding mobile phone network is available for transmitting data to the Customer Center
 - a service subscription is available
 - the starter battery is sufficiently charged
- i** Determining the location of the vehicle on a map is only possible if there is sufficient GPS reception and the vehicle position can be forwarded to the Customer Center.

The mbrace system

The mbrace system provides various services, e.g.:

- automatic and manual emergency call
- Roadside Assistance call
- MB Info call

To adjust the volume during an mbrace call, proceed as follows:

▶ Press the  or  button on the multifunction steering wheel.

or





▶ Use the volume controller of COMAND.

You can find further information and a description of all available features under "Owners Online" at <http://www.mbusa.com>⁹.

Self-diagnosis of the system

After you have switched on the ignition, the system carries out a self-diagnosis.

A malfunction in the system has been detected if one of the following conditions occurs:

- the indicator lamp in the SOS button does not light up during the system self-diagnosis.
- the indicator lamp in the  Roadside Assistance button does not light up during the system self-diagnosis.
- the indicator lamp in the  information button does not light up during self-diagnosis of the system.
- the indicator lamp in the SOS button, the  Roadside Assistance button or the  information button continues to light up red after the system self-diagnosis.
- the **Tele Aid Inoperative** or **Tele Aid Not Activated** message appears in the multifunction display after the system self-diagnosis.

⁷ The system is called TELE AID in Canada.

⁸ USA only.

⁹ USA only.

If a malfunction is indicated as outlined above, the system may not operate as expected. In the event of an emergency, help will have to be summoned by other means.

Have the system checked at the nearest authorized Mercedes-Benz Center or contact the following service hotlines:

- **USA:** Mercedes-Benz Customer Assistance Center at 1-800-FOR-MERcedes (1-800-367-6372) or 1-866-990-9007
- **Canada:** Customer Service at 1-888-923-8367

Emergency call

Important safety notes

! You must have a license agreement to activate the mbrace service. Ensure that your system is activated and ready for use, and press the  MB Info call button to register. If one of these steps is not carried out, it may not be possible to activate the system.

If you have questions about the activation, contact one of the following telephone hotlines:

- **USA:** Mercedes-Benz Customer Assistance center at 1-800-FOR-MERcedes (1-800-367-6372) or 1-866-990-9007
- **Canada:** Customer Service at 1-888-923-8367

An emergency call is dialed automatically if an air bag or Emergency Tensioning Device is triggered.

i An mbrace emergency call that has been initiated automatically cannot be terminated by the customer.

An emergency call can also be initiated manually.

As soon as the emergency call has been initiated, the indicator lamp in the SOS button flashes. The **Connecting Call** message appears in the multifunction display.

The audio output is muted.

Once the connection has been made, the **Call Connected** message appears in the multifunction display.

All important information on the emergency is transmitted, for example:

- Current location of the vehicle (as determined by the GPS system)
- Vehicle identification number
- Information on the type of emergency

Shortly after the emergency call has been initiated, a voice connection is automatically established between the Mercedes-Benz Customer Assistance Center and the vehicle occupants. If the vehicle occupants respond, the Mercedes-Benz Customer Assistance Center attempts to get more information on the emergency.

i If there is no response from the vehicle occupants, an ambulance is immediately sent to the vehicle.

WARNING

If the indicator lamp in the SOS button is flashing continuously and there was no voice connection to the Response Center established, then the mbrace system could not initiate an emergency call (e.g. the relevant cellular phone network is not available).

The message **Call Failed** appears in the multifunction display for approximately 10 seconds.

Should this occur, assistance must be summoned by other means.

Making an emergency call



- ▶ **To initiate an emergency call manually:** press cover ① briefly to open.
- ▶ Press SOS button ② briefly. The indicator lamp in SOS button ② flashes until the emergency call is concluded.
- ▶ Wait for a voice connection to the Mercedes-Benz Customer Assistance Center.
- ▶ After the emergency call, close cover ①.

WARNING

If you feel at any way in jeopardy when in the vehicle (e.g. smoke or fire in the vehicle, vehicle in a dangerous road location), please do not wait for voice contact after you have pressed the SOS button. Carefully leave the vehicle and move to a safe location. The Response Center will automatically contact local emergency officials with the vehicle's approximate location if they receive an automatic SOS signal and cannot make voice contact with the vehicle occupants.

Roadside Assistance button



- ▶ Press and hold Roadside Assistance button ① for more than two seconds. This initiates a call to the Mercedes-Benz Customer Assistance Center. The indicator lamp in Roadside Assistance button ① flashes while the call is active. The **Connecting Call** message appears in the multifunction display. The audio output is muted.

If a connection can be made, the **Call Connected** message appears in the multifunction display.

If a cellular phone network is available and there is sufficient GPS reception, the mbrace system transmits data to the Mercedes-Benz Customer Assistance Center, for example:

- current location of the vehicle
- vehicle identification number

i The COMAND display shows that an mbrace call is active. During the call, you can change to the navigation menu by pressing the NAVI button on COMAND, for example.

Voice output is not available.

A voice connection is established between the Mercedes-Benz Customer Assistance Center and the vehicle occupants.

- ▶ Describe the type of assistance needed.

The Mercedes-Benz Customer Assistance Center either sends a qualified Mercedes-Benz technician or organizes for your vehicle to be transported to the nearest authorized

Mercedes-Benz Center. You may be charged for services such as repair work and/or towing. Further details are available in your mbrace manual.

i The mbrace system failed to initiate a Roadside Assistance call if:

- the indicator lamp in Roadside Assistance button ① is flashing continuously.
- no voice connection to the Mercedes-Benz Customer Assistance Center was established.

This may be because the corresponding mobile phone network is not available.

The **Call Failed** message appears on the multifunction display.

► **To end a call:** press the  button on the multifunction steering wheel.

or

► Press the corresponding button for ending a phone call on COMAND.

MB Info call button



► Press and hold MB Info call button ① for more than two seconds. This initiates a call to the Mercedes-Benz Customer Assistance Center. The indicator lamp in MB Info call button ① flashes while the connection is being established. The **Connecting Call** message appears in the multifunction display and COMAND is muted.

If a connection can be made, the **Call Connected** message appears in the multifunction display.

If a cellular phone network is available and there is sufficient GPS reception, the mbrace system transmits data to the Mercedes-Benz Customer Assistance Center, for example:

- current location of the vehicle
- vehicle identification number

i The COMAND display shows that an mbrace call is active. During the call, you can change to the navigation menu by pressing the NAVI button on COMAND, for example.

Voice output is not available.

A voice connection is established between the Mercedes-Benz Customer Assistance Center and the vehicle occupants. You can obtain information on how to operate your vehicle's systems, on the location of the nearest authorized Mercedes-Benz Center, and on further products and services offered by Mercedes-Benz USA.

Further details on the mbrace system can be found under <http://www.mbusa.com>¹⁰. Log in under "Owners Online".

i The mbrace system failed to initiate an MB Info call if:

- the indicator lamp in MB Info call button ① is flashing continuously.
- no voice connection to the Mercedes-Benz Customer Assistance Center was established.

This may be because the corresponding mobile phone network is not available.

The **Call Failed** message appears on the multifunction display.

► **To end a call:** press the  button on the multifunction steering wheel.

or

► Press the corresponding button for ending a phone call on COMAND.

¹⁰ USA only.

Call priority

When service calls are active, e.g. Roadside Assistance or MB Info calls, an emergency call can still be initiated. In this case, an emergency call will take priority and override all other active calls.

The indicator lamp of the respective button flashes until the call is ended. An emergency call can only be terminated by the Mercedes-Benz Customer Assistance Center. All other calls can be ended by pressing the  button on the multifunction steering wheel or the corresponding button for ending a telephone call on COMAND.

- i** If an mbrace call is initiated, audio output is muted. The mobile phone is no longer connected to COMAND. However, if you want to use your mobile phone, we recommend that you do this only when the vehicle is stationary and in a safe location.

Downloading destinations in COMAND

- i** Information on the components and operating principles of COMAND can be found in the separate COMAND operating instructions.

This service is part of the mbrace PLUS Package and cannot be purchased separately.

- i** You can only use the Destination Download function if the vehicle is equipped with a navigation system.

Destination Download gives you access to a database with over 15 million points of interest (POIs)/important destinations that can be downloaded onto the navigation system of your vehicle. If you know the destination, you can download the address or obtain the location of points of interest (POIs)/important destinations in the surrounding area.

You are prompted to confirm route guidance to the address entered.

The system calculates the route and subsequently starts the route guidance with the address entered.

- i** If you select **No**, the address can be stored in the address book.
- i** The Destination Download function is available if the corresponding mobile phone network is available and data transfer is possible.

Route Assistance

This service is part of the mbrace PLUS Package and cannot be purchased separately.

- i** You can also use the Route Assistance function if your vehicle is not equipped with a navigation system.

Within the framework of this service, you receive a professional and reliable form of navigation support without having to leave your vehicle.

The customer service representative determines a suitable driving route based on your current vehicle position and the desired destination and guides you live through the current sections of the route.

Search & Send

"Search & Send" is a destination entry service. You can find further information on "Search & Send" in the separate COMAND operating instructions.

Vehicle remote closing

If you forget to lock your vehicle but are no longer in the vicinity of the vehicle, it can be locked for you by the Mercedes-Benz Customer Assistance Center.

The vehicle can be locked remotely up to four days after the ignition was last switched off.

- Contact the following service hotlines:
 - **USA:** Mercedes-Benz Customer Assistance Center at

1-800-FOR-MERCEdes (1-800-367-6372)
or 1-866-990-9007

- **Canada:** Customer Service at
1-888-923-8367

You will be asked for your PIN.

The next time you are inside the vehicle and you switch on the ignition, the **Tele Aid Doors Locked Remotely** message appears in the multifunction display.

Alternatively, the vehicle can also be locked via the Internet or an iPhone in the "Owners Online" section using your ID number and password.

- i** The vehicle remote closing feature is available when the relevant mobile phone network is available and data connection is possible.

Stolen vehicle recovery service

If your vehicle has been stolen:

- ▶ Notify the police.
The police will issue a numbered incident report.
- ▶ This number will be forwarded to the Mercedes-Benz Customer Assistance Center together with your PIN.
The Mercedes-Benz Customer Assistance Center then attempts to locate the mbrace system. The Mercedes-Benz Customer Assistance Center contacts you and the local law enforcement agency if the vehicle is located. However, only the law enforcement agency is informed of the location of the vehicle.
- i** If the anti-theft alarm system is active for longer than 30 seconds, mbrace automatically informs the Mercedes-Benz Customer Assistance Center.

Rear spoiler

The rear spoiler improves the handling of the vehicle. It adapts the vehicle's aerodynamics

to the operating conditions, dependent on the speed of the vehicle.

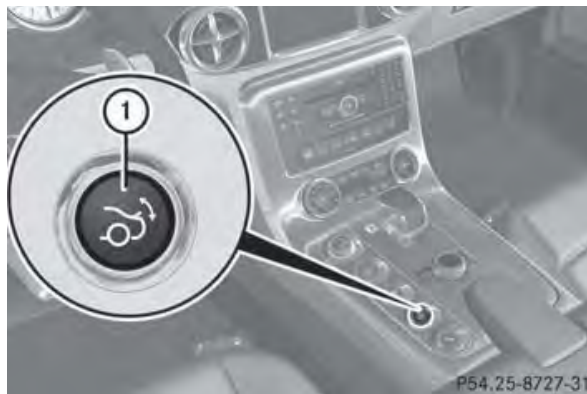

Example: Coupe

- i** If the vehicle is equipped with AMG adaptive sport suspension system, the button is in the switch strip above the air conditioning control panel.

Only use button ① to extend and retract the rear spoiler manually for cleaning. Button ① is not used to operate the rear spoiler.

If you drive at speeds above 75 mph (120 km/h), the rear spoiler extends automatically. Button ① flashes until the rear spoiler has extended and then lights up in red.

If you drive at speeds above 50 mph (80 km/h), the rear spoiler remains extended. Button ① remains lit in red.

If you drive at speeds below 50 mph (80 km/h), the rear spoiler retracts automatically. Button ① flashes until the rear spoiler has retracted and then goes out.

Extending and retracting the rear spoiler manually

You can extend and retract the rear spoiler manually for cleaning.

⚠ WARNING

During manual retraction of the rear spoiler, make sure that nobody becomes trapped. If there is a danger of someone becoming trapped, release the rear spoiler button to

pause retraction. The rear spoiler is then extended again.

Never leave children unsupervised in the vehicle. They could unintentionally retract the extended rear spoiler. Someone could then become trapped and seriously injured.

! Do not enter an automatic car wash with the rear spoiler extended. Otherwise, the rear spoiler may be damaged.

Only extend the rear spoiler in order to clean it by hand. Retract it again when you have finished cleaning it.

- ▶ Close the trunk lid.
- ▶ Select key position **2** with the Start/Stop button.
- ▶ **To extend:** press button ①.
The rear spoiler is extended.
Button ① flashes until the rear spoiler has extended and then lights up in red.
- ▶ **To retract:** press and hold button ① until the rear spoiler is completely retracted.
Button ① flashes until the rear spoiler has retracted and then goes out.

Rear Spoiler retracts manually
appears in the display.

- i** If you release button ① while retracting the rear spoiler, it extends again automatically.

Problems with the rear spoiler

Problem	Possible causes/consequences and ► Solutions
The rear spoiler stops before reaching the end position when retracting manually.	You have opened the trunk lid while manually retracting the rear spoiler. ► Close the trunk lid. The rear spoiler extends or, if you press and hold button ①, continues retracting.
The rear spoiler stops before reaching the end position when retracting/extending manually.	You have switched off the ignition. ► Switch the ignition back on. ► Press button ① to extend/retract the rear spoiler. The rear spoiler extends/retracts.
The rear spoiler cannot be retracted again after manually extending it.	You have opened the trunk lid while manually extending the rear spoiler. ► Close the trunk lid.
The rear spoiler does not extend or retract automatically.	The rear spoiler's movement is blocked, e.g. by an object jammed between the body and the rear spoiler. ► Remove the object.

Garage door opener

Important safety notes

The HomeLink® garage door opener integrated in the rear-view mirror allows you to operate up to three different door and gate systems.

i Certain garage door drives are incompatible with the integrated garage door opener. If you have difficulty programming the integrated garage door opener, contact an authorized Mercedes-Benz Center.

Alternatively, you can call the following telephone assistance services:

- **USA:** Mercedes-Benz Customer Assistance Center at 1-800-FOR-MERCEdes
- **Canada:** Customer Service at 1-800-387-0100

WARNING

Before programming the integrated remote control to a garage door opener or gate operator, make sure people and objects are out of the way of the device to prevent potential harm or damage. When programming a garage door opener, the door moves up or down. When programming a gate operator, the gate opens or closes.

Do not use the integrated remote control with any garage door opener that lacks safety stop and reverse features as required by U.S. federal safety standards (this includes any garage door opener model manufactured before April 1, 1982). A garage door that cannot detect an object - signaling the door to stop and reverse - does not meet current U.S. federal safety standards.

When programming a garage door opener, park vehicle outside the garage.

Do not run the engine while programming the integrated remote control. Inhalation of exhaust gas is hazardous to your health. All exhaust gas contains carbon monoxide (CO), and inhaling it can cause unconsciousness and possible death. All exhaust gas contains carbon monoxide (CO), and inhaling it can cause unconsciousness and possible death.

- i** Notes about the declaration of conformity can be found here (▷ page 21).

Programming the integrated garage door opener on the rear-view mirror

Programming buttons

WARNING

Only press the button on the integrated garage door opener if there are no persons or objects present within the sweep of the garage door. Persons could otherwise be injured as the door moves.

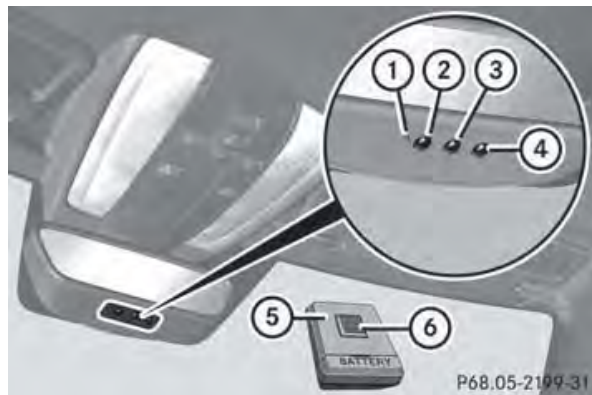

Integrated garage door opener in the rear-view mirror

Garage door remote control (5) is not part of the integrated garage door opener.

- ▶ The first time before programming, clear the integrated garage door opener memory (▷ page 211).
- ▶ Select key position **2** with the Start/Stop button.

- ▶ Press and hold one of buttons (2) to (4) on the integrated garage door opener. After a short time, indicator lamp (1) starts flashing yellow.

- i** Indicator lamp (1) lights up yellow as soon as button (2), (3) or (4) is programmed for the first time. If the selected button has already been programmed, indicator lamp (1) will only light up yellow after ten seconds have elapsed.

- ▶ Release button (2), (3) or (4). Indicator lamp (1) flashes yellow.

- ▶ Point garage door remote control (5) towards buttons (2) to (4) on the rear-view mirror at a distance of 2 to 8 inches (5 to 20 cm).

- i** The required distance between remote control (5) and the integrated garage door opener depends on the garage door drive system. Several attempts might be necessary. You should test every position for at least 25 seconds before trying another position.

- ▶ Press and hold button (6) on remote control (5) until indicator lamp (1) lights up green. If indicator lamp (1) lights up green or flashes, then programming has been successful.

- ▶ Release button (6) on remote control (5) for the garage door drive system.

- ▶ If indicator lamp (1) lights up red: repeat the programming procedure for the corresponding button on the rear-view mirror. When doing so, vary the distance between remote control (5) and the rear-view mirror.

- i** If the indicator lamp flashes green after successful programming, the garage door system is using a rolling code. After programming, you must synchronize the garage door opener integrated in the rear-view mirror with the receiver of the garage door system.

Synchronizing the rolling code

Your vehicle must be within reach of the garage door or exterior gate drive. Make sure that neither your vehicle nor any persons/objects are present within the sweep of the door or gate.

Observe the safety notes when performing the rolling code synchronization (▷ page 208).

- ▶ Select key position **2** with the Start/Stop button.
- ▶ Press the programming button of the door or gate drive (see the door or gate drive operating instructions, e.g. under "Programming of additional remote controls").
- i** Usually, you now have 30seconds to initiate the next step.
- ▶ Press previously programmed button **②**, **③** or **④** of the integrated garage door opener until the door starts to move. The rolling code synchronization is then complete.

Notes on programming the remote control

Canadian radio frequency laws require a "break" (or interruption) of the transmission signals after broadcasting for a few seconds. Therefore, these signals may not last long enough for the integrated garage door opener. The signal is not recognized during programming. Comparable with Canadian law, some U.S. garage door openers also feature a "break".

Proceed as follows:

- if you live in Canada
- if you have difficulties programming the garage door opener (regardless of where you live) when using the programming steps

- ▶ Press and hold one of buttons **②** to **④** on the integrated garage door opener. After a short time, indicator lamp **①** lights up yellow.
- ▶ Release the button. Indicator lamp **①** flashes yellow.
- ▶ Press button **⑥** of garage door remote control **⑤** for two seconds, then release it for two seconds.
- ▶ Press button **⑥** again for two seconds.
- ▶ Repeat this sequence on button **⑥** of remote control **⑤** until indicator lamp **①** lights up green. If indicator lamp **①** turns red, repeat the process.
- ▶ Continue with the other programming steps (see above).

Problems when programming

If you are experiencing problems programming the integrated garage door opener on the rear-view mirror, take note of the following instructions:

- Check the transmitter frequency of garage door drive remote control **⑤**. This can usually be found on the back of the remote control. The integrated garage door opener is compatible with devices that have units which operate in the frequency range of 280to 433MHz.
- Replace the batteries in garage door remote control **⑤**. This increases the likelihood that garage door remote control **⑤** will transmit a strong and precise signal to the integrated garage door opener in the rear-view mirror.
- When programming, hold remote control **⑤** at varying distances and angles from the button that you are programming. Try various angles at a distance between 2and 12 inches (5to 30 cm) or at the same angle but at varying distances.
- If another remote control for the same garage door drive is available, repeat the

same programming steps with this remote control. Before performing these steps, make sure that new batteries have been installed in garage door drive remote control ⑤.

- Note that some remote controls only transmit for a limited amount of time (the indicator lamp on the remote control goes out). Press button ⑥ on remote control ⑤ again before transmission ends.
- Align the antenna cable of the garage door opener unit. This can improve signal reception/transmission.

Opening/closing the garage door

Once programmed, the integrated garage door opener ⑤ will assume the function of the garage door system's remote control. Please also read the operating instructions for the garage door system.

- ▶ Select key position **2** with the Start/Stop button.
- ▶ Press button ②, ③ or ④ which you have programmed to operate the garage door. Garage door system with a fixed code: indicator lamp ① lights up green.

Garage door system with a rolling code: indicator lamp ① flashes green.

- ① The transmitter will transmit a signal as long as the button is pressed. The transmission is halted after a maximum of ten seconds and indicator lamp ① lights up yellow. Press button ②, ③ or ④ again if necessary.

Clearing the memory of the integrated garage door opener on the rear-view mirror

- ▶ Select key position **2** with the Start/Stop button.
- ▶ Press buttons ② and ④.
The indicator lamp lights up yellow.
- ▶ Press and hold buttons ② and ④ until the indicator lamp turns green.

- ① Make sure that you clear the memory of the integrated garage door opener before selling the vehicle.

Charge maintenance socket

The battery may drain if the vehicle is left stationary for long periods. In this case, Mercedes-Benz recommends attaching the trickle charger to the charge maintenance socket.

The charge maintenance socket is designed solely for connecting a trickle charger. A trickle charger can be obtained from an authorized Mercedes-Benz Center, for example.

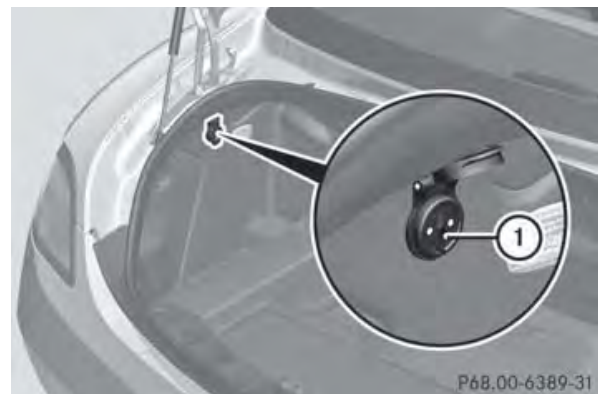

- ▶ Switch the ignition off.
- ▶ Open the trunk lid.
- ▶ Connect the cable provided in the trunk to the trickle charger.
- ▶ Connect the trickle charger to charge maintenance socket ①. Consult the manufacturer's operating instructions on how to do so.

- ① A trickle charger connected to charge maintenance socket ① only maintains the current charge level of the vehicle's electrical system battery. If the vehicle's electrical system battery is discharged, it needs to be charged with a battery charger. You will find further information on charging the battery on (▶ page 236).

Floormat on the driver's side

WARNING

Whenever you are using a floormat, make sure there is enough clearance and that the floormat is securely fastened.

The floormat should always be securely fastened using the fastening equipment.

Before driving off, check that the floormat is securely in place and adjust it if necessary. A loose floormat could slip and hinder proper functioning of the pedals.

Do not place several floormats on top of each other as this may impair pedal movement.

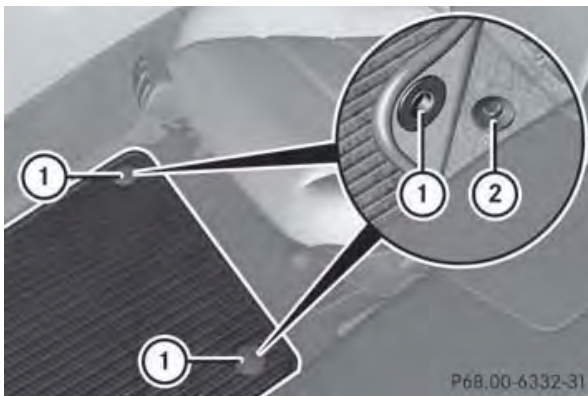

- ▶ Slide the seat backwards.
- ▶ **To install:** place the floormat in position.
- ▶ Press studs ① onto retainers ②.
- ▶ **To remove:** pull the floormat off retainers ②.
- ▶ Remove the floormat.

Useful information	214
Engine compartment	214
Maintenance	217
Care	219

Useful information

- i** This Operator's Manual describes all models and all standard and optional equipment of your vehicle available at the time of publication of the Operator's Manual. Country-specific differences are possible. Please note that your vehicle may not be equipped with all features described. This also applies to safety-related systems and functions.
- i** Please read the information on qualified specialist workshops (▷ page 22).

Engine compartment

Hood

Important safety notes

WARNING

If the hood is unlatched, it may open up when the vehicle is in motion and block your view. There is a risk of an accident.

Never unlatch the hood while driving.

WARNING

If the hood is unlatched, it could tip forward during rapid deceleration of the vehicle and hit persons or objects within its path. There is a risk of an accident and injury.

Therefore, always make sure that the hood is closed and locked completely before driving off.

WARNING

When opening and closing the hood, it may suddenly fall into the closed position. There is a risk of injury to persons within range of movement of the hood.

Open and close the hood only when no one is within its range of movement.

WARNING

Certain components in the engine compartment, such as the engine, radiator

and parts of the exhaust system, can become very hot. Working in the engine compartment poses a risk of injury.

Where possible, let the engine cool down and touch only the components described in the following.

WARNING

Opening the hood when the engine is overheated or when there is a fire in the engine compartment could expose you to hot gases or other service products. There is a risk of injury.

Let an overheated engine cool down before opening the hood. If there is a fire in the engine compartment, keep the hood closed and contact the fire department.

WARNING

The engine compartment contains moving components. Certain components, such as the radiator fan, may continue to run or start again suddenly when the ignition is off. There is a risk of injury.

If you need to do any work inside the engine compartment,

- switch off the ignition
- never reach into the area where there is a risk of danger from moving components, such as the fan rotation area
- keep clothing away from moving parts

Opening the hood

WARNING

The windshield wipers and wiper linkage could be set in motion.

When the hood is open, you or others could be injured by the wiper linkage.

Make sure that the windshield wipers are switched off. When using KEYLESS-GO, make sure that no ignition position is selected. All indicator lamps in the instrument cluster must be off.



Hood release lever in driver's footwell

- ▶ Pull release lever ① on the hood. The hood is released.

! Make sure that the windshield wipers are not folded away from the windshield. You could otherwise damage the windshield wipers or the hood.

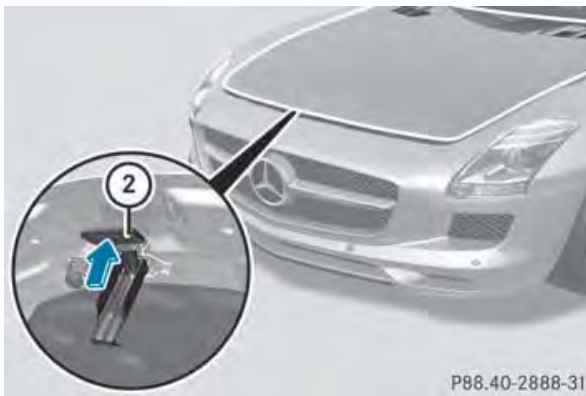

- ▶ Reach into the gap, pull hood catch handle ② up and lift the hood.

Closing the hood

- ▶ Lower the hood and let it fall from a height of approximately 8 inches (20 cm).
- ▶ Check that the hood has engaged properly. If the hood can be raised slightly, it is not properly engaged. Open it again and close it with a little more force.

Engine oil

General notes

Depending on the driving style, the vehicle consumes up to 0.9 US qt (0.8 l) of oil over a distance of 600 miles (1000 km). The oil consumption may be higher than this when the vehicle is new or if you frequently drive at high engine speeds.

Depending on the engine, the oil dipstick may be in a different location.

When checking the oil level:

- park the vehicle on a level surface.
- the engine should be switched off for approximately five minutes if the engine is at normal operating temperature.
- if the engine is not at normal operating temperature, e.g. if the engine was only started briefly, wait about 30 minutes before carrying out the measurement.

Checking the oil level using the oil dipstick

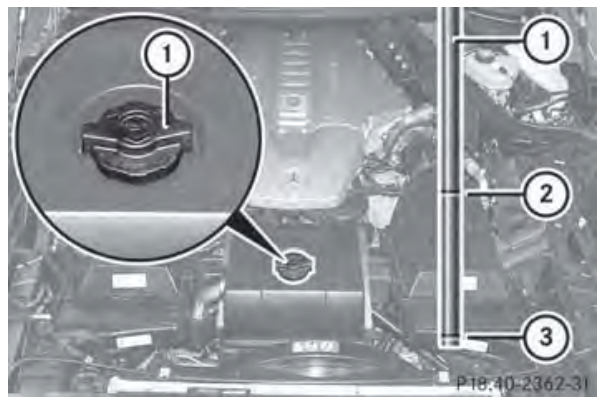

- ▶ Unscrew and remove oil filler cap ① with the integrated dipstick.
- ▶ Wipe the oil dipstick.
- ▶ Screw on oil filler cap ① again to the stop.

- ▶ Unscrew oil filler cap ① again and read the dipstick.
If the level is between MIN mark ③ and MAX mark ②, the oil level is correct.
- ▶ If the oil level has dropped to MIN mark ③ or below, add 1.1 US qt (1.0 liter) of engine oil.

Adding engine oil

WARNING

If engine oil comes into contact with hot components in the engine compartment, it may ignite. There is a risk of fire and injury. Make sure that engine oil is not spilled next to the filler neck. Let the engine cool down and thoroughly clean the engine oil off the components before starting the engine.

Environmental note

When adding oil, take care not to spill any. If oil enters the soil or waterways, it is harmful to the environment.

- ❗ Only use engine oils and oil filters that have been approved for vehicles with a service system. You can obtain a list of the engine oils and oil filters tested and approved in accordance with the Mercedes-Benz Specifications for Service Products at any Mercedes-Benz Service center.

Damage to the engine or exhaust system is caused by the following:

- using engine oils and oil filters that have not been specifically approved for the service system
- replacing engine oil and oil filters after the interval for replacement specified by the service system has been exceeded
- using engine oil additives.

- ❗ Do not add too much oil. adding too much engine oil can result in damage to the engine or to the catalytic converter. Have excess engine oil siphoned off.

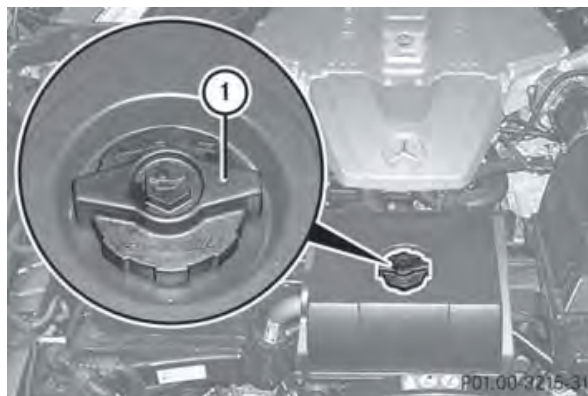

- ▶ Unscrew and remove oil filler cap ① with the integrated dipstick.
- ▶ Add engine oil.
If the oil level is at or under the MIN mark on the oil dipstick, add 1.1 US qt (1.0 liter) of engine oil.
- ▶ Replace cap ① on the filler neck and tighten clockwise.
Ensure that the cap locks into place securely.
- ▶ Check the oil level again with the oil dipstick (▷ page 215).

You will find further information about engine oil in the "Technical data" section (▷ page 279).

Checking and adding other service products

Checking coolant level

WARNING

The engine cooling system is pressurized, particularly when the engine is warm. When opening the cap, you could be scalded by hot coolant spraying out. There is a risk of injury. Let the engine cool down before opening the cap. Wear eye and hand protection when opening the cap. Open the cap slowly half a turn to allow pressure to escape.

Only check the coolant level when the vehicle is on a level surface and the engine has cooled down.

- ▶ Set the Start/Stop button to key position 2.
- ▶ Check the coolant temperature display in the "AMG" menu (▷ page 157).
The coolant temperature must be below 158 °F (70 °C).

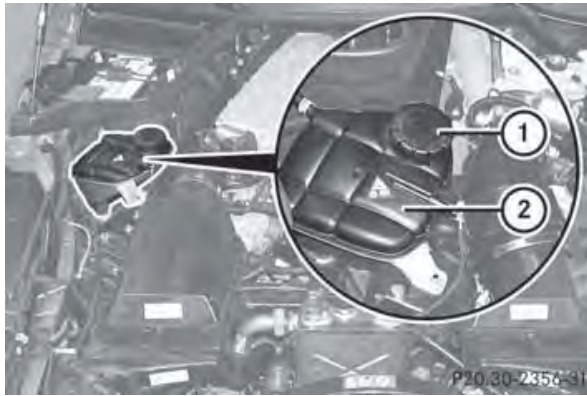

- ▶ Slowly turn cap ① half a turn counter-clockwise and allow excess pressure to escape.
- ▶ Turn cap ① further counter-clockwise and remove it.
If the coolant is at the level of the marker bar in the filler neck when cold, there is enough coolant in coolant expansion tank ②.
If the coolant level is approximately 0.6 in (1.5 cm) above the marker bar in the filler neck when warm, there is enough coolant in coolant expansion tank ②.
- ▶ If necessary, add coolant that has been tested and approved by Mercedes-Benz.
- ▶ Replace cap ① and turn it clockwise as far as it will go.

You will find further information about coolant in the "Technical data" section (▷ page 280).

Windshield washer system and headlamp cleaning system

WARNING

If antifreeze comes into contact with hot components in the engine compartment, it may ignite. There is a risk of fire and injury.

Let the engine cool down before you add antifreeze. Make sure that antifreeze is not spilled next to the filler neck. Thoroughly clean the antifreeze from components before starting the engine.

WARNING

Windshield washer concentrate is highly flammable. If it comes into contact with hot engine components or the exhaust system it could ignite. There is a risk of fire and injury. Make sure that no windshield washer concentrate is spilled next to the filler neck.

The washer fluid reservoir is used for both the windshield washer system and the headlamp cleaning system.

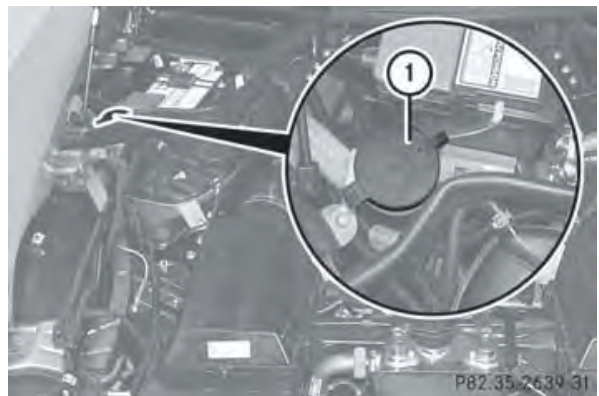

- ▶ **To open:** pull cap ① upwards by the tab.
- ▶ Add the premixed washer fluid.
- ▶ **To close:** press cap ① onto the filler neck until it engages.

Further information on windshield washer fluid/antifreeze (▷ page 281).

Maintenance

Service interval display

Service messages

Information on the type of service and service intervals (see the separate Maintenance Booklet).

You can obtain further information from an authorized Mercedes-Benz Center or at <http://www.mbusa.com> (USA only).

The service interval message informs you of the next service due date.

If a service due date has been exceeded, you also hear a warning tone.

The multifunction display shows a service message for several seconds, e.g.:

Next Service A in .. days

Service A Due

Service A Exceeded by .. days

The letter indicates which service is due. **A** stands for a minor service and **B** for a major service. A number or another letter may be displayed after the letter. This figure indicates any necessary additional maintenance work to be performed.

You can obtain further information from an authorized Mercedes-Benz Center.

The service interval display does not take into account any periods of time during which the battery is disconnected.

Maintaining the time-dependent service schedule:



- ▶ Note down the service due date displayed in the multifunction display before disconnecting the battery.

or





- ▶ After reconnecting the battery, subtract the battery disconnection periods from the service date shown on the display.

i The service interval display does not provide any information regarding the engine's oil level. Observe the notes on the engine oil level (▷ page 215).

Hiding a service message

- ▶ Press the  or  button on the steering wheel.

Displaying service messages

- ▶ Switch on the ignition.
- ▶ Press the  or  button on the steering wheel to select the **Serv.** menu.
- ▶ Press the  or  button to select the **ASSYST PLUS** submenu and confirm with .

The service due date appears in the multifunction display.

Points to remember

Resetting the service interval display

A qualified specialist workshop, e.g. an authorized Mercedes-Benz Center, will reset the service interval display after the necessary service work has been carried out. You can also obtain further information on maintenance work, for example.

- !** If the service interval display has been reset unintentionally, have the setting corrected at a Mercedes-Benz Center. Have service work carried out as described in the Maintenance Booklet. This may otherwise lead to increased wear and damage to the major assemblies or the vehicle.

Special service requirements

The specified maintenance interval takes only the normal operation of the vehicle into account. Under arduous operating conditions or increased load on the vehicle, maintenance work must be carried out more frequently, for example:

- regular city driving with frequent intermediate stops
- if the vehicle is primarily used to travel short distances
- use in mountainous terrain or on poor road surfaces
- if the engine is often left idling for long periods

Under these or similar conditions, have, for example, the air filter, engine oil and oil filter replaced or changed more frequently. Under arduous operating conditions, the tires must be checked more often. Further information can be obtained at a qualified specialist workshop, e.g. an authorized Mercedes-Benz Center.

Driving abroad

An extensive Mercedes-Benz Service network is also available in other countries. You can obtain further information from any authorized Mercedes-Benz Center.

Care

Notes on care

Regular care of your vehicle is a condition for retaining the quality in the long term.

Use care products and cleaning agents recommended and approved by Mercedes-Benz.

WARNING

Many cleaning products can be hazardous. Some are poisonous, others are flammable. Always follow the instructions on the particular container. Always open your vehicle's doors or windows when cleaning the inside.

Never use fluids or solvents that are not designed for cleaning your vehicle.

Always lock away cleaning products and keep them out of reach of children.

! For cleaning your vehicle, do not use any of the following:

- dry, rough or hard cloths
- abrasive cleaning agents
- solvents
- cleaning agents containing solvents

Do not scrub.

Do not touch the surfaces or protective films with hard objects, e.g. a ring or ice

scraper. You could otherwise scratch or damage the surfaces and protective film.

Environmental note

Dispose of empty packaging and cleaning cloths in an environmentally responsible manner.

! Do not park the vehicle for an extended period right after cleaning it, particularly after having cleaned the wheels with wheel cleaner. Wheel cleaners could cause increased corrosion of the brake discs and brake pads/linings. For this reason, you should drive for a few minutes after cleaning. Braking heats the brake discs and brake pads, thus drying them. The vehicle can then be parked.

Exterior care

Automatic car wash

WARNING

Braking efficiency is reduced after washing the vehicle. There is a risk of an accident.

After the vehicle has been washed, brake carefully while paying attention to the traffic conditions until full braking power is restored.

You can wash the vehicle in an automatic car wash from the very start.

If the vehicle is very dirty, pre-wash it before cleaning it in an automatic car wash.

! Never clean your vehicle in a Touchless Automatic Car Wash as these use special cleaning agents. These cleaning agents can damage the paintwork or plastic parts.

! When washing your vehicle in a tow-through car wash, use the SmartKey instead of the Start/Stop button.

Start the engine using the SmartKey.. Move the transmission to **N** with the E-SELECT lever. Use the SmartKey to switch the engine off again and then turn the SmartKey to position **2**. Make sure that you

then leave the SmartKey in position **2**. You may otherwise damage the vehicle, the transmission or the car wash.

Check the transmission position in the instrument cluster.

- ❗ Use the E-SELECT lever to shift the transmission to **N** before switching the engine off. If you open the driver's or front-passenger door, the transmission remains in this position for up to 30 minutes if the SmartKey is in the ignition, even if the engine is switched off. If you do not shift the transmission to **N** using the E-SELECT lever beforehand, it shifts automatically to parking position **P** and locks the wheels if the driver's or front-passenger door is opened and the engine is switched off. This may damage the vehicle, the transmission or the car wash.

Observe the information on maneuvering (▷ page 127).

- ❗ Before driving into an automatic car wash, make sure that it is suitable for the dimensions of the vehicle. In particular, make sure that:

- there is enough ground clearance between the vehicle underbody and the guide rails of the automatic car wash.
- the clearance width of the automatic car wash is sufficient, particularly the width of the guide rails.
- you enter the automatic car wash straight and in the center of the guide rails in order to avoid damaging the tires or wheel rims.

Fold in the exterior mirrors before the vehicle is washed. The exterior mirrors could otherwise be damaged.

- ❗ Make sure that:

- the side windows are fully closed.
- the ventilation/heating is switched off (the OFF button has been pressed/the airflow control is set to position **0**).
- that the windshield wiper switch is in position **0**.

Otherwise, the vehicle might be damaged.

- ❗ In portal car washes, the windshield wipers may be moved up the windshield by the cleaning brushes when the ignition is switched off.

Set the Start/Stop button to key position **2** to reset the windshield wipers to their original position.

- ❗ Preferably use automatic car washes with adjustable high-pressure pre-cleaning. This corresponds with the specification for the Cabriolet program. In car washes that use high water pressures, there is a risk that a small amount of water may leak into the vehicle.

- ❗ **Cabriolet:** do not treat the vehicle with hot wax under any circumstances.

After using an automatic car wash, wipe off wax and drying agents from the windshield and the wiper blades. This will prevent smears and reduce wiping noises caused by residue on the windshield.

Washing by hand

In some countries, washing by hand is only allowed at specially equipped washing bays. Observe the legal requirements in each country.

- ▶ Do not use hot water and do not wash the vehicle in direct sunlight.
- ▶ Use a soft sponge to clean.
- ▶ Use a mild cleaning agent, such as a car shampoo approved by Mercedes-Benz.
- ▶ Thoroughly hose down the vehicle with a gentle jet of water.
- ▶ Do not point the water jet directly towards the air inlet.

- ▶ Use plenty of water and rinse out the sponge frequently.
- ▶ Rinse the vehicle with clean water and dry thoroughly with a chamois.
- ▶ Do not let the cleaning agent dry on the paintwork.

Carefully remove all deposits of road salt as soon as possible when driving in winter.

Power washers

WARNING

The water jet from a circular jet nozzle (dirt blasters) can cause invisible exterior damage to the tires or chassis components.

Components damaged in this way may fail unexpectedly. There is a risk of an accident.

Do not use power washers with circular jet nozzles to clean the vehicle. Have damaged tires or chassis components replaced immediately.

- ❗ Maintain a minimum distance of 11.8 in (30 cm) between the vehicle and the power washer nozzle. Information about the correct distance is available from the equipment manufacturer.

Move the power washer nozzle around when cleaning your vehicle.

Do not aim directly at any of the following:

- tires
- door gaps, roof gaps, joints, etc.
- electrical components
- battery
- connectors
- lights
- seals
- trim elements
- ventilation slots

Damaged seals or electrical components can lead to leaks or failures.

Cleaning the wheels

- ❗ Do not use acidic wheel cleaning products to remove brake dust. This could damage wheel bolts and brake components.

- ❗ Do not park the vehicle for an extended period right after cleaning it, particularly after having cleaned the wheels with wheel cleaner. Wheel cleaners could cause increased corrosion of the brake discs and brake pads/linings. For this reason, you should drive for a few minutes after cleaning. Braking heats the brake discs and brake pads, thus drying them. The vehicle can then be parked.

Cleaning the paintwork

Scratches, corrosive deposits, areas affected by corrosion and damage caused by inadequate care cannot always be completely repaired. In such cases, visit a qualified specialist workshop, e.g. an authorized Mercedes-Benz Center.

- ▶ Remove impurities immediately, where possible, whilst avoiding rubbing too hard.
- ▶ Soak insect remains with insect remover and rinse off the treated areas afterwards.
- ▶ Soak bird droppings with water and rinse off the treated areas afterwards.
- ▶ Remove coolant, brake fluid, tree resin, oils, fuels and greases by rubbing gently with a cloth soaked in petroleum ether or lighter fluid.
- ▶ Use tar remover to remove tar stains.
- ▶ Use silicone remover to remove wax.

- ❗ Do not affix:

- stickers
- films
- magnetic plates or similar items

to painted surfaces. You could otherwise damage the paintwork.

If water no longer forms "beads" on the paint surface, use the paint care products recommended and approved by Mercedes-

Benz. This is the case approximately every three to five months, depending on the climate conditions and the care product used. If dirt has penetrated the paint surface or the paint has become dull, the paint cleaner recommended and approved by Mercedes-Benz should be used.

Do not use these care products in the sun or on the hood while the hood is hot.

- ▶ Use a suitable touch-up stick, e.g. MB Touch-Up Stick, to correct smaller areas of paint damage quickly and provisionally.

Matte finish care

If your vehicle has a clear matte finish, observe the following instructions in order to avoid damage to the paintwork due to incorrect care.

These notes also apply to light alloy wheels with a clear matte finish.

- ❗ Never polish the vehicle or the light alloy wheels. Polishing causes the finish to shine.

- ❗ The following may cause the paint to become shiny and thus reduce the matte effect:

- Vigorous rubbing with unsuitable materials.
- Frequent use of car washes.
- Washing the vehicle in direct sunlight.

- ❗ Never use paint cleaner, buffing or polishing products such as gloss preserver (wax). These products are only suitable for high-gloss surfaces. Their use on vehicles with matte finish leads to considerable surface damage (shiny, spotted areas).

If wax comes into contact with the painted surface by accident, remove it immediately with commercially available petroleum ether. Do so carefully and do not apply too much pressure to the painted surface.

Ensure that no resinous, greasy or oily substances come into contact with the

paint, as these can leave a residue. If such substances do come into contact with the painted surface accidentally, remove these immediately with commercially available petroleum ether. Do so carefully and do not apply too much pressure to the painted surface.

Tar stains or marks on the painted surface can be removed with a commercially available tar remover. Do so carefully and do not apply too much pressure to the painted surface.

Always have paintwork repairs carried out at a qualified specialist workshop, e.g. an authorized Mercedes-Benz Center.

- ❗ Do not use wash programs with a hot wax treatment under any circumstances.

- i The vehicle should preferably be washed by hand using a soft sponge, car shampoo and plenty of water.

- i Use only insect remover and car shampoo from the range of recommended and approved Mercedes-Benz care products.

Cleaning the Roadster soft top

- ▶ **Light soiling:** you can clean the soft top while it is dry or rinse it with clear water.
- ▶ **Normal to heavy soiling:** clean the soft top with a brush and clear water. Clean stains and other dirt with a brush and soft top cleaning agents that have been recommended and approved by Mercedes-Benz. Always brush from front to back, following the grain of the fabric.

- ❗ Never use any of the following to clean the soft top:

- gasoline
- thinner
- tar or stain remover
- other organic solvents

- ❗ Remove bird droppings immediately, as they are corrosive and can therefore cause the soft-top fabric to leak. Do not wash the

vehicle with a power washer or in a car wash that uses power washers. Do not use sharp-edged equipment to remove ice and snow.

Frequent cleaning reduces the soft top's resistance to dirt.

To restore this resistance to dirt, clean the soft top using soft top cleaning agents that have been recommended and approved by Mercedes-Benz.

Incorrect cleaning and care, as well as aging, can cause the soft-top seams to leak. Have the soft-top seams sealed at a qualified specialist workshop, e.g. at an authorized Mercedes-Benz Center.

- i** Cover the soft top appropriately if you plan to leave the vehicle outside for a long period of time.

Cleaning the windows

WARNING

You could become trapped by the windshield wipers if they start moving while cleaning the windshield or wiper blades. There is a risk of injury.

Always switch off the windscreen wipers and the ignition before cleaning the windshield or wiper blades.

- !** Only fold the windshield wipers away from the windshield when vertical. Otherwise, you will damage the hood.
- ▶ Clean the inside and outside of the windows with a damp cloth and a cleaning agent that is recommended and approved by Mercedes-Benz.
- !** Do not use dry cloths, abrasive products, solvents or cleaning agents containing solvents to clean the inside of the windows. Do not use hard objects to clean the insides of the windows, e.g. an ice scraper or ring. There is otherwise a risk of damaging the windows.
- !** Clean the water drainage channels of the windshield and the rear window at regular intervals. Deposits such as leaves, petals and pollen may under certain circumstances prevent water from draining away. This can lead to corrosion damage and damage to electronic components.

Cleaning wiper blades

WARNING

You could become trapped by the windshield wipers if they start moving while cleaning the windshield or wiper blades. There is a risk of injury.

Always switch off the windscreen wipers and the ignition before cleaning the windshield or wiper blades.

- !** Only fold the windshield wipers away from the windshield when vertical. Otherwise, you will damage the hood.
- !** Do not pull the wiper blade. Otherwise, the wiper blade could be damaged.
- !** Do not clean wiper blades too often and do not rub them too hard. Otherwise, the graphite coating could be damaged. This could cause wiper noise.
- ▶ Switch off the engine.
- ▶ Remove your foot from the brake pedal.
- ▶ Set the windshield wiper to the  position on the combination switch.
- ▶ Press the Start/Stop button repeatedly until the windshield wipers start.
- ▶ When the wiper arms have reached a vertical position, press the Start/Stop button.
- ▶ Fold the wiper arm away from the windshield until it engages.
- ▶ Set the wiper blade at right angles to the wiper arm.
- ▶ Carefully clean the wiper blades with a damp cloth.
- ▶ Fold the windshield wiper arms back again before switching on the ignition.

! Hold the wiper arm securely when folding back. The windshield could be damaged if the wiper arm smacks against it suddenly.

Cleaning the exterior lighting

► Clean the plastic lenses of the exterior lighting using a wet sponge and a mild cleaning agent, e.g. Mercedes-Benz car shampoo or cleaning cloths.

! Only use cleaning agents or cleaning cloths which are suitable for plastic light lenses. Unsuitable cleaning agents or cleaning cloths could scratch or damage the plastic light lenses.

Cleaning the mirror turn signals

! Only use cleaning agents or cleaning cloths that are suitable for plastic lenses. Unsuitable cleaning agents or cleaning cloths could scratch or damage the plastic lenses of the mirror turn signals.

► Clean the plastic lenses of the mirror turn signals in the exterior mirror housing using a wet sponge and a mild cleaning agent, e.g. Mercedes-Benz car shampoo or cleaning cloths.

Cleaning the sensors

! When cleaning the sensors with a power washer, maintain a distance between the vehicle and the nozzle of the power washer of at least 11.8 in (30 cm). Information about the correct distance is available from the equipment manufacturer.

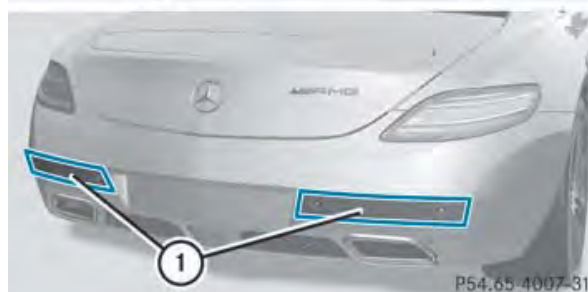

► Clean sensors ① of the driving systems with water, car shampoo and a soft cloth.

Cleaning the rear view camera



► Use clear water and a soft cloth to clean camera lens ①.

! Do not clean the camera lens and the area around the rear view camera with a power washer.

Cleaning the exhaust pipes

! Do not clean the exhaust pipe with acid-based cleaning agents such as sanitary cleansers or wheel cleaners.

► Clean the exhaust pipe with a chrome care product tested and approved by Mercedes-Benz.

Impurities combined with the effects of road grit and corrosive environmental factors may cause flash rust to form on the surface. You can restore the original shine of the exhaust pipe by cleaning it regularly, especially in winter and after washing.

Interior care

Cleaning the display

! For cleaning, do not use any of the following:

- alcohol-based thinner or gasoline
- abrasive cleaning agents
- commercially-available household cleaning agents

These may damage the display surface. Do not put pressure on the display surface when cleaning. This could lead to irreparable damage to the display.

- ▶ Before cleaning the display, make sure that it is switched off and has cooled down.
- ▶ Clean the display surface using a commercially available microfiber cloth and TFT/LCD display cleaner.
- ▶ Dry the display surface using a dry microfiber cloth.

Cleaning the plastic trim

WARNING

Care products and cleaning agents containing solvents cause surfaces in the cockpit to become porous. As a result, plastic parts may come loose in the event of air bag deployment. There is a risk of injury.

Do not use any care products and cleaning agents to clean the cockpit.

! Do not affix the following to plastic surfaces:

- stickers
- films
- scented oil bottles or similar items

You can otherwise damage the plastic.

! Do not allow cosmetics, insect repellent or sunscreen to come into contact with the plastic trim. This maintains the high-quality look of the surfaces.

▶ Wipe the plastic trim with a damp, lint-free cloth, e.g. a microfiber cloth.

▶ **Heavy soiling:** use car care and cleaning products recommended and approved by Mercedes-Benz.

The surface may change color temporarily. Wait until the surface is dry again.

Cleaning the steering wheel and selector lever

▶ Thoroughly wipe with a damp cloth or use leather care agents that have been recommended and approved by Mercedes-Benz.

Cleaning genuine wood and trim elements

! Do not use solvent-based cleaning agents such as tar remover, wheel cleaners, polishes or waxes. There is otherwise a risk of damaging the surface.

! Do not use chrome polish on trim pieces. The trim pieces have a chrome look but are mostly made of anodized aluminum and can lose their shine if chrome polish is used. Use a damp, lint-free cloth instead when cleaning the trim pieces.

If the chrome-plated trim pieces are very dirty, you can use a chrome polish. If you are unsure as to whether the trim pieces are chrome-plated or not, consult an authorized Mercedes-Benz Center.

▶ Wipe the wooden trim and trim pieces with a damp, lint-free cloth, e.g. a microfiber cloth.

▶ **Heavy soiling:** use car care and cleaning products recommended and approved by Mercedes-Benz.

Cleaning the seat covers

General notes

! Do not use microfiber cloths to clean genuine leather, artificial leather or Alcantara® covers. If used often, these can damage the cover.

i Note that regular care is essential to ensure that the appearance and comfort of the covers is retained over time.

Genuine leather seat covers

Leather is a natural product.

It exhibits natural surface characteristics, for example:

- Differences in the texture
- Signs of stretching and marking
- Slight nuances of color

These are characteristics of leather and not material defects.

! To retain the natural appearance of the leather, observe the following cleaning instructions:

- Clean genuine leather covers carefully with a damp cloth and then wipe the covers down with a dry cloth.
- Make sure that the leather does not become soaked. It may otherwise become rough and cracked.
- Only use leather care agents that have been tested and approved by Mercedes-Benz. You can obtain these from a qualified specialist workshop.

Seat covers of other materials

! Observe the following when cleaning:

- Clean artificial leather covers with a cloth moistened with a solution containing 1% detergent (e.g. dish washing liquid).
- Clean cloth covers with a microfiber cloth moistened with a solution containing 1% detergent (e.g. dish washing liquid). Rub carefully and always wipe entire seat sections to avoid leaving visible lines. Leave the seat to dry

afterwards. Cleaning results depend on the type of dirt and how long it has been there.

- Clean Alcantara® covers with a damp cloth. Make sure that you wipe entire seat sections to avoid leaving visible lines.

Cleaning the seat belts

WARNING

Seat belts can become severely weakened if bleached or dyed. This could cause the seat belts to tear or fail, for instance, in the event of an accident. This poses an increased risk of injury or fatal injury.

Never bleach or dye the seat belts.

! Do not clean the seat belts using chemical cleaning agents. Do not dry the seat belts by warming them above 176 °F (80 °C) or placing them in direct sunlight.

- ▶ Use clean, lukewarm water and soap solution.

Useful information	228
Where will I find...?	228
Flat tire	229
Battery	236
Jump-starting	240
Towing and tow-starting	242
Fuses	244

Useful information

- i** This Operator's Manual describes all models and all standard and optional equipment of your vehicle available at the time of publication of the Operator's Manual. Country-specific differences are possible. Please note that your vehicle may not be equipped with all features described. This also applies to safety-related systems and functions.
- i** Please read the information on qualified specialist workshops (▷ page 22).

Where will I find...?

First-aid kit

The first-aid kit is located in the left-hand stowage compartment in the trunk.

- ▶ Open the trunk lid.

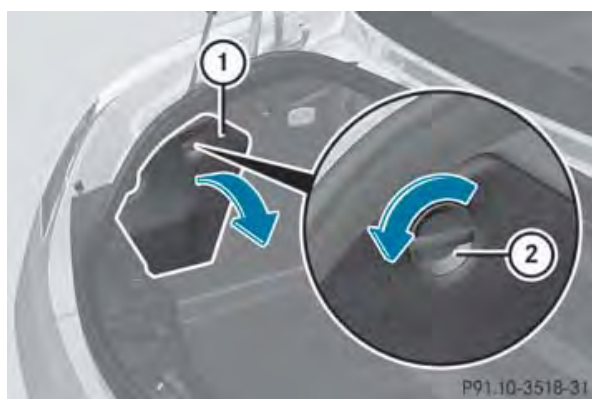

- ▶ Turn fastener ② in the direction of the arrow.
 - ▶ Open stowage compartment ①.
 - ▶ Open the Velcro fastener and remove the first aid kit.
- i** Check the expiration date on the first-aid kit at least once a year. Replace the contents if necessary, and replace missing contents.

Vehicle tool kit

Wheel-change tool kit and jack¹¹

The wheel-change tool kit and the jack are located in the left-hand stowage space in the trunk.

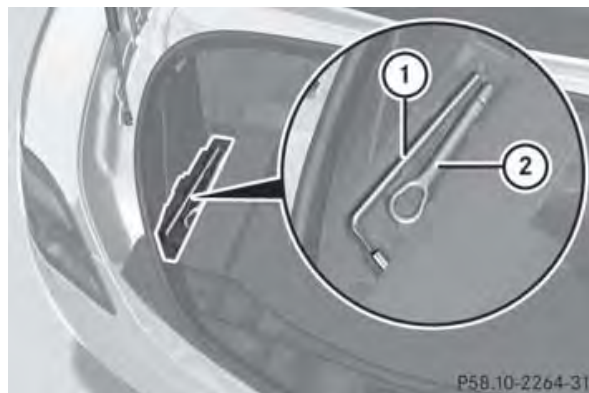

Left-hand stowage space in trunk floor

- ① Lug wrench
- ② Towing eye

- ▶ Pull the loop on the floor covering and fold the floor covering forward.
- ▶ Take out the jack and lug wrench ① underneath it.

TIREFIT kit, wheel chock, alignment bolt and gloves

The TIREFIT kit, wheel chock, alignment bolt and gloves are located in the left-hand stowage compartment in the trunk.

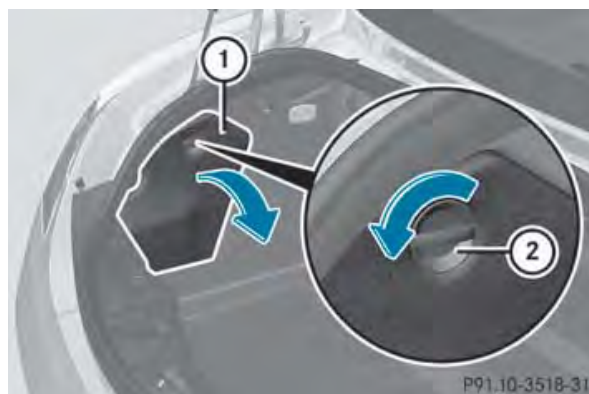

Left-hand stowage compartment in the trunk

¹¹ Not included in the scope of delivery in all countries.

- ▶ Remove the jack from the left-hand stowage space in the trunk to allow the stowage compartment to be opened.
- ▶ Turn fastener ② in the direction of the arrow.
- ▶ Open stowage compartment ①.
- ▶ Remove the TIREFIT kit, wheel chock, alignment bolt and gloves.

Flat tire

Preparing the vehicle

Your vehicle is equipped with a TIREFIT kit.

- ▶ Stop the vehicle on solid, non-slippery and level ground, as far away as possible from traffic.
- ▶ Switch on the hazard warning lamps.
- ▶ Apply the electric parking brake manually (▷ page 129).
- ▶ Bring the front wheels into the straight-ahead position.
- ▶ Shift the transmission to **P** with the button in the center console.
- ▶ Switch off the engine.
- ▶ Remove the SmartKey from the ignition lock.
- ▶ All occupants must get out of the vehicle. Make sure that they are not endangered as they do so.
- ▶ Make sure that no one is near the danger area while a wheel is being changed. Anyone who is not directly assisting in the wheel change should, for example, stand behind the barrier.
- ▶ Get out of the vehicle. Pay attention to traffic conditions when doing so.
- ▶ Close the driver's door.

TIREFIT kit

Using the TIREFIT kit

WARNING

TIREFIT is a limited repair device. TIREFIT cannot be used for cuts or punctures larger than approximately 0.16 in (4 mm) and tire damage caused by driving with extremely low tire inflation pressure, or on a flat tire, or a damaged wheel.

Do not drive the vehicle under such circumstances.

Contact the nearest authorized Mercedes-Benz Center for assistance or call Roadside Assistance.

WARNING

Take care not to allow the contents of TIREFIT to come in contact with hair, eyes or clothing. TIREFIT is harmful if inhaled, swallowed or absorbed through the skin - causes skin, eye and respiratory irritation.

Any contact with eyes or skin should be flushed immediately with plenty of water.

If clothing comes in contact with TIREFIT, change clothing as soon as possible.

In case of allergic reaction or rash, consult a physician immediately.

WARNING

Keep TIREFIT away from children. If swallowed, rinse mouth immediately with plenty of water and drink plenty of water.

Do not induce vomiting.

Consult a doctor immediately.

Keep away from open flame or heat source.

You can use the TIREFIT kit to seal small punctures, particularly those in the tire tread. You can use TIREFIT at outside temperatures down to -40 °C.

- ▶ Do not remove any foreign objects which have penetrated the tire, e.g. screws or nails.
- ▶ Take the TIREFIT kit out of the trunk (▷ page 228).



- ▶ Open the TIREFIT kit and remove "max. 80 km/h" sticker (8).
- ▶ Affix sticker (8) within the driver's field of vision.
- i** If TIREFIT leaks out, allow it to dry. It can then be removed like a layer of film. If you get TIREFIT on your clothing, have it cleaned as soon as possible with perchloroethylene.

Comply with the manufacturer's safety instructions on the tire inflation compressor label and on the tire sealant bottle.

- i** You will also find operating instructions (3) in the lid of the TIREFIT kit.
- ▶ Pull the cable and filler hose (9) out of the housing.



- ▶ Unscrew flanged cap (5).

- ▶ Unscrew the cap from tire sealant bottle (1). Make sure that the aluminum film is not damaged when doing so.

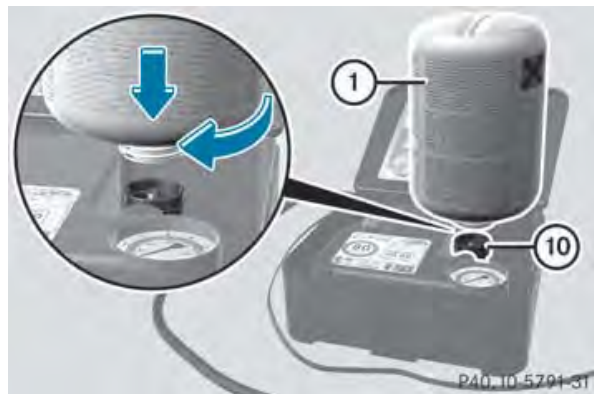

- ▶ Screw tire sealant bottle (1) clockwise tightly onto flange seal (10). This pierces the aluminum film.
- ▶ Remove the cap from the valve on the faulty tire.
- ▶ Make sure that pressure release screw (7) is closed.
- ▶ Remove the dust protection cap from filler hose (9).

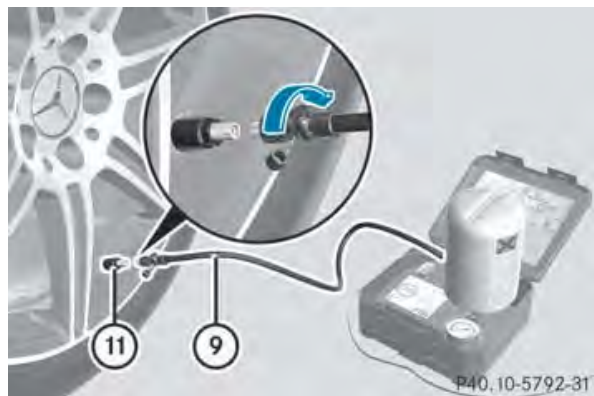

- ▶ Screw the end of filler hose (9) onto tire valve (11).
- ▶ Make sure that on/off switch (2) on the tire inflation compressor is set to 0.
- ▶ Insert connector (4) into the 12 V cigarette lighter socket (▷ page 199).
- ▶ Select key position 2 with the Start/Stop button (▷ page 113).
- i** The battery discharges during tire inflation compressor usage. For this

reason, you should start the engine unless you are inflating the tire in an enclosed space.

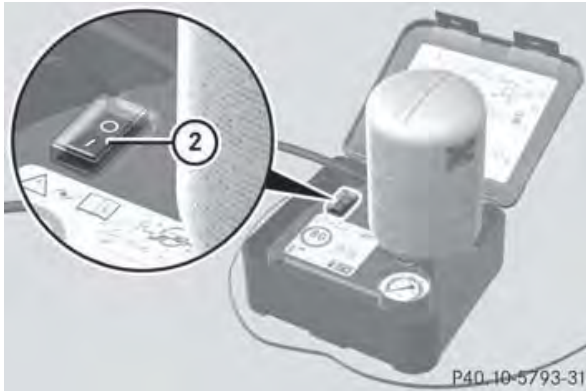

- ▶ Press on/off switch ② on the tire inflation compressor to **I**. The tire inflation compressor is switched on. The tire is inflated.

i First, TIREFIT is pumped into the tire. The pressure can briefly rise to approximately 500 kPa (5 bar/73 psi).

Do not switch off the tire inflation compressor during this phase.

- ▶ Let the tire inflation compressor run for a maximum of ten minutes. The tire should then have attained a pressure of at least 180 kPa (1.8 bar/26 psi). Switch the tire inflation compressor off briefly to read the correct value from pressure gauge ⑥.

! Do not operate the tire inflation compressor for longer than ten minutes at a time without a break. It may otherwise overheat.

The tire inflation compressor can be operated again once it has cooled down.

Tire pressure of at least 180 kPa (1.8 bar/26 psi) is not reached

⚠ WARNING

If after five minutes a pressure of 180 kPa (1.8 bar/26 psi) cannot be achieved, the tire is too badly damaged to be repaired reliably using TIREFIT.

In this case TIREFIT cannot seal the tire properly.

Do not drive any further.

Contact the nearest authorized Mercedes-Benz Center for assistance or call Roadside Assistance.

If, after five minutes, a pressure of 180 kPa (1.8 bar/26 psi) has not been achieved:

- ▶ Switch off the tire inflation compressor, remove it and drive the vehicle approximately 30 ft (10 m) forward or back. This distributes the TIREFIT more evenly.
- ▶ Leave tire sealant bottle ① attached to the flange.
- ▶ Pump up the tire again.

Tire pressure of 180 kPa (1.8 bar/26 psi) is reached

If the tire pressure is at least 180 kPa (1.8 bar/26 psi):

- ▶ Press on/off switch ② on the tire inflation compressor to **0**. The tire inflation compressor is switched off.
- ▶ Remove connector ④ from the 12 V socket.
- ▶ Remove filler hose ⑨ from tire valve ⑪ and re-install the dust protection cap. Screw the valve cap onto the valve again. Leave tire sealant bottle ① attached to flange ⑩.
- ▶ Stow the TIREFIT kit in a safe and accessible place in the vehicle.
- ▶ **Pull away immediately.**

! After use, excess TIREFIT may run out of the filler hose. This could cause stains.

⚠ WARNING

Do not exceed a vehicle speed of 50 mph (80 km/h). A TIREFIT repair is not designed to operate at higher speeds.

The sticker must be attached on the instrument cluster where it will be easily seen by the driver.

Vehicle handling characteristics of a TIREFIT repaired tire may change. Adapt your driving accordingly.

- ▶ Stop after driving for approximately ten minutes and check the tire pressure with the tire inflation compressor.

i On tires that are equipped with a tire pressure sensor (tire pressure monitor), the use of sealant can lead to malfunction messages and incorrect displays. Therefore, use pressure gauge **⑥** in the TIREFIT kit to check and correct the tire pressure.

WARNING

If tire inflation pressure has fallen below 130 kPa (1.3 bar/26 psi) do not continue to drive the vehicle.

Park your vehicle safely away from the roadway and contact the nearest authorized Mercedes-Benz Center or Roadside Assistance.

Have the damaged tire replaced.

- ▶ Correct the tire pressure if it is still at least 130 kPa (1.3 bar/20 psi) (for the values, see the Tire and Loading Information placard on the driver's side B-pillar or tire pressure table on the fuel filler flap).

To increase the tire pressure: switch on the tire inflation compressor.

To reduce the tire pressure: open release screw **⑦**.

! The manufacturer does not guarantee that all tire damage can be repaired using the TIREFIT kit, particularly in the case of cuts and punctures with a diameter of more than four millimeters or on the sidewall. The manufacturer is not responsible for damage caused by inappropriate use of the TIREFIT kit.

- ▶ Drive to the nearest workshop and have the tire changed there.

- ▶ Have the tire sealant bottle replaced as soon as possible at a qualified specialist workshop, e.g. at an authorized Mercedes-Benz Center.

Environmental note

Have the used tire sealant bottle disposed of professionally, e.g. at an authorized Mercedes-Benz Center.

- ▶ Have the TIREFIT kit replaced every four years at a qualified specialist workshop, e.g. an authorized Mercedes-Benz Center.

Changing a wheel and mounting the spare wheel

Preparing the vehicle

- ▶ Prepare the vehicle as described ([▷ page 229](#)).
- ▶ Bring the wheels into the straight-ahead position.
- ▶ Take the following objects from the left-hand stowage compartment and the left-hand stowage space in the trunk:
 - lug wrench
 - folding wheel chock
 - jack
 - alignment bolt
- ▶ Secure the vehicle to prevent it from rolling away.

Securing the vehicle to prevent it from rolling away

WARNING

Only jack up the vehicle on level ground or on slight inclines/declines. The vehicle could otherwise fall off the jack and injure you or others.

If your vehicle is equipped with a wheel chock, it can be found in the vehicle tool kit (▷ page 228).

The folding wheel chock is an additional securing measure to prevent the vehicle from rolling away, for example when changing a wheel.

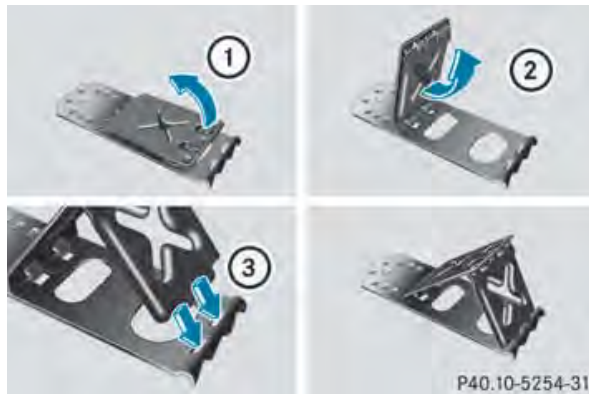

- ▶ Fold both plates upwards ①.
- ▶ Fold out lower plate ②.
- ▶ Guide the lugs on the lower plate fully into the openings in base plate ③.



Securing the vehicle on level ground

- ▶ **On level ground:** place chocks or other suitable items under the front and rear of the wheel that is diagonally opposite the wheel you wish to change.

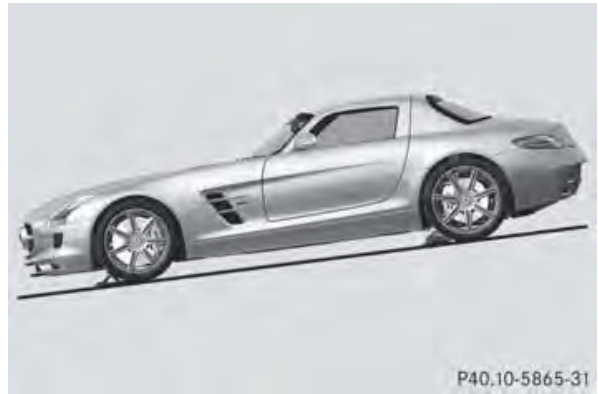

Securing the vehicle on slight downhill gradients

- ▶ **On downhill gradients:** place chocks or other suitable items in front of the wheels of the front and rear axle.

Raising the vehicle

WARNING

When jacking up the vehicle, only use the jack which has been specifically approved by Mercedes-Benz for your vehicle.

The jack is designed exclusively for jacking up the vehicle at the jacking points built into both sides of the vehicle. The jack saddle must be placed centrally under the jacking point. The jack must always be vertical when in use, especially on inclines or declines.

The jack is intended only for lifting the vehicle briefly for wheel changes. It is not suited for performing maintenance work under the vehicle. To help avoid personal injury, use the jack only to lift the vehicle during a wheel change.

Never get beneath the vehicle while it is supported by the jack. Keep hands and feet away from the area under the lifted vehicle. Always lower the vehicle onto sufficient capacity jackstands before working under the vehicle.

Always firmly engage the parking brake and block the wheels with wheel chocks or other sizable objects before raising the vehicle with the jack. Do not disengage the parking brake while the vehicle is raised.

Make sure that the ground on which the vehicle is standing and where you place the jack is solid, level and not slippery. If necessary, use a large underlay. On slippery surfaces, such as tiled floors, you should use a non-slip underlay, for example a rubber mat.

Do not use wooden blocks or similar objects as a jack underlay. Otherwise, the jack may not be able to achieve its load-bearing capacity if it is not at its full height.

Never start the engine when the vehicle is raised.

Also observe the notes on the jack.



- ▶ Using lug wrench ①, loosen the bolts on the wheel you wish to change by about one full turn. Do not unscrew the wheel bolts completely.

The mounting for the jack is centered between the front and rear wheel housings (arrow).

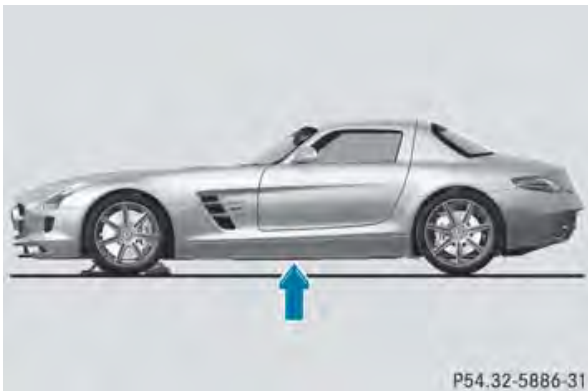

WARNING

The jack is designed exclusively for jacking up the vehicle at the jacking points. The jack

saddle must be placed centrally under the jacking point.

If you do not position the jack correctly in the jacking point, the vehicle can fall off the jack and seriously or fatally injure you or others.

- ❗ The jack is designed exclusively for jacking up the vehicle at the jacking points. Otherwise, your vehicle could be damaged.

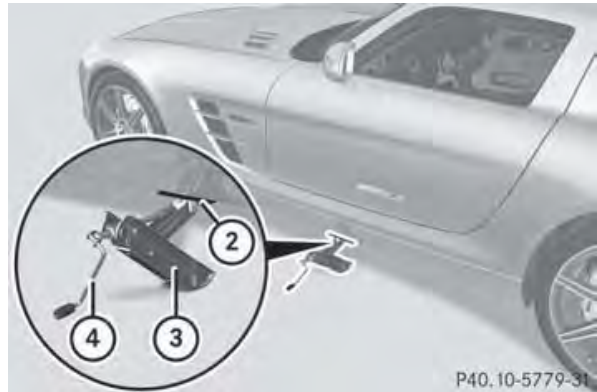

- ▶ Position jack ③ at jacking point ②.

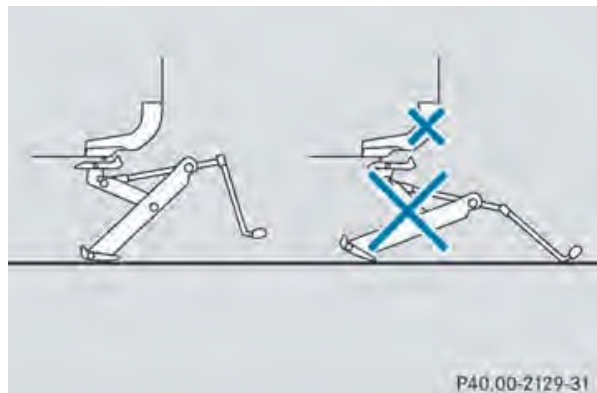

- ▶ Make sure that the base of the jack is positioned directly under jacking point ②.
- ▶ Turn crank ④ clockwise until jack ③ sits completely on jacking point ② and the base of the jack lies evenly on the ground.
- ▶ Turn crank ④ until the tire is raised a maximum of 1.2 inches (3 cm) off the ground.

Removing a wheel

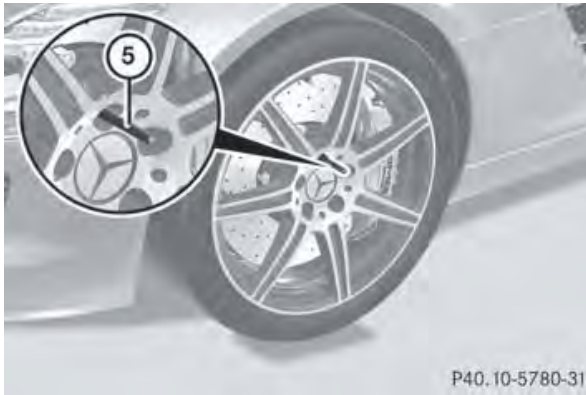

- ▶ Unscrew the uppermost wheel bolt completely.
- ▶ Screw alignment bolt ⑤ into the thread instead of the wheel bolt.
- ▶ Unscrew the remaining wheel bolts fully.

! Do not place wheel bolts in sand or on a dirty surface. The bolt and wheel hub threads could otherwise be damaged when you screw them in.

! AMG ceramic high performance compound brake system:
When detaching or attaching the wheel, the wheel rim may hit against the ceramic brake disc and damage it.
For this reason, you should proceed carefully. Request the assistance of a second person or use a second alignment bolt.

- ▶ Remove the wheel.

Mounting a new wheel

! WARNING

Always replace wheel bolts that are damaged or rusted.

Never apply oil or grease to wheel bolts. Damaged wheel hub threads should be repaired immediately. Do not continue to drive under these circumstances! Contact an authorized Mercedes-Benz Center or call Roadside Assistance.

Incorrect wheel bolts or improperly tightened wheel bolts can cause the wheel to come off. This could cause an accident. Make sure to use the correct wheel bolts.

! WARNING

Only use genuine Mercedes-Benz wheel bolts. Other wheel bolts may come loose.

Do not tighten the wheel bolts when the vehicle is raised. Otherwise, the vehicle could fall off the jack.



① Wheel bolt

! WARNING

Make sure to use the original length wheel bolts when remounting the original wheel after it has been repaired.

- ▶ Clean the wheel and wheel hub contact surfaces.

! To prevent damage to the paintwork, hold the wheel securely against the wheel hub while screwing in the first wheel bolt.



- ▶ Place the wheel onto the alignment bolt and push it on.



- ▶ Tighten the wheel bolts until they are finger-tight.
- ▶ Unscrew the alignment bolt.
- ▶ Tighten the last wheel bolt until it is finger-tight.

Lowering the vehicle

WARNING

The wheels could work loose if the wheel nuts and bolts are not tightened to the specified tightening torque. There is a risk of accident. Have the tightening torque immediately checked at a qualified specialist workshop after a wheel is changed.

- ▶ Turn the crank of the jack counter-clockwise until the vehicle is once again standing firmly on the ground.
- ▶ Place the jack to one side.



- ▶ Tighten the wheel bolts evenly in a crosswise pattern in the sequence

indicated (① to ⑤). The specified tightening torque is **133 lb-ft (180 Nm)**.

- ▶ Turn the jack back to the out-of-use position and stow it in the trunk again with the rest of the wheel-changing tools.

Battery

Important safety notes

Special tools and expert knowledge are required when working on the battery, e.g. removal and installing. You should therefore have all work involving the battery carried out at a qualified specialist workshop.

WARNING

Work carried out incorrectly on the battery can, for example, lead to a short circuit and damage your vehicle's electronic system. This can disrupt driving safety systems such as ABS (anti-lock braking system) or ESP[®] (Electronic Stability Program).

- If ABS malfunctions, the wheels can lock during braking. This limits the steerability of the vehicle when braking and the braking distance may increase. There is a risk of accident.
- If ESP[®] malfunctions, the vehicle will not be stabilized if it starts to skid or a wheel starts to spin. There is a risk of accident.

You should therefore have all work involving the battery carried out at a qualified specialist workshop.

WARNING

Electrostatic build-up can lead to the creation of sparks, which could ignite the highly explosive gases of a battery. There is a risk of an explosion.

Before handling the battery, touch the vehicle body to remove any existing electrostatic build-up.

The highly flammable gas mixture forms when charging the battery as well as when jump-starting.

Always make sure that neither you nor the battery is electrostatically charged. A build-up of electrostatic charge can be caused, for example:

- by wearing clothing made from synthetic fibers
- due to friction between clothing and seats
- if you push or pull the battery across the carpet or other synthetic materials
- if you wipe the battery with a cloth.

 **WARNING**

During the charging process, a battery produces hydrogen gas. If a short circuit occurs or sparks are created, the hydrogen gas can ignite. There is a risk of an explosion.

- Make sure that the positive terminal of a connected battery does not come into contact with vehicle parts.
- Never place metal objects or tools on a battery.
- It is important that you observe the described order of the battery terminals when connecting and disconnecting a battery.
- When jump-starting, make sure that the battery poles with identical polarity are connected.
- It is particularly important to observe the described order when connecting and disconnecting the jumper cables.
- Never connect or disconnect the battery terminals while the engine is running.

 **WARNING**

Battery acid is caustic. There is a risk of injury. Avoid contact with the skin, eyes or clothing. Do not inhale any battery gases. Do not lean over the battery. Keep children away from batteries. Wash battery acid immediately with water and seek medical attention.

 **Environmental note**



Batteries contain dangerous substances. It is against the law to dispose of them with the household rubbish. They must be collected separately and recycled to protect the environment.



Dispose of batteries in an environmentally friendly manner. Take discharged batteries to a qualified specialist workshop or a special collection point for used batteries.

 Have the battery checked regularly at a qualified specialist workshop.

Observe the service intervals in the Maintenance Booklet or contact a qualified specialist workshop for more information.

 You should have all work involving the battery carried out at a qualified specialist workshop. In the exceptional case that it is necessary for you to disconnect the battery yourself, make sure that:

- you switch off the engine and remove the SmartKey. On vehicles with KEYLESS-GO, ensure that the ignition is switched off. Check that all the indicator lamps in the instrument cluster are off. Otherwise, electronic components, such as the alternator, may be damaged.
- you first remove the negative terminal clamp and then the positive terminal clamp. Never swap the terminal clamps. Otherwise, the vehicle's electronic system may be damaged.
- the transmission is locked in position **P** after disconnecting the battery. The vehicle is secured against rolling away. You can then no longer move the vehicle.

The battery and the cover of the positive terminal clamp must be installed securely during operation.

Comply with safety precautions and take protective measures when handling batteries.



Risk of explosion.



Fire, open flames and smoking are prohibited when handling the battery. Avoid creating sparks.



Battery acid is caustic. Avoid contact with skin, eyes or clothing. Wear suitable protective clothing, especially gloves, apron and faceguard.

Rinse any acid spills immediately with clear water. Contact a physician if necessary.



Wear eye protection.



Keep children away.



Observe this Operator's Manual.

For safety reasons, Mercedes-Benz recommends that you only use batteries which have been tested and approved for your vehicle by Mercedes-Benz. These batteries provide increased impact protection to prevent vehicle occupants from suffering acid burns should the battery be damaged in the event of an accident.

In order for the battery to achieve the maximum possible service life, it must always be sufficiently charged.

The vehicle battery, like other batteries, can discharge over time if you do not use the vehicle. In this case, have the battery disconnected at a qualified specialist workshop. You can also charge the battery with a charger recommended by Mercedes-

Benz. Contact a qualified specialist workshop for further information.

Have the battery condition of charge checked more frequently if you use the vehicle mainly for short trips or if you leave it standing idle for a lengthy period. Consult a qualified specialist workshop if you wish to leave your vehicle parked for a long period of time.

- i** Remove the SmartKey if you park the vehicle and do not require any electrical consumers. The vehicle will then use very little energy, thus conserving battery power.
- i** If the battery power supply has been interrupted, e.g. if the battery was fully discharged, you will need to reset the "exterior mirrors automatic folding function", by folding the mirrors out once (▷ page 88).

Charging the battery

WARNING

During charging and jump-starting, explosive gases can escape from the battery. There is a risk of an explosion.

Particularly avoid fire, open flames, creating sparks and smoking. Ensure there is sufficient ventilation while charging and jump-starting. Do not lean over a battery.

WARNING

Battery acid is caustic. There is a risk of injury. Avoid contact with the skin, eyes or clothing. Do not inhale any battery gases. Do not lean over the battery. Keep children away from batteries. Wash battery acid immediately with water and seek medical attention.

WARNING

A discharged battery can freeze at temperatures below freezing point. When jump-starting the vehicle or charging the battery, gases can escape from the battery. There is a risk of an explosion.

Allow the frozen battery to thaw out before charging it or jump-starting.

! Only use battery chargers with a maximum charging voltage of 14.8 V.

! Only charge the battery using the jump-starting connection point.

The jump-starting connection point is in the engine compartment (▷ page 240).

Never charge the battery if it is still installed in the vehicle, unless you use a battery charger which has been tested and approved by Mercedes-Benz. A battery charger unit specially adapted for Mercedes-Benz vehicles and tested and approved by Mercedes-Benz is available as an accessory. It permits the charging of the battery in its installed position. Contact an authorized Mercedes-Benz Center for further information and availability. Charge the battery in accordance with the separate instructions for the accessory battery charger.

Read the battery charger's operating instructions before charging the battery.

- ▶ Open the hood (▷ page 214).
- ▶ Connect the battery charger to the positive terminal and ground point in the same order as when connecting the donor battery in the jump-starting procedure (▷ page 240).

Jump-starting

WARNING

Battery acid is caustic. There is a risk of injury.

Avoid contact with the skin, eyes or clothing. Do not inhale any battery gases. Do not lean over the battery. Keep children away from batteries. Wash battery acid immediately with water and seek medical attention.

WARNING

During charging and jump-starting, explosive gases can escape from the battery. There is a risk of an explosion.

Particularly avoid fire, open flames, creating sparks and smoking. Ensure there is sufficient ventilation while charging and jump-starting. Do not lean over a battery.

WARNING

During the charging process, a battery produces hydrogen gas. If a short circuit occurs or sparks are created, the hydrogen gas can ignite. There is a risk of an explosion.

- Make sure that the positive terminal of a connected battery does not come into contact with vehicle parts.
- Never place metal objects or tools on a battery.
- It is important that you observe the described order of the battery terminals when connecting and disconnecting a battery.
- When jump-starting, make sure that the battery poles with identical polarity are connected.
- It is particularly important to observe the described order when connecting and disconnecting the jumper cables.
- Never connect or disconnect the battery terminals while the engine is running.

WARNING

A discharged battery can freeze at temperatures below freezing point. When jump-starting the vehicle or charging the battery, gases can escape from the battery. There is a risk of an explosion. Allow the frozen battery to thaw out before charging it or jump-starting.

WARNING

Non-combusted fuel can collect in the exhaust system and ignite. There is a risk of fire. Avoid repeated and lengthy starting attempts.

! Avoid repeated and lengthy starting attempts. Otherwise, the catalytic converter could be damaged by the non-combusted fuel.

Do not start the vehicle using a rapid charging device. If your vehicle's battery is discharged, the engine can be jump-started from another vehicle or from a second battery using jumper cables. Observe the following points:

- The battery is not accessible in all vehicles. If the other vehicle's battery is not accessible, jump-start the vehicle using a second battery or a jump-starting device.
- You may only jump-start the vehicle when the engine and exhaust system are cold.

- Do not start the engine if the battery is frozen. Let the battery thaw first.
- Only jump-start from batteries with a 12 V voltage rating.
- Only use jumper cables which have a sufficient cross-section and insulated terminal clamps.
- If the battery is fully discharged, leave the battery that is being used to jump-start connected for a few minutes before attempting to start. This charges the battery slightly.
- Make sure that the two vehicles do not touch.

Make sure that:

- the jumper cables are not damaged.
 - when the jumper cables are connected to the battery, uninsulated sections of the terminal clamp do not come into contact with other metal sections.
 - the jumper cables cannot come into contact with parts such as the V-belt pulley or the fan. These parts move when the engine is started and while it is running.
- ▶ Press the electric parking brake handle.
- ▶ Shift the transmission to **P** with the button in the center console.
- ▶ Remove the SmartKey from the ignition lock.
- ▶ Switch off all electrical consumers (e.g. radio, blower, etc.).
- ▶ Open the hood (▷ page 214).

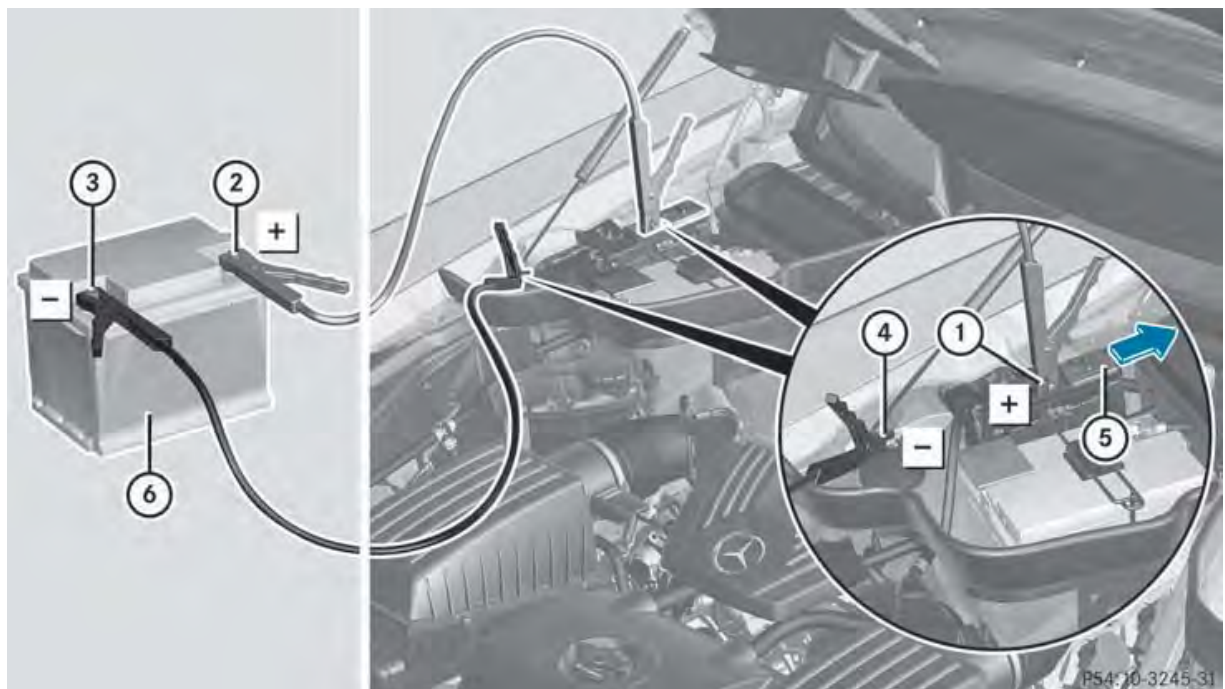

Position number ⑥ identifies the charged battery of the other vehicle or an equivalent jump-starting device.

- ▶ Slide cover ⑤ of positive terminal ① in the direction of the arrow.
- ▶ Connect positive terminal ① on your vehicle to positive terminal ② of donor battery ⑥ using the jumper cable, beginning with your own battery.
- ▶ Start the engine of the donor vehicle and run it at idling speed.

- ▶ Connect negative terminal ③ of donor battery ⑥ to earth point ④ of your vehicle using the jumper cable, connecting the jumper cable to donor battery ⑥ first.
- ▶ Start the engine.
- ▶ Before disconnecting the jumper cables, let the engine run for several minutes.
- ▶ First, remove the jumper cables from earth point ④ and negative terminal ③, then from positive clamp ① and positive terminal ②. Each time beginning with your vehicle's battery.
- ▶ Slide cover ⑤ of the positive terminal in the opposite direction to the arrow.
- ▶ Have the battery checked at a qualified specialist workshop.

i Jump-starting is not considered to be a normal operating condition.

i Jumper cables and further information regarding jump-starting can be obtained at any qualified specialist workshop.

Towing and tow-starting

Important safety notes

If the vehicle can no longer be driven because of an accident or breakdown, you have the following options:

- transporting the vehicle
As a rule, you should have the vehicle transported.
- towing the vehicle with the rear axle raised
Only tow the vehicle with the rear axle raised in exceptional cases.
- towing the vehicle with a tow rope or tow bar
Only tow the vehicle in exceptional cases. The engine must be running if you tow the vehicle with a tow rope or tow bar. Observe the following notes.

WARNING

The rear axle locks when:

- the engine is not running
- the engine stalls while the vehicle is being towed
- there is a malfunction in the power supply or the vehicle's electrical system

There is a risk of an accident.

In the event of a breakdown, you should always have the vehicle transported.

WARNING

If the brake system or power steering is malfunctioning and your vehicle is then towed away, significantly more effort may be required to steer and brake than is normally required. There is a risk of an accident.

In such cases, use a tow bar. Before towing, make sure that the steering moves freely.

- !** Use the SmartKey instead of the Start/ Stop button when towing the vehicle. Start the engine and keep it running. Turn the SmartKey to position **2** in the ignition. Set the transmission to **N** using the E-SELECT lever. Make sure that you then leave the SmartKey in position **2**. Check the transmission position in the instrument cluster.

- !** Make sure that the electric parking brake is released. If the electric parking brake is faulty, visit a qualified specialist workshop. Mercedes-Benz recommends that you use an authorized Mercedes-Benz Center for this purpose.

- !** When towing, pull away slowly and smoothly. If the tractive power is too high, the vehicles could be damaged.

- !** Only secure the tow rope or tow bar at the towing eyes. Otherwise, the vehicle could be damaged.

- ❗ Do not use the towing eye for recovery, as this could damage the vehicle. If in doubt, recover the vehicle with a crane.
- ❗ You may only tow the vehicle a maximum distance of 30 miles (50 km). A towing speed of 30 mph (50 km/h) must not be exceeded.
For towing distances over 30 miles (50 km), the vehicle must be loaded onto a transporter.
- ❗ Do not tow with sling-type equipment. This could damage the vehicle.
- ❗ Tow-starting the vehicle is not permitted. The transmission may otherwise be damaged.

Also observe the following notes:

- If the engine does not start, try jump-starting it (▷ page 240). Tow-starting the vehicle is not permitted.
- If it is not possible to jump-start the vehicle, have it transported to the nearest qualified specialist workshop, e.g. an authorized Mercedes-Benz Center.
- If the vehicle has transmission damage, have it transported to a qualified specialist workshop. Observe the display messages in the instrument cluster.

Installing/removing the towing eye

Installing the towing eye

- ▶ Take the towing eye and the wheel wrench¹² out of the wheel-change tool kit (▷ page 228).

The bracket for the removable towing eye is in the bumper at the front. It is located under the cover.



- ▶ Pull out cover ① forwards.
- ▶ Take cover ① off the opening.

Removing the towing eye

- ▶ Take the lug wrench¹² from the wheel-change tool kit (▷ page 228).
- ▶ Insert the lug wrench handle into the towing eye and turn it counter-clockwise.
- ▶ Unscrew the towing eye.
- ▶ Attach cover ① to the bumper and press until it engages.
- ▶ Return the towing eye and the lug wrench to the wheel-change tool kit.

Towing the vehicle with the rear axle raised

When towing your vehicle with the rear axle raised, it is important that you observe the safety instructions (▷ page 242).

Only tow the vehicle with the rear axle raised in exceptional cases.

- ❗ The engine must be switched off (SmartKey in ignition lock in position **0** or position **1**) if the vehicle is being towed with the rear axle raised or if the parking brake is being tested on a dynamometer. Intervention by ESP[®] could otherwise damage the brake system.

¹² Not included in the scope of delivery.

- ▶ Switch on the hazard warning lamps (▷ page 94).
- ▶ Make sure that the SmartKey is in position **2** in the ignition and that the engine is running throughout the towing procedure.
- ▶ Move the transmission to **N** with the E-SELECT lever. Check the transmission position in the instrument cluster.

Towing a vehicle with both axles on the ground

When having your vehicle towed, observe the important safety notes (▷ page 242).

- ▶ Switch on the hazard warning lamps (▷ page 94).
- i** When towing with the hazard warning lamps switched on, use the combination switch as usual to signal a change of direction. In this case, only the turn signals for the desired direction flash. When the combination switch is reset, the hazard warning lamps start flashing again.
- ▶ Insert the SmartKey into the ignition lock (▷ page 113).
- ▶ Start the engine and leave the SmartKey in the ignition.
- ▶ Move the transmission to **N** with the E-SELECT lever.
- ▶ Check the transmission position in the instrument cluster display (▷ page 119).
- ▶ Leave the engine running during the entire towing procedure.

Transporting the vehicle

The towing eye can be used to pull the vehicle onto a trailer or transporter for transporting purposes.

- !** Only lash the vehicle down by the wheels or wheel rims, not by parts of the vehicle such as axle or steering components. Otherwise, the vehicle could be damaged.

- ▶ Start the engine.
- ▶ Make sure that the SmartKey is in position **2** in the ignition and that the engine is running during the entire loading operation.
- ▶ Move the transmission to **N** with the E-SELECT lever. Check the transmission position in the instrument cluster.

As soon as the vehicle is loaded:

- ▶ Prevent the vehicle from rolling away by applying the electric parking brake.
- ▶ Shift the transmission to **P** with the button in the center console.
- ▶ Turn the SmartKey to position **0** in the ignition lock and remove the SmartKey from the ignition lock.
- ▶ Secure the vehicle.

Fuses

Important safety notes

WARNING

Only use fuses approved by Mercedes-Benz with the specified amperage for the system in question and do not attempt to repair or bridge a blown fuse. Using other than approved fuses or using repaired or bridged fuses may cause an overload leading to a fire, and/or cause damage to electrical components and/or systems. Have the cause determined and remedied by an authorized Mercedes-Benz Center.

- !** Only use fuses that have been approved for Mercedes-Benz vehicles and which have the correct fuse rating for the system concerned. Otherwise, components or systems could be damaged.

The fuses in your vehicle serve to close down faulty circuits. If a fuse blows, all the components on the circuit and their functions stop operating.

Blown fuses must be replaced with fuses of the same rating, which you can recognize by the color and value. The fuse ratings are listed

in the fuse allocation chart. An authorized Mercedes-Benz Center will be happy to advise you.

- ❗ If a fuse has blown, contact a breakdown service or an authorized Mercedes-Benz Center.

If the newly inserted fuse also blows, have the cause traced and rectified at a qualified specialist workshop, e.g. an authorized Mercedes-Benz Center.

Before changing a fuse

- ▶ Park the vehicle and apply the electric parking brake.
- ▶ Switch off all electrical consumers.
- ▶ Remove the SmartKey from the ignition lock.

The fuses are located in various fuse boxes:

- fuse box in the footwell on the front-passenger side
- fuse box in the rear

The "Relay and fuse information sheet" is located with the wheel-change toolkit in the trunk.

Fuse box in the footwell

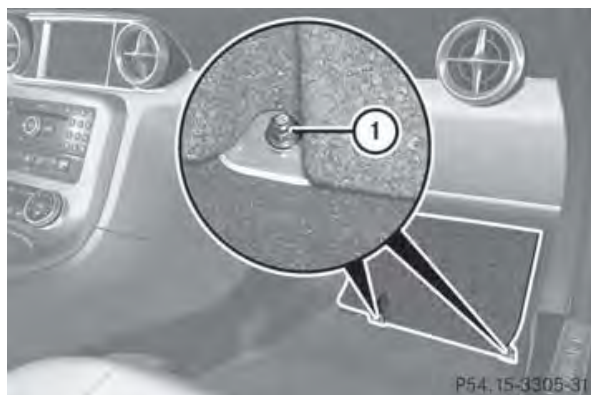

- ▶ **To open:** remove the carpet over the footrest.
- ▶ Loosen screws (1) on the floor panel using a suitable tool.
- ▶ Remove the floor panel.

- ▶ **To close:** install the floor panel again.
- ▶ Screw in and tighten screws (1).
- ▶ Put in the carpet and press to secure.

- ❗ The floor panel must be installed properly, otherwise moisture or dirt could impair the function of the fuses.

Fuse box in the rear

Coupe



- ▶ **To open:** open the trunk.
- ▶ Fold cover (1) in the center of the rear wall down in the direction of the arrow.
- ▶ **To close:** fold cover (1) up in the opposite direction to the arrow and press to secure.

- ❗ The cover must be installed properly, otherwise moisture or dirt could impair the function of the fuses.

Roadster



- ▶ **To open:** from the vehicle interior, lift up cover ① between the roll bars in the direction of the arrow.
 - ▶ **To close:** shut cover ① in the opposite direction to the arrow and press to secure.
- !** The cover must be installed properly, otherwise moisture or dirt could impair the function of the fuses.

Useful information	248
Important safety notes	248
Operation	248
Winter operation	250
Tire pressure	251
Loading the vehicle	258
Maximum load rating	261
Uniform Tire Quality Grading Standards	261
Tire labeling	263
Definition of terms for tires and loading	266
Changing a wheel	269
Wheel and tire combinations	270

Useful information

- i** This Operator's Manual describes all models and all standard and optional equipment of your vehicle available at the time of publication of the Operator's Manual. Country-specific differences are possible. Please note that your vehicle may not be equipped with all features described. This also applies to safety-related systems and functions.
- i** Please read the information on qualified specialist workshops (▷ page 22).

Important safety notes

Consult an authorized Mercedes-Benz Center if you require information on approved and recommended tires and wheels for summer and winter operation. Advice on purchasing and caring for tires is also available there.

WARNING

Replace rims or tires with the same designation, manufacturer and type as shown on the original part. For further information contact an authorized Mercedes-Benz Center. If incorrectly sized rims and tires are mounted, the wheel brakes or suspension components can be damaged. Also, the operating clearance of the wheels and the tires may no longer be correct.

WARNING

Worn, old tires can cause accidents. If the tire tread is worn to minimum tread depth, or if the tires have sustained damage, replace them.

When replacing rims, only use genuine Mercedes-Benz wheel bolts specified for the particular rim type. Failure to do so can result in the bolts loosening and possibly an accident.

Retreaded tires are not tested or recommended by Mercedes-Benz, since previous damage cannot always be

recognized on retreads. The operating safety of the vehicle cannot be assured when such tires are used.

WARNING

If you feel a sudden significant vibration or ride disturbance, or you suspect that possible damage to your vehicle has occurred, you should turn on the hazard warning flashers, carefully slow down, and drive with caution to an area which is a safe distance from the road. Inspect the tires and the vehicle underbody for possible damage. If the vehicle appears unsafe, have the vehicle towed to the nearest authorized Mercedes-Benz Center or tire dealer for repairs.

WARNING

Do not drive with a flat tire. A flat tire affects the ability to steer or brake the vehicle. You might lose control of the vehicle. Continued driving with a flat tire or driving at high speed with a flat tire will cause excessive heat build-up and possibly a fire.

- i** Further information about tires and wheels can be obtained from any authorized Mercedes-Benz Center.

Operation

Notes on driving

- If the vehicle is heavily loaded, check the tire pressures and correct them if necessary.
- When parking your vehicle, make sure that the tires do not get deformed by the curb or other obstacles. If it is necessary to drive over curbs, speed humps or similar elevations, try to do so slowly and at an obtuse angle. Otherwise, the tires, particularly the sidewalls, may be damaged.

Notes on high performance tires

 **WARNING**

Due to the special tire tread in combination with the optimized rubber compound, there is an increased risk of hydroplaning and skidding on a damp or wet road surface. Tire grip is also noticeably reduced at low outside temperatures and low tire operating temperatures. There is a risk of an accident. Turn on ESP® and adapt your driving style accordingly. When the outside temperature falls below 10 °C, use M+S tires.

- i** Different driving styles may lead to high tire wear and the tires may reach the minimum tire tread depth after only a short time.

Notes on regularly inspecting wheels and tires

 **WARNING**

Regularly check the tires for damage. Damaged tires can cause tire inflation pressure loss. As a result, you could lose control of your vehicle.

Worn, old tires can cause accidents. If the tire tread is worn to minimum tread depth, or if the tires have sustained damage, replace them.

- Regularly check the wheels and tires of your vehicle for damage (e.g. cuts, punctures, tears, bulges on tires and deformation or cracks or severe corrosion on wheels) at least once a month, as well as after driving off-road or on rough roads. Damaged wheels can cause a loss of tire pressure.
- Regularly check the tire tread depth and the condition of the tread across the whole width of the tire (▷ page 249). If necessary, turn the front wheels to full lock in order to inspect the inner side of the tire surface.

- All wheels must have a valve cap to protect the valve against dirt and moisture. Do not install anything on the valve (such as tire pressure monitoring systems) other than the standard valve cap or other valve caps approved by Mercedes-Benz for your vehicle.
- Regularly check the pressure of all the tires including the emergency spare wheel or the spare wheel, particularly prior to long trips, and correct the pressure as necessary (▷ page 251).

Tire tread

 **WARNING**

Although the applicable federal motor vehicle safety laws consider a tire to be worn when the tread wear indicators (TWI) become visible at approximately $\frac{1}{16}$ in (1.6 mm), we recommend that you do not allow your tires to wear down to that level. As tread depth approaches $\frac{1}{8}$ in (3 mm), the adhesion properties on a wet road are sharply reduced. Depending upon the weather and/or road surface (conditions), the tire traction varies widely.

Do not use tires until they are excessively worn as the tire traction on wet road surfaces decreases significantly when the tread depth is less than $\frac{1}{8}$ in (3 mm).

Treadwear indicators (TWI) are required by law. Six indicators are positioned on the tire tread. They are visible once the tread depth is approximately $\frac{1}{16}$ in (1.6 mm). If this is the case, the tire is so worn that it must be replaced.

The recommended tread depth for summer tires is at least $\frac{1}{8}$ in (3 mm). The recommended tread depth for winter tires is at least $\frac{1}{6}$ in (4 mm).

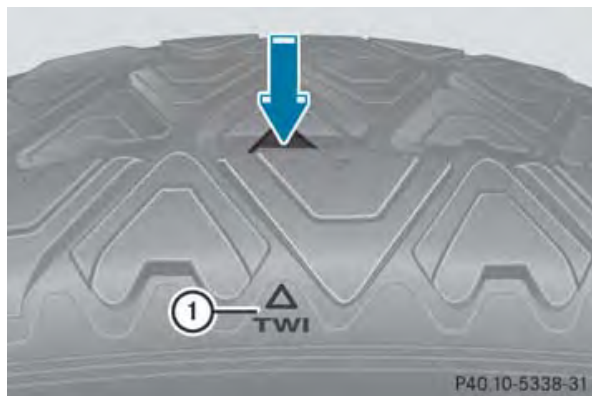

Bar indicator ① for tread wear is integrated into the tire tread.

Notes on selecting, mounting and replacing tires

- Only mount tires and wheels of the same type and make.
- Only mount tires of the correct size onto the wheels.
- After mounting new tires, break them in at moderate speeds for the first 60 miles (100 km), as they only reach their full performance after this distance.
- Do not use tires until they are excessively worn as the tire traction on wet road surfaces decreases significantly when the tread depth is less than $\frac{1}{8}$ in (3 mm).
- Replace the tires after six years at the latest, regardless of wear. This also applies to the spare wheel/emergency spare wheel.

The service life of tires depends on the following factors amongst other things:

- Driving style
- Tire pressure
- Distance covered

Winter operation

General notes

Have your vehicle winterproofed at a qualified specialist workshop at the onset of winter.

Observe the notes in the "Changing a wheel" section (▷ page 269).

Driving with summer tires

At temperatures below 45 °F (+7 °C), summer tires lose elasticity and therefore traction and braking power. Change the tires on your vehicle to M+S tires. Using summer tires at very cold temperatures could cause cracks to form, thereby damaging the tires permanently. Mercedes-Benz cannot accept responsibility for this type of damage.

Snow chains

WARNING

If snow chains are installed to the front wheels, they may drag against the vehicle body or chassis components. This could cause damage to the vehicle or the tires. There is a risk of an accident.

To avoid hazardous situations:

- never install snow chains to the front wheels
- always install snow chains in pairs to the rear wheels.

! There is not enough space for snow chains on some wheel sizes. Observe the information under "Tires and wheels" in the "Technical Data" section to avoid damage to the vehicle or the wheels.

For safety reasons, Mercedes-Benz recommends that you only use snow chains that have been specially approved for your vehicle by Mercedes-Benz, or are of a corresponding standard of quality.

- You may not mount snow chains to all wheel-tire combinations; see the information under "Wheels and tires" in the "Technical data" section.
- Only use snow chains when driving on roads completely covered by snow. Remove the snow chains as soon as

possible when you come to a road that is not snow-covered.

- Local regulations may restrict the use of snow chains. Observe the appropriate regulations if you wish to mount snow chains.
- Do not exceed the maximum permissible speed of 30 mph (50 km/h).
- Snow chains must not be mounted on emergency spare wheels.

i You may wish to deactivate ESP® (▷ page 56) when pulling away with snow chains installed. You can thereby allow the wheels to spin in a controlled manner, achieving an increased driving force (cutting action).

M+S tires

WARNING

M+S tires with a tread depth of less than $\frac{1}{6}$ inch (4 mm) must be replaced. They are no longer suitable for winter operation.

WARNING

If you mount the spare wheel when driving with M+S tires, bear in mind that driving stability will be impaired due to unstable cornering characteristics caused by the different tire characteristics. Adapt your style of driving accordingly.

Have the spare wheel replaced by a normal wheel with an M+S tire at the nearest Mercedes-Benz Center.

At temperatures below 45 °F (+7 °C), use all-season tires or winter tires. Both types of tire are identified by the M+S marking.

Only winter tires bearing the  snowflake symbol in addition to the M+S marking provide the best possible grip in wintry road conditions. Only these tires will allow driving safety systems such as ABS and ESP® to function optimally in winter. This is because

these tires were specifically developed for driving in snow.

Use M+S tires of the same make and tread on all wheels to maintain safe handling characteristics.

Always observe the maximum permissible speed specified for the M+S tires you have mounted.

When you have mounted the M+S tires:

- ▶ Check the tire pressures (▷ page 251).
- ▶ Restart the tire pressure monitor (▷ page 257).

Tire pressure

Tire pressure specifications

WARNING

Follow recommended tire inflation pressures.

Do not underinflate tires. Underinflated tires wear excessively and/or unevenly, adversely affect handling and fuel economy, and are more likely to fail from being overheated.

Do not overinflate tires. Overinflated tires can adversely affect handling and ride comfort, wear unevenly, increase stopping distance, and result in sudden deflation (blowout) because they are more likely to become punctured or damaged by road debris, potholes etc.

Do not overload the tires by exceeding the specified load limit as indicated on the Tire and Loading Information placard on the driver's door B-pillar. Overloading the tires can overheat them, possibly causing a blowout. Overloading the tires can also result in handling or steering problems, or brake failure.

You will find a table of recommended tire pressures on the Tire and Loading Information placard on the B-pillar on the driver's side (▷ page 258). You will find a table of tire pressure for various operating conditions on the inside of your vehicle's fuel filler flap.

To test tire pressure, use a suitable pressure gauge. The outer appearance of a tire does not permit any reliable conclusion about the tire pressure. On vehicles equipped with the electronic tire pressure monitor, the tire pressure can be checked in the on-board computer.

WARNING

Should the tire pressure drop repeatedly:

- check the tire for foreign bodies.
- check whether the wheel is losing air or the valve is leaking.
- make sure that only a valve cap approved by Mercedes-Benz is installed on the tire valve.

Tire pressures that are too low have a negative effect on vehicle safety, which could lead you to cause an accident.

Only correct tire pressures when the tires are cold. The tires are cold when the vehicle has been parked for at least three hours or driven for less than 1 mile (1.6 km). The tire temperature changes depending on the outside temperature, the vehicle speed and the tire load. If the tire temperature changes by 18 °F (10 °C), the tire pressure changes by approximately 10 kPa (0.1 bar/1.5 psi). Take this into account when checking the pressure of warm tires and only correct the tire pressure if it is too low for the current operating conditions. If you check the tire pressure when the tires are warm, the resulting value will be higher than if the tires were cold. This is normal. Do not reduce the tire pressure to the value specified for cold tires. The tire pressure would otherwise be too low.

Observe the recommended tire pressure specifications for cold tires on the Tire and Loading Information placard on the B-pillar on the driver's side.

- i** The specifications given on the following Tire and Loading Information placard are examples. Tire pressure specifications are vehicle-specific and may deviate from the

data shown here. The tire pressures applicable to your vehicle can be found on the Tire and Loading Information placard on your vehicle.

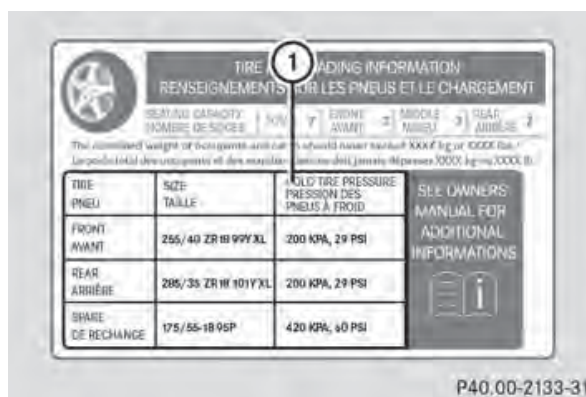

The Tire and Loading Information placard shows recommended tire pressure specifications **1** for cold tires when the vehicle is fully laden. The tire pressure specifications apply to tires which are mounted at the factory.

Important notes on tire pressure

WARNING

If the tire pressure drops repeatedly, check the tires for punctures from foreign objects and/or whether air is leaking from the valves or from around the rim.

The tire temperature and pressure increase when the vehicle is in motion. This is dependent on the driving speed and the load. If you wish to drive at high speeds of 100 mph (160 km/h) or higher when this is allowed, use the tire pressure table on the inside of the fuel filler flap to set the correct tire pressures when the wheels are cold. If the tire pressure is not set correctly, this can lead to an excessive build-up of heat and a sudden loss of pressure.

For more information, contact a qualified specialist workshop.

- i** Driving comfort can be impaired if the tire pressure value recommended in the tire

pressure table for speeds over 100 mph (160 km/h) is adopted.

Make sure that the tire pressure for normal speeds is adopted again.

Additional specifications of tire pressure values for loads can also be found on the tire pressure table on the inside of the fuel filler flap.

i Specifications shown in the examples of tire pressure tables are for illustration purposes only. Tire pressure specifications are vehicle-specific and may deviate from the data shown here. Tire pressure specifications applicable to your vehicle are located in your vehicle's tire pressure table.

Unless stated otherwise, the tire pressures specified on the fuel filler flap apply to all tires approved for this vehicle.

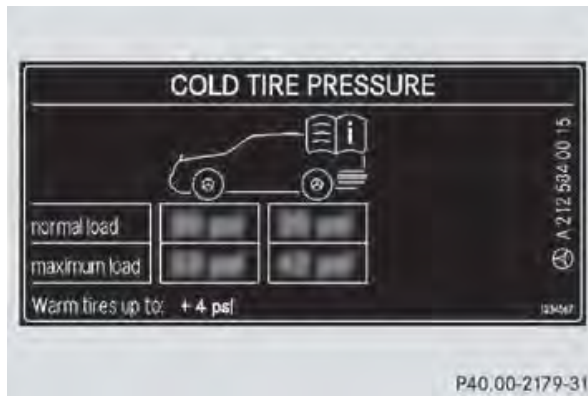

Example: tire pressure table for all tires permitted for this vehicle by the factory

If a tire size precedes a tire pressure, the tire pressure information following is only valid for that tire size. The load conditions "partially laden" and "fully laden" are defined in the table for different numbers of passengers and amounts of luggage. The actual number of seats may differ.

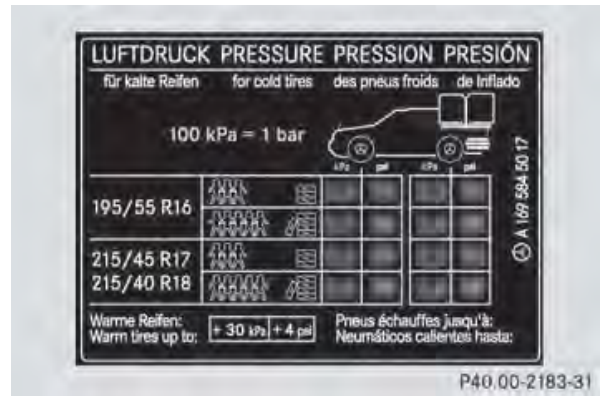

Example: tire pressure table with tire dimensions
Some tire pressure tables show only the rim diameters instead of the full tire size, e.g. **R18**. The rim diameter is part of the tire size and can be found on the tire sidewall (▷ page 263).

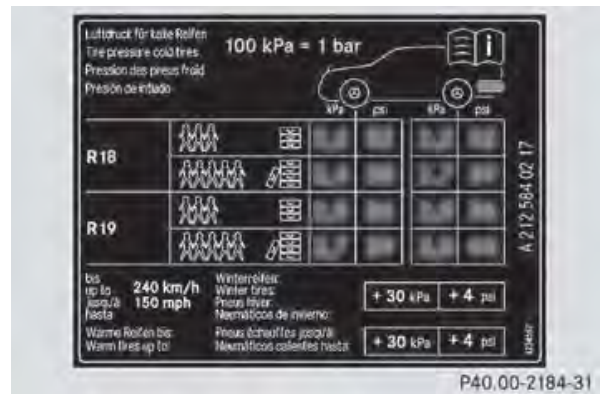

Underinflated or overinflated tires

Underinflation

⚠ WARNING

Follow recommended tire inflation pressures. Do not underinflate tires. Underinflated tires wear excessively and/or unevenly, adversely affect handling and fuel economy, and are more likely to fail from being overheated.

Underinflated tires may:

- wear quickly and unevenly
- have an adverse effect on fuel consumption
- overheat, leading to tire defects
- have an adverse effect on handling characteristics

Overinflation

WARNING

Follow recommended tire inflation pressures. Do not overinflate tires. Overinflated tires can adversely affect handling and ride comfort, wear unevenly, increase stopping distance, and result in sudden deflation (blowout) because they are more likely to become punctured or damaged by road debris, potholes etc.

Overinflated tires may:

- have an adverse effect on handling characteristics
- wear quickly and unevenly
- be more susceptible to damage
- have an adverse effect on ride comfort
- increase the braking distance

Maximum tire pressure

WARNING

Never exceed the maximum tire inflation pressure. Follow recommended tire inflation pressures.

Do not underinflate tires. Underinflated tires wear excessively and/or unevenly, adversely affect handling and fuel economy, and are more likely to fail from being overheated.

Do not overinflate tires. Overinflated tires can adversely affect handling and ride comfort, wear unevenly, increase stopping distance, and result in sudden deflation (blowout) because they are more likely to become punctured or damaged by road debris, potholes etc.



① Example: maximum permissible tire pressure

 The actual values for tires are vehicle-specific and may deviate from the values in the illustration.

Always observe the recommended tire pressure for your vehicle when adjusting the tire pressure (▷ page 251).

Checking the tire pressures

Important safety notes

WARNING

Follow recommended tire inflation pressures.

Do not underinflate tires. Underinflated tires wear excessively and/or unevenly, adversely affect handling and fuel economy, and are more likely to fail from being overheated.

Do not overinflate tires. Overinflated tires can adversely affect handling and ride comfort, wear unevenly, increase stopping distance, and result in sudden deflation (blowout) because they are more likely to become punctured or damaged by road debris, potholes etc.

Do not overload the tires by exceeding the specified load limit as indicated on the Tire and Loading Information placard on the driver's door B-pillar. Overloading the tires can overheat them, possibly causing a blowout. Overloading the tires can also result in handling or steering problems, or brake failure.

Check the tire pressures at least once a month.

Only check and correct tire pressures when the tires are cold (▷ page 251).

Checking tire pressures manually

To determine and set the correct tire pressure, proceed as follows:

- ▶ Remove the valve cap of the tire that is to be checked.
- ▶ Press the tire pressure gauge securely onto the valve.
- ▶ Read the tire pressure and compare it with the recommended value on the Tire and Loading Information placard on the B-pillar on the driver's side of your vehicle.
- ▶ If necessary, increase the tire pressure to the recommended value (▷ page 251).
- ▶ If the tire pressure is too high, release air by pressing down the metal pin in the valve using the tip of a pen, for example. Then check the tire pressure again using the tire pressure checker.
- ▶ Screw the valve cap onto the valve.
- ▶ Repeat these steps for the other tires.

Tire pressure monitor

Important safety notes

If a tire pressure monitor system is installed, the vehicle's wheels have sensors that monitor the tire pressures in all four tires. The tire pressure monitor warns you if the pressure drops in one or more of the tires. The tire pressure monitor only functions if the correct wheel electronics units are installed on each wheel.

The tire pressure monitor has a yellow warning lamp in the instrument cluster for indicating pressure loss/malfunctions (USA) or pressure loss (Canada). Whether the warning lamp flashes or lights up indicates whether a tire pressure is too low or the tire pressure monitoring system is malfunctioning:

- if the warning lamp is lit continuously, the tire pressure on one or more tires is significantly too low. The tire pressure monitor is not malfunctioning.
- USA only: if the warning lamp flashes for 60 seconds and then remains lit constantly, the tire pressure monitor is malfunctioning.

WARNING

Each tire, including the spare (if provided), should be checked at least once a month when cold and inflated to the pressure recommended by the vehicle manufacturer on the Tire and Loading Information placard on the driver's door B-pillar or the tire pressure label on the inside of the fuel filler flap. If your vehicle has tires of a different size than the size indicated on the Tire and Loading Information placard or the tire pressure label, you should determine the proper tire pressure for those tires.

As an added safety feature, your vehicle has been equipped with a tire pressure monitoring system (TPMS) that illuminates a low tire pressure telltale when one or more of your tires are significantly underinflated.

Accordingly, when the low tire pressure telltale illuminates, you should stop and check your tires as soon as possible, and inflate them to the proper pressure. Driving on a significantly underinflated tire causes the tire to overheat and can lead to tire failure.

Underinflation also reduces fuel efficiency and tire tread life, and may affect the vehicle's handling and stopping ability. Please note that the TPMS is not a substitute for proper tire maintenance, and it is the driver's responsibility to maintain correct tire pressure, even if underinflation has not

reached the level to trigger illumination of the TPMS low tire pressure telltale.

USA only:

Your vehicle has also been equipped with a TPMS malfunction indicator to indicate when the system is not operating properly. The TPMS malfunction indicator is combined with the low tire pressure telltale. When the system detects a malfunction, the telltale will flash for approximately 1 minute and then remain continuously illuminated. This sequence will continue upon subsequent vehicle start-ups as long as the malfunction exists. When the malfunction indicator is illuminated, the system may not be able to detect or signal low tire pressure as intended. TPMS malfunctions may occur for a variety of reasons, including the installation of incompatible replacement or alternate tires or wheels on the vehicle that prevent the TPMS from functioning properly. Always check the TPMS malfunction telltale after replacing one or more tires or wheels on your vehicle to ensure that the replacement or alternate tires and wheels allow the TPMS to continue to function properly.

i USA only:

If the tire pressure monitor is malfunctioning, it may take more than 10 minutes for the tire pressure warning lamp to inform you of the malfunction by flashing for 60 seconds and then remaining lit.

When the malfunction has been rectified, the tire pressure warning lamp goes out after a few minutes of driving.

Information on tire pressures is displayed in the multifunction display. After a few minutes of driving, the current tire pressure of each tire is shown in the multifunction display.

i The tire pressure values indicated by the on-board computer may differ from those measured at a gas station with a pressure gauge. The tire pressures shown by the on-board computer refer to those measured at

sea level. At high altitudes, the tire pressure values indicated by a pressure gauge are higher than those shown by the on-board computer. In this case, do not reduce the tire pressures.

i The operation of the tire pressure monitor can be affected by interference from radio transmitting equipment (e.g. radio headphones, two-way radios) that may be being operated in or near the vehicle.

i USA only:

This device complies with Part 15 of the FCC Rules. Operation is subject to the following two conditions:

1. This device may not cause interference, and
2. this device must accept any interference received, including interference that may cause undesired operation.

Any unauthorized modification to this device could void the user's authority to operate the equipment.





i Canada only:

This device complies with RSS-210 of Industry Canada. Operation is subject to the following two conditions:

1. This device may not cause interference, and
2. this device must accept any interference received, including interference that may cause undesired operation of the device.

Any unauthorized modification to this device could void the user's authority to operate the equipment.

Checking tire pressure electronically

- ▶ Select key position **2** with the Start/Stop button (▷ page 113).
- ▶ Press the  or  button to select the **Service** menu.
- ▶ Press the  or  button to select **TIRE PRESS..**
- ▶ Press the  button.

The current tire pressure for each wheel will be displayed in the multifunction display.

If the vehicle is parked for longer than 20 minutes and you then drive at less than 25 km/h, the **Tire pressures will be displayed after driving a few minutes** message appears.

After a teach-in period, the tire pressure monitor automatically recognizes new wheels or new sensors. As long as a clear allocation of the tire pressure values to the individual wheels is not possible, the **Tire Pressure Monitor Active** display message is shown instead of the tire pressure display. The tire pressures are already being monitored.

Tire pressure monitor warning messages

If the tire pressure monitor detects a significant pressure loss on one or more tires, a warning message is shown in the multifunction display. A warning tone also sounds and the tire pressure warning lamp lights up in the instrument cluster.

Each tire that is affected by a significant loss of pressure is highlighted with a color.

If the following message appears in the multifunction display: **Correct Tire Pressure**

- ▶ Check the tire pressure on all four wheels and correct it if necessary.

i If the wheel positions on the vehicle are interchanged, the tire pressures may be displayed for the wrong positions for a short time. This is rectified after a few minutes of driving, and the tire pressures are displayed for the correct positions.

Restarting the tire pressure monitor

When you restart the tire pressure monitor, all existing warning messages are deleted and the warning lamps go out. The monitor uses the currently set tire pressures as the specified values for monitoring.







In most cases, the tire pressure monitor will automatically detect the new reference values, e.g. if you have:

- changed the tire pressure
- changed the wheels or tires
- mounted new wheels or tires

If you are defining the new reference values manually:

- ▶ Use the table on the inside of the fuel filler flap to ensure that the tire pressure is set correctly in all four tires for the current operating conditions.



Also observe the notes in the section on tire pressures (▷ page 251).

- ▶ Select key position **2** with the Start/Stop button.
- ▶ Press the  or  button to select the **Service** menu.
- ▶ Press the  or  button to select **TIRE PRESS..**
- ▶ Press the  button.
The display shows either the current tire pressure for the individual tires or the **Tire pressures will be displayed after driving a few minutes** message.
- ▶ Press the  button.
The **Use Current Pressures as New Reference Values** message appears in the multifunction display.

- ▶ Press the  button.
The **Tire Press. Monitor Restarted** message appears in the multifunction display.

After a few minutes of driving, the current pressures are adopted as the new monitoring values.

Canceling the restart

- ▶ Press the  button.
- or
- ▶ Press the  button to leave the menu.

Loading the vehicle

Instruction labels for tires and loads

WARNING

Do not overload the tires by exceeding the specified load limit as indicated on the Tire and Loading Information placard on the driver's door B-pillar. Overloading the tires can overheat them, possibly causing a blowout. Overloading the tires can also result in handling or steering problems, or brake failure.

Two instruction labels on your vehicle show the maximum possible load.

- (1) The Tire and Loading Information placard is on the B-pillar on the driver's side. The Tire and Loading Information placard shows the maximum permissible number of occupants and the maximum permissible vehicle load. It also contains details of the tire sizes and corresponding pressures for tires installed at the factory.
- (2) The vehicle identification plate is on the B-pillar on the driver's side. The vehicle identification plate informs you of the gross vehicle weight rating. It is made up of the vehicle weight, all vehicle occupants, the fuel and the cargo. You can also find information about the maximum gross axle weight rating on the front and rear axle.

The maximum gross axle weight rating is the maximum weight that can be carried by one axle (front or rear axle). Never exceed the maximum load or the maximum gross axle weight rating for the front or rear axle.



① B-pillar, driver's side

Maximum permissible gross vehicle weight rating

- ① The specifications shown on the Tire and Loading Information placard in the illustration are examples. The maximum permissible gross vehicle weight rating is vehicle-specific and may differ from that in the illustration. You can find the valid maximum permissible gross vehicle weight rating for your vehicle on the Tire and Loading Information placard.

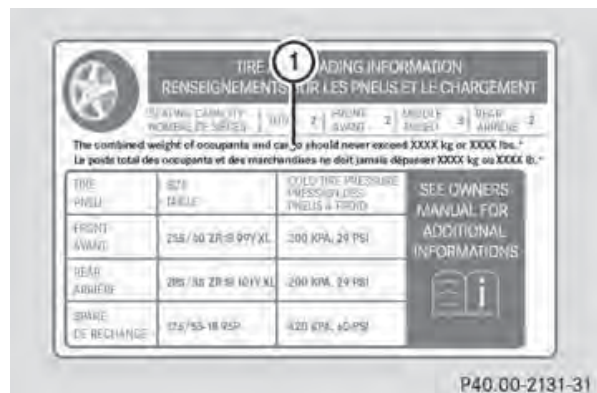

- The Tire and Loading Information placard gives you details on maximum permissible gross vehicle weight rating ①: "The gross weight of occupants and luggage must never exceed XXX kilograms or XXX pounds."

The gross weight of all vehicle occupants, cargo, luggage and trailer load/noseweight (if applicable) must not exceed the specified value.

Number of seats

- i** The specifications shown on the Tire and Loading Information placard in the illustration are examples. The number of seats is vehicle-specific and can differ from the details shown. The number of seats in your vehicle can be found on the Tire and Loading Information placard.

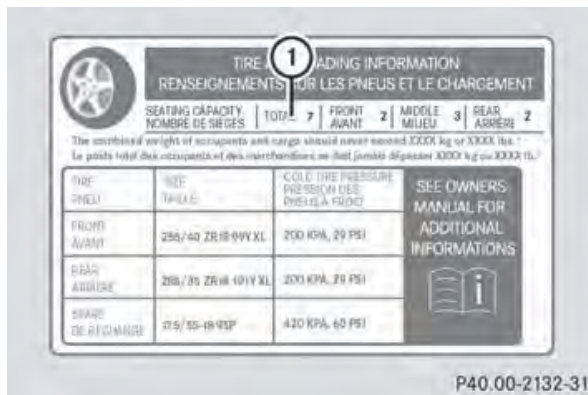

Maximum number of seats ① determines the maximum number of occupants allowed to travel in the vehicle. This information can be found on the Tire and Loading Information placard.

Determining the correct load limit

Step-by-step instructions

The following steps have been developed as required of all manufacturers under Title 49, Code of U.S. Federal Regulations, Part 575 pursuant to the "National Traffic and Motor Vehicle Safety Act of 1966".

- **Step 1:** Locate the statement "The combined weight of occupants and cargo should never exceed XXX kg or XXX lbs." on your vehicle's Tire and Loading Information placard.
- **Step 2:** Determine the combined weight of the driver and passengers that will be riding in your vehicle.
- **Step 3:** Subtract the combined weight of the driver and passengers from XXX kilograms or XXX lbs.

- **Step 4:** The resulting figure equals the available amount of cargo and luggage load capacity. For example, if the "XXX" amount equals 1400 lbs and there will be five 150 lb passengers in your vehicle, the amount of available cargo and luggage load capacity is 650 lbs ($1400 - 750 (5 \times 150) = 650$ lbs).
- **Step 5:** Determine the combined weight of luggage and cargo being loaded on the vehicle. That weight may not safely exceed the available cargo and luggage load capacity calculated in step 4.
- **Step 6 (if applicable):** If your vehicle will be towing a trailer, load from your trailer will be transferred to your vehicle. Consult this manual to determine how this reduces the available cargo and luggage load capacity of your vehicle (► page 261).

Example: steps 1 to 3

The following table shows examples on how to calculate total load and cargo capacities with varying seating configurations and number and size of occupants. The following examples use a load limit of 1500 lbs (680 kg). **This is for illustration purposes only.** Make sure you are using the actual load limit for your vehicle stated on the vehicle's Tire and Loading Information placard (▷ page 259).

		Example 1	Example 2
Step 1	Combined maximum weight of occupants and cargo (data from the Tire and Loading Information placard)	1500 lbs (680 kg)	1500 lbs (680 kg)

		Example 1	Example 2
Step 2	Number of people in the vehicle (driver and occupants)	1	2
	Weight of the occupants	Occupant 1: 175 lbs (80 kg)	Occupant 1: 175 lbs (80 kg) Occupant 2: 195 lbs (88 kg)
	Gross weight of all occupants	175 lbs (80 kg)	370 lbs (168 kg)

		Example 1	Example 2
Step 3	Permissible cargo and trailer load/noseweight (maximum gross vehicle weight rating from the Tire and Loading Information placard minus the gross weight of all occupants)	1500 lbs (680 kg) - 175 lbs (80 kg) = 1325 lbs (600 kg)	1500 lbs (680 kg) - 370 lbs (168 kg) = 1130 lbs (512 kg)

The higher the weight of all the occupants, the smaller the maximum load for luggage. Further information can be found under "Towing a trailer" (▷ page 261).

Vehicle identification plate

Even if you have calculated the total load carefully, you should still make sure that the gross vehicle weight rating and the gross axle

weight rating are not exceeded. Details can be found on the vehicle identification plate on the B-pillar on the driver's side of the vehicle (▷ page 258).

Gross vehicle weight: the gross weight of the vehicle, all passengers, cargo and trailer load/noseweight (if applicable) must not exceed the permissible gross vehicle weight.

Gross axle weight rating: the maximum permissible weight that can be carried by one axle (front or rear axle).

To ensure that your vehicle does not exceed the maximum permissible values (gross vehicle weight and maximum gross axle weight rating), have your loaded vehicle (including driver, occupants, cargo, and full trailer load if applicable) weighed on a suitable vehicle weighbridge.

Trailer load/noseweight

The trailer load/noseweight affects the gross weight of the vehicle. If a trailer is attached, the trailer load/noseweight is included in the load along with occupants and luggage. The trailer load/noseweight is usually approximately 10% of the gross weight of the trailer and its load.

Your Mercedes-Benz has been designed primarily to carry passengers and their luggage. Mercedes-Benz does not recommend towing a trailer with your vehicle.

Maximum load rating

⚠ WARNING

Do not overload the tires by exceeding the specified load limit as indicated on the Tire and Loading Information placard on the driver's door B-pillar. Overloading the tires can overheat them, possibly causing a blowout. Overloading the tires can also result in handling or steering problems, or brake failure.



i The actual values for tires are vehicle-specific and may deviate from the values in the illustration.

Maximum tire load ① is the maximum permissible weight for which the tire is approved.

Further information on tire loads (▷ page 263).

Uniform Tire Quality Grading Standards

Overview of Tire Quality Grading Standards

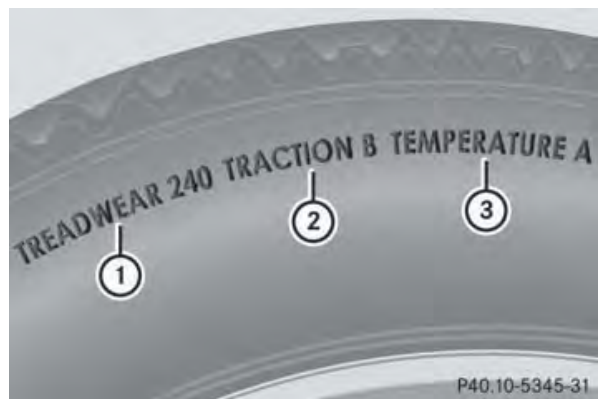

Uniform Tire Quality Grading Standards are U.S. government specifications. Their purpose is to provide drivers with uniform reliable information on tire performance data. Tire manufacturers have to grade tires using three performance factors: tread wear ①, tire traction ②, and heat resistance ③. All tires sold in North America are provided with the corresponding quality class mark on the

sidewall of the tire, even though these regulations do not apply to Canada.

i The actual values for tires are vehicle-specific and may deviate from the values in the illustration.

Where applicable, the tire grading information can be found on the tire sidewall between the tread shoulder and maximum tire width.

For example:

Tread wear	Traction	Temperature
200	AA	A

All passenger car tires must conform to the statutory safety requirements in addition to these grades.

Tread wear

The tread wear grade is a comparative rating based on the wear rate of the tire when tested under controlled conditions on a specified U.S. government course. For example, a tire graded 150 would wear one and one-half times as well on the government test track as a tire graded 100.

The relative performance of tires depends upon the actual conditions of their use, however, and may depart significantly from the norm, due to variations in driving habits, service practices and differences in road characteristics and climate conditions.

Traction

WARNING

The traction grade assigned to this tire is based on straight-ahead braking traction tests, and does not include acceleration, cornering, hydroplaning, or peak traction characteristics.

The traction grades, from highest to lowest, are AA, A, B, and C. Those grades represent

the tire's ability to stop on a wet surface as measured under controlled conditions on specified government test surfaces of asphalt and concrete. A tire marked C may have poor traction performance.

WARNING

If ice has formed on the road, tire traction will be substantially reduced. Under such weather conditions, drive, steer and brake with extreme caution.

The safe speed on a wet, snow covered or icy road is always lower than on dry road surfaces.

You should pay special attention to road conditions when temperatures are around freezing point.

Mercedes-Benz recommends a minimum tire tread depth of $\frac{1}{6}$ in (4 mm) for all four winter tires (▷ page 251) to maintain normal driving characteristics in winter. Winter tires can reduce the braking distance on snow-covered surfaces in comparison with summer tires. The braking distance is still much further than on surfaces that are not icy or covered with snow. Take appropriate care when driving.

! Avoid wheelspin. This can lead to damage to the drive train.

Temperature

WARNING

The temperature grade for this tire is established for a tire that is properly inflated and not overloaded. Excessive speed, underinflation, or excessive loading, either separately or in combination, can cause excessive heat build-up and possible tire failure.

The temperature grades are A (the highest), B, and C. These represent the tire's resistance to the generation of heat and its ability to dissipate heat when tested under controlled conditions on a specified indoor

laboratory test wheel. Sustained high temperature can cause the material of the tire to degenerate and reduce tire life, and excessive temperature can lead to sudden tire failure. The grade C corresponds to a level of performance which all passenger car tires must meet under the Federal Motor Vehicle Safety Standard No. 109. Grades B and A represent higher levels of performance on the laboratory test wheel than the minimum required by law.

Tire labeling

Overview of tire labeling

The following markings are on the tire in addition to the tire name (sales designation) and the manufacturer's name:

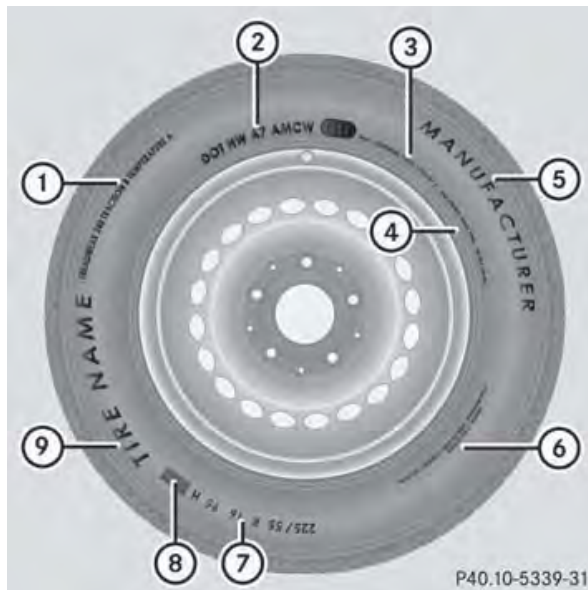

- ① Uniform Tire Quality Grading Standard (▷ page 267)
- ② DOT, Tire Identification Number (▷ page 266)
- ③ Maximum tire load (▷ page 261)
- ④ Maximum tire pressure (▷ page 254)
- ⑤ Manufacturer
- ⑥ Tire material (▷ page 266)
- ⑦ Tire size designation, load-bearing capacity and speed rating (▷ page 263)

- ⑧ Load index (▷ page 265)
- ⑨ Tire name
- ⓘ Tire data is vehicle-specific and may deviate from the data in the example.

Tire size designation, load-bearing capacity and speed rating



- ① Tire width
- ② Nominal aspect ratio in %
- ③ Tire code
- ④ Rim diameter
- ⑤ Load bearing index
- ⑥ Speed rating
- ⓘ Tire data is vehicle-specific and may deviate from the data in the example.

General: depending on the manufacturer's standards, the size imprinted in the tire wall may not contain any letters or may contain one letter that precedes the size description. If there is no letter preceding the size description (as shown above): these are passenger vehicle tires according to European manufacturing standards. If "P" precedes the size description: these are passenger vehicle tires according to U.S. manufacturing standards. If "LT" precedes the size description: these are light truck tires according to U.S. manufacturing standards. If "T" precedes the size description: these are compact emergency spare wheels at high tire

pressure, to be used only temporarily in an emergency.

Tire width: tire width ① shows the nominal tire width in millimeters.

Nominal aspect ratio: aspect ratio ② is the ratio between the tire height and tire width and is shown as a percentage. The aspect ratio is calculated by dividing the tire width by the tire height.

Tire code: tire code ③ specifies the tire type. "R" represents radial tires; "D" represents diagonal tires; "B" represents diagonal radial tires.

Optionally, tires with a maximum speed of over 149 mph (240 km/h) may have "ZR" in the size description depending on the manufacturer (e.g. 245/40 ZR 18).

Rim diameter: rim diameter ④ is the diameter of the bead seat, not the diameter of the rim flange. The rim diameter is specified in inches (in).

Load bearing index: load bearing index ⑤ is a numerical code which specifies the maximum load-bearing capacity of a tire.

WARNING

The tire load rating must always be at least half of the GAWR of your vehicle. Otherwise, sudden tire failure may be the result which could cause an accident and/or serious injury to you or others.

Always replace rims and tires with rims and tires having the same specifications (designation, manufacturer and type) as shown on the original part.

WARNING

Do not overload the tires by exceeding the specified load limit as indicated on the Tire and Loading Information placard on the driver's door B-pillar. Overloading the tires can overheat them, possibly causing a blowout. Overloading the tires can also result in handling or steering problems, or brake failure.

Example:

The load bearing index 91 is equivalent to a maximum load of 1356 lbs (615 kg) that the tire can carry. For further information on the maximum tire load in kilograms and pounds, see (▷ page 261).

For further information on the load bearing index, see Load index (▷ page 265).

Speed rating: speed rating ⑥ specifies the approved maximum speed of the tire.

WARNING

Even when permitted by law, never operate a vehicle at speeds greater than the maximum speed rating of the tires.

Exceeding the maximum speed for which tires are rated can lead to sudden tire failure, causing loss of vehicle control and possibly resulting in an accident and/or serious personal injury and possible death, for you and for others.

Regardless of the speed rating, always observe the speed limits. Drive carefully and adapt your driving style to the traffic conditions.

Summer tires

Index	Speed rating
Q	Up to 100 mph (160 km/h)
R	Up to 106 mph (170 km/h)
S	Up to 112 mph (180 km/h)
T	Up to 118 mph (190 km/h)
H	Up to 130 mph (210 km/h)
V	Up to 149 mph (240 km/h)
W	Up to 168 mph (270 km/h)
Y	Up to 186 mph (300 km/h)
ZR...Y	Up to 186 mph (300 km/h)
ZR...(..Y)	Above 186 mph (300 km/h)
ZR	Above 149 mph (240 km/h)

- Optionally, tires with a maximum speed of over 149 mph (240 km/h) may have "ZR" in the size description depending on the manufacturer (e.g. 245/40 ZR 18).
The service specifications consist of load bearing index ⑤ and speed rating ⑥.
- If the size description of your tire includes "ZR" and there are no service specifications, ask the tire manufacturer in order to find out the maximum speed.
If a service specification is available, the maximum speed is limited according to the speed rating in the service specification. Example: 245/40 ZR 18 97 Y. In this example, "97 Y" is the service specification. The letter "Y" represents the speed rating, and the maximum speed of the tire is limited to 186 mph (300 km/h).
- Every tire that has a maximum speed above 186 mph (300 km/h) must have "ZR" in the size description **and** the service specification must be given in brackets. Example: 275/40 ZR 18 (99 Y). The speed rating "(Y)" shows that the maximum speed of the tire is above 186 mph (300 km/h). Ask the tire manufacturer about the maximum speed.

All-weather tires and winter tires

Index	Speed rating
Q M+S ¹³	Up to 100 mph (160 km/h)
T M+S ¹³	Up to 118 mph (190 km/h)
H M+S ¹³	Up to 130 mph (210 km/h)
V M+S ¹³	Up to 149 mph (240 km/h)

i Not all tires that have the M+S identification offer the driving characteristics of winter tires. In addition to the M+S marking, winter tires also have the  snowflake symbol on the tire wall. Tires with this identification fulfill the requirements of the Rubber Manufacturers

Association (RMA) and the Rubber Association of Canada (RAC) regarding the tire traction on snow and have been especially developed for driving on snow.

The speed rating of tires mounted at the factory may be higher than the maximum speed that the electronic speed limiter permits.

Make sure that your tires have the required speed rating as specified in the "Tires" section (▷ page 270), e.g. if you buy new tires.

Further information about reading tire data can be obtained from any qualified specialist workshop.

Load index



i Tire data is vehicle-specific and may deviate from the data in the example.

In addition to the load-bearing index, load index ① may be imprinted after the letters that identify speed rating ⑥ (▷ page 263) on the sidewall of the tire.

- If no specification is given: no text (as in the example above), represents a standard load (SL) tire
- XL or Extra Load: represents a reinforced tire
- Light Load: represents a light load tire
- C, D, E: represents a load range that depends on the maximum load that the tire can carry at a certain pressure

¹³ Or M+S  for winter tires.

DOT, Tire Identification Number (TIN)

U.S. tire regulations prescribe that every manufacturer of new tires or retreader has to imprint a TIN in or on the sidewall of each tire produced.



The TIN is a unique identification number. The TIN enables tire manufacturers to inform purchasers of recalls and other safety-relevant matters. It makes it possible for the purchaser to easily identify the affected tires. The TIN is made up of manufacturer identification code (2), tire size (3), tire type code (4) and manufacturing date (5).

i Tire data is vehicle-specific and may deviate from the data in the example.

DOT (Department of Transportation): tire symbol (1) indicates that the tire complies with the requirements of the U.S. Department of Transportation.

Manufacturer identification code: manufacturer identification code (2) provides details on the tire manufacturer. New tires have a code with two symbols.

Tire size: identifier (3) describes the tire size.

Tire type code: tire type code (4) can be used by the manufacturer as a code to describe specific characteristics of the tire.

Date of manufacture: date of manufacture (5) provides information about the age of a tire. The first and second positions represent the week of manufacture, starting with "01" for the first calendar week. Positions three and four represent the year of manufacture.

For example, a tire that is marked with "3208" was manufactured in week 32 in 2008.

Tire characteristics

i Tire data is vehicle-specific and may deviate from the data in the example.

This information describes the tire cord and the number of layers in sidewall (1) and under tire tread (2).

Definition of terms for tires and loading**Tire ply composition and material used**

Describes the number of plies or the number of layers of rubber-coated fabric in the tire tread and sidewall. These are made of steel, nylon, polyester and other materials.

Bar

Metric unit for tire pressure. There are 14.5038 pounds per square inch (psi) to 1 bar; there are 100 kilopascals (kPa) to 1 bar.

DOT (Department of Transportation)

DOT marked tires fulfill the requirements of the United States Department of Transportation.

Normal occupant weight

The number of occupants the vehicle is designed to seat, multiplied by 68 kilograms (150 lbs).

Uniform Tire Quality Grading Standards

A uniform standard to grade the quality of tires with regards to tread quality, tire traction and temperature characteristics. The quality grading assessment is made by the manufacturer following specifications from the U.S. government testing procedures. The ratings are molded into the sidewall of the tire.

Recommended tire pressure

The recommended tire pressure for your vehicle under normal driving conditions. You will find the recommendation on the Tire and Loading Information placard on the B-pillar on the driver's side of your vehicle. The recommended tire pressure provides the best balance between handling characteristics, ride comfort and wear. Supplemental information pertaining to special driving situations can be found on the tire inflation pressure label on the inside of the fuel filler flap.

Increased vehicle weight due to optional equipment

This is the combined weight of all standard and optional equipment available for the vehicle, regardless of whether it is actually installed on the vehicle or not.

Rim

This is the part of the wheel on which the tire is mounted.

GAWR (Gross Axle Weight Rating)

The GAWR is the maximum gross axle weight rating. The actual load on an axle must never exceed the gross axle weight rating. The gross axle weight rating can be found on the vehicle identification plate on the B-pillar on the driver's side.

Speed rating

The speed rating is part of the tire identification. It specifies the speed range for which the tire is approved.

GVW (Gross Vehicle Weight)

The gross vehicle weight includes the weight of the vehicle including fuel, tools, the spare wheel, accessories installed, occupants, luggage and the drawbar noseweight, if applicable. The gross vehicle weight must not exceed the gross vehicle weight rating (GVWR) as specified on the vehicle identification plate on the B-pillar on the driver's side.

GVWR (Gross Vehicle Weight Rating)

The GVWR is the maximum permitted gross weight of the fully laden vehicle (weight of the vehicle including all accessories, occupants, fuel, luggage and the drawbar noseweight if applicable). The gross vehicle weight rating is specified on the vehicle identification plate on the B-pillar on the driver's side.

Maximum loaded vehicle weight

The maximum weight is the sum of the curb weight of the vehicle, the weight of the accessories, the total load limit and the weight of the optional equipment installed at the factory.

Kilopascal (kPa)

Metric unit for tire pressure. 6.9 kPa is the equivalent of 1 psi. Another unit for tire pressure is bar. There are 100 kilopascals (kPa) to 1 bar.

Load index

In addition to the load-bearing index, the load index may also be imprinted on the sidewall of the tire. This specifies the load-bearing capacity more precisely.

Curb weight

The weight of a vehicle with standard equipment including the maximum capacity of fuel, oil and coolant. It also includes the air-conditioning system and optional equipment if these are installed in the vehicle, but does not include passengers or luggage.

Maximum load rating

The maximum load rating in kilograms or pounds is the maximum weight for which a tire is approved.

Maximum permissible tire pressure

Maximum permissible tire pressure for one tire.

Maximum load on one tire

Maximum load on one tire. This is calculated by dividing the maximum axle load of one axle by two.

PSI (pounds per square inch)

A standard unit of measure for tire pressure.

Aspect ratio

Relationship between tire height and tire width in percent.

Tire pressure

This is pressure inside the tire applying an outward force to each square inch of the tire's surface. The tire pressure is specified in pounds per square inch (psi), in kilopascal (kPa) or in bar. The tire pressure should only be corrected when the tires are cold. For this, the vehicle must have been stationary for at least three hours or not have traveled more than 1.6 km (1 mile) in this time.

Tire pressure of cold tires

The tires are cold:

- if the vehicle has been parked without direct sunlight on the tires for at least three hours and
- if the vehicle has not been driven more than 1 mile (1.6 km)

Tread

The part of the tire that comes into contact with the road.

Bead

The tire bead ensures that the tire sits securely on the wheel. There are several steel wires in the bead to prevent the tire from coming loose from the wheel rim.

Sidewall

The part of the tire between the tread and the bead.

Weight of optional extras

The combined weight of those optional extras that weigh more than the replaced standard part and more than 2.3 kilograms (5 lbs). These optional extras, such as high-performance brakes, level control, a roof rack or a high-voltage battery, are not included in the curb weight and the weight of the accessories.

TIN (Tire Identification Number)

This is a unique identifier which can be used by a tire manufacturer to identify tires, for example for a product recall, and thus identify the purchasers. The TIN is made up of the manufacturer's identity code, tire size, tire type code and the manufacturing date.

Load bearing index

The load bearing index (also load index) is a code that contains the maximum load bearing capacity of a tire.

Traction

Traction is the result of friction between the tires and the road surface.

Treadwear indicators

Narrow bars (tread wear bars) that are distributed over the tire tread. If the tire tread is level with the bars, the wear limit of $\frac{1}{16}$ in (1.6 mm) has been reached.

Occupant distribution

The distribution of occupants in a vehicle at their designated seating positions.

Total load limit

Rated cargo and luggage load plus 68 kilograms (150 lbs) times the vehicle's designated seating capacity.

Changing a wheel

Flat tire

The "Breakdown assistance" section (▷ page 229) contains information and notes on how to deal with a flat tire. It also provides instructions on changing a wheel or mounting the spare wheel/emergency spare wheel.

Rotating the wheels

WARNING

Interchanging the front and rear wheels may severely impair the driving characteristics if the wheels or tires have different dimensions. The wheel brakes or suspension components may also be damaged. There is a risk of accident.

Rotate front and rear wheels only if the wheels and tires are of the same dimensions.

! On vehicles equipped with a tire pressure monitor, electronic components are located in the wheel.

Tire-mounting tools should not be used near the valve. This could damage the electronic components.

Only have tires changed at a qualified specialist workshop.

The wear patterns on the front and rear tires differ, depending on the operating conditions. Rotate the wheels before a clear wear pattern has formed on the tires. Front tires typically wear more on the shoulders and the rear tires in the center.

If your vehicle's tire configuration allows, you can rotate the wheels according to the intervals in the tire manufacturer's warranty book in your vehicle documents. If this is not

available, the tires should then be replaced every 3000 to 6000 miles (5000 to 10,000 km), or earlier if the tire wear requires this. Do not change the direction of wheel rotation.

Clean the contact surfaces of the wheel and the brake disc thoroughly every time a wheel is rotated. Check the tire pressures.

Information on changing tires and mounting the spare wheel (▷ page 232).

Direction of rotation

Tires with a specified direction of rotation have additional benefits, e.g. if there is a risk of hydroplaning. You will only gain these benefits if the correct direction of rotation is maintained.

An arrow on the sidewall of the tire indicates its correct direction of rotation.

You may mount a spare wheel/emergency spare wheel against the direction of rotation. Observe the time restriction on use as well as the speed limitation specified on the spare wheel/emergency spare wheel.

Storing wheels

Store wheels that are not being used in a cool, dry and preferably dark place. Protect the tires from oil, grease, gasoline and diesel.

Cleaning the wheels

WARNING

Do not use power washers with circular-jet nozzles (dirt grinders) to clean your vehicle, in particular the tires. You could otherwise damage the tires and cause an accident.

Wheel and tire combinations

Points to remember

! For safety reasons, Mercedes-Benz recommends that you only use Tires and wheels which have been approved by Mercedes-Benz specifically for your vehicle.

These tires have been specially adapted for use with the control systems, such as ABS or ESP[®], and are marked as follows:

- MO = Mercedes-Benz Original
- MOE = Mercedes-Benz Original Extended (tires featuring run-flat characteristics)
- MO1 = Mercedes-Benz Original (only certain AMG tires)

Mercedes-Benz Original Extended tires may only be used on wheels that have been specifically approved by Mercedes-Benz.

Only use tires, wheels or accessories tested and approved by Mercedes-Benz. Certain characteristics, e.g. handling, vehicle noise emissions or fuel consumption, may otherwise be adversely affected. In addition, when driving with a load, tire dimension variations could cause the tires to come into contact with the bodywork and axle components. This could result in damage to the tires or the vehicle. Mercedes-Benz accepts no liability for damage resulting from the use of tires, wheels or accessories other than those tested and approved.

Further information about tires, wheels and approved combinations can be obtained from any authorized Mercedes-Benz Center.

i The Tire and Load Information placard with the recommended tire pressures is on the B-pillar on the driver's side. Further information about driving at high speeds or driving with vehicle loads that are lighter than the maximum vehicle load can be found in the tire pressure table on the inside of the fuel filler flap. Check tire

pressures regularly, and only when the tires are cold. Comply with the maintenance recommendations of the tire manufacturer. These are located in the vehicle document wallet.

Further information on recommended tire pressures as well as tire pressures for specific driving situations, see (▷ page 251).

i Notes on the vehicle equipment – always equip the vehicle with:

- tires of the same size on a given axle (left/right)
- with the same type of tires on all wheels at a given time (summer tires, winter tires)

i The following pages contain information on approved wheel rims and tire sizes for equipping your vehicle with winter tires. Winter tires are not available at the factory as standard equipment or optional extras. If you wish to equip your vehicle with approved winter tires, you will also require, in certain circumstances, wheel rims of an appropriate size, as the sizes of approved winter tires can deviate from those of standard tires. This is dependent on the model and the equipment installed at the factory.

The tires and wheel rims, as well as further information, can be obtained at a qualified specialist workshop.

Tires

Summer tires

Front axle	
Summer tires	265/35 ZR19 (98Y) XL
Light alloy rim	9.5J x 19 H2 ET 60 or 9.5J x 19 H2 ET 59
Rear axle	
Summer tires ¹⁴	295/30 ZR20 (101Y) XL
Light alloy rim	11J x 20 H2 ET 68

Winter tires, variant 1

Front axle	
Winter tires	265/35 R19 98W XL M+S
Light alloy rim	9.5J x 19 H2 ET 60 or 9.5J x 19 H2 ET 59
Rear axle	
Winter tires ¹⁴	295/30 R20 101W XL M+S
Light alloy rim	11J x 20 H2 ET 68

Winter tires, variant 2

Front and rear axles	
Winter tires	255/35 R19 96V XL M+S
Light alloy rim	9.5J x 19 H2 ET 59

¹⁴ Snow chains not permitted.

Useful information	274
Information regarding technical data	274
Genuine Mercedes-Benz parts	274
Warranty	275
Identification plates	275
Service products and filling capacities	276
Vehicle data	282

Useful information

- i** This Operator's Manual describes all models and all standard and optional equipment of your vehicle available at the time of publication of the Operator's Manual. Country-specific differences are possible. Please note that your vehicle may not be equipped with all features described. This also applies to safety-related systems and functions.
- i** Please read the information on qualified specialist workshops (▷ page 22).

Information regarding technical data

You can find technical data on the Internet at: <http://www.mercedes-benz.com>

- i** The data stated here specifically refers to a vehicle with standard equipment. Consult an authorized Mercedes-Benz Center for the data for all vehicle variants and trim levels.

Genuine Mercedes-Benz parts

WARNING

Driving safety may be impaired if non-approved parts, tires and wheels or safety-relevant accessories are used.

This could lead to malfunctions in safety-relevant systems, e.g. the brake system. This could cause you to lose control of your vehicle and cause an accident.

For this reason, Mercedes-Benz recommends that you use genuine Mercedes-Benz parts or parts of equal quality. Only use tires, wheels and accessories that have been specifically approved for your vehicle.

Environmental note

Daimler AG also supplies reconditioned major assemblies and parts which are of the same

quality as new parts. They are covered by the same Limited Warranty entitlements as new parts.

- !** Air bags and Emergency Tensioning Devices, as well as control units and sensors for these restraint systems may be installed in the following areas of your vehicle:

- doors
- door pillars
- door sills
- seats
- dashboard
- instrument cluster
- center console

Do not install accessories such as audio systems in these areas. Do not carry out repairs or welding. You could impair the operating efficiency of the restraint systems.

Have aftermarket accessories installed at a qualified specialist workshop. Mercedes-Benz recommends that you use an authorized Mercedes-Benz Center for this purpose.

Genuine Mercedes-Benz parts are subject to strict quality control. Every part has been specifically developed, manufactured or selected for and adapted to Mercedes-Benz vehicles. Only genuine Mercedes-Benz parts should therefore be used.

More than 300,000 different genuine Mercedes-Benz parts are available for Mercedes-Benz models.

All authorized Mercedes-Benz Centers maintain a supply of genuine Mercedes-Benz parts for necessary service and repair work. In addition, strategically located parts delivery centers provide quick and reliable parts service.

Always specify the vehicle identification number (VIN) (▷ page 275) and the engine number (▷ page 276) when ordering genuine Mercedes-Benz parts.

Warranty

The Service and Warranty Information booklet contains detailed information about the warranties covering your vehicle.

Your authorized Mercedes-Benz Center will exchange or repair any defective parts originally installed in the vehicle in accordance with the terms of the following warranties:

- New Vehicle Limited Warranty
- Emission System Warranty
- Emission Performance Warranty
- California, Connecticut, Maine, Massachusetts, New York, Pennsylvania, Rhode Island and Vermont Emission Control System Warranty
- State warranty enforcement laws (Lemon Laws)

Replacement parts and accessories are covered by the Mercedes-Benz Parts and Accessories warranties. You can obtain information about this from any authorized Mercedes-Benz Center.

- i** Should you lose your Service and Warranty Information booklet, have an authorized Mercedes-Benz Center arrange for a replacement. It will be mailed to you.

Identification plates

Vehicle identification plate with vehicle identification number (VIN) and paint code number



- ▶ Open the driver's door. You will see vehicle identification plate ①.

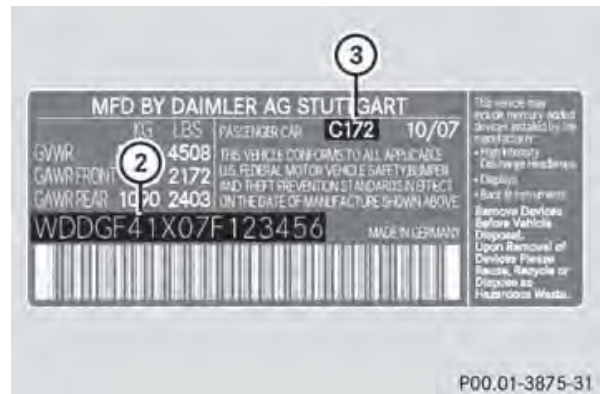

Example: vehicle identification plate (USA only)

- ② VIN
- ③ Paint code



Example: vehicle identification plate (Canada only)

- ② VIN
- ③ Paint code

- i** The data shown on the identification plate is example data. This data is different for every vehicle and can deviate from the data shown here. You can find the data applicable to your vehicle on the vehicle identification plate.

VIN



- ▶ Slide the right-hand front seat to its rearmost position.
- ▶ Fold floor covering ① upwards. You will see VIN ②.

Additionally, the vehicle identification number (VIN) can be found in the following locations:

- on the vehicle identification plate (▷ page 275)
- on the lower edge of the windshield (▷ page 276)

Engine number

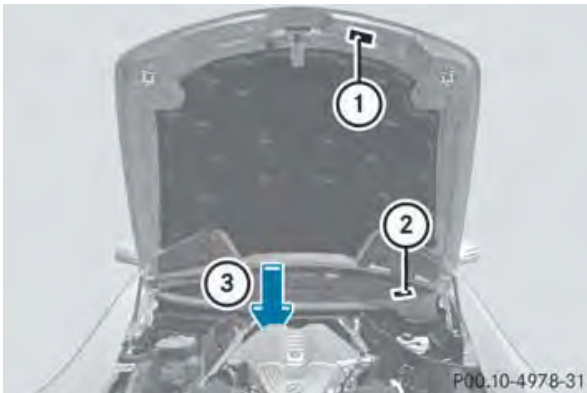

- ① Emission control information plate, including the certification of both federal and Californian emissions standards
- ② VIN (on the lower edge of the windshield)
- ③ Engine number (stamped into the crankcase)

Service products and filling capacities

Important safety notes

⚠ WARNING

Comply with all valid regulations with respect to handling, storing and disposing of service fluids. Otherwise, you could endanger persons or the environment.

Keep service fluids out of the reach of children.

For health reasons, you should prevent service fluids from coming into direct contact with your skin or clothing.

If a service fluid is swallowed, contact a physician immediately.

Service products include the following:

- Fuels
- Lubricants (e.g. engine oil, transmission oil)
- Coolant
- Brake fluid
- Windshield washer fluid
- Climate control system refrigerant

Components and service products must be matched. You should therefore only use products that have been tested and approved by Mercedes-Benz.

Information on tested and approved products can be obtained at an authorized Mercedes-Benz Center or on the Internet at <http://bevo.mercedes-benz.com>.

You can recognize service products approved by Mercedes-Benz by the following inscription on the containers:

- MB-Freigabe (e.g. MB-Freigabe 229.51)
- MB Approval (e.g. MB Approval 229.51)

Other designations or recommendations indicate a level of quality or a specification in accordance with an MB Sheet number (e.g. MB 229.5). They have not necessarily been approved by Mercedes-Benz.

Filling capacities		
	Capacity	Fuel, coolant, lubricants, etc.
Engine oil and filter	8.43 US qt (7.98 l)	Approved engine oils
AMG SPEEDSHIFT DCT 7-speed sports transmission, hydraulic chamber	7.4 US qt (7.0 l) + 0.85 US qt (0.8 l) for oil cooler and hose lines at the first filling	Shell DCT F.3
AMG SPEEDSHIFT DCT 7-speed sports transmission, gear set, drive set and differential chamber	3.06 US qt (2.9 l) + 0.87 US qt (0.82 l) for oil cooler and hose lines at the first filling	Shell GL.5
Power steering	1.26 US qt (1.2 l)	Chevron Texaco CHF 9109
Brake system	Approximately 0.53 US qt (0.5 l)	MB Brake Fluid (DOT 4+)
Cooling system	Approximately 11.6 US qt (11.0 l)	MB 325.0 corrosion inhibitor/antifreeze agent
Tank capacity	22.5 US gal (85.0 l)	Premium-grade unleaded gasoline (at least 91 octane, average value between 96 RON/86 MON)
Reserve	Approximately 3.7 US gal (14.0 l)	
Automatic climate control	–	Refrigerant R134a and special PAG lubricant (never R 12)
Windshield/headlamp cleaning system	6.3 US qt (6.0 l)	MB windshield washer concentrate ¹⁵ (▷ page 281) Mixing ratio for washer fluid (▷ page 281)

Fuel

Important safety notes

WARNING

Fuel is highly flammable. If you handle fuel incorrectly, there is a risk of fire and explosion.

You must avoid fire, open flames, creating sparks and smoking. Switch off the engine and, if applicable, the auxiliary heating before refueling.

WARNING

Fuel is poisonous and hazardous to health. There is a risk of injury.

¹⁵ Mixed with water or premixed washer fluid with antifreeze protection.

You must make sure that fuel does not come into contact with your skin, eyes or clothing and that it is not swallowed. Do not inhale fuel vapors. Keep fuel away from children.

If you or others come into contact with fuel, observe the following:

- Wash away fuel from skin immediately using soap and water.
- If fuel comes into contact with your eyes, immediately rinse them thoroughly with clean water. Seek medical assistance without delay.
- If fuel is swallowed, seek medical assistance without delay. Do not induce vomiting.
- Immediately change out of clothing which has come into contact with fuel.

Tank capacity

Total capacity	85 l
Of which reserve	Approximately 14 l

Petrol (EN 228, E DIN 51626-1)

Fuel grade

! Do not use diesel to refuel vehicles with a gasoline engine. Do not switch on the ignition if you accidentally refuel with the wrong fuel. Otherwise, the fuel will enter the fuel system. Even small amounts of the wrong fuel could result in damage to the fuel system and the engine. The repair costs are high. Notify a qualified specialist workshop and have the fuel tank and fuel lines drained completely.

! You should only refuel with unleaded premium-grade gasoline as this avoids damaging the catalytic converter. If engine running problems are apparent, have the cause checked immediately and repaired. Excess unburned fuel can otherwise enter the catalytic converter, leading to overheating and possibly causing a fire.

! To ensure the longevity and full performance of the engine, only premium-grade unleaded gasoline may be used. If there is no premium-grade unleaded gasoline available and regular unleaded gasoline must be used, please observe the following precautions:

- only fill the fuel tank to half full with regular unleaded gasoline and fill the rest with premium-grade unleaded gasoline as soon as possible.
- do not drive at the maximum speed.
- avoid sudden acceleration.
- if the vehicle is carrying a light load, e.g. two passengers without luggage, do not allow the engine to rev above 3000 rpm.
- if the vehicle is fully loaded or is being operated in mountainous terrain, do not depress the accelerator pedal further than $\frac{2}{3}$ of the pedal travel.

Only refuel using premium-grade unleaded gasoline with a minimum octane rating of 91. Reformulated Gasoline (RFG) and/or unleaded gasoline with additives can be used. The concentration of additives in the fuel, however, must not exceed 10%, e.g.:

- Ethanol
- TAME
- ETBE
- IPA
- TBA

For MTBE, the concentration should not exceed 15%.

The concentration of methanol in gasoline, including other additives, must not exceed 3%.

Using mixtures of methanol and ethanol is not permitted. Gasohol, a mixture of 10% ethanol and 90% unleaded gasoline, may be used.

All of these blends must fulfill the fuel requirements, e.g.:

- knock resistance
- boiling point
- vapor pressure

You will usually find information about the fuel grade on the pump. If you cannot find the label on the pump, ask the staff for assistance.

- i** For further information, consult an authorized Mercedes-Benz Center or on the Internet at <http://www.mbusa.com> (USA only).

Information on refueling (▷ page 125).

Additives

- !** Operating the engine with fuel additives can increase wear and tear to the fuel system high-pressure pump and lead to contamination of the entire fuel system. The repair costs are high. This does not include additives for the removal and prevention of residue buildup. Gasoline must only be mixed with additives recommended by Mercedes-Benz. More information about recommended additives can be obtained from any authorized Mercedes-Benz Center.

One of the main problems of poor fuel quality is the forming of deposits that are created during the gasoline combustion process. Mercedes-Benz recommends that you use branded fuels that have additives.

If you use fuels without these additives over a longer period of time, carbon deposits may build up. These deposits form at the inlet valves and in the combustion chamber in particular.

This could lead to engine problems, e.g.:

- longer engine warm-up phase
- uneven idle
- engine noise

- misfiring
- loss of power

Carbon deposits may form if the availability of gasoline with relevant additives is insufficient (in certain regions). In this case, Mercedes-Benz recommends additives approved for use in Mercedes-Benz vehicles; see <http://bevo.mercedes-benz.com>.

For a list of approved products, consult an authorized Mercedes-Benz Center. Comply with the instructions for use on the product label.

Do not mix other fuel additives with fuel. This causes unnecessary costs and could damage the engine.

Engine oil

General notes

- !** Never use engine oil or an oil filter of a specification other than is necessary to fulfill the prescribed service intervals. Do not change the engine oil or oil filter in order to achieve longer replacement intervals than those prescribed. You could otherwise cause engine damage or damage to the exhaust gas aftertreatment.

Follow the instructions in the service interval display regarding the oil change. Otherwise, you may damage the engine and the exhaust gas aftertreatment.

The engine oils are matched to the performance of Mercedes-Benz engines and service intervals. You should therefore only use engine oils and oil filters that are approved for vehicles with maintenance systems.

For a list of approved engine oils and oil filters, consult an authorized Mercedes-Benz Center. Or visit the website <http://bevo.mercedes-benz.com>.

The table shows which engine oils have been approved for your vehicle.

MB sheet number 229.5¹⁶

i MB approval is indicated on the oil containers.

Filling capacities

The following values refer to an oil change including the oil filter.

Engine with oil filter 10.0 US qt (9.5 l)

Additives

! Do not use any additives in the engine oil. This could damage the engine.

Engine oil viscosity

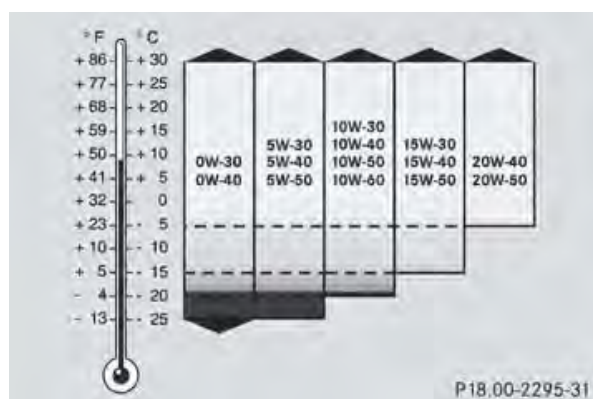

Viscosity describes the flow characteristics of a fluid. If an engine oil has a high viscosity, this means that it is thick; a low viscosity means that it is thin.

Select an engine oil with an SAE (viscosity) classification suitable for the prevailing outside temperatures. The table shows you which SAE classifications are to be used. The low-temperature characteristics of engine oils can deteriorate significantly, e.g. as a result of aging, soot and fuel deposits. It is therefore strongly recommended that you carry out regular oil changes using an approved engine oil with the appropriate SAE classification.

Refrigerant of the air-conditioning system

The automatic climate control is filled with R134a refrigerant and a special PAG lubricant.

! Never use refrigerant R 12 (CFC) or mineral lubricants. Otherwise, you could damage the air-conditioning system.

Brake fluid

! WARNING

Over a period of time, the brake fluid absorbs moisture from the air; this lowers its boiling point.

If the boiling point of the brake fluid is too low, vapor pockets may form in the brake system when the brakes are applied hard (e.g. when driving downhill). This would impair braking efficiency.

You should have the brake fluid renewed at regular intervals. The brake fluid change intervals can be found in the Maintenance Booklet.

Only use brake fluid approved by Mercedes-Benz according to MB Approval 331.0.

Information about approved brake fluid can be obtained at any qualified specialist workshop or on the Internet at <http://bevo.mercedes-benz.com>.

i Have the brake fluid renewed regularly at a qualified specialist workshop.

Coolant

Important safety notes

! WARNING

Antifreeze is highly flammable. Fire, open flames and smoking are prohibited when handling antifreeze.

¹⁶ Restriction: only use SAE 0W-40/SAE 5W-40 engine oils.

If antifreeze comes into contact with hot engine parts, it may ignite and you could burn yourself. Do not spill any antifreeze on hot engine parts.

- ❗ Only add coolant that has been premixed with the desired antifreeze protection. You could otherwise damage the engine.

Further information on coolants can be found in the Mercedes-Benz Specifications for Service Products, MB Specifications for Service Products 310.1, e.g. on the Internet at <http://bevo.mercedes-benz.com>. Or contact a qualified specialist workshop.

- ❗ Always use a suitable coolant mixture, even in countries where high temperatures prevail.

Otherwise, the engine cooling system is not sufficiently protected from corrosion and overheating.

The coolant is a mixture of water and antifreeze/corrosion inhibitor. It performs the following tasks:

- corrosion protection
- antifreeze protection
- raising the boiling point

If the coolant has antifreeze protection down to -35 °F (-37 °C), the boiling point of the coolant during operation is approximately 266 °F (130 °C).

The antifreeze/corrosion inhibitor concentration in the engine cooling system should:

- be at least 50%. This will protect the engine cooling system against freezing down to approximately -35 °F (-37 °C).
- not exceed 55% (antifreeze protection down to -49 °F [-45 °C]). Otherwise, heat will not be dissipated as effectively.

If the vehicle has lost coolant, add equal amounts of water and antifreeze/corrosion inhibitor. Mercedes-Benz recommends an antifreeze/corrosion inhibitor concentrate in

accordance with MB Specifications for Service Products 310.1.

The coolant is checked with every maintenance interval at a qualified specialist workshop.

- ❗ When the vehicle is first delivered, it is filled with a coolant mixture that ensures adequate antifreeze and corrosion protection.

Windshield/headlamp cleaning system

Important safety notes

WARNING

Windshield washer concentrate is highly flammable. If it comes into contact with hot engine components or the exhaust system it could ignite. There is a risk of fire and injury. Make sure that no windshield washer concentrate is spilled next to the filler neck.

- ❗ Only use washer fluid that is suitable for plastic lamp lenses, e.g. MB SummerFit or MB WinterFit. Unsuitable washer fluid could damage the plastic lenses of the headlamps.

- ❗ Do not add distilled or de-ionized water to the washer fluid container. Otherwise, the level sensor may be damaged.

- ❗ Only MB SummerFit and MB WinterFit washer fluid should be mixed together. The spray nozzles may otherwise become blocked.

At temperatures above freezing:

- ▶ Fill the washer fluid reservoir with a mixture of water and windshield washer fluid, e.g. MB SummerFit.

Add 1 part MB SummerFit to 100 parts water.

At temperatures below freezing:

- Fill the washer fluid reservoir with a mixture of water and windshield washer fluid, e.g. MB WinterFit.

Adapt the mixing ratio to the outside temperature.

- Down to 14 °F (-10 °C): mix 1 part MB WinterFit to 2 parts water.
- Down to -4 °F (-20 °C): mix 1 part MB WinterFit to 1 part water.
- Down to -20.2 °F (-29 °C): mix 2 parts MB WinterFit to 1 part water.

- i** Add windshield washer fluid, e.g. MB SummerFit or MB WinterFit, to the washer fluid all year round.

Filling capacities

Model	Capacity
All models	7.4 US qt (7.0 l)

Vehicle data

General notes

Please note that for the specified vehicle data:

- The heights specified may vary as a result of:
 - Tires
 - Load
 - Condition of the suspension
 - Optional equipment
- The vehicle length specified includes the front license plate adapter.

Vehicle data, Coupe

The data stated here specifically refers to a vehicle with standard equipment. Consult an authorized Mercedes-Benz Center for the data for all vehicle variants and trim levels.

Vehicle dimensions

Vehicle length	182.7 in (4640 mm)
Vehicle width including exterior mirrors	81.7 in (2075 mm)
Vehicle height	49.7 in (1262 mm)
Wheelbase	105.5 in (2680 mm)
Front track	66.2 in (1682 mm)
Rear track	65.0 in (1651 mm)
Ground clearance	3.9 in (99 mm)
Turning circle	39.0 ft (11.9 m)

Vehicle weight

Maximum trunk load	137 lb (62 kg)
---------------------------	----------------

Vehicle data, Roadster

The data stated here specifically refers to a vehicle with standard equipment. Consult an authorized Mercedes-Benz Center for the data for all vehicle variants and trim levels.

Vehicle dimensions

Vehicle length	182.7 in (4640 mm)
Vehicle width including exterior mirrors	81.7 in (2075 mm)
Vehicle height	49.6 in (1261 mm)
Wheelbase	105.5 in (2680 mm)
Front track	66.2 in (1682 mm)
Rear track	65.0 in (1651 mm)
Ground clearance	3.9 in (99 mm)
Turning circle	39.0 ft (11.9 m)

Vehicle weight	
Maximum trunk load	137 lb (62 kg)

Opening dimensions of the trunk lid



Coupe

- ① Opening height: 63.4 in (1,610 mm) (rear spoiler retracted)
Opening height: 66.0 in (1,677 mm) (rear spoiler extended)



Roadster

- ① Opening height: 67.4 in (1,713 mm) (rear spoiler retracted)
Opening height: 68.2 in (1,732 mm) (rear spoiler extended)
- i** The values specified may differ from the actual values depending on the tires, load, optional equipment and condition of the suspension.

Opening dimensions, gullwing doors



- ① Range of movement exceeding vehicle width: 14.3 in (362 mm)
- ② Opening height: 73.7 in (1,873 mm) (exterior mirrors folded in)
Opening height: 76.6 in (1,946 mm) (exterior mirrors folded in)
- i** The values specified may differ from the actual values depending on the tires, load, optional equipment and condition of the suspension.



1975841381

Order no. 6515 4878 13 Part no. 197 584 13 81 Edition A 2013