



CLA

Operator's Manual



1175844003

Order no. P117 0017 13 Part no. 117 584 40 03 Edition A 2017

CLA Operator's Manual



Mercedes-Benz

Symbols

In this Operator's Manual you will find the following symbols:

WARNING

Warning notes make you aware of dangers which could pose a threat to your health or life, or to the health and life of others.

Environmental note

Environmental notes provide you with information on environmentally aware actions or disposal.

 Notes on material damage alert you to dangers that could lead to damage to your vehicle.

 Practical tips or further information that could be helpful to you.

- ▶ This symbol indicates an instruction that must be followed.
 - ▶ Several of these symbols in succession indicate an instruction with several steps.
 - (▷ This symbol tells you where you can find more information about a topic.
- Dis-**
play This text indicates a message on the multifunction display/multimedia display.

Publication details

Internet

Further information about Mercedes-Benz vehicles and about Daimler AG can be found on the following websites:

<http://www.mbusa.com> (USA only)

<http://www.mercedes-benz.ca> (Canada only)

Editorial office

©Daimler AG: not to be reprinted, translated or otherwise reproduced, in whole or in part, without written permission from Daimler AG.

Vehicle manufacturer

Daimler AG
Mercedesstraße 137
70327 Stuttgart
Germany

Welcome to the world of Mercedes-Benz

We urge you to read this Operator's Manual carefully and familiarize yourself with the vehicle before driving. For your own safety and a longer vehicle life, follow the instructions and warning notices in this Operator's Manual. Ignoring them could result in damage to the vehicle or personal injury to you or others.

Vehicle damage caused by failure to follow instructions is not covered by the Mercedes-Benz Limited Warranty.

The equipment or product designation of your vehicle may vary depending on:

- Model
- Order
- Country specification
- Availability

Mercedes-Benz therefore reserves the right to introduce changes in the following areas:

- Design
- Equipment
- Technical features

The equipment in your vehicle may therefore differ from that shown in the descriptions and illustrations.

The following are integral components of the vehicle:

- Printed Operator's Manual
- Maintenance Booklet
- Equipment-dependent supplements

Keep these documents in the vehicle at all times. If you sell the vehicle, always pass all documents on to the new owner.

You can also use the Mercedes-Benz Guides App:

Your Operator's Manual:

Digital form inside the vehicle

The Digital Operator's Manual provides comprehensive and specifically adapted information on your vehicle's equipment and multimedia system. It contains informative animations, individual language settings and an intuitive search function.

Booklet inside the vehicle

In addition to this manual and the aforementioned digital media, you also have the option to obtain a comprehensive printed version of the Supplement for your multi-

media system from your authorized Mercedes-Benz Center.

Digital form via the Internet

The Operator's Manual on the Internet provides easy access to all information regarding your vehicle and multimedia system. It also provides helpful animations, interesting background information and a wide array of search options.

Digital form as an App

Using the Mercedes-Benz Guides App, you can view all the information on your vehicle and multimedia system via mobile Internet or download it independently of network access. Available for smartphones or tablets.

You can also use the Mercedes-Benz Guides App:



Apple® iOS



Android™

Please note that the Mercedes-Benz Guides App may not yet be available in your country.

Mercedes-Benz USA, LLC
Mercedes-Benz Canada, Inc.
A Daimler Company

Index	4	Mirrors	95
Digital Operator's Manual	22	Memory function	97
Introduction	22	Lights and windshield wipers	99
Operation	22	Exterior lighting	99
Introduction	23	Interior lighting	102
Protecting the environment	23	Replacing bulbs	103
Genuine Mercedes-Benz parts	23	Windshield wipers	106
Operator's Manual	24	Climate control	109
Service and vehicle operation	24	Overview of climate control systems ...	109
Operating safety	26	Operating the climate control systems	114
QR codes for the rescue card	28	Air vents	119
Data stored in the vehicle	28	Driving and parking	120
Information on copyright	30	Notes on breaking-in a new vehicle	120
At a glance	31	Driving	120
Cockpit	31	DYNAMIC SELECT button (all vehicles except Mercedes-AMG vehicles)	127
Instrument cluster	32	DYNAMIC SELECT controller (Mercedes-AMG vehicles)	128
Multifunction steering wheel	33	Automatic transmission	129
Center console	34	Refueling	137
Door control panel	37	Parking	140
Overhead control panel	38	Driving tips	143
Safety	39	Driving systems	148
Panic alarm	39	On-board computer and displays	174
Occupant safety	39	Important safety notes	174
Children in the vehicle	53	Displays and operation	174
Pets in the vehicle	59	Menus and submenus	177
Driving safety systems	60	Display messages	188
Protection against theft	67	Warning and indicator lamps in the instrument cluster	216
Opening and closing	69	Multimedia system	227
SmartKey	69	General notes	227
Doors	75	Important safety notes	227
Trunk	77	Function restrictions	227
Side windows	80	Operating system	228
Panorama roof with power tilt/sliding panel	84	Stowage and features	233
Seats, steering wheel and mirrors	89	Loading guidelines	233
Correct driver's seat position	89	Stowage areas	233
Seats	89		
Steering wheel	94		

Features 238

Maintenance and care 254

Engine compartment 254

ASSYST PLUS 258

Care 259

Breakdown assistance 266

Where will I find...? 266

Flat tire 266

Battery (vehicle) 271

Jump-starting 273

Towing and tow-starting 276

Fuses 279

Wheels and tires 282

Important safety notes 282

Operation 282

Winter operation 284

Tire pressure 285

Loading the vehicle 292

All about wheels and tires 295

Changing a wheel 301

Wheel and tire combinations 306

Technical data 307

Information regarding technical data ... 307

Vehicle electronics 307

Identification plates 308

Service products and filling capaci-

ties 309

Vehicle data 314

1, 2, 3 ...

4ETS (Electronic Traction System)

see ETS/4ETS (Electronic Traction System)

4MATIC

Display message 213

4MATIC (permanent four-wheel drive)

..... 159

12 V socket

see Sockets

A

ABS (Anti-lock Braking System)

Display message 189

Function/notes 60

Important safety notes 60

Warning lamp 218

Accident

Automatic measures after an accident 53

Activating media mode

General notes 232

Activating/deactivating cooling

with air dehumidification 114

Active Brake Assist

Activating or deactivating 182

Display message 194

Function/notes 61

ADAPTIVE BRAKE 66

Adaptive Damping System

Function/notes 159

Adaptive Highbeam Assist

Display message 202

Function/notes 101

Switching on/off 102

Additional speedometer 184

Additives (engine oil) 312

Address book

see also Digital Operator's Manual 227

Adjusting the volume

Audio 20 228

COMAND 228

Air bags

Deployment 51

Display message 197

Front air bag (driver, front

passenger) 45

Important safety notes 44

Introduction 44

Knee bag 45

Occupant Classification System

(OCS) 46

PASSENGER AIR BAG indicator

lamps 40

Side impact air bag 45

Window curtain air bag 46

Air vents

Important safety notes 119

Rear 119

Setting the center air vents 119

Setting the side air vents 119

Air-conditioning system

see Climate control

Alarm

ATA (Anti-Theft Alarm system) 67

Switching off (ATA) 67

Switching the function on/off

(ATA) 67

Alarm system

see ATA (Anti-Theft Alarm system)

AMG

Adaptive sport suspension system 158

Performance Seat 93

AMG adaptive sport suspension system

General Information 158

AMG menu (on-board computer) 185

AMG Performance exhaust system 126

Anti-lock braking system

see ABS (Anti-lock Braking System)

Anti-Theft Alarm system

see ATA (Anti-Theft Alarm system)

Ashtray 240

Assistance display (on-board computer) 182

Assistance menu (on-board computer) 182

ASSYST PLUS

Displaying a service message 258

Driving abroad 259

- Hiding a service message 258
 - Information about Service 258
 - Resetting the service interval display 258
 - Service message 258
 - Special service requirements 258
 - ATA (Anti-Theft Alarm system)**
 - Activating/deactivating 67
 - Function 67
 - Switching off the alarm 67
 - ATTENTION ASSIST**
 - Activating/deactivating 183
 - Display message 205
 - Function/notes 169
 - Audio 20**
 - Switching on/off 228
 - Audio menu (on-board computer)** 180
 - Audio system**
 - see separate operating instructions
 - Authorized Mercedes-Benz Center**
 - see Qualified specialist workshop
 - Authorized workshop**
 - see Qualified specialist workshop
 - AUTO lights**
 - Display message 201
 - see Lights
 - Automatic car wash (care)** 259
 - Automatic engine start (ECO start/stop function)** 125
 - Automatic engine switch-off (ECO start/stop function)** 125
 - Automatic headlamp mode** 99
 - Automatic transmission**
 - Accelerator pedal position 132
 - Changing gear 132
 - DIRECT SELECT lever 129
 - Drive program 133
 - Drive program display 129
 - Driving tips 132
 - DYNAMIC SELECT button (all vehicles except Mercedes-AMG vehicles) 127
 - DYNAMIC SELECT controller (Mercedes-AMG vehicles) 128
 - Emergency running mode 137
 - Engaging drive position 131
 - Engaging neutral 130
 - Engaging park position (Mercedes-AMG vehicles) 131
 - Engaging park position automatically 130
 - Engaging reverse gear 130
 - Engaging the park position 129
 - Holding the vehicle stationary on uphill gradients 133
 - Kickdown 133
 - Manual shifting 135
 - Oil temperature (on-board computer, Mercedes-AMG vehicles) 185
 - Overview 129
 - Problem (malfunction) 137
 - Pulling away 124
 - Selector lever 131
 - Starting the engine 123
 - Steering wheel paddle shifters 135
 - Transmission position display 131
 - Transmission position display (DIRECT SELECT lever) 129
 - Transmission positions 132
 - Automatic transmission emergency mode** 137
- B
- Back button** 228
 - Backup lamp**
 - Display message 200
 - BAS (Brake Assist System)** 60
 - Battery (SmartKey)**
 - Checking 72
 - Important safety notes 72
 - Replacing 72
 - Battery (vehicle)**
 - Charging 273
 - Display message 203
 - Important safety notes 271
 - Jump starting 273
 - Belt**
 - see Seat belts
 - Blind Spot Assist**
 - Activating/deactivating (on-board computer) 183
 - Display message 206
 - Notes/function 171

- Bluetooth®**
Connecting a different mobile phone 232
- Bluetooth®**
Searching for a mobile phone 231
see also Digital Operator's Manual 227
Telephony 230
- Brake Assist**
see BAS (Brake Assist System)
- Brake fluid**
Display message 194
Notes 312
- Brake force distribution**
see EBD (electronic brake force distribution)
- Brake lamp**
Replacing bulbs 105
- Brake lamps**
Display message 199
- Brakes**
ABS 60
BAS 60
Brake fluid (notes) 312
Braking assistance appropriate to the situation 62
Display message 189
EBD 66
Hill start assist 124
HOLD function 156
Important safety notes 145
Maintenance 146
Parking brake 141
Riding tips 145
Warning lamp 217
- Braking assistance appropriate to the situation**
Function/notes 62
- Breakdown**
Where will I find...? 266
see Flat tire
see Tow-starting
see Towing away
- Buttons on the steering wheel** 175
- C**
- California**
Important notice for retail customers and lessees 24
- Calling up a malfunction**
see Display messages
- Car**
see Vehicle
- Care**
Car wash 259
Carpets 265
Display 263
Exhaust pipe 263
Exterior lights 262
Gear or selector lever 264
Interior 263
Matte finish 261
Notes 259
Paint 260
Plastic trim 263
Power washer 260
Rear view camera 262
Roof lining 265
Seat belt 264
Seat cover 264
Sensors 262
Steering wheel 264
Trim pieces 264
Washing by hand 260
Wheels 261
Windows 261
Wiper blades 262
Wooden trim 264
- Cargo compartment enlargement** ... 236
- Cargo tie down rings** 237
- CD**
see also Digital Operator's Manual 227
- CD player (on-board computer)** 180
- Center console**
Lower section 35
Upper section 34
- Central locking**
Automatic locking (on-board computer) 184
Locking/unlocking (SmartKey) 69
- Change of address** 25

- Change of ownership** 25
- Child**
 - Restraint system 55
- Child seat**
 - Forward-facing restraint system 58
 - LATCH-type (ISOFIX) child seat anchors 56
 - On the front-passenger seat 57
 - Rearward-facing restraint system 58
 - Top Tether 56
- Child-proof locks**
 - Important safety notes 58
 - Rear doors 59
- Children**
 - Special seat belt retractor 54
- Cigarette lighter** 241
- Cleaning**
 - Mirror turn signal 262
- Climate control**
 - Air-conditioning system 110
 - Automatic climate control (dual-zone) 112
 - Controlling automatically 115
 - Cooling with air dehumidification .. 114
 - Defrosting the windows 117
 - Defrosting the windshield 116
 - General notes 109
 - Indicator lamp 115
 - Information about using automatic climate control 113
 - Maximum cooling 117
 - Notes on using the air-conditioning system 111
 - Overview of systems 109
 - Problem with the rear window defroster 118
 - Problems with cooling with air dehumidification 115
 - Refrigerant 313
 - Refrigerant filling capacity 314
 - Setting the air distribution 115
 - Setting the air vents 119
 - Setting the airflow 116
 - Setting the temperature 115
 - Switching air-recirculation mode on/off 118
 - Switching on/off 114
 - Switching residual heat on/off 118
 - Switching the rear window defroster on/off 117
 - Switching the ZONE function on/off 116
- Cockpit**
 - Overview 31
- COMAND**
 - Switching on/off 228
- COMAND display**
 - Cleaning 263
- Combination switch** 100
- Compass**
 - Calibrating 252
 - Calling up 252
 - Magnetic field zone maps 252
 - Setting 252
- Connecting a USB device**
 - see also Digital Operator's Manual 227
- Consumption statistics (on-board computer)** 177
- Controller** 228
- Convenience closing feature** 82
- Convenience opening feature** 82
- Coolant (engine)**
 - Checking the level 257
 - Display message 202
 - Filling capacity 313
 - Important safety notes 312
 - Temperature (on-board computer, Mercedes-AMG vehicles) 185
 - Temperature gauge 175
 - Warning lamp 223
- Cooling**
 - see Climate control
- Copyright** 30
- Cornering light function**
 - Display message 199
- Cruise control**
 - Activation conditions 149
 - Cruise control lever 148
 - Deactivating 149
 - Display message 208
 - Driving system 148
 - Function/notes 148
 - Important safety notes 148
 - Setting a speed 149

- Storing and maintaining current speed 149
 - Cup holder**
 - Center console 239
 - Important safety notes 238
 - Rear compartment 239
 - Customer Assistance Center (CAC)** 27
 - Customer Relations Department** 27
- D**
- Dashboard**
 - see Instrument cluster
 - Data**
 - see Technical data
 - Daytime running lamps**
 - Display message 201
 - Function/notes 99
 - Switching on/off (on-board computer) 184
 - Declarations of conformity** 26
 - Diagnostics connection** 27
 - Digital Operator's Manual**
 - Help 22
 - Introduction 22
 - Digital speedometer** 178
 - DIRECT SELECT lever**
 - Automatic transmission 129
 - Display messages**
 - ASSYST PLUS 258
 - Calling up (on-board computer) 188
 - Driving systems 205
 - Engine 202
 - General notes 188
 - Hiding (on-board computer) 188
 - Lights 199
 - Safety systems 189
 - SmartKey 214
 - Tires 209
 - Vehicle 211
 - Distance Pilot DISTRONIC**
 - Activating 152
 - Calling up a speed 152
 - Cruise control lever 151
 - Display Message 207
 - Displays in the instrument cluster .. 154
 - Driving tips 155
 - Function/notes 150
 - Important safety notes 150
 - Setting a speed 153
 - Setting the specified minimum distance 153
 - Stopping 153
 - Storing a speed 152
 - Switching off 154
 - Distance recorder** 177
 - Distance warning (warning lamp)** 225
 - Distance warning function**
 - Function/notes 61
 - Warning lamp 225
 - Doors**
 - Automatic locking (on-board computer) 184
 - Automatic locking (switch) 76
 - Central locking/unlocking (SmartKey) 69
 - Control panel 37
 - Display message 214
 - Emergency locking 76
 - Emergency unlocking 76
 - Important safety notes 75
 - Opening (from inside) 75
 - Drinking and driving** 143
 - Drive program**
 - Automatic transmission 133
 - Display 131
 - Display (DIRECT SELECT lever) 129
 - SETUP (on-board computer) 186
 - Driver's door**
 - see Doors
 - Driving abroad**
 - Mercedes-Benz Service 259
 - Driving on flooded roads** 147
 - Driving safety system**
 - Active Brake Assist 61
 - Braking assistance appropriate to the situation 62
 - Driving safety systems**
 - ABS (Anti-lock Braking System) 60
 - ADAPTIVE BRAKE 66
 - BAS (Brake Assist System) 60
 - Distance warning function 61
 - EBD (electronic brake force distribution) 66

- ESP® (Electronic Stability Program) 63
 - Important safety information 60
 - Overview 60
 - STEER CONTROL 66
 - Driving system**
 - Distance Pilot DISTRONIC 150
 - Parking assist PARKTRONIC 160
 - Parking Pilot 162
 - RACE START (Mercedes-AMG vehicles) 157
 - Start-off assist 157
 - Driving systems**
 - AMG adaptive sport suspension system 158
 - ATTENTION ASSIST 169
 - Blind Spot Assist 171
 - Cruise control 148
 - Display message 205
 - HOLD function 156
 - Lane Keeping Assist 172
 - Lane Tracking package 171
 - Rear view camera 166
 - Driving tips**
 - Automatic transmission 132
 - Brakes 145
 - Break-in period 120
 - Checking brake lining thickness 146
 - Distance Pilot DISTRONIC 155
 - Downhill gradient 145
 - Drinking and driving 143
 - Driving in winter 147
 - Driving on flooded roads 147
 - Driving on wet roads 147
 - Exhaust check 143
 - Fuel 143
 - General 143
 - Hydroplaning 147
 - Icy road surfaces 147
 - Limited braking efficiency on salted roads 146
 - Snow chains 285
 - The first 1000 miles (1500 km) 120
 - Wet road surface 145
 - DVD video**
 - Operating (on-board computer) 180
 - see also Digital Operator's Manual 227
 - DYNAMIC SELECT button**
 - Climate control (3-zone automatic climate control) 114
 - Climate control (air-conditioning system) 111
 - DYNAMIC SELECT button (all vehicles except Mercedes-AMG vehicles)** 127
 - DYNAMIC SELECT controller (Mercedes-AMG vehicles)** 128
- E**
- EBD (electronic brake force distribution)**
 - Display message 191
 - Function/notes 66
 - ECO display**
 - Function/notes 144
 - On-board computer 177
 - ECO start/stop function**
 - Automatic engine start 125
 - Automatic engine switch-off 125
 - Deactivating/activating 126
 - General information 125
 - Important safety notes 125
 - Introduction 124
 - Electronic Stability Program**
 - see ESP® (Electronic Stability Program)
 - Emergency**
 - Automatic measures after an accident 53
 - Emergency release**
 - Driver's door 76
 - Trunk 80
 - Vehicle 76
 - Emergency Tensioning Devices**
 - Activation 51
 - Emissions control**
 - Service and warranty information 24
 - Engine**
 - Check Engine warning lamp 222
 - Display message 202
 - ECO start/stop function 124
 - Engine number 309
 - Irregular running 126
 - Jump-starting 273
 - Starting problems 126

- Starting the engine with the SmartKey 123
 - Starting with the Start/Stop button 123
 - Switching off 140
 - Tow-starting (vehicle) 279
 - Engine electronics**
 - Problem (malfunction) 126
 - Engine jump starting**
 - see Jump starting (engine)
 - Engine oil**
 - Adding 256
 - Additives 312
 - Checking the oil level 255
 - Checking the oil level using the dipstick 255
 - Display message 204
 - Filling capacity 312
 - Notes about oil grades 311
 - Notes on oil level/consumption 255
 - Temperature (on-board computer, Mercedes-AMG vehicles) 185
 - Entering an address**
 - see also Digital Operator's Manual 227
 - ESP® (Electronic Stability Program)**
 - AMG menu (on-board computer) ... 186
 - Characteristics 64
 - Deactivating/activating (button in Mercedes-AMG vehicles) 65
 - Deactivating/activating (except Mercedes-AMG vehicles) 64
 - Deactivating/activating (on-board computer, except Mercedes-AMG vehicles) 182
 - Display message 189
 - Function/notes 63
 - General notes 63
 - Important safety information 63
 - Trailer stabilization 66
 - Warning lamp 219
 - ETS/4ETS (Electronic Traction System)** 63
 - Exhaust**
 - see Exhaust pipe
 - Exhaust check** 143
 - Exhaust pipe**
 - Cleaning 263
 - Exterior lighting**
 - Cleaning 262
 - see Lights
 - Exterior mirrors**
 - Adjusting 95
 - Dipping (automatic) 96
 - Folding in when locking (on-board computer) 185
 - Folding in/out (automatically) 96
 - Folding in/out (electrically) 96
 - Out of position (troubleshooting) 96
 - Setting 96
 - Storing settings (memory function) 98
 - Storing the parking position 97
 - Eyeglasses compartment** 234
- ## F
- Favorites**
 - Overview 229
 - Filler cap**
 - see Refueling
 - Flat tire**
 - MOExtended tires 267
 - Preparing the vehicle 266
 - TIREFIT kit 268
 - Floormats** 253
 - Frequencies**
 - Mobile phone 307
 - Two-way radio 307
 - Fuel**
 - Additives 311
 - Consumption statistics 177
 - Displaying the current consumption 178
 - Displaying the range 178
 - Driving tips 143
 - E10 310
 - Fuel gauge 32
 - Grade (gasoline) 310
 - Important safety notes 310
 - Problem (malfunction) 139
 - Refueling 137
 - Tank content/reserve fuel 310

- Fuel filler flap**
Opening 138
- Fuel level**
Calling up the range (on-board computer) 178
- Fuel tank**
Capacity 310
Problem (malfunction) 139
- Fuses**
Allocation chart 280
Before changing 279
Fuse box in the engine compartment 280
Fuse box in the front-passenger footwell 280
Important safety notes 279
- G**
- Garage door opener**
Clearing the memory 251
General notes 249
Important safety notes 249
Opening/closing the garage door .. 251
Problems when programming 251
Programming (button in the rear-view mirror) 249
Synchronizing the rolling code 250
- Gasoline** 310
- Gear indicator (on-board computer, Mercedes-AMG vehicles)** 185
- Genuine parts** 23
- Glove box** 234
- Google™ Local Search**
see also Digital Operator's Manual 227
- H**
- Handbrake**
see Parking brake
- HANDS-FREE ACCESS** 78
- Hazard warning lamps**
Display message 214
Switching on/off 101
- Head restraints**
Adjusting 91
Adjusting (manually) 92
- Adjusting (rear) 92
- Headlamps**
Fogging up 102
see Automatic headlamp mode
- Heating**
see Climate control
- High beam flasher** 100
- High-beam headlamps**
Adaptive Highbeam Assist 101
Display message 200
Replacing bulbs 105
Switching on/off 100
- Hill start assist** 124
- HOLD function**
Activating 156
Deactivating 156
Display message 205
Function/notes 156
- Home address**
see also Digital Operator's Manual 227
- Hood**
Closing 255
Display message 213
Important safety notes 254
Opening 254
- Horn** 31
- Hydroplaning** 147
- I**
- Ignition lock**
see Key positions
- Immobilizer** 67
- Indicator lamp**
Replacing bulbs (rear) 105
- Indicator lamps**
see Warning and indicator lamps
- Indicators**
see Turn signals
- Instrument cluster**
Overview 32
Settings 183
Warning and indicator lamps 32
- Instrument cluster lighting** 174
- Interior lighting**
Control 103
Overview 102

- Reading lamp 102
 - iPod®**
 - see also Digital Operator's Manual 227
- J**
- Jack**
 - Storage location 266
 - Using 303
 - Jump starting (engine)** 273
- K**
- Key positions**
 - Start/Stop button 121
 - KEYLESS-GO**
 - Convenience closing feature 82
 - Deactivation 70
 - Locking 70
 - Unlocking 70
 - Kickdown**
 - Driving tips 133
 - Manual gearshifting 137
 - Knee bag** 45
- L**
- Lamps**
 - see Warning and indicator lamps
 - Lane Keeping Assist**
 - Activating/deactivating (on-board computer) 183
 - Display message 205
 - Function/information 172
 - Lane Tracking package** 171
 - Lap time (RACETIMER)** 186
 - LATCH-type (ISOFIX) child seat anchors** 56
 - License plate lamp (display message)** 200
 - Light function, active**
 - Display message 201
 - Light sensor (display message)** 201
 - Lights**
 - Adaptive Highbeam Assist 101
 - Automatic headlamp mode 99
 - Fogged up headlamps 102
 - Hazard warning lamps 101
 - High beam flasher 100
 - High-beam headlamps 100
 - Light switch 99
 - Low-beam headlamps 100
 - Parking lamps 100
 - Rear fog lamp 100
 - Setting exterior lighting 99
 - Standing lamps 100
 - Switching the daytime running lamps on/off (on-board computer) 184
 - Turn signals 100
- Loading guidelines** 233
 - Locking**
 - see Central locking
 - Locking (doors)**
 - Automatic 76
 - Emergency locking 76
 - From inside (central locking button) 75
 - Locking centrally**
 - see Central locking
 - Locking verification signal (on-board computer)** 185
 - Low-beam headlamps**
 - Display message 199
 - Replacing bulbs 104
 - Switching on/off 100
 - Lumbar support**
 - Adjusting the 4-way lumbar support 92
- M**
- M+S tires** 284
 - Malfunction message**
 - see Display messages
 - Matte finish (cleaning instructions)** 261
 - mbrace**
 - Call priority 245
 - Display message 194
 - Downloading destinations (COMAND) 245
 - Downloading routes 248
 - Emergency call 243
 - General notes 242
 - Geo fencing 248

- Locating a stolen vehicle 247
 - MB info call button 244
 - Remote fault diagnosis 247
 - Remote vehicle locking 247
 - Roadside assistance button 244
 - Search & Send 246
 - Self-test 242
 - Speed alert 248
 - System 242
 - Triggering the vehicle alarm 249
 - Vehicle remote unlocking 246
 - Mechanical key**
 - Function/notes 71
 - Inserting 71
 - Locking vehicle 76
 - Removing 71
 - Unlocking the driver's door 76
 - Memory card (audio)** 180
 - Memory function** 97
 - Message memory (on-board computer)** 188
 - Messages**
 - see Display messages
 - Mirror turn signal**
 - Cleaning 262
 - Mirrors**
 - see Exterior mirrors
 - see Rear-view mirror
 - see Vanity mirror (in the sun visor)
 - Mobile phone**
 - Connecting (Bluetooth® interface) 230
 - Connecting another mobile phone 232
 - Frequencies 307
 - Installation 307
 - Menu (on-board computer) 180
 - Transmission output (maximum) 307
 - Modifying the programming (SmartKey)** 71
 - MOExtended tires** 267
 - Mounting wheels**
 - Lowering the vehicle 305
 - Mounting a new wheel 304
 - Preparing the vehicle 302
 - Raising the vehicle 303
 - Removing a wheel 304
 - Securing the vehicle against rolling away 302
 - MP3**
 - Operation 180
 - see also Digital Operator's Manual 227
 - Multifunction display**
 - Function/notes 176
 - Permanent display 184
 - Multifunction steering wheel**
 - Operating the on-board computer .. 175
 - Overview 33
 - Music files**
 - see also Digital Operator's Manual 227
- ## N
- Navigation**
 - Entering a destination 229
 - Menu (on-board computer) 178
 - see also Digital Operator's Manual 227
 - Notes on breaking-in a new vehicle** 120
- ## O
- Occupant Classification System (OCS)**
 - Conditions 47
 - Faults 50
 - Operation 47
 - System self-test 49
 - Occupant safety**
 - Air bags 44
 - Automatic measures after an accident 53
 - Children in the vehicle 53
 - Important safety notes 39
 - Introduction to the restraint system 39
 - Occupant Classification System (OCS) 46
 - PASSENGER AIR BAG indicator lamps 40
 - Pets in the vehicle 59
 - Restraint system warning lamp 40
 - Seat belt 40

- OCS**
 Conditions 47
 Faults 50
 Operation 47
 System self-test 49
- Odometer** 177
- On-board computer**
 AMG menu 185
 Assistance graphic menu 182
 Assistance menu 182
 Audio menu 180
 Convenience submenu 185
 Display messages 188
 Displaying a service message 258
 Factory settings 185
 Important safety notes 174
 Instrument cluster submenu 183
 Lighting submenu 184
 Menu overview 177
 Message memory 188
 Navigation menu 178
 Operation 175
 RACETIMER 186
 Service menu 183
 Settings menu 183
 Standard display 177
 Telephone menu 180
 Trip menu 177
 Vehicle submenu 184
 Video DVD operation 180
- Opening and closing the side trim panels** 105
- Operating safety**
 Declaration of conformity 26
 Important safety notes 26
- Operating system**
 see On-board computer
- Operation**
 Digital Operator's Manual 22
- Operator's Manual**
 Vehicle equipment 24
- Outside temperature display** 174
- Overhead control panel** 38
- Override feature**
 Rear side windows 59
- P**
- Paint code number** 308
- Paintwork (cleaning instructions) ...** 260
- Panic alarm** 39
- Panorama roof with power tilt/sliding panel**
 Important safety notes 84
 Operating 85
 Operating the roller sunblinds for the sliding sunroof 86
 Problem (malfunction) 88
 Reversing feature 85
- Parking**
 Important safety notes 140
 Parking brake 141
 Parking position for the exterior mirror on the front-passenger side 97
 Rear view camera 166
- Parking aid**
 see Exterior mirrors
 see Rear view camera
- Parking Assist PARKTRONIC**
 Deactivating/activating 161
 Driving system 160
 Function/notes 160
 Important safety notes 160
 Problems (malfunctions) 162
 Sensor range 160
 Warning display 161
- Parking brake**
 Applying automatically 142
 Applying or releasing manually 141
 Display message 191
 Electric parking brake 141
 Emergency braking 142
 General notes 141
 Releasing automatically 142
 Warning lamp 222
- Parking lamps**
 Switching on/off 100
- Parking Pilot**
 Canceling 166
 Detecting parking spaces 163
 Display Message 206
 Exiting a parking space 165
 Function/notes 162

- Important safety notes 162
 - Parking 164
 - PASSENGER AIR BAG**
 - Display message 197
 - Indicator lamps 40
 - Problem (malfunction) 197
 - Pets in the vehicle** 59
 - Phone book**
 - see also Digital Operator's Manual 227
 - Plastic trim (cleaning instructions)** 263
 - Power washers** 260
 - Power windows**
 - see Side windows
 - Protection against theft**
 - ATA (Anti-Theft Alarm system) 67
 - Immobilizer 67
 - Protection of the environment**
 - General notes 23
 - Pulling away**
 - Automatic transmission 124
 - General notes 124
 - Hill start assist 124
- Q**
- QR code**
 - Mercedes-Benz Guide App 1
 - Rescue card 28
 - Qualified specialist workshop** 27
- R**
- RACE START**
 - Important safety notes 157
 - RACE START (Mercedes-AMG vehicles)** 157
 - RACETIMER (on-board computer)** 186
 - Radio**
 - Selecting a station 180
 - see separate operating instructions
 - Radio mode**
 - see also Digital Operator's Manual 227
 - Radio-wave reception/transmission in the vehicle**
 - Declaration of conformity 26
 - Rain closing feature (panorama roof with power tilt/sliding panel)** 86
 - Reading lamp** 102
 - Rear compartment**
 - Setting the air vents 119
 - Rear fog lamp**
 - Display message 200
 - Replacing bulbs 105
 - Switching on/off 100
 - Rear lamps**
 - see Lights
 - Rear seats**
 - Folding the backrest forwards/back 236
 - Rear view camera**
 - "Reverse parking" function 168
 - Cleaning instructions 262
 - Display in the multimedia system .. 167
 - Function/notes 166
 - General notes 166
 - Switching on/off 167
 - Rear window defroster**
 - Problem (malfunction) 118
 - Switching on/off 118
 - Rear-view mirror**
 - Anti-glare (manual) 95
 - Dipping (automatic) 96
 - Refrigerant (air-conditioning system)**
 - Important safety notes 313
 - Refueling**
 - Fuel gauge 32
 - Important safety notes 137
 - Refueling process 138
 - see Fuel
 - Remote control**
 - Garage door opener 249
 - Programming (garage door opener) 249
 - Replacing bulbs**
 - Brake lamp 105
 - High-beam headlamps 105
 - Important safety notes 103
 - Installing/removing the cover (front wheel arch) 104
 - Low-beam headlamps 104
 - Overview of bulb types 103
 - Rear fog lamp 105

- Turn signals (front) 105
 - Turn signals (rear) 105
 - Reporting safety defects** 27
 - Rescue card** 28
 - Reserve (fuel tank)**
 - see Fuel
 - Reserve fuel**
 - Display message 204
 - Warning lamp 222
 - see Fuel
 - Residual heat (climate control)** 118
 - Restraint system**
 - Display message 195
 - Introduction 39
 - Warning lamp 222
 - Warning lamp (function) 40
 - Reverse gear (selector lever)** 131
 - Reversing feature**
 - Panorama sliding sunroof 85
 - Roller sunblind 86
 - Side windows 81
 - Roadside Assistance (breakdown)** 25
 - Roller sunblind**
 - Panorama roof with power tilt/
sliding panel 86
 - Roof carrier** 238
 - Roof lining and carpets (cleaning guidelines)** 265
 - Roof load (maximum)** 314
 - Route guidance**
 - see also Digital Operator's Manual 227
- S**
- Safety**
 - Children in the vehicle 53
 - see Occupant safety
 - Safety system**
 - see Driving safety systems
 - SD card**
 - Inserting 232
 - Inserting/removing 232
 - Removing 232
 - SD memory card**
 - see also Digital Operator's Manual 227
 - Search & Send**
 - see also Digital Operator's Manual 227
 - Seat belts**
 - Adjusting the height 43
 - Cleaning 264
 - Correct usage 42
 - Fastening 43
 - Important safety guidelines 41
 - Introduction 40
 - Releasing 43
 - Warning lamp 216
 - Warning lamp (function) 43
 - Seats**
 - Adjusting (electrically) 91
 - Adjusting (manually) 90
 - Adjusting (Performance Seat) 93
 - Adjusting the 4-way lumbar support 92
 - Adjusting the head restraint 91
 - Cleaning the cover 264
 - Correct driver's seat position 89
 - Folding the backrest (rear compartment) forwards/back 236
 - Important safety notes 89
 - Seat heating problem 94
 - Storing settings (memory function) 98
 - Switching seat heating on/off 93
 - Securing cargo** 237
 - Selector lever**
 - Cleaning 264
 - Sensors (cleaning instructions)** 262
 - Service menu (on-board computer)** 183
 - Service message**
 - see ASSYST PLUS
 - Service products**
 - Brake fluid 312
 - Coolant (engine) 312
 - Engine oil 311
 - Fuel 309
 - Important safety notes 309
 - Refrigerant (air-conditioning system) 313
 - Washer fluid 313
 - Setting the air distribution** 115

- Setting the airflow** 116
- Setting the date/time format**
 - see also Digital Operator's Manual 227
- Setting the language**
 - see also Digital Operator's Manual 227
- Setting the time**
 - see also Digital Operator's Manual 227
- Settings**
 - Factory (on-board computer) 185
 - On-board computer 183
- SETUP (on-board computer)** 186
- Side impact air bag** 45
- Side marker lamp (display message)** 201
- Side windows**
 - Cleaning 261
 - Convenience closing feature 82
 - Convenience opening feature 82
 - Important safety information 80
 - Opening/closing 81
 - Problem (malfunction) 83
 - Resetting 83
 - Reversing feature 81
- SIRIUS services**
 - see also Digital Operator's Manual 227
- Sliding sunroof**
 - see Panorama roof with power tilt/sliding panel
- SmartKey**
 - Changing the battery 72
 - Changing the programming 71
 - Checking the battery 72
 - Convenience closing feature 82
 - Convenience opening feature 82
 - Display message 214
 - Door central locking/unlocking 69
 - Important safety notes 69
 - KEYLESS-GO start function 70
 - Loss 73
 - Mechanical key 71
 - Positions (ignition lock) 121
 - Problem (malfunction) 73
 - Starting the engine 123
- SmartKey positions (ignition lock) ..** 121
- SMS**
 - see also Digital Operator's Manual 227
- Snow chains** 285
- Sockets**
 - Center console 241
 - General notes 241
 - Rear compartment 242
 - Trunk 242
- Sound**
 - Switching on/off 228
- Special seat belt retractor** 54
- Specialist workshop** 27
- Speed, controlling**
 - see Cruise control
- Speedometer**
 - Activating/deactivating the additional speedometer 184
 - Digital 178
 - In the Instrument cluster 32
 - Segments 174
 - Selecting the display unit 183
- SPORT handling mode**
 - Deactivating/activating (Mercedes-AMG vehicles) 65
 - Warning lamp 220
- Standing lamps**
 - Display message 200
 - Switching on/off 100
- Start-off assist**
 - Activating 157
 - Important safety notes 157
- Start/Stop button**
 - Removing 122
 - Starting the engine 123
- Start/stop function**
 - see ECO start/stop function
- Starting (engine)** 122
- STEER CONTROL** 66
- Steering**
 - Display message 214
- Steering assistant STEER CONTROL**
 - see STEER CONTROL
- Steering wheel**
 - Adjusting (manually) 94

- Button overview 33
 - Buttons (on-board computer) 175
 - Cleaning 264
 - Important safety notes 94
 - Paddle shifters 135
 - Steering wheel paddle shifters** 135
 - Stopwatch (RACETIMER)** 186
 - Stowage compartments**
 - Armrest (front) 234
 - Armrest (under) 235
 - Center console 234
 - Center console (rear) 235
 - Cup holders 238
 - Eyeglasses compartment 234
 - Glove box 234
 - Important safety information 233
 - Map pockets 235
 - Stowage net 235
 - Under driver's seat/front-passenger seat 235
 - Stowage net** 235
 - Stowage well beneath the trunk floor** 237
 - Summer tires** 284
 - Sun visor** 240
 - Suspension**
 - Adaptive Damping System 159
 - Suspension setting**
 - AMG adaptive sport suspension system 158
 - Switching air-recirculation mode on/off** 118
 - Switching on media mode**
 - Via the device list 232
- T**
- Tachometer** 174
 - Tail lamps**
 - Display message 200
 - see Lights
 - Tank**
 - see Fuel tank
 - Tank content**
 - Fuel gauge 32
 - Technical data**
 - Capacities 309
 - Information 307
 - Tires/wheels 306
 - Vehicle data 314
 - Telephone**
 - Accepting a call (multifunction steering wheel) 181
 - Authorizing a mobile phone (connecting) 231
 - Connecting a mobile phone (general information) 230
 - Display message 214
 - Introduction 180
 - Menu (on-board computer) 180
 - Number from the phone book 181
 - Redialing 181
 - Rejecting/ending a call 181
 - see also Digital Operator's Manual 227
 - Switching between mobile phones 232
 - Temperature**
 - Coolant 175
 - Coolant (on-board computer, Mercedes-AMG vehicles) 185
 - Engine oil (on-board computer, Mercedes-AMG vehicles) 185
 - Outside temperature 174
 - Setting (climate control) 115
 - Transmission oil (on-board computer, Mercedes-AMG vehicles) 185
 - Through-loading feature** 236
 - Timing (RACETIMER)** 186
 - Tire pressure**
 - Calling up (on-board computer) 289
 - Checking manually 288
 - Display message 209
 - Maximum 288
 - Not reached (TIREFIT) 269
 - Notes 287
 - Reached (TIREFIT) 270
 - Recommended 285
 - Tire pressure loss warning system**
 - General notes 288
 - Important safety notes 288
 - Restarting 289
 - Tire pressure monitor**
 - Checking the tire pressure electronically 291
 - Function/notes 289

- General notes 289
- Important safety notes 290
- Radio type approval for the tire pressure monitor 292
- Restarting 291
- Warning lamp 226
- Warning message 291
- TIREFIT kit** 268
 - Important safety notes 268
 - Storage location 266
 - Tire pressure not reached 269
 - Tire pressure reached 270
- Tires**
 - Aspect ratio (definition) 301
 - Average weight of the vehicle occupants (definition) 299
 - Bar (definition) 299
 - Changing a wheel 301
 - Characteristics 299
 - Checking 282
 - Curb weight (definition) 300
 - Definition of terms 299
 - Direction of rotation 302
 - Display message 209
 - Distribution of the vehicle occupants (definition) 301
 - DOT (Department of Transportation) (definition) 299
 - DOT, Tire Identification Number (TIN) 299
 - GAWR (Gross Axle Weight Rating) (definition) 300
 - General notes 306
 - GVW (Gross Vehicle Weight) (definition) 300
 - GVWR (Gross Vehicle Weight Rating) (definition) 300
 - Important safety notes 282
 - Increased vehicle weight due to optional equipment (definition) 300
 - Information on driving 282
 - Kilopascal (kPa) (definition) 300
 - Labeling (overview) 296
 - Load bearing index (definition) 301
 - Load index 298
 - Load index (definition) 300
 - M+S tires 284
 - Maximum load on a tire (definition) 300
 - Maximum loaded vehicle weight (definition) 300
 - Maximum permissible tire pressure (definition) 300
 - Maximum tire load 298
 - Maximum tire load (definition) 300
 - MOExtended tires 284
 - Optional equipment weight (definition) 301
 - PSI (pounds per square inch) (definition) 301
 - Replacing 301
 - Service life 283
 - Sidewall (definition) 301
 - Speed rating (definition) 300
 - Storing 302
 - Structure and characteristics (definition) 299
 - Summer tires 284
 - Temperature 296
 - TIN (Tire Identification Number) (definition) 301
 - Tire bead (definition) 301
 - Tire pressure (definition) 301
 - Tire pressures (recommended) 300
 - Tire size (data) 306
 - Tire size designation, load-bearing capacity, speed rating 296
 - Tire tread 283
 - Tire tread (definition) 301
 - Total load limit (definition) 301
 - Traction 295
 - Traction (definition) 301
 - Tread wear 295
 - Uniform Tire Quality Grading Standards 295
 - Uniform Tire Quality Grading Standards (definition) 300
 - Wear indicator (definition) 301
 - Wheel rim (definition) 300
 - see Flat tire
- Top Tether** 56
- Tow-starting**
 - Emergency engine starting 279
 - Important safety notes 276
 - Installing the towing eye 277

- Removing the towing eye 277
 - Towing a trailer**
 - ESP® (Electronic Stability Program) 66
 - Towing away**
 - Important safety guidelines 276
 - Installing the towing eye 277
 - Notes for 4MATIC vehicles 279
 - Removing the towing eye 277
 - Transporting the vehicle 278
 - With both axles on the ground 278
 - With front axle raised 277
 - Towing eye** 266
 - Traffic reports**
 - see also Digital Operator's Manual 227
 - Transmission**
 - see Automatic transmission
 - Transmission position display (DIRECT SELECT lever)** 129
 - Transporting the vehicle** 278
 - Trim pieces (cleaning instructions)** 264
 - Trip computer (on-board computer)** 177
 - Trip odometer**
 - Calling up 177
 - Resetting (on-board computer) 178
 - Trunk**
 - Emergency release 80
 - Emergency release button 80
 - Important safety notes 77
 - Opening (automatically from outside) 78
 - Opening (from outside the vehicle, HANDS-FREE ACCESS) 78
 - Opening automatically from inside 79
 - Opening/closing (manually from outside) 77
 - Trunk emergency release button** 80
 - Trunk lid**
 - Display message 213
 - Opening dimensions 314
 - Trunk load (maximum)** 314
 - Turn signals**
 - Display message 199
 - Replacing bulbs (front) 105
 - Switching on/off 100
 - Two-way radio**
 - Frequencies 307
 - Installation 307
 - Transmission output (maximum) 307
 - Type identification plate**
 - see Vehicle identification plate
- U**
- Unlocking**
 - Emergency unlocking 76
 - From inside the vehicle (central unlocking button) 75
 - Upshift indicator (on-board computer, Mercedes-AMG vehicles)** 185
 - USB devices**
 - Connecting to the Media Interface 232
- V**
- Vanity mirror (in the sun visor)** 240
 - Vehicle**
 - Correct use 27
 - Data acquisition 28
 - Display message 211
 - Equipment 24
 - Individual settings 183
 - Limited Warranty 28
 - Loading 292
 - Locking (in an emergency) 76
 - Locking (SmartKey) 69
 - Lowering 305
 - Maintenance 25
 - Parking for a long period 142
 - Pulling away 124
 - Raising 303
 - Reporting problems 27
 - Securing from rolling away 302
 - Transporting 278
 - Unlocking (in an emergency) 76
 - Unlocking (SmartKey) 69
 - Vehicle data 314
 - Vehicle data**
 - Roof load (maximum) 314
 - Trunk load (maximum) 314

- Vehicle dimensions** 314
- Vehicle emergency locking** 76
- Vehicle identification number**
see VIN
- Vehicle identification plate** 308
- Vehicle tool kit** 266
- Ventilation**
Setting the vents 119
- Video**
Operating the DVD 180
see also Digital Operator's Manual 227
- VIN**
Seat 309
Type plate 308
- W**
- Warning and indicator lamps**
ABS 218
Active Brake Assist 225
Brakes 217
Check Engine 222
Coolant 223
Distance warning 225
ESP® 219
ESP® OFF 220
Fuel tank 222
Overview 32
PASSENGER AIR BAG 40
Reserve fuel 222
Restraint system 222
Seat belt 216
SPORT handling mode 220
Tire pressure monitor 226
- Warranty** 24
- Washer fluid**
Display message 214
- Weather display (COMAND)**
see also Digital Operator's Manual 227
- Wheel and tire combinations**
Tires 306
- Wheel bolt tightening torque** 305
- Wheel chock** 302
- Wheels**
Changing a wheel 301
Checking 282
Cleaning 261
Important safety notes 282
Information on driving 282
Interchanging/changing 301
Mounting a new wheel 304
Removing a wheel 304
Storing 302
Tightening torque 305
Wheel size/tire size 306
- Window curtain air bag**
Display message 196
Operation 46
- Windows**
see Side windows
- Windshield**
Defrosting 116
- Windshield washer system**
Adding washer fluid 257
Important safety notes 313
- Windshield wipers**
Display message 214
Problem (malfunction) 108
Replacing the wiper blades 107
Switching on/off 106
- Winter driving**
Slippery road surfaces 147
Snow chains 285
- Winter operation**
General notes 284
- Winter tires**
M+S tires 284
- Wiper blades**
Cleaning 262
Important safety notes 107
- Wooden trim (cleaning instructions)** 264
- Workshop**
see Qualified specialist workshop
- Z**
- ZONE function**
Switching on/off 116

Introduction

The printed Operator's Manual provides information about the safe operation of your vehicle. The Digital Operator's Manual provides comprehensive and specifically adapted information on your vehicle's equipment and multimedia system. You can call up the Digital Operator's Manual via the multimedia system.

- i** You will not incur any costs when calling up the Digital Operator's Manual. The Digital Operator's Manual works without connecting to the Internet.

There are three ways to access the topics of the Digital Operator's Manual:

• Visual search

The visual search allows you to explore your vehicle "virtually". Starting from either the vehicle exterior view or interior view, you can access many of the different topics covered by the Digital Operator's Manual. To access the vehicle interior section, select the "Vehicle interior" view.

• Keyword search

The keyword search allows you to search for a keyword by entering characters.





• Contents

You can select individual sections in the contents.

- i** The Digital Operator's Manual is deactivated for safety reasons while driving.

Operation

Calling up the Digital Operator's Manual

- ▶ Press the  button in the center console. The overview relating to the vehicle appears.
- ▶ Select the "Operator's Manual" menu item by turning  or pressing  the controller.
- ▶ Confirm  the message about the warning and safety notes. The basic menu for the Digital Operator's Manual appears.

Operating the Digital Operator's Manual





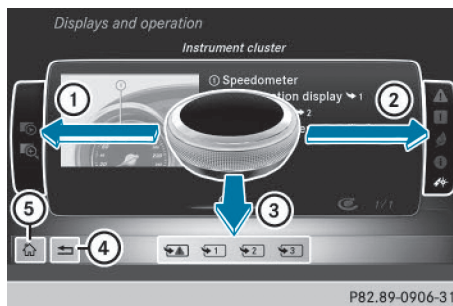

General notes

Please observe the information about the operation of the controller (▷ page 228).

Content pages

The content pages can be accessed by means of a visual search, a keyword search or using the contents.



- ▶ **To scroll forwards/backwards:** turn  the controller.
- ▶ **To display in full-screen or animation:** slide  the controller to the left **1**.
- ▶ **To select information texts or save bookmarks:** slide  the controller to the right **2**.
- ▶ **To select a link:** slide  the controller downwards **3**.
- ▶ **To exit a content page:** select  symbol **4**.
- ▶ **To call up the basic menu of the Digital Operator's Manual:** select  symbol **5**.
- ▶ **To switch functions to the multimedia system using the buttons on the center console:** press the **RADIO**, **TEL**, **MEDIA** or **NAVI** button. The selected menu appears. The Digital Operator's Manual remains open in the background.

Protecting the environment

General notes

Environmental note

Daimler's declared policy is one of comprehensive environmental protection.

The objectives are for the natural resources that form the basis of our existence on this planet to be used sparingly and in a manner that takes the requirements of both nature and humanity into account.

You too can help to protect the environment by operating your vehicle in an environmentally responsible manner.

Fuel consumption and the rate of engine, transmission, brake and tire wear are affected by these factors:

- operating conditions of your vehicle
- your personal driving style

You can influence both factors. You should bear the following in mind:

Operating conditions:

- avoid short trips as these increase fuel consumption.
- always make sure that the tire pressures are correct.
- do not carry any unnecessary weight.
- remove roof racks once you no longer need them.
- a regularly serviced vehicle will contribute to environmental protection. You should therefore adhere to the service intervals.
- always have service work carried out at a qualified specialist workshop.

Personal driving style:

- do not depress the accelerator pedal when starting the engine.
- do not warm up the engine when the vehicle is stationary.
- drive carefully and maintain a safe distance from the vehicle in front.
- avoid frequent, sudden acceleration and braking.

- change gear in good time and use each gear only up to $\frac{2}{3}$ of its maximum engine speed.
- switch off the engine in stationary traffic.
- keep an eye on the vehicle's fuel consumption.

Environmental concerns and recommendations

Wherever the Operator's Manual requires you to dispose of materials, first try to regenerate or reuse them. Observe the relevant environmental rules and regulations when disposing of materials. In this way you will help to protect the environment.

Genuine Mercedes-Benz parts

Environmental note

Daimler AG also supplies reconditioned major assemblies and parts which are of the same quality as new parts. They are covered by the same Limited Warranty entitlements as new parts.

! Air bags and Emergency Tensioning Devices, as well as control units and sensors for these restraint systems, may be installed in the following areas of your vehicle:

- doors
- door pillars
- door sills
- seats
- cockpit
- instrument cluster
- center console

Do not install accessories such as audio systems in these areas. Do not carry out repairs or welding. You could impair the operating efficiency of the restraint systems.

Have aftermarket accessories installed at a qualified specialist workshop.

You could jeopardize the operating safety of your vehicle if you use parts, tires and wheels as well as accessories relevant to safety which have not been approved by Mercedes-Benz. This could lead to malfunctions in safety-relevant

systems, e.g. the brake system. Use only genuine Mercedes-Benz parts or parts of equal quality. Only use tires, wheels and accessories that have been specifically approved for your vehicle.

Genuine Mercedes-Benz parts are subject to strict quality control. Every part has been specifically developed, manufactured or selected for and adapted to Mercedes-Benz vehicles. Therefore, only genuine Mercedes-Benz parts should be used.

More than 300,000 different genuine Mercedes-Benz parts are available for Mercedes-Benz models.

All authorized Mercedes-Benz Centers maintain a supply of genuine Mercedes-Benz parts for necessary service and repair work. In addition, strategically located parts delivery centers provide quick and reliable parts service.

Always specify the vehicle identification number (VIN) when ordering genuine Mercedes-Benz parts (> page 308).

Operator's Manual

Vehicle equipment

i This Operator's Manual describes all models and all standard and optional equipment of your vehicle available at the time of going to print. Country-specific differences are possible. Bear in mind that your vehicle may not feature all functions described here. This also applies to safety-relevant systems and functions. The equipment in your vehicle may therefore differ from that shown in the descriptions and illustrations.

The original purchase agreement lists all systems installed in your vehicle.

Should you have any questions concerning equipment and operation, please consult an authorized Mercedes-Benz Center.

The Operator's Manual and Maintenance Booklet are important documents and should be kept in the vehicle.

Service and vehicle operation

Warranty

The Limited Warranty for your vehicle applies in accordance with the warranty terms and condi-

tions in the Service and Warranty Information booklet.

Your authorized Mercedes-Benz Center will replace and repair all factory-installed parts in accordance with the following warranty terms and conditions:

- New Vehicle Limited Warranty
- Emission System Warranty
- Emission Performance Warranty
- California, Connecticut, Maine, Massachusetts, New York, Pennsylvania, Rhode Island and Vermont Emission Control System Warranty
- State warranty enforcement laws (lemon laws)

Replacement parts and accessories are covered by the Mercedes-Benz Parts and Accessories warranties. These are available at any authorized Mercedes-Benz Center.

i Should you lose your Service and Warranty Information booklet, have an authorized Mercedes-Benz Center arrange for a replacement. The new Service and Warranty Information booklet will be posted to you.

Information for customers in California

Under California law you may be entitled to a replacement of your vehicle or a refund of the purchase price or lease price, if after a reasonable number of repair attempts Mercedes-Benz USA, LLC and/or its authorized repair or service facilities fail to fix one or more substantial defects or malfunctions in the vehicle that are covered by its express warranty.

During the period of 18 months from original delivery of the vehicle or the accumulation of 18,000 miles (approximately 29,000 km) on the odometer of the vehicle, whichever occurs first, a reasonable number of repair attempts is presumed for a retail buyer or lessee if one or more of the following occurs:

- (1) the same substantial defect or malfunction results in a condition that is likely to cause death or serious bodily injury if the vehicle is driven, that defect or malfunction has been subject to repair two or more times, and you

- have directly notified Mercedes-Benz USA, LLC in writing of the need for its repair.
- (2) the same substantial defect or malfunction of a less serious nature than category (1) has been subject to repair four or more times and you have directly notified Mercedes-Benz in writing of the need for its repair.
 - (3) the vehicle is out of service by reason of repair of the same or different substantial defects or malfunctions for a cumulative total of more than 30 calendar days.

Please send your written notice to:
 Customer Assistance Center
 Mercedes-Benz USA, LLC
 3 Mercedes Drive
 Montvale, NJ 07645-0350

Maintenance

Always bring the Maintenance Booklet with you when taking the vehicle to an authorized Mercedes-Benz Center. Your customer service advisor will enter every service into your Maintenance Booklet on your behalf.

Roadside Assistance

The Mercedes-Benz Roadside Assistance Program offers technical help in the event of a breakdown. Calls to the toll-free Roadside Assistance Hotline are answered by our agents 24 hours a day, 365 days a year.

1-800-FOR-MERCEdes(1-800-367-6372)
(USA)

1-800-387-0100(Canada)

For additional information, refer to the Mercedes-Benz Roadside Assistance Program brochure (USA) or the "Roadside Assistance" section in the Service and Warranty Booklet (Canada). You will find both in the vehicle document wallet.

Change of address or change of ownership

In the event of a change of address, please send us the "Notification of Address Change" in the Service and Warranty Booklet or simply call the Mercedes-Benz Customer Assistance Center

(USA) at the hotline number 1-800-FOR-MERCEdes (1-800-367-6372) or Customer Service Center (Canada) at 1-800-387-0100. This will assist us in contacting you in a timely manner should the need arise. If you sell your Mercedes, please leave all literature in the vehicle so that it is available to the next owner.

If you have purchased a used car, please send us the "Notification of Used Car Purchase" in the Service and Warranty Booklet or simply call the Mercedes-Benz Customer Assistance Center (USA) at the hotline number 1-800-FOR-MERCEdes (1-800-367-6372) or Customer Service (Canada) at 1-800-387-0100.

Vehicle operation outside the USA and Canada

When you are abroad with your vehicle, observe the following points:

- Service facilities or replacement parts may not be readily available.
- Lead-free fuel for vehicles with a catalytic converter may not be available. Leaded fuel can cause damage to the catalytic converter.
- The fuel may have a considerably lower octane number. Unsuitable fuel can cause engine damage.

Some Mercedes-Benz models are available for delivery in Europe through our European Delivery Program. For details, consult an authorized Mercedes-Benz Center or write to one of the following addresses.

In the USA

Mercedes-Benz USA, LLC
 European Delivery Department
 One Mercedes Drive
 Montvale, NJ 07645-0350

In Canada

Mercedes-Benz Canada, Inc.
 European Delivery Department
 98 Vanderhoof Avenue
 Toronto, Ontario M4G 4C9

Operating safety

Important safety notes

WARNING

If you do not have the prescribed service/maintenance work or any required repairs carried out, this can result in malfunctions or system failures. There is a risk of an accident.

Always have the prescribed service/maintenance work as well as any required repairs carried out at a qualified specialist workshop.

WARNING

Flammable material such as leaves, grass or twigs may ignite if they come into contact with hot parts of the exhaust system. There is a risk of fire.

When driving off road or on unpaved roads, check the vehicle's underside regularly. In particular, remove parts of plants or other flammable materials which have become trapped. In the case of damage, contact a qualified specialist workshop.

WARNING

Modifications to electronic components, their software as well as wiring can impair their function and/or the function of other networked components. In particular, systems relevant to safety could also be affected. As a result, these may no longer function as intended and/or jeopardize the operating safety of the vehicle. There is an increased risk of an accident and injury.

Never tamper with the wiring as well as electronic components or their software. You should have all work to electrical and electronic equipment carried out at a qualified specialist workshop.

 There is a risk of damage to the vehicle if:

- the vehicle becomes stuck, e.g. on a high curb or an unpaved road
- you drive too fast over an obstacle, e.g. a curb, speed bumps or a pothole in the road
- a heavy object strikes the underbody or parts of the chassis

In situations like this, the body, the underbody, chassis parts, wheels or tires could be damaged without the damage being visible. Components damaged in this way can unexpectedly fail or, in the case of an accident, no longer withstand the strain they are designed to.

If the underbody paneling is damaged, combustible materials such as leaves, grass or twigs can gather between the underbody and the underbody paneling. If these materials come in contact with hot parts of the exhaust system, they can catch fire.

In such situations, have the vehicle checked and repaired immediately at a qualified specialist workshop. If on continuing your journey you notice that driving safety is impaired, pull over and stop the vehicle immediately, paying attention to road and traffic conditions. In such cases, consult a qualified specialist workshop.

Declarations of conformity

USA: "The wireless devices of this vehicle comply with Part 15 of the FCC Rules. Operation is subject to the two following two conditions: 1) These devices may not cause harmful interference, and 2) These devices must accept any interference received, including interference that may cause undesired operation. Changes or modifications not expressly approved by the party responsible for compliance could void the user's authority to operate the equipment."

Canada: "The wireless devices of this vehicle comply with Industry Canada license-exempt RSS standard(s). Operation is subject to the following two conditions: (1) These devices may not cause interference, and (2) These devices must accept any interference, including interference that may cause undesired operation of the device."

Diagnostics connection

The diagnostics connection is only intended for the connection of diagnostic equipment at a qualified specialist workshop.

WARNING

If you connect equipment to a diagnostics connection in the vehicle, it may affect the operation of vehicle systems. As a result, the operating safety of the vehicle could be affected. There is a risk of an accident.

Only connect equipment to a diagnostics connection in the vehicle, which is approved for your vehicle by Mercedes-Benz.

WARNING

Objects in the driver's footwell can restrict the pedal travel or obstruct a depressed pedal. The operating and road safety of the vehicle is jeopardized. There is a risk of an accident.

Make sure that all objects in the vehicle are stowed correctly, and that they cannot enter the driver's footwell. Install the floor mats securely and as specified in order to ensure sufficient clearance for the pedals. Do not use loose floor mats and do not place floor mats on top of one another.

! If the engine is switched off and equipment on the diagnostics connection is used, the starter battery may discharge.

Connecting equipment to the diagnostics connection can lead to emissions monitoring information being reset, for example. This may lead to the vehicle failing to meet the requirements of the next emissions test during the main inspection.

Qualified specialist workshop

An authorized Mercedes-Benz Center is a qualified specialist workshop. It has the necessary specialist knowledge, tools and qualifications to correctly carry out the work required on your vehicle. This is especially the case for work relevant to safety.

Observe the notes in the Maintenance Booklet.

Always have the following work carried out at an authorized Mercedes-Benz Center:

- work relevant to safety
- service and maintenance work
- repair work
- alterations, installation work and modifications
- work on electronic components

Correct use

If you remove any warning stickers, you or others could fail to recognize certain dangers.

Leave warning stickers in position.

Observe the following information when driving your vehicle:

- the safety notes in this manual
- technical data for the vehicle
- traffic rules and regulations
- laws and safety standards pertaining to motor vehicles

Problems with your vehicle

If you should experience a problem with your vehicle, particularly one that you believe may affect its safe operation, we urge you to contact an authorized Mercedes-Benz Center immediately to have the problem diagnosed and rectified. If the problem is not resolved to your satisfaction, please discuss the problem again with an authorized Mercedes-Benz Center or, if necessary, contact us at one of the following addresses.

In the USA

Customer Assistance Center
Mercedes-Benz USA, LLC
3 Mercedes Drive
Montvale, NJ 07645-0350

In Canada

Customer Relations Department
Mercedes-Benz Canada, Inc.
98 Vanderhoof Avenue
Toronto, Ontario M4G 4C9

Reporting safety defects

USA only:

The following text is reproduced as required of all manufacturers under Title 49, Code of U.S. Federal Regulations, Part 575 pursuant to the National Traffic and Motor Vehicle Safety Act of 1966.

If you believe that your vehicle has a defect which could cause a crash or could cause injury or death, you should immediately inform the National Highway Traffic Safety Administration (NHTSA) in addition to notifying Mercedes-Benz USA, LLC.

If NHTSA receives similar complaints, it may open an investigation, and if it finds that a safety defect exists in a group of vehicles, it may order a recall and remedy campaign. However, NHTSA cannot become involved in individual problems between you, your dealer, or Mercedes-Benz USA, LLC.

To contact NHTSA, you may call the Vehicle Safety Hotline toll-free at 1-888-327-4236 (TTY: 1-800-424-9153); go to <http://www.safercar.gov>; or write to: Administrator, NHTSA, 400 Seventh Street, SW., Washington, DC 20590.

You can also obtain other information about motor vehicle safety from

<http://www.safercar.gov>

Limited Warranty

! Follow the instructions in this manual about the proper operation of your vehicle as well as about possible vehicle damage. Damage to your vehicle that arises from culpable contraventions against these instructions is not covered either by the Mercedes-Benz Limited Warranty or by the New or Used-Vehicle Warranty.

QR codes for the rescue card

The QR codes are secured in the fuel filler flap and on the opposite side on the B-pillar. In the event of an accident, rescue services can use the QR code to quickly find the appropriate rescue card for your vehicle. The current rescue card contains the most important information about your vehicle in a compact form, e.g. the routing of the electric cables.

You can find more information under www.mercedes-benz.de/qr-code.

Data stored in the vehicle

Data storage

A wide range of electronic components in your vehicle contain data memories.

These data memories temporarily or permanently store technical information about:

- the vehicle's operating state
- incidents
- malfunctions

In general, this technical information documents the state of a component, a module, a system or the surroundings.

These include, for example:

- operating conditions of system components, e.g. fluid levels
- the vehicle's status messages and those of its individual components, e.g. number of wheel revolutions/speed, deceleration in movement, lateral acceleration, accelerator pedal position
- malfunctions and defects in important system components, e.g. lights, brakes
- vehicle reactions and operating conditions in special driving situations, e.g. air bag deployment, intervention of stability control systems
- ambient conditions, e.g. outside temperature

This data is of an exclusively technical nature and can be used to:

- assist in recognizing and rectifying malfunctions and defects
- analyze vehicle functions, e.g. after an accident
- optimize vehicle functions

The data cannot be used to trace the vehicle's movements.

When your vehicle is serviced, technical information can be read from the event data memory and malfunction data memory.

Services include, for example:

- repair services
- service processes
- warranties
- quality assurance

The vehicle is read out by employees of the service network (including the manufacturer) using special diagnostic testers. More detailed information is obtained from it, if required.

After a malfunction has been rectified, the information is deleted from the malfunction memory or is continually overwritten.

When operating the vehicle, situations are conceivable in which this technical data, in connection with other information (if necessary, under consultation with an authorized expert), could be traced to a person.

Examples include:

- accident reports
- damage to the vehicle
- witness statements

Further additional functions that have been contractually agreed upon with the customer allow certain vehicle data to be conveyed by the vehicle as well. The additional functions include, for example, vehicle location in case of an emergency.

COMAND/mbrace

If the vehicle is equipped with COMAND or mbrace, additional data about the vehicle's operation, the use of the vehicle in certain situations, and the location of the vehicle may be compiled through COMAND or the mbrace system.

For additional information please refer to the COMAND User Manual or the Digital Operator's Manual and/or the mbrace Terms and Conditions.

Event data recorders

This vehicle is equipped with an event data recorder (EDR). This vehicle is equipped with an event data recorder (EDR). The main purpose of an EDR is to record, in certain crash or near crash-like situations, such as an air bag deployment or hitting a road obstacle, data that will assist in understanding how a vehicle's systems performed. The EDR is designed to record data related to vehicle dynamics and safety systems for a short period of time, typically 30 seconds or less.

The EDR in this vehicle is designed to record such data as:

- How various systems in your vehicle were operating
- Whether or not the driver and passenger safety belts were buckled/fastened

- How far (if at all) the driver was depressing the accelerator and/or brake pedal and
- How fast the vehicle was traveling.

These data can help provide a better understanding of the circumstances in which crashes and injuries occur. NOTE: EDR data are recorded by your vehicle only if a non-trivial crash situation occurs; no data are recorded by the EDR under normal driving conditions and no personal data (e.g. name, gender, age and crash location) are recorded. However, other parties, such as law enforcement could combine the EDR data with the type of personally identifying data routinely acquired during a crash investigation.

Access to the vehicle and/or the EDR is needed to read data that is recorded by an EDR, and special equipment is required. In addition to the vehicle manufacturer, other parties that have the special equipment, such as law enforcement, can read the information by accessing the vehicle or the EDR.

EDR data may be used in civil and criminal matters as a tool in accident reconstruction, accident claims and vehicle safety. Since the Crash Data Retrieval CDR tool that is used to extract data from the EDR is commercially available, Mercedes-Benz USA, LLC ("MBUSA") expressly disclaims any and all liability arising from the extraction of this information by unauthorized Mercedes-Benz personnel.

MBUSA will not share EDR data with others without the consent of the vehicle owners or, if the vehicle is leased, without the consent of the lessee. Exceptions to this representation include responses to subpoenas by law enforcement; by federal, state or local government; in connection with or arising out of litigation involving MBUSA or its subsidiaries and affiliates; or, as required by law.

Warning: The EDR is a component of the Restraint System Module. Tampering with, altering, modifying or removing the EDR component may result in a malfunction of the Restraint System Module and other systems.

State laws or regulations regarding EDRs that conflict with federal regulation are pre-empted. This means that in the event of such conflict, the federal regulation governs. As of February 2013, 13 states have enacted laws relating to EDRs.

Information on copyright

General information

Information on license for free and open-source software used in your vehicle and its electronic components is available on the following website:

<http://www.mercedes-benz.com/opensource>

Registered trademarks

- Bluetooth® is a registered trademark of Bluetooth SIG Inc.
- DTS™ is a registered trademark of DTS, Inc.
- Dolby® and MLP™ are registered trademarks of DOLBY Laboratories.
- BabySmart™, ESP® and PRE-SAFE® are registered trademarks of Daimler AG.
- HomeLink® is a registered trademark of Johnson Controls.
- iPod® and iTunes® are registered trademarks of Apple Inc.
- Logic7® is a registered trademark of Harman International Industries.
- Microsoft® and Windows media® are registered trademarks of Microsoft Corporation.
- SIRIUS® is a registered trademark of Sirius XM Radio Inc.
- HD Radio™ is a registered trademark of iBiquity Digital Corporation.
- Gracenote® is a registered trademark of Gracenote, Inc.
- ZAGAT Survey® and related brands are registered trademarks of Zagat Survey, LLC.

Cockpit

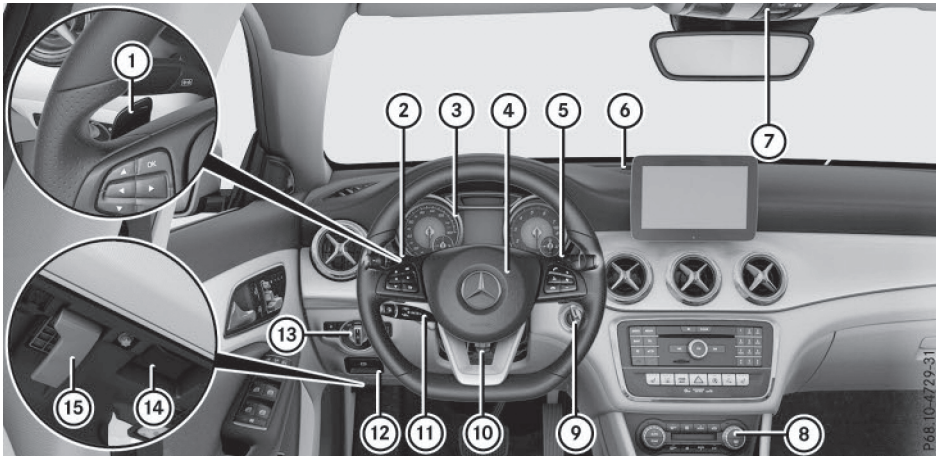

At a glance

	Function	Page		Function	Page
①	Steering wheel paddle shifters	135	⑧	Climate control systems	109
②	Combination switch	100	⑨	Ignition lock	121
③	Instrument cluster	32	⑩	Adjusts the steering wheel	94
④	Horn		⑪	Cruise control lever	148
⑤	DIRECT SELECT lever	129	⑫	Electric parking brake	141
⑥	Parking Assist PARKTRONIC warning display	161	⑬	Light switch	99
⑦	Overhead control panel	38	⑭	Diagnostics connection	27
			⑮	Opens the hood	254

Instrument cluster

At a glance

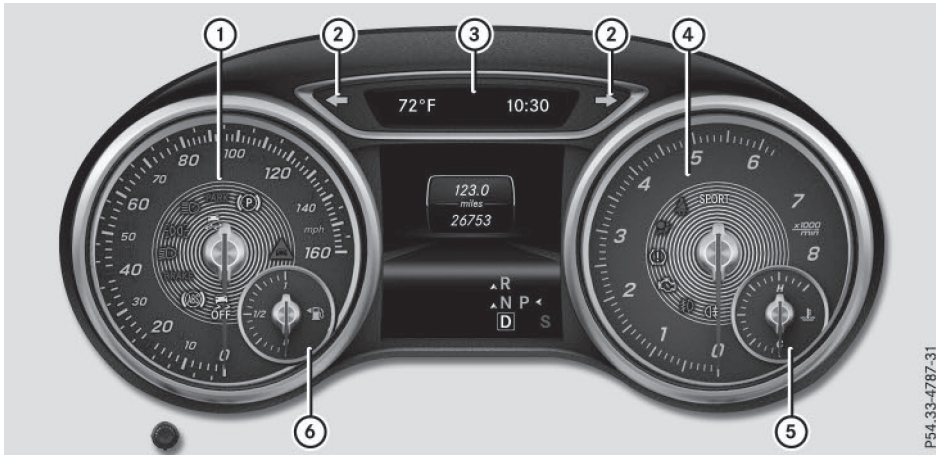

P54.33-4787-31

	Function	Page		Function	Page
①	Speedometer with segments Warning and indicator lamps: Low-beam headlamps Parking lamps High-beam headlamps ESP® Electric parking brake applied (red) (USA only) (Canada only) Electric parking brake (yellow) Distance warning ESP® OFF ABS malfunctioning Brakes (USA only) (Canada only)	174	②	Turn signals	100
			③	Multifunction display	176
			④	Tachometer Restraint system Seat belt not fastened SPORT handling mode (Mercedes-AMG vehicles) Rear fog lamp Check Engine Tire pressure monitor	174 40 216 220 100 222 226
			⑤	Coolant temperature gauge Warning and indicator lamps: Coolant too hot/cold	175 223
			⑥	Fuel level indicator Warning and indicator lamps: Reserve fuel	222

Multifunction steering wheel

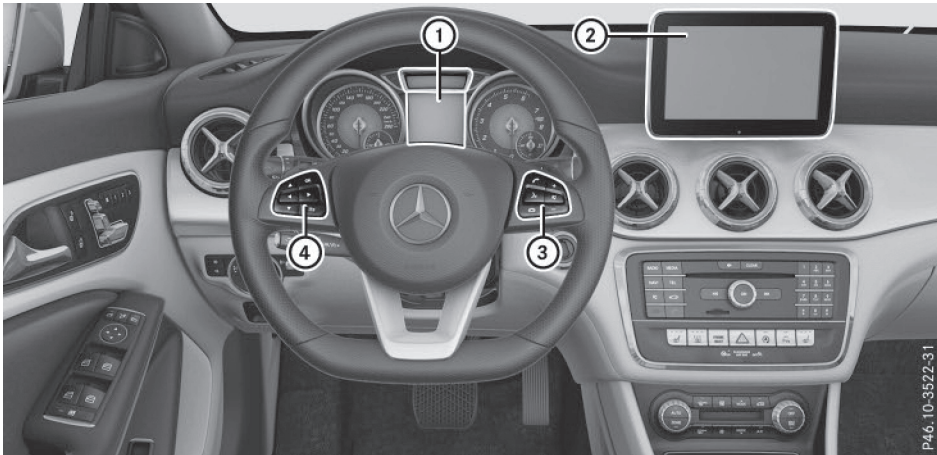

At a glance

	Function	Page
①	Multifunction display	176
②	Multimedia system display	
③	Rejects or ends a call Makes or accepts a call Further telephone functions Adjusts volume Mute Switches on voice-operated control of the navigation system or the Voice Control System	180

	Function	Page
④	Opens the menu list Selects a menu Confirms the selection Back Operates the on-board computer Switches off voice-operated control of the navigation system or the Voice Control System	175

i In vehicles with multimedia system Audio 20 you can find further information:

- on the multimedia system in the Digital Operator's Manual
- on voice-operated control of the navigation system in the manufacturer's operating instructions

i In vehicles with multimedia system COMAND you can find further information:



- on the multimedia system in the Digital Operator's Manual
- on the DVD changer or single DVD drive in the Digital Operator's Manual
- on the Voice Control System in the separate operating instructions



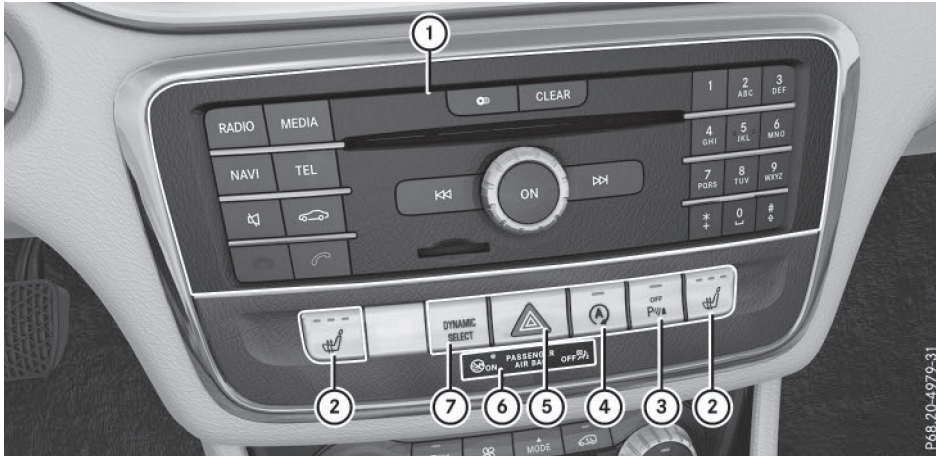

Center console

Center console, upper section

At a glance



	Function	Page
①	Multimedia system (see the separate operating instructions)	
②	 Seat heating Mercedes-AMG vehicles: AMG adaptive sport suspension system (left side)	93 158
	Mercedes-AMG vehicles: adjusts the exhaust flap of the AMG performance exhaust system (right side)	126
③	 Parking Assist PARKTRONIC	161

	Function	Page
④	 ECO start/stop function	124
⑤	 Hazard warning lamps	101
⑥	 PASSENGER AIR BAG indicator lamp	40
⑦	 DYNAMIC SELECT button  Mercedes-AMG vehicles: ESP®	127 65

Center console, lower section

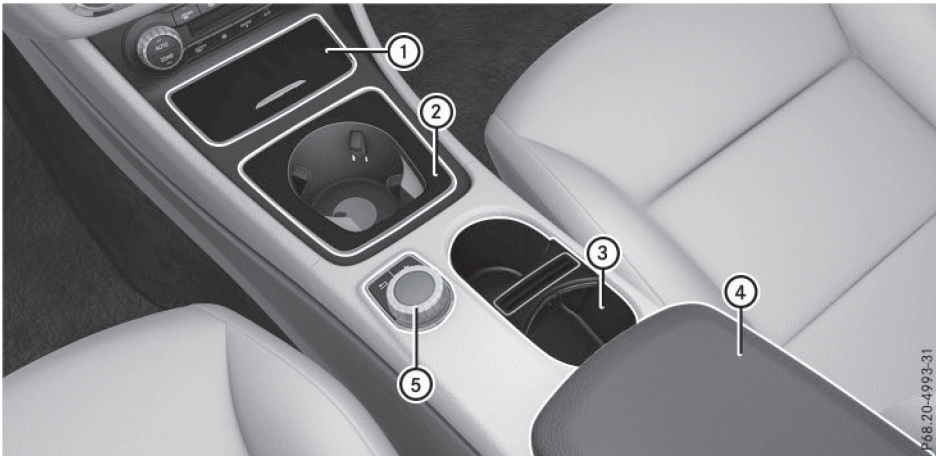

At a glance

	Function	Page		Function	Page
①	Ashtray	240	④	Stowage compartment with Media Interface	233
	Cigarette lighter	241			
	Socket	241	⑤	Multimedia system controller (see the separate operating instructions)	
	Stowage compartment	233			
②	Cup holder	238			
③	Cup holder	238			

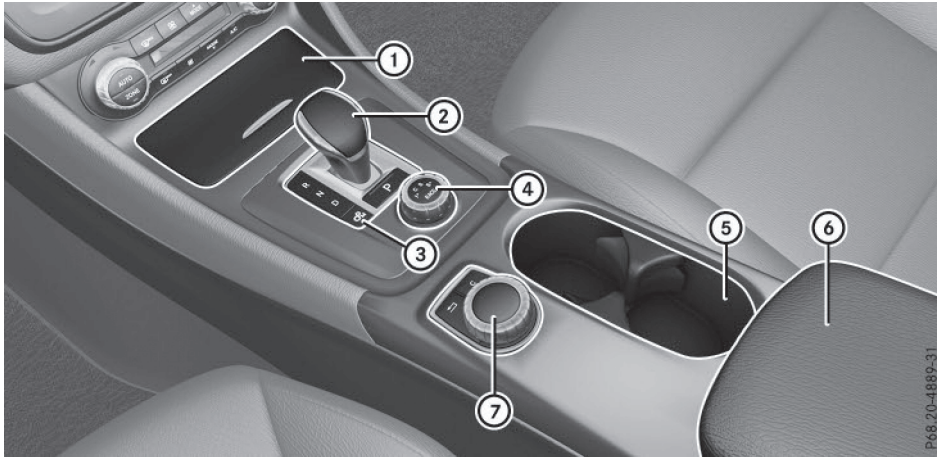

i Mercedes-AMG vehicles

	Function	Page
①	Ashtray	240
	Cigarette lighter	241
	Socket	241
	Stowage compartment	233
②	Selector lever	131
③	Manual gearshifting (permanent setting)	135

	Function	Page
④	DYNAMIC SELECT controller	128
⑤	Cup holder	238
⑥	Stowage compartment with Media Interface	233
⑦	Multimedia system controller (see the separate operating instructions)	

Door control panel

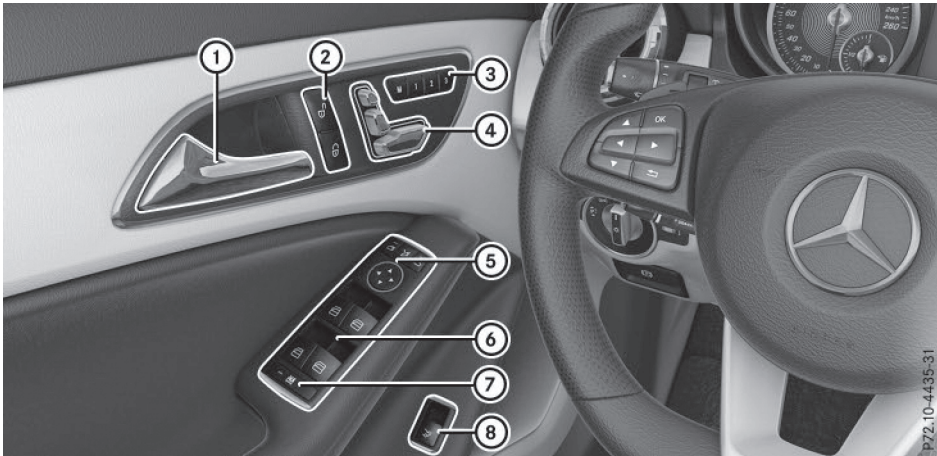

At a glance

	Function	Page
①	Opens the door	75
②	Unlocks/locks the vehicle	75
③	Saves the seat and exterior mirror settings	97
④	Adjusts the seats electrically	91
⑤	Adjusts and folds the exterior mirrors in/out electrically	95

	Function	Page
⑥	Opens/closes the side windows	81
⑦	Activates/deactivates the override feature for the side windows in the rear compartment	59
⑧	Opens the trunk	79

Overhead control panel

At a glance

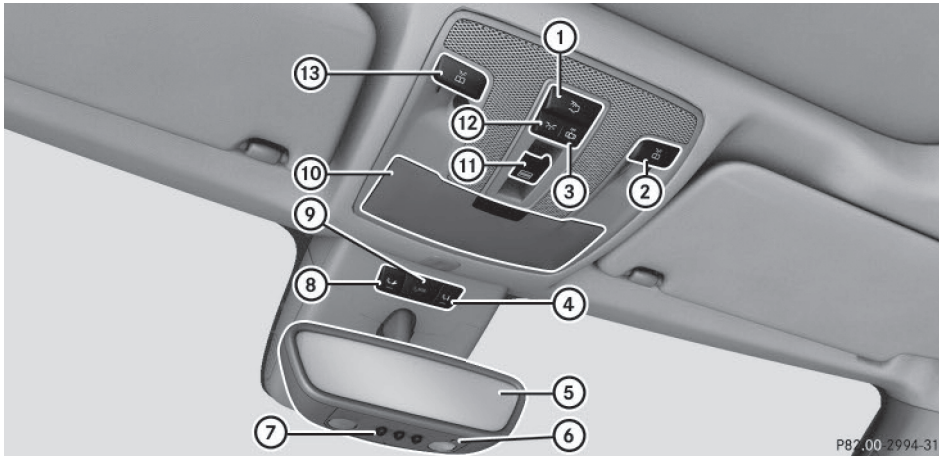

PB2.00.2994-31

	Function	Page
①	Switches the rear compartment interior lighting on/off	102
②	Switches the right-hand reading lamp on/off	102
③	Switches the front interior lighting/automatic interior lighting control off	102
④	MB Info call button (mbrace system)	244
⑤	Rear-view mirror	96
⑥	Sets the compass	252
⑦	Buttons for the garage door opener	249

	Function	Page
⑧	Roadside assistance call button (mbrace system)	244
⑨	SOS button (mbrace system)	243
⑩	Eyeglasses compartment	234
⑪	Opens/closes the panorama roof with power tilt/sliding panel with roller sunblinds	85
⑫	Switches the front interior lighting on	102
⑬	Switches the left-hand reading lamp on/off	102

Panic alarm

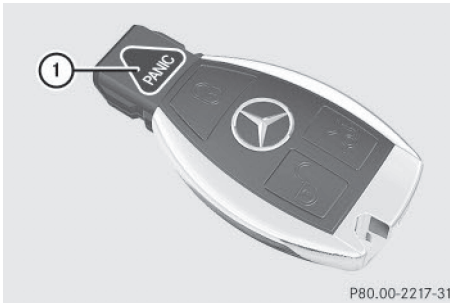

P80.00-2217-31

- ▶ **To activate:** press and hold the **PANIC** button ① for approx. one second. A visual and audible alarm is triggered if the alarm system is armed.
- ▶ **To deactivate:** press **PANIC** button ① again.
or
- ▶ Insert the SmartKey into the ignition lock.
or, in vehicles with KEYLESS-GO start-function or KEYLESS-GO
- ▶ Press the Start/Stop button.
The SmartKey must be in the vehicle.

Occupant safety

Introduction to the restraint system

The restraint system can reduce the risk of vehicle occupants coming into contact with parts of the vehicle's interior in the event of an accident. The restraint system can also reduce the forces to which vehicle occupants are subjected during an accident.

The restraint system comprises:

- seat belt system
- air bags
- child restraint system
- child seat securing systems

The components of the restraint system work in conjunction with each other. They can only deploy their protective function if, at all times, all vehicle occupants:

- have fastened their seat belts correctly (▷ page 42)
- have adjusted their seat and head restraint properly (▷ page 89).

As the driver, you also have to make sure that the steering wheel is adjusted correctly. Observe the information relating to the correct driver's seat position (▷ page 89).

You also have to make sure that an air bag can inflate properly if deployed (▷ page 44).

An air bag supplements a correctly worn seat belt. As an additional safety device, the air bag increases the level of protection for vehicle occupants in the event of an accident. For example, if, in the event of an accident, the protection offered by the seat belt is sufficient, the air bags are not deployed. When an accident occurs, only the air bags that increase protection in that particular accident situation are deployed. However, seat belts and air bags generally do not protect against objects penetrating the vehicle from the outside.

Information on restraint system operation can be found under "Triggering of the Emergency Tensioning Devices and air bags" (▷ page 51).

For information on children traveling with you in the vehicle and on child restraint systems, see "Children in the vehicle" (▷ page 53).

Important safety notes

WARNING

Modifications to the restraint system may cause it to no longer work as intended. The restraint system may then not perform its intended protective function and may fail in an accident or trigger unexpectedly, for example. This poses an increased risk of injury or even fatal injury.

Never modify parts of the restraint system. Never tamper with the wiring, the electronic components or their software.

If it is necessary to modify components of the restraint system to accommodate a person with disabilities, contact an authorized Mercedes-Benz Center for details. USA only: for further information contact our Customer Assistance Center at 1-800-FOR-MERCEDES (1-800-367-6372).

Mercedes-Benz recommends that you only use driving aids which have been approved specifically for your vehicle by Mercedes-Benz.

Restraint system warning lamp

The functions of the restraint system are checked after the ignition is switched on and at regular intervals while the engine is running. Therefore, malfunctions can be detected in good time.

The  restraint system warning lamp in the instrument cluster lights up when the ignition is switched on. It goes out no later than a few seconds after the vehicle is started. The components of the restraint system are in operational readiness.

A malfunction has occurred if the  restraint system warning lamp:

- does not light up after the ignition is switched on
- does not go out after a few seconds with the engine running
- lights up again while the engine is running



WARNING

If the restraint system is malfunctioning, restraint system components may be triggered unintentionally or may not deploy as intended during an accident. This can affect for example the Emergency Tensioning Device or the air bag. This poses an increased risk of injury or even fatal injury.

Have the restraint system checked and repaired in a qualified specialist workshop as soon as possible.

PASSENGER AIR BAG indicator lamp



PASSENGER AIR BAG ON indicator lamp  and PASSENGER AIR BAG OFF indicator lamp  are part of the Occupant Classification System (OCS).

The indicator lamps display the status of the front-passenger front air bag.

- PASSENGER AIR BAG ON lights up for 60 seconds, subsequently both indicator lamps are off (PASSENGER AIR BAG ON and OFF): the front-passenger front air bag is able to deploy in the event of an accident.
- PASSENGER AIR BAG OFF lights up: the front-passenger front air bag is deactivated. It will then not be deployed in the event of an accident.

If the PASSENGER AIR BAG ON indicator lamp is off, only the PASSENGER AIR BAG OFF indicator lamp shows the status of the front-passenger front air bag. The PASSENGER AIR BAG OFF indicator lamp may be lit continuously or be off. Depending on the person in the front-passenger seat, the front-passenger front air bag must either be deactivated or enabled; see the following points. You must make sure of this both before and during a journey.

- **Children in a child restraint system:** whether the front-passenger front air bag is enabled or deactivated depends on the installed child restraint system, and the age and size of the child. Therefore, be sure to observe the notes on the "Occupant Classification System (OCS)" ([▷ page 46](#)) and on "Children in the vehicle" ([▷ page 53](#)). There you will also find instructions on rearward and forward-facing child restraint systems on the front-passenger seat.
- **All other persons:** depending on the classification of the person in the front-passenger seat, the front-passenger front air bag is enabled or deactivated ([▷ page 46](#)). Be sure to observe the notes on "Seat belts" ([▷ page 40](#)) and "Air bags" ([▷ page 44](#)). There you can also find information on the correct seat position.

Seat belts

Introduction

Seat belts are the most effective means of restricting the movement of vehicle occupants in the event of an accident or the vehicle rolling over. This reduces the risk of vehicle occupants coming into contact with parts of the vehicle interior or being ejected from the vehicle. Furthermore, the seat belt helps to keep the vehicle

occupant in the best position in relation to the air bag.

The seat belt system comprises:

- Seat belts
- Emergency Tensioning Devices for the front seat belts and the outer seat belts in the rear
- Seat belt force limiters for the front seat belts and the outer seat belts in the rear

If the seat belt is pulled out of the belt outlet quickly or with a jerky movement, the belt retractor locks. The belt strap cannot be extracted any further.

The Emergency Tensioning Device tightens the seat belt in an accident, pulling the belt close against the body. However it does not pull the vehicle occupant back in the direction of the backrest.

The Emergency Tensioning Device does not correct an incorrect seat position or the routing of an incorrectly fastened seat belt.

When triggered, a seat belt force limiter helps to reduce the force exerted by the seat belt on the vehicle occupant.

The seat belt force limiters for the front seats are synchronized with the front air bags, which absorb part of the deceleration force. This can reduce the force exerted on the vehicle occupants during an accident.

- !** If the front-passenger seat is unoccupied, do not insert the belt tongue into the buckle of the front-passenger seat. This may otherwise lead to the triggering of the Emergency Tensioning Device in the event of an accident, which will then need to be replaced.

Important safety notes

The use of seat belts and child restraint systems is required by law in:

- all 50 states
- the U.S. territories
- the District of Columbia
- all Canadian provinces

Even where this is not required by law, all vehicle occupants should correctly fasten their seat belts before starting the journey.

WARNING

If the seat belt is not worn correctly, it cannot perform its intended protective function. An incorrectly fastened seat belt can also cause

injuries, for example, in the event of an accident or when braking or changing direction abruptly. This poses an increased risk of injury or even fatal injury.

Always ensure that all vehicle occupants have their seat belts fastened correctly and are sitting properly.

WARNING

The seat belt does not offer the intended level of protection if you have not moved the backrest to an almost vertical position. When braking or in the event of an accident, you could slide underneath the seat belt and sustain abdomen or neck injuries, for example. This poses an increased risk of injury or even fatal injury.

Adjust the seat properly before beginning your journey. Always ensure that the backrest is in an almost vertical position and that the shoulder section of your seat belt is routed across the center of your shoulder.

WARNING

Persons less than 5 ft (1.50 m) tall cannot wear the seat belt correctly without an additional and suitable restraint system. If the seat belt is not worn correctly, it cannot perform its intended protective function. An incorrectly fastened seat belt can also cause injuries, for example, in the event of an accident or when braking or changing direction abruptly. This poses an increased risk of injury or even fatal injury.

For this reason, always secure persons under 5 ft (1.50 m) tall in suitable additional restraint systems.

If a child younger than twelve years old and under 5 ft (1.50 m) in height is traveling in the vehicle:

- always secure the child in a child restraint system suitable for this Mercedes-Benz vehicle. The child restraint system must be appropriate to the age, weight and size of the child
- always observe the instructions and safety notes on "Children in the vehicle" (> page 53) in addition to the child restraint

system manufacturer's installation and operating instructions

- always observe the instructions and safety notes on the "Occupant classification system (OCS)" (▷ page 46)

WARNING

The seat belts may not perform their intended protective function if:

- they are damaged, modified, extremely dirty, bleached or dyed
- the seat belt buckle is damaged or extremely dirty
- the Emergency Tensioning Devices, belt anchorages or inertia reels have been modified.

Seat belts may be damaged in an accident, although the damage may not be visible, e.g. due to splinters of glass. Modified or damaged seat belts may tear or fail, e.g. in an accident. Modified Emergency Tensioning Devices could accidentally trigger or fail to deploy when necessary. This poses an increased risk of injury or even fatal injury.

Never modify the seat belts, Emergency Tensioning Devices, belt anchorages and inertia reels. Make sure that the seat belts are undamaged, not worn out and clean. Following an accident, have the seat belts checked immediately at a qualified specialist workshop.

Only use seat belts that have been approved for your vehicle by Mercedes-Benz.

Sports seat or AMG Performance seat: this seat is designed for the standard three-point seat belt. If you install another multi-point seat belt, e.g. sport or racing seat belts, the restraint system cannot provide the best level of protection.

WARNING

If you feed seat belts through the opening in the seat backrest, the seat backrest may be damaged or may even break in the event of an accident. This poses an increased risk of injury or even fatal injury.

Only use the standard three-point seat belt. Never modify the seat belt system.

Proper use of the seat belts

Observe the safety notes on the seat belt (▷ page 41).

All vehicle occupants must be wearing the seat belt correctly before beginning the journey. Also make sure that all vehicle occupants are always wearing the seat belt correctly while the vehicle is in motion.

When fastening the seat belt, always make sure that:

- the seat belt tongue is only inserted to the belt buckle belonging to that seat.
- the seat belt is tight across your body. Avoid wearing bulky clothing, e.g. a winter coat.
- the seat belt is not twisted.

Only then can the forces which occur be distributed over the area of the belt.

- the shoulder section of the belt is always routed across the center of your shoulder.

The shoulder section of the belt must not come into contact with your neck or be routed under your arm. Where possible, adjust the seat belt to the appropriate height.

- the lap belt passes tightly and as low down as possible across your lap.

The lap belt must always be routed across your hip joints and not across your abdomen. This applies particularly to pregnant women. If necessary, push the lap belt down to your hip joint and pull it tight using the shoulder section of the belt.

- the seat belt is not routed across sharp, pointed or fragile objects.

If you have such items located on or in your clothing, e.g. pens, keys or eyeglasses, store these in a suitable place.

- only one person is using a seat belt at a time. Infants and children must never travel sitting on the lap of a vehicle occupant. In the event of an accident, they could be crushed between the vehicle occupant and seat belt.
- objects are never secured with a seat belt if the seat belt is also being used by one of the vehicle's occupants.

Also ensure that there are never objects between a person and the seat, e.g. cushions.

Seat belts are only intended to secure and restrain vehicle occupants. Always observe the "Loading guidelines" for securing objects, luggage or loads (▷ page 233).

Fastening and adjusting the seat belts

Observe the safety notes on the seat belt (▷ page 41) and the notes on correct use of seat belts (▷ page 42).

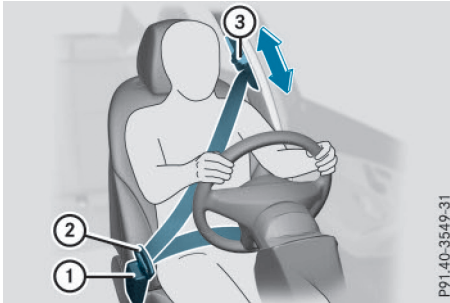

Basic illustration

- ▶ Adjust the seat (▷ page 89).
The seat backrest must be in an almost vertical position.
- ▶ Pull the seat belt smoothly from the belt outlet.
- ▶ Engage seat belt tongue ② in belt buckle ①.
- ▶ If necessary, pull upwards on the shoulder section of the seat belt to tighten the belt across your body.

The shoulder section of the seat belt must always be routed across the center of the shoulder. Adjust the belt outlet if necessary.

- ▶ **To raise:** slide the belt outlet upwards.
The belt outlet will engage in various positions.
- ▶ **To lower:** hold belt outlet release ③ and slide belt outlet downwards.
- ▶ Let go of belt outlet release ③ in the desired position and make sure that the belt outlet engages.

All seat belts except the driver's seat belt are equipped with a special seat belt retractor to securely fasten child restraint systems in the vehicle. Further information can be found under "Special seat belt retractor" (▷ page 54).



Releasing seat belts

❗ Make sure that the seat belt is fully rolled up. Otherwise, the seat belt or belt tongue will be trapped in the door or in the seat mechanism. This could damage the door, the door trim panel and the seat belt. Damaged seat belts can no longer fulfill their protective function and must be replaced. Visit a qualified specialist workshop.

- ▶ Press the release button in the belt buckle, hold the belt tongue firmly and guide the belt back.

Belt warning for the driver and front passenger

The  seat belt warning lamp in the instrument cluster is a reminder that all vehicle occupants must wear their seat belts. It may light up continuously or flash. In addition, there may be a warning tone.

Regardless of whether the driver's seat belt has already been fastened, the  seat belt warning lamp lights up for six seconds each time the engine is started. If, after six seconds, the driver or front-passenger seat belt has not been fastened and the doors are closed, the  seat belt warning lamp lights up. As soon as the driver's and front-passenger seat belts are fastened or a front door is opened again, the  seat belt warning lamp goes out.

If the driver's seat belt is not fastened after the engine is started, an additional warning tone will sound. The warning tone switches off after six seconds or once the driver's seat belt is fastened.

If the vehicle's speed exceeds 15 mph (25 km/h) once and the driver's and front-passenger seat belts are not fastened, a warning tone sounds. A warning tone also sounds with increasing intensity for 60 seconds or until the driver or front passenger have fastened their seat belts.

If the driver or front passenger unfasten their seat belts during the journey, the seat belt warning is activated again.

Air bags

Introduction

The installation point of an air bag can be recognized by the AIR BAG symbol.

An air bag complements the correctly fastened seat belt. It is no substitute for the seat belt. The air bag provides additional protection in applicable accident situations.

Not all air bags are deployed in an accident. The different air bag systems function independently from one another (▷ page 51).

However, no system available today can completely eliminate injuries and fatalities.

It is also not possible to rule out a risk of injury caused by an air bag due to the high speed at which the air bag must be deployed.

Important safety notes

WARNING

If you do not sit in the correct seat position, the air bag cannot protect as intended and could even cause additional injury when deployed. This poses an increased risk of injury or even fatal injury.

To avoid hazardous situations, always make sure that all of the vehicle's occupants:

- have fastened their seat belts correctly, including pregnant women
- are sitting correctly and maintain the greatest possible distance to the air bags
- follow the following instructions

Always make sure that there are no objects between the air bag and the vehicle's occupants.

- Adjust the seats properly before beginning your journey. Always make sure that the seat is in an almost upright position. The center of the head restraint must support the head at about eye level.
- Move the driver's and front-passenger seats as far back as possible. The driver's seat position must allow the vehicle to be driven safely.
- Only hold the steering wheel on the outside. This allows the air bag to be fully deployed.
- Always lean against the backrest while driving. Do not lean forwards or lean against the

door or side window. You may otherwise be in the deployment area of the air bags.

- Always keep your feet in the footwell in front of the seat. Do not put your feet on the dashboard, for example. Your feet may otherwise be in the deployment area of the air bag.
- For this reason, always secure persons less than 5 ft (1.50 m) tall in suitable restraint systems. Up to this height, the seat belt cannot be worn correctly.

If a child is traveling in your vehicle, also observe the following notes:

- Always secure children under twelve years of age and less than 5 ft (1.50 m) tall in suitable child restraint systems.
- Child restraint systems should be installed on the rear seats.
- Only secure a child in a rearward-facing child restraint system on the front-passenger seat when the front-passenger front air bag is deactivated. If the PASSENGER AIR BAG OFF indicator lamp is permanently lit, the front-passenger front air bag is deactivated (▷ page 40).
- Always observe the instructions and safety notes on the "Occupant Classification System (OCS)" (▷ page 46) and on "Children in the vehicle" (▷ page 53) in addition to the child restraint system manufacturer's installation and operating instructions.

Objects in the vehicle interior may prevent an air bag from functioning correctly. Before starting your journey and to avoid risks resulting from the speed of the air bag as it deploys, make sure that:

- there are no people, animals or objects between the vehicle occupants and an air bag.
- there are no objects between the seat, door and B-pillar.
- no hard objects, e.g. coat hangers, hang on the grab handles or coat hooks.
- no accessories, such as cup holders, are attached to the vehicle within the deployment area of an air bag, e.g. to doors, side windows, rear side trim or side walls.
- no heavy, sharp-edged or fragile objects are in the pockets of your clothing. Store such objects in a suitable place.

⚠ WARNING

If you modify the air bag cover or affix objects such as stickers to it, the air bag can no longer function correctly. There is an increased risk of injury.

Never modify an air bag cover or affix objects to it.

⚠ WARNING

Sensors to control the air bags are located in the doors. Modifications or work not performed correctly to the doors or door paneling, as well as damaged doors, can lead to the function of the sensors being impaired. The air bags might therefore not function properly anymore. Consequently, the air bags cannot protect vehicle occupants as they are designed to do. There is an increased risk of injury.

Never modify the doors or parts of the doors. Always have work on the doors or door paneling carried out at a qualified specialist workshop.

Front air bags

! Do not place heavy objects on the front-passenger seat. This could cause the system to identify the seat as being occupied. In the event of an accident, the restraint systems on the front-passenger side may be triggered and have to be replaced.

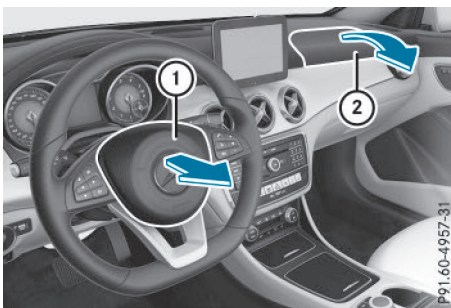

Driver's air bag ① deploys in front of the steering wheel. Front-passenger front air bag ② deploys in front of and above the glove box.

When deployed, the front air bags offer additional head and thorax protection for the occupants in the front seats.

The PASSENGER AIR BAG OFF indicator lamp informs you about the status of the front-passenger front air bag (▷ page 40).

The front-passenger front air bag will only deploy if:

- the system, based on the OCS weight sensor readings, detects that the front-passenger seat is occupied (▷ page 46). The PASSENGER AIR BAG OFF indicator lamp is not lit (▷ page 47)
- the restraint system control unit predicts a high accident severity

Knee bags

Driver's knee bag ① deploys under the steering column and front-passenger knee bag ② under the glove box. The driver's and front-passenger knee bags are triggered together with the front air bags.

The driver's and front-passenger knee bags offer additional thigh, knee and lower leg protection for the occupants in the front seats.

Side impact air bags**⚠ WARNING**

Unsuitable seat covers can obstruct or prevent deployment of the air bags integrated into the seats. Consequently, the air bags cannot protect vehicle occupants as they are designed to do. In addition, the operation of the occupant classification system (OCS) could be adversely affected. This poses an increased risk of injury or even fatal injury.

You should only use seat covers that have been approved for the respective seat by Mercedes-Benz.

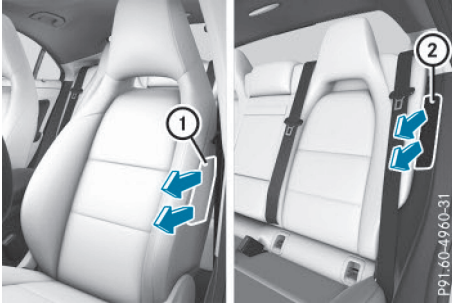

Front side impact air bags ① and rear side impact air bags ② deploy next to the outer bolster of the seat backrest.

When deployed, the side impact air bag offers additional thorax protection. It also offers additional pelvis protection for occupants in the front seats. However, it does not protect the:

- head
- neck
- arms

In the event of a side impact, the side impact air bag is deployed on the side on which the impact occurs.

The side impact air bag on the front-passenger side deploys under the following conditions:

- the OCS system detects that the front-passenger seat is occupied or
- the seat belt buckle tongue is engaged in the belt buckle of the front-passenger seat

If the belt tongue is engaged in the belt buckle, the side impact air bag on the front-passenger side deploys if an appropriate accident situation occurs. In this case, deployment is independent of whether the front-passenger seat is occupied or not.

Window curtain air bags

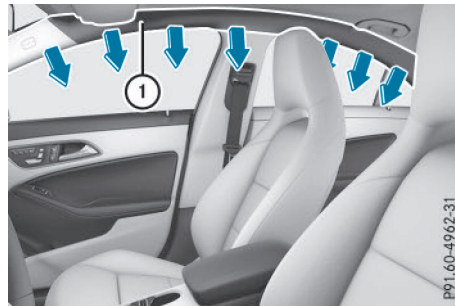

Window curtain air bags ① are integrated into the side of the roof frame and deployed in the area from the A-pillar to the C-pillar.

When deployed, the window curtain air bag enhances the level of protection for the head. However, it does not protect the chest or arms.

In the event of a side impact, the window curtain air bag is deployed on the side on which the impact occurs.

If the system determines that they can offer additional protection to that provided by the seat belt, a window curtain air bag may be deployed in other accident situations (> page 51).

Occupant Classification System (OCS)

Introduction

The Occupant Classification System (OCS) categorizes the person in the front-passenger seat. Depending on that result, the front-passenger front air bag and front-passenger knee bag are either enabled or deactivated.

The system does not deactivate:

- the side impact air bag
- the window curtain air bag
- the Emergency Tensioning Devices

Requirements

To be classified correctly, the front passenger must sit:

- with the seat belt fastened correctly
 - in an almost upright position with their back against the seat backrest
 - with their feet resting on the floor, if possible
- If the front passenger does not observe these conditions, OCS may produce a false classification, e.g. because the front passenger:
- transfers their weight by supporting themselves on a vehicle armrest
 - sits in such a way that their weight is raised from the seat cushion

If it is absolutely necessary to install a child restraint system on the front-passenger seat, be sure to observe the correct positioning of the child restraint system. Never place objects under or behind the child restraint system, e.g. a cushion. The entire base of the child restraint system must always rest on the seat cushion of the front-passenger seat. The backrest of the forward-facing child restraint system must lie as flat as possible against the backrest of the front-passenger seat.

The child restraint system must not touch the roof or be subjected to a load by the head restraint. Adjust the angle of the seat backrest and the head restraint position accordingly.

Only then can OCS be guaranteed to function correctly. Always observe the child restraint system manufacturer's installation and operating instructions.

Operation of Occupant Classification System (OCS)



- ① PASSENGER AIR BAG ON indicator lamp
- ② PASSENGER AIR BAG OFF indicator lamp

The indicator lamps inform you whether the front-passenger front air bag is deactivated or enabled.

- ▶ Press the Start/Stop button once or twice, or turn the SmartKey to position **1** or **2** in the ignition lock.
The system carries out self-diagnostics.

The PASSENGER AIR BAG OFF and PASSENGER AIR BAG ON indicator lamps must light up simultaneously for approximately six seconds.

The indicator lamps display the status of the front-passenger front air bag.

- PASSENGER AIR BAG ON lights up for 60 seconds, subsequently both indicator lamps are off (PASSENGER AIR BAG ON and OFF): the front-passenger front air bag is able to deploy in the event of an accident.
- PASSENGER AIR BAG OFF lights up: the front-passenger front air bag is deactivated. It will then not be deployed in the event of an accident.

If the PASSENGER AIR BAG ON indicator lamp is off, only the PASSENGER AIR BAG OFF indicator lamp shows the status of the front-passenger front air bag. The PASSENGER AIR BAG OFF indicator lamp may be lit continuously or be off.

If the status of the front-passenger front air bag changes while the vehicle is in motion, an air bag display message appears in the instrument cluster (> page 197). When the front-passenger seat is occupied, always pay attention to the PASSENGER AIR BAG OFF indicator lamp. Be aware of the status of the front-passenger front air bag both before and during the journey.

WARNING

If the PASSENGER AIR BAG OFF indicator lamp is lit, the front-passenger front air bag is disabled. It will not be deployed in the event of an accident and cannot perform its intended protective function. A person in the front-passenger seat could then, for example, come into contact with the vehicle's interior, especially if the person is sitting too close to the dashboard. This poses an increased risk of injury or even fatal injury.

When the front-passenger seat is occupied, always ensure that:

- the classification of the person in the front-passenger seat is correct and the front-

passenger front air bag is enabled or disabled in accordance with the person in the front-passenger seat

- the front-passenger seat has been moved back as far back as possible.
- the person is seated correctly.

Make sure, both before and during the journey, that the status of the front-passenger front air bag is correct.

WARNING

If you secure a child in a rearward-facing child restraint system on the front-passenger seat and the PASSENGER AIR BAG OFF indicator lamp is off, the front-passenger front air bag may deploy in the event of an accident. The child could be struck by the air bag. This poses an increased risk of injury or even fatal injury. Make sure that the front-passenger front air bag has been disabled. The PASSENGER AIR BAG OFF indicator lamp must be lit.

If the PASSENGER AIR BAG OFF indicator lamp stays off, do not install a rearward-facing child restraint system on the front-passenger seat. You can find more information on OCS under "Problems with the Occupant Classification System" (▷ page 50).

WARNING

If you secure a child in a forward-facing child restraint system on the front-passenger seat and you position the front-passenger seat too close to the dashboard, in the event of an accident, the child could:

- come into contact with the vehicle's interior if the PASSENGER AIR BAG OFF indicator lamp is lit, for example
- be struck by the air bag if the PASSENGER AIR BAG OFF indicator lamp is off

This poses an increased risk of injury or even fatal injury.

Always move the front-passenger seat as far back as possible and fully retract the seat cushion length. Always make sure that the shoulder belt strap is correctly routed from the vehicle belt sash guide to the shoulder

belt guide on the child restraint system. The shoulder belt strap must be routed forwards and downwards from the vehicle belt sash guide. If necessary, adjust the vehicle belt sash guide and the front-passenger seat accordingly. Always observe the child restraint system manufacturer's installation instructions.

If OCS determines that:

- the front-passenger seat is unoccupied, the PASSENGER AIR BAG OFF indicator lamp lights up after the system self-test and remains lit. This indicates that the front-passenger front air bag is deactivated.
- the front-passenger seat is occupied by a child of up to twelve months old, in a standard child restraint system, the PASSENGER AIR BAG OFF indicator lamp lights up after the system self-test and remains lit. This indicates that the front-passenger front air bag is deactivated.

But even in the case of a twelve-month-old child, in a standard child restraint system, the PASSENGER AIR BAG OFF indicator lamp can go out after the system self-test. This indicates that the front-passenger front air bag is activated. The result of the classification is dependent on, among other factors, the child restraint system and the child's stature. It is recommended that you install the child restraint system on a suitable rear seat.

- the front-passenger seat is occupied by a person of smaller stature (e.g. a teenager or small adult), the PASSENGER AIR BAG OFF indicator lamp lights up and remains lit after the system self-test depending on the result of the classification or, alternatively, goes out.
 - If the PASSENGER AIR BAG OFF indicator lamp is off, move the front-passenger seat as far back as possible. Alternatively, a person of smaller stature can sit on a rear seat.
 - If the PASSENGER AIR BAG OFF indicator lamp is lit, a person of smaller stature should not use the front-passenger seat.
- the front-passenger seat is occupied by an adult or a person of adult stature, the PASSENGER AIR BAG OFF indicator lamp goes out after the system self-test. This indicates that the front-passenger front air bag is activated.

If children are traveling in the vehicle, be sure to observe the notes on "Children in the vehicle" (▷ page 53).

When the occupant classification system (OCS) is malfunctioning, the red  restraint system warning lamp in the instrument cluster and the PASSENGER AIR BAG OFF indicator lamp light up simultaneously. The front-passenger front air bag is deactivated in this case and does not deploy during an accident. Have the Occupant Classification System (OCS) checked and repaired immediately at a qualified specialist workshop. Mercedes-Benz recommends that you use an authorized Mercedes-Benz Center for this purpose.

If the front-passenger seat, the seat cover or the seat cushion are damaged, have the necessary repair work carried out at a qualified specialist workshop. Mercedes-Benz recommends that you use an authorized Mercedes-Benz Center for this purpose.

For safety reasons, Mercedes-Benz recommends that you only use seat accessories that have been approved by Mercedes-Benz.

If the driver's air bag deploys, this does not mean that the front-passenger front air bag will also deploy. The Occupant Classification System (OCS) categorizes the occupant in the front-passenger seat. Depending on that result, the front-passenger front air bag is either enabled or deactivated.

System self-test

DANGER

If both the PASSENGER AIR BAG OFF and PASSENGER AIR BAG ON indicator lamps do not light up during the system self-test, the system is malfunctioning. The front-passenger front air bag might be triggered unintentionally or might not be triggered at all in the event of an accident with high deceleration. This poses an increased risk of injury or even fatal injury.

In this case the front-passenger seat may not be used. Do not install a child restraint system on the front-passenger seat. Have the Occupant Classification System (OCS) checked and repaired immediately at a qualified specialist workshop.

WARNING

If the PASSENGER AIR BAG OFF indicator lamp remains lit after the system self-test, the front-passenger front air bag is disabled. It will not be deployed in the event of an accident. In this case, the front-passenger front air bag cannot perform its intended protective function, e.g. when a person is seated in the front-passenger seat.

That person could, for example, come into contact with the vehicle's interior, especially if the person is sitting too close to the dashboard. This poses an increased risk of injury or even fatal injury.

When the front-passenger seat is occupied, always ensure that:

- the classification of the person in the front-passenger seat is correct and the front-passenger front air bag is enabled or disabled in accordance with the person in the front-passenger seat
- the person is seated properly with a correctly fastened seatbelt
- the front-passenger seat has been moved as far back as possible

If the PASSENGER AIR BAG OFF indicator lamp remains lit when it should not, the front-passenger seat may not be used. Do not install a child restraint system on the front-passenger seat. Have the Occupant Classification System (OCS) checked and repaired immediately at a qualified specialist workshop.

WARNING

Objects between the seat surface and the child restraint system could affect OCS operation. This could result in the front-passenger air bag not functioning as intended during an accident. This poses an increased risk of injury or even fatal injury.

Do not place any objects between the seat surface and the child restraint system. The entire base of the child restraint system must always rest on the seat cushion of the front-passenger seat. The backrest of the forward-

facing child restraint system must, as far as possible, be resting on the backrest of the front-passenger seat. Always comply with the child restraint system manufacturer's installation instructions.

After the system self-test, the PASSENGER AIR BAG OFF or PASSENGER AIR BAG ON indicator lamp displays the status of the front-passenger front air bag (▷ page 47). If the front-passenger front air bag is enabled, the PASSENGER AIR

BAG ON indicator lamp lights up for 60 seconds and then goes out.

If the PASSENGER AIR BAG ON indicator lamp is off, only the PASSENGER AIR BAG OFF indicator lamp shows the status of the front-passenger front air bag. The PASSENGER AIR BAG OFF indicator lamp may be lit continuously or be off. For more information about the OCS, see "Problems with the Occupant Classification System" (▷ page 50).

Problems with the Occupant Classification System (OCS)

Be sure to observe the notes on "System self-test" (▷ page 49).

Problem	Possible causes/consequences and ► Solutions
<p>The PASSENGER AIR BAG OFF indicator lamp lights up and remains lit, even though the front-passenger seat is occupied by an adult or a person of a stature corresponding to that of an adult.</p>	<p>The classification of the person on the front-passenger seat is incorrect.</p> <ul style="list-style-type: none"> ► Make sure the conditions for a correct classification of the person on the front-passenger seat are met (▷ page 47). ► If the PASSENGER AIR BAG OFF indicator lamp remains lit, the front-passenger seat may not be used. ► Have OCS checked as soon as possible at an authorized Mercedes-Benz Center.
<p>The PASSENGER AIR BAG OFF indicator lamp does not light up and/or does not stay on.</p> <p>The front-passenger seat is:</p> <ul style="list-style-type: none"> • unoccupied • occupied with the weight of a child up to twelve months old in a child restraint system 	<p>OCS is malfunctioning.</p> <ul style="list-style-type: none"> ► Make sure there is nothing between the seat cushion and the child seat. ► Make sure that the entire base of the child restraint system rests on the seat cushion of the front-passenger seat. The backrest of the forward-facing child restraint system must lie as flat as possible against the backrest of the front-passenger seat. If necessary, adjust the position of the front-passenger seat. ► Make sure that the seat cushion length is fully retracted. ► When installing the child restraint system, make sure that the seat belt is tight. Do not pull the seat belt tight using the front-passenger seat adjustment. This could result in the seat belt and the child restraint system being pulled too tightly. ► Check for correct installation of the child restraint system. Make sure that the head restraint does not apply a load to the child restraint system. If necessary, adjust the head restraint accordingly. ► Make sure that no objects are applying additional weight onto the seat. ► If the PASSENGER AIR BAG OFF indicator lamp remains off and/or the PASSENGER AIR BAG ON indicator lamp lights up, do not install a child restraint system on the front-passenger seat. It is recommended that you install the child restraint system on a suitable rear seat. ► Have OCS checked as soon as possible at an authorized Mercedes-Benz Center.

Deployment of Emergency Tensioning Devices and air bags

Important safety notes

WARNING

The air bag parts are hot after an air bag has been deployed. There is a risk of injury. Do not touch the air bag parts. Have a deployed air bag replaced at a qualified specialist workshop as soon as possible.

WARNING

A deployed air bag no longer offers any protection and cannot provide the intended protection in an accident. There is an increased risk of injury.

Have the vehicle towed to a qualified specialist workshop in order to have a deployed air bag replaced.

It is important for your safety and that of your passenger to have deployed air bags replaced

and to have any malfunctioning air bags repaired. This will help to make sure the air bags continue to perform their protective function for the vehicle occupants in the event of a crash.

WARNING

Emergency Tensioning Devices that have deployed pyrotechnically are no longer operational and are unable to perform their intended protective function. This poses an increased risk of injury or even fatal injury.

Have pyrotechnically triggered Emergency Tensioning Devices replaced immediately at a qualified specialist workshop.

If Emergency Tensioning Devices are triggered or air bags are deployed, you will hear a bang, and a small amount of powder may also be released. The  restraint system warning lamp lights up.

Only in rare cases will the bang affect your hearing. The powder that is released generally does not constitute a health hazard, but it may cause short-term breathing difficulties in people with asthma or other respiratory problems. Provided it is safe to do so, you should leave the vehicle immediately or open the window in order to prevent breathing difficulties.

Air bags and pyrotechnic Emergency Tensioning Devices (ETDs) contain perchlorate material, which may require special handling and regard for the environment. National guidelines must be observed during disposal. In California, see www.dtsc.ca.gov/HazardousWaste/Perchlorate/index.cfm.

Method of operation

During the first stage of a collision, the restraint system control unit evaluates important physical data relating to vehicle deceleration or acceleration, such as:

- duration
- direction
- intensity

Based on the evaluation of this data, the restraint system control unit triggers the Emergency Tensioning Devices during a frontal or rear collision.

An Emergency Tensioning Device can only be triggered, if:

- the ignition is switched on
- the components of the restraint system are operational. You can find further information under: "Restraint system warning lamp" (▷ page 40)
- the seat belt buckle tongue has engaged in the belt buckle of the respective front seat

The Emergency Tensioning Devices in the rear compartment are triggered independently of the lock status of the seat belts.

If the restraint system control unit detects a more severe accident, further components of the restraint system are activated independently of each other in certain frontal collision situations:

- Front air bags as well as driver's and front-passenger knee bags
- Window curtain air bag, if the system determines that deployment can offer additional protection to that provided by the seat belt

The front-passenger front air bag is activated or deactivated depending on the person on the front-passenger seat. The front-passenger front air bag can only deploy in an accident if the PASSENGER AIR BAG OFF indicator lamp is off. Observe the information on the PASSENGER AIR BAG indicator lamps (▷ page 40).

Your vehicle has two-stage front air bags. During the first deployment stage, the front air bag is filled with propellant gas to reduce the risk of injuries. The front air bag is fully deployed with the maximum amount of propellant gas if a second deployment threshold is reached within a few milliseconds.

The activation threshold of the Emergency Tensioning Devices and the air bag are determined by evaluating the rate of vehicle deceleration or acceleration which occurs at various points in the vehicle. This process is pre-emptive in nature. Deployment should take place in good time at the start of the collision.

The rate of vehicle deceleration or acceleration and the direction of the force are essentially determined by:

- the distribution of forces during the collision
- the collision angle
- the deformation characteristics of the vehicle
- the characteristics of the object with which the vehicle has collided

Factors which can only be seen and measured after a collision has occurred do not play a decisive role in the deployment of an air bag. Nor do they provide an indication of air bag deployment.

The vehicle can be deformed considerably, without an air bag being deployed. This is the case if only parts which are relatively easily deformed are affected and the rate of deceleration is not high. Conversely, air bags may be deployed even though the vehicle suffers only minor deformation. This is the case if, for example, very rigid vehicle parts such as longitudinal body members are hit, and sufficient deceleration occurs as a result.

If the restraint system control unit detects a side impact or if the vehicle rolls over, the applicable components of the restraint system are activated independently of each other depending on the apparent type of accident.

- Side impact air bags on the side where the impact takes place, independently of the Emergency Tensioning Device and the use of the seat belt on the driver's seat and outer seats in the second row

The side impact air bag on the front-passenger side deploys under the following conditions:

- the OCS system detects that the front-passenger seat is occupied or
- the seat belt buckle tongue is engaged in the belt buckle of the front-passenger seat
- Window curtain air bag on the side of impact, independently of the use of the seat belt and independently of whether the front-passenger seat is occupied
- Emergency Tensioning Devices, if the system determines that deployment can offer additional protection in this situation
- Window curtain air bags on the driver's and front-passenger side in certain situations when the vehicle rolls over, if the system determines that deployment can offer additional protection to that provided by the seat belt

i Not all air bags are deployed in an accident. The different air bag systems work independently of each other.

How the air bag system works is determined by the severity of the accident detected, especially the vehicle deceleration or acceleration and the apparent type of accident:

- Frontal collision
- Side impact
- Rollover

Automatic measures after an accident

Immediately after an accident, the following measures are implemented, depending on the type and severity of the impact:

- the hazard warning lamps are activated
- the emergency lighting is activated
- the vehicle doors are unlocked
- the front side windows are lowered
- the engine is switched off and the fuel supply is cut off
- vehicles with mbrace: automatic emergency call

Children in the vehicle

Important safety notes

Accident statistics show that children secured in the rear seats are safer than children secured in the front-passenger seat. For this reason, Mercedes-Benz strongly advises that you install a child restraint system on a rear seat. Children are generally better protected there.

If a child younger than twelve years old and under 5 ft (1.50 m) in height is traveling in the vehicle:

- always secure the child in a child restraint system suitable for Mercedes-Benz vehicles. The child restraint system must be appropriate to the age, weight and size of the child
- be sure to observe the instructions and safety notes in this section in addition to the child restraint system manufacturer's installation instructions
- be sure to observe the instructions and safety notes on the "Occupant classification system (OCS)" (▷ page 46)

⚠ WARNING

If you leave children unsupervised in the vehicle, they could set it in motion by, for example:

- release the parking brake.
- shift the automatic transmission out of the parking position **P**.
- start the engine.

In addition, they may operate vehicle equipment and become trapped. There is a risk of an accident and injury.

When leaving the vehicle, always take the SmartKey with you and lock the vehicle. Never leave children unsupervised in the vehicle.

⚠ WARNING

If persons, particularly children are subjected to prolonged exposure to extreme heat or cold, there is a risk of injury, possibly even fatal. Never leave children unattended in the vehicle.

⚠ WARNING

If the child restraint system is subjected to direct sunlight, parts may get very hot. Children may burn themselves on these parts, particularly on the metal parts of the child restraint system. There is a risk of injury.

If you leave the vehicle, taking the child with you, always ensure that the child restraint system is not exposed to direct sunlight. Protect it with a blanket, for example. If the child restraint system has been exposed to direct sunlight, let it cool down before securing the child in it. Never leave children unattended in the vehicle.

Always ensure that all vehicle occupants have their seat belts fastened correctly and are sitting properly. Particular attention must be paid to children.

Observe the safety notes on the seat belt (> page 41) and the notes on correct use of seat belts (> page 42).

A booster seat may be necessary to achieve proper seat belt positioning for children over 41 lbs (18 kg) until they reach a height where a

three-point seat belt can be properly fastened without a booster seat.

Special seat belt retractor**⚠ WARNING**

If the seat belt is released while driving, the child restraint system will no longer be secured properly. The special seat belt retractor is disabled and the inertia reel draws in a portion of the seat belt. The seat belt cannot be immediately refastened. There is an increased risk of injury, possibly even fatal.

Stop the vehicle immediately, paying attention to road and traffic conditions. Reactivate the special seat belt retractor and secure the child restraint system properly.

All seat belts except the driver's seat belt are equipped with a special seat belt retractor. When activated, the special seat belt retractor ensures that the seat belt will not slacken once the child restraint system has been secured.

Installing a child restraint system:

- ▶ Always comply with the child restraint system manufacturer's installation instructions.
- ▶ Pull the seat belt smoothly from the belt outlet.
- ▶ Engage the seat belt tongue in the belt buckle.

Activating the special seat belt retractor:

- ▶ Pull the seat belt out fully and let the inertia reel retract it again.
While the seat belt is retracting, you should hear a ratcheting sound. The special seat belt retractor is activated.
- ▶ Push the child seat restraint system down so that the seat belt is tight and does not loosen.

Removing a child restraint system and deactivating the special seat belt retractor:

- ▶ Always comply with the child restraint system manufacturer's installation instructions.
- ▶ Press the release button of the belt buckle, hold the belt tongue firmly and guide it back towards the belt outlet.
The special seat belt retractor is deactivated.

Child restraint system

The use of seat belts and child restraint systems is required by law in:

- all 50 states
- the U.S. territories
- the District of Columbia
- all Canadian provinces

If you install a rearward-facing child restraint system on the center rear seat, the rear arm rest must be folded back as far as possible.

You can obtain further information about the correct child restraint system from any authorized Mercedes-Benz Center.

WARNING

If the child restraint system is installed incorrectly on a suitable seat, it cannot protect as intended. The child cannot then be restrained in the event of an accident, heavy braking or sudden changes of direction. There is an increased risk of injury, possibly even fatal.

Make sure that you observe the child restraint system manufacturer's installation instructions and the notes on use. Please ensure, that the base of the child restraint system is always resting completely on the seat cushion. Never place objects, e.g. cushions, under or behind the child restraint system. Only use child restraint systems with the original cover designed for them. Only replace damaged covers with genuine covers.

WARNING

If the child restraint system is installed incorrectly or is not secured, it can come loose in the event of an accident, heavy braking or a sudden change in direction. The child restraint system could be thrown about, striking vehicle occupants. There is an increased risk of injury, possibly even fatal.

Always install child restraint systems properly, even if they are not being used. Make sure that you observe the child restraint system manufacturer's installation instructions.

You will find further information on stowing objects, luggage or loads under "Loading guidelines" (▷ page 233).

WARNING

Child restraint systems or their securing systems which have been damaged or subjected to a load in an accident can no longer protect as intended. The child cannot then be restrained in the event of an accident, heavy braking or sudden changes of direction. There is an increased risk of injury, possibly even fatal.

Replace child restraint systems which have been damaged or subjected to a load in an accident as soon as possible. Have the securing systems on the child restraint system checked at a qualified specialist workshop, before you install a child restraint system again.

The securing systems of child restraint systems are:

- the seat belt system
- the LATCH-type (ISOFIX) securing rings
- the Top Tether anchorages

If it is absolutely necessary to carry a child on the front-passenger seat, be sure to observe the information on the "Occupant Classification System (OCS)" (▷ page 46). There you will also find information on deactivating the front-passenger front air bag.

All child restraint systems must meet the following standards:

- U.S. Federal Motor Vehicle Safety Standards 213 and 225
- Canadian Motor Vehicle Safety Standards 213 and 210.2

Confirmation that the child restraint system corresponds to the standards can be found on an instruction label on the child restraint system. This confirmation can also be found in the installation instructions that are included with the child restraint system.

Observe the warning labels in the vehicle interior and on the child restraint system.

LATCH-type (ISOFIX) child seat securing system

WARNING

LATCH-type (ISOFIX) child restraint systems do not offer sufficient protective effect for children whose weight is greater than 48 lbs (22 kg) who are secured using the safety belt integrated in the child restraint system. In the event of an accident, a child might not be restrained correctly. This poses an increased risk of injury or even fatal injury.

If the child weighs more than 48 lbs (22 kg), only use LATCH-type (ISOFIX) child restraint systems with which the child is also secured with the vehicle seat belt. Also secure the child restraint system with the Top Tether belt, if available.

Always comply with the manufacturer's installation and operating instructions for the child restraint system used.

Before every trip, make sure that the LATCH-type (ISOFIX) child restraint system is engaged correctly in both LATCH-type (ISOFIX) securing rings

- ! When installing the child restraint system, make sure that the seat belt for the middle seat does not get trapped. The seat belt could otherwise be damaged.

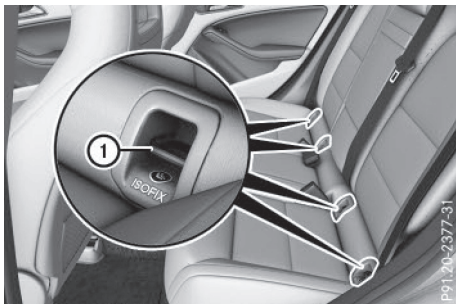

- Install the LATCH-type (ISOFIX) child restraint system on both LATCH-type (ISOFIX) securing rings ①.

ISOFIX is a standardized securing system for specially designed child restraint systems on the rear seats. LATCH-type (ISOFIX) securing rings for two LATCH-type (ISOFIX) child restraint

systems are installed on the left and right of the rear seats.

Non-LATCH-type (ISOFIX) child seats may also be used and can be installed using the vehicle's seat belt system. Install the child seat according to the manufacturer's instructions.

Top Tether

Introduction

Top Tether provides an additional connection between the child restraint system secured with a LATCH-type (ISOFIX) system and the vehicle. This helps reduce the risk of injury even further. If the child restraint system is equipped with a Top Tether belt, this should always be used.

Important safety notes

WARNING

If the rear seat backrests are not locked, they could fold forwards in the event of an accident, heavy braking or sudden changes of direction. As a result, child restraint systems cannot perform their intended protective function. Rear seat backrests that are not locked can also cause additional injuries, e.g. in the event of an accident. This poses an increased risk of injury or even fatal injury.

Always lock rear seat backrests after installing a Top Tether belt. Observe the lock verification indicator. Adjust the rear seat backrests so that they are in an upright position.

If the rear backrest is not engaged and locked, the red lock verification indicator will be visible (▷ page 236).

Top Tether anchorages

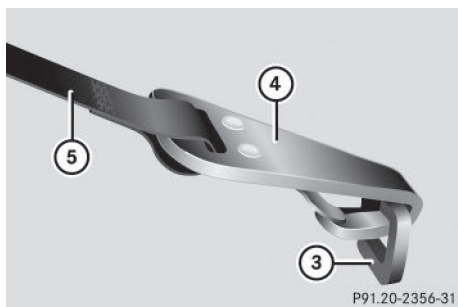
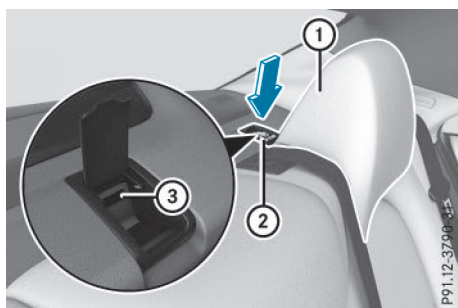

The Top Tether anchorage points are installed in the rear compartment behind the head restraints on the parcel shelf.

- ▶ Press down the rear of cover (2) in the direction of the arrow.
Cover (2) is raised slightly at the front.
- ▶ Fold cover (2) upwards.

Vehicles with adjustable head restraints:

- ▶ Move head restraint (1) upwards.
- ▶ Route Top Tether belt (5) under head restraint (1) between the two head restraint bars.

Vehicles without adjustable head restraints:

- ▶ **Top Tether belt with one belt strap:** route Top Tether belt (5) centrally over head restraint (1).

or

- ▶ **Top Tether belt with two belt straps:** route one Top Tether belt (5) to the left and one to the right past the side of head restraint (1).

All vehicles:

- ▶ Install the LATCH-type (ISOFIX) child restraint system with Top Tether. Always comply with

the child restraint system manufacturer's installation instructions when doing so.

- ▶ Hook Top Tether hook (4) of Top Tether belt (5) into Top Tether anchorage (3).

Make sure that:

- Top Tether hook (4) is hooked into Top Tether anchorage (3) as shown.
- Top Tether belt (5) is not twisted.
- Top Tether belt (5) is routed between the rear seat backrest and the cargo compartment cover if the cargo compartment cover is installed.

- ▶ Tension Top Tether belt (5). Always comply with the child restraint system manufacturer's installation instructions when doing so.

Vehicles with adjustable head restraints:

- ▶ If necessary, move head restraint (1) back down again slightly. Make sure that you do not interfere with the correct routing of Top Tether belt (5).

Child restraint system on the front-passenger seat

General notes

Accident statistics show that children secured in the rear seats are safer than children secured in the front-passenger seat. For this reason, Mercedes-Benz strongly advises that you install the child restraint system on a rear seat.

If it is absolutely necessary to install a child restraint system on the front-passenger seat, always observe the instructions and safety notes on the "Occupant Classification System (OCS)" (> page 46).

You can thus avoid the risks that could arise as a result of:

- an incorrectly categorized person in the front-passenger seat
- the unintentional deactivation of the front-passenger front air bag
- the unsuitable positioning of the child restraint system, e.g. too close to the dashboard

Rearward-facing child restraint system

If it is absolutely necessary to install a rearward-facing child restraint system on the front-passenger seat, always make sure that the front-passenger front air bag is deactivated. Only if the PASSENGER AIR BAG OFF indicator lamp is permanently lit (▷ page 40) is the front-passenger front air bag deactivated.

Always observe the child restraint system manufacturer's installation and operating instructions.

Forward-facing child restraint system

If it is absolutely necessary to install a forward-facing child restraint system on the front-passenger seat, always move the front-passenger seat as far back as possible. Fully retract the seat cushion length. The entire base of the child restraint system must always rest on the seat cushion of the front-passenger seat. The backrest of the child restraint system must lie as flat as possible against the backrest of the front-passenger seat. The child restraint system must not touch the roof or be subjected to a load by the head restraint. Adjust the angle of the seat backrest and the head restraint position accordingly. Always make sure that the shoulder belt strap is correctly routed from the vehicle belt outlet to the shoulder belt guide on the child restraint system. The shoulder belt strap must be routed forwards and downwards from the vehicle belt outlet. If necessary, adjust the vehicle belt outlet and the front-passenger seat accordingly.

Always observe the child restraint system manufacturer's installation and operating instructions.

Child-proof locks

Important safety notes

WARNING

If children are traveling in the vehicle, they could:

- open doors, thus endangering other people or road users
- exit the vehicle and be caught by oncoming traffic
- operate vehicle equipment and become trapped

There is a risk of an accident and injury.

Always activate the child-proof locks and override feature if children are traveling in the vehicle. When leaving the vehicle, always take the key with you and lock the vehicle. Never leave children unattended in the vehicle.

Override feature for:

- the rear doors (▷ page 59)
- the rear side windows (▷ page 59)

WARNING

If you leave children unsupervised in the vehicle, they could set it in motion by, for example:

- release the parking brake.
- shift the automatic transmission out of the parking position **P**.
- start the engine.

In addition, they may operate vehicle equipment and become trapped. There is a risk of an accident and injury.

When leaving the vehicle, always take the SmartKey with you and lock the vehicle. Never leave children unsupervised in the vehicle.

WARNING

If persons, particularly children are subjected to prolonged exposure to extreme heat or cold, there is a risk of injury, possibly even fatal. Never leave children unattended in the vehicle.

⚠ WARNING

If the child restraint system is subjected to direct sunlight, parts may get very hot. Children may burn themselves on these parts, particularly on the metal parts of the child restraint system. There is a risk of injury.

If you leave the vehicle, taking the child with you, always ensure that the child restraint system is not exposed to direct sunlight. Protect it with a blanket, for example. If the child restraint system has been exposed to direct sunlight, let it cool down before securing the child in it. Never leave children unattended in the vehicle.

Child-proof locks for the rear doors

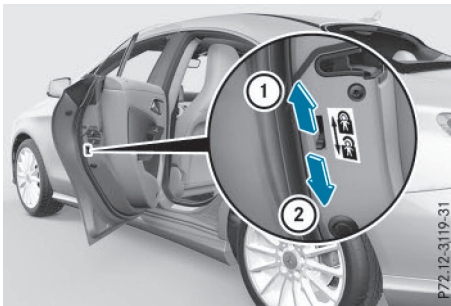

You secure each door individually with the child-proof locks on the rear doors. A door secured with a child-proof lock cannot be opened from inside the vehicle. When the vehicle is unlocked, the door can be opened from the outside.

- ▶ **To activate:** press the child-proof lock lever up in the direction of arrow ①.
- ▶ Make sure that the child-proof locks are working properly.
- ▶ **To deactivate:** press the child-proof lock lever down in the direction of arrow ②.

Override feature for the rear side windows

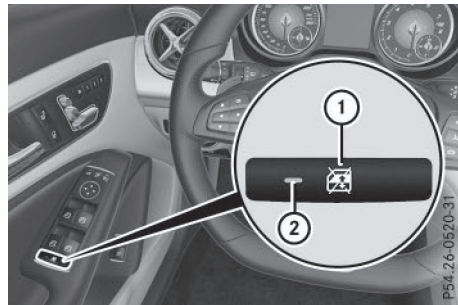

- ▶ **To activate/deactivate:** press button ①. If indicator lamp ② is lit, operation of the rear side windows is disabled. Operation is only possible using the switches in the driver's door. If indicator lamp ② is off, operation is possible using the switches in the rear compartment.

Pets in the vehicle

⚠ WARNING

If you leave animals unattended or unsecured in the vehicle, they could press buttons or switches, for example.

As a result, they could:

- activate vehicle equipment and become trapped, for example
- activate or deactivate systems, thereby endangering other road users

Unsecured animals could also be flung around the vehicle in the event of an accident or sudden steering or braking, thereby injuring vehicle occupants. There is a risk of an accident and injury.

Never leave animals unattended in the vehicle. Always secure animals properly during the journey, e.g. use a suitable animal transport box.

Driving safety systems

Overview of driving safety systems

In this section, you will find information about the following driving safety systems:

- **ABS (Anti-lock Braking System)** (> page 60)
- **BAS (Brake Assist System)** (> page 60)
- **Active Brake Assist** (> page 61)
- **ESP® (Electronic Stability Program)** (> page 63)
- **EBD (Electronic Brake force Distribution)** (> page 66)
- **ADAPTIVE BRAKE** (> page 66)
- **STEER CONTROL** (> page 66)

Important safety notes

If you fail to adapt your driving style or if you are inattentive, the driving safety systems can neither reduce the risk of an accident nor override the laws of physics. Driving safety systems are merely aids designed to assist driving. You are responsible for maintaining the distance to the vehicle in front, for vehicle speed, for braking in good time, and for staying in lane. Always adapt your driving style to suit the prevailing road and weather conditions and maintain a safe distance from the vehicle in front. Drive carefully.

The driving safety systems described only work as effectively as possible when there is adequate contact between the tires and the road surface. Please pay special attention to the notes on tires, recommended minimum tire tread depths, etc. (> page 282).

In wintry driving conditions, always use winter tires (M+S tires) and if necessary, snow chains. Only in this way will the driving safety systems described in this section work as effectively as possible.

ABS (Anti-lock Braking System)

General information

ABS regulates brake pressure in such a way that the wheels do not lock when you brake. This allows you to continue steering the vehicle when braking.

The  ABS warning lamp in the instrument cluster lights up when the ignition is switched on. It goes out when the engine is running.

ABS works from a speed of about 5 mph (8 km/h), regardless of road-surface conditions. ABS works on slippery surfaces, even when you only brake gently.

Important safety notes

i Observe the "Important safety notes" section (> page 60).

WARNING

If ABS is faulty, the wheels could lock when braking. The steerability and braking characteristics may be severely impaired. Additionally, further driving safety systems are deactivated. There is an increased danger of skidding and accidents.

Drive on carefully. Have ABS checked immediately at a qualified specialist workshop.

When ABS is malfunctioning, other systems, including driving safety systems, will also become inoperative. Observe the information on the ABS warning lamp (> page 218) and display messages which may be shown in the instrument cluster (> page 189).

Braking

- ▶ **If ABS intervenes:** continue to depress the brake pedal vigorously until the braking situation is over.
- ▶ **To make a full brake application:** depress the brake pedal with full force.

If ABS intervenes when braking, you will feel a pulsing in the brake pedal.

The pulsating brake pedal can be an indication of hazardous road conditions, and functions as a reminder to take extra care while driving.

BAS (Brake Assist System)

General information

BAS operates in emergency braking situations. If you depress the brake pedal quickly, BAS automatically boosts the braking force, thus shortening the stopping distance.

Important safety notes

- Observe the "Important safety notes" section (▷ page 60).

WARNING

If BAS is malfunctioning, the braking distance in an emergency braking situation is increased. There is a risk of an accident.

In an emergency braking situation, depress the brake pedal with full force. ABS prevents the wheels from locking.

Braking

- ▶ Keep the brake pedal firmly depressed until the emergency braking situation is over. ABS prevents the wheels from locking.

The brakes will function as usual once you release the brake pedal. BAS is deactivated.

Active Brake Assist

General information

- Observe the "Important safety notes" section (▷ page 60).

Active Brake Assist consists of a distance warning function with an autonomous braking function and braking assistance appropriate to the situation.

Active Brake Assist can help you to minimize the risk of a collision with the vehicle traveling in front or reduce the effects of such a collision.

If Active Brake Assist detects that there is a risk of collision, you will be warned visually and acoustically. If you do not react to the visual and audible collision warning, autonomous braking can be initiated in critical situations. If you apply the brake yourself in a critical situation, Adaptive Brake Assist supports you with braking assistance appropriate to the situation.

Important safety notes

Detection of hazardous situations can be particularly impaired by:

- there is dirt on the sensors or anything else covering the sensors
- there is snow or heavy rain
- there is interference by other radar sources

- there are strong radar reflections, for example in parking garages
- a narrow vehicle is traveling in front, e.g. a motorbike
- a vehicle is traveling in front on a different line
- new vehicles or after servicing is carried out on the Active Brake Assist system

Observe the important safety notes in the "Breaking-in notes" section (▷ page 120).

Following damage to the front end of the vehicle, have the configuration and operation of the radar sensor checked at a qualified specialist workshop. This also applies to collisions at low speeds where no visible damage to the front of the vehicle is apparent.

Activating/deactivating

Active Brake Assist is active after every ignition cycle.

You can activate or deactivate Active Brake Assist (▷ page 182) in the on-board computer. When deactivated, the distance warning function and the autonomous braking function are also deactivated.

If Active Brake Assist is deactivated, the  symbol appears in the assistance graphic display.

Distance warning function

General information

The distance warning function can help you to minimize the risk of a front-end collision with a vehicle ahead or reduce the effects of such a collision. If the distance warning function detects that there is a risk of a collision, you will be warned visually and acoustically.

Important safety notes

- Observe the "Important safety notes" section for driving safety systems (▷ page 60).

WARNING

The distance warning function does not react:

- to people or animals
- to oncoming vehicles
- to crossing traffic
- when cornering

Thus, the distance warning function cannot provide a warning in all critical situations. There is a risk of an accident.

Always pay careful attention to the traffic situation and be ready to brake.

WARNING

The distance warning function cannot always clearly identify objects and complex traffic situations.

In such cases, the distance warning function may:

- give an unnecessary warning
- not give a warning

There is a risk of an accident.

Always pay careful attention to the traffic situation and do not rely solely on the distance warning function.

Function

Starting at a speed of approximately 4 mph (7 km/h), the distance warning function warns you if you rapidly approach a vehicle in front. An intermittent warning tone will then sound, and the  distance warning lamp will light up in the instrument cluster.

- ▶ Brake immediately in order to increase the distance from the vehicle in front.

or

- ▶ Take evasive action, provided it is safe to do so.

Due to the nature of the system, particularly complicated but non-critical driving conditions may also cause the system to display a warning.

With the help of the radar sensor system, the distance warning function can detect obstacles that are in the path of your vehicle for an extended period of time.

Up to a speed of approximately 44 mph (70 km/h), the distance warning function can also react to stationary obstacles, such as stopped or parked vehicles.

Autonomous braking function

If the driver does not react to the distance warning signal in a critical situation, Active Brake Assist can assist the driver with the autonomous braking function.

The autonomous braking function:

- gives the driver more time to react to critical driving situations
- can help the driver to avoid an accident or
- reduces the effects of an accident

Vehicles without Distance Pilot DISTRONIC: the autonomous braking function is available in the following speed ranges:

- 4 - 65 mph (7 - 105 km/h) for moving objects
- 4 - 31 mph (7 - 50 km/h) for stationary objects

Vehicles with Distance Pilot DISTRONIC: the autonomous braking function is available in the following speed ranges:

- 4 - 124 mph (7 - 200 km/h) for moving objects
- 4 - 31 mph (7 - 50 km/h) for stationary objects

Due to the nature of the system, particularly complicated but non-critical driving conditions may also cause the Autonomous Braking Function to intervene.

Braking assistance appropriate to the situation

General information

-  Observe the "Important safety notes" section (> page 60).

With the help of the radar sensor system, Adaptive Brake Assist can detect obstacles that are in the path of your vehicle for an extended period of time.

If Adaptive Brake Assist detects a risk of collision with the vehicle in front, it calculates the brake pressure necessary to avoid a collision. If you apply the brakes forcefully, the braking assistance adapts to the situation and automatically increases the brake pressure to a degree appropriate to the traffic situation.

Braking assistance appropriate to the situation provides braking assistance in hazardous situations at speeds above 4 mph (7 km/h). It uses radar sensor technology to assess the traffic situation.

Situation-dependent braking assistance is capable of reacting to moving objects that have already been recognized as such at least once over the period of observation, up to vehicle speeds of around 155 mph (250 km/h).

Braking assistance appropriate to the situation can also detect stationary objects, up to vehicle speeds of around 44 mph 70 km/h.

- ▶ Keep the brake pedal depressed until the emergency braking situation is over. ABS prevents the wheels from locking.

The brakes will work normally again if:

- you release the brake pedal.
- there is no longer any danger of a collision.
- no obstacle is detected in front of your vehicle.

Braking assistance appropriate to the situation is then deactivated.

Important safety notes

- i** Observe the "Important safety notes" section for driving safety systems (▷ page 60).

WARNING

Adaptive Brake Assist does not react:

- to people or animals
- to oncoming vehicles
- to crossing traffic
- when cornering

As a result, Adaptive Brake Assist may not intervene in all critical conditions. There is a risk of an accident.

Always pay careful attention to the traffic situation and be ready to brake.

WARNING

Adaptive Brake Assist cannot always clearly identify objects and complex traffic situations.

In such cases, Adaptive Brake Assist might:

- intervene unnecessarily
- not intervene

There is a risk of an accident.

Always pay careful attention to the traffic situation and be ready to brake. Terminate the intervention in a non-critical driving situation.

Due to the nature of the system, complex but non-critical driving conditions may also cause Active Brake Assist to intervene.

Even if Active Brake Assist is not available due to a malfunction in the radar sensor system, the

brake system is still available with full brake boosting effect and BAS.

ESP® (Electronic Stability Program)

General notes

- i** Observe the "Important safety notes" section (▷ page 60).

ESP® monitors driving stability and traction, i.e. power transmission between the tires and the road surface.

If ESP® detects that the vehicle is deviating from the direction desired by the driver, one or more wheels are braked to stabilize the vehicle. The engine output is also modified to keep the vehicle on the desired course within physical limits. ESP® assists the driver when pulling away on wet or slippery roads. ESP® can also stabilize the vehicle during braking.

ETS/4ETS (Electronic Traction System)

- i** Observe the "Important safety notes" section (▷ page 60).

ETS traction control is part of ESP®. On vehicles with 4MATIC, 4ETS is part of ESP®.

Traction control brakes the drive wheels individually if they spin. This enables you to pull away and accelerate on slippery surfaces, for example if the road surface is slippery on one side. In addition, more drive torque is transferred to the wheel or wheels with traction.

Traction control remains active, even if you deactivate ESP®.

Important safety notes

- i** Observe the "Important safety notes" section (▷ page 60).



WARNING

If ESP® is malfunctioning, ESP® is unable to stabilize the vehicle. Additionally, further driving safety systems are deactivated. This increases the risk of skidding and an accident.

Drive on carefully. Have ESP® checked at a qualified specialist workshop.

Vehicles without 4MATIC: when towing your vehicle with the front axle raised, it is important that you observe the notes on ESP® (▷ page 277).

If the  ESP® OFF warning lamp lights up continuously, ESP® is deactivated.

If the  ESP® warning lamp and the  warning lamp are lit continuously, ESP® is not available due to a malfunction.

Observe the information on warning lamps (▷ page 219) and display messages which may be shown in the instrument cluster (▷ page 189).

Only use wheels with the recommended tire sizes. Only then will ESP® function properly.

Characteristics of ESP®

General information

If the  ESP® warning lamp goes out before beginning the journey, ESP® is automatically active.

If ESP® intervenes, the  ESP® warning lamp flashes in the instrument cluster.

If ESP® intervenes:

- ▶ Do not deactivate ESP® under any circumstances.
- ▶ Only depress the accelerator pedal as far as necessary when pulling away.
- ▶ Adapt your driving style to suit the prevailing road and weather conditions.

ECO start/stop function

The ECO start/stop function switches the engine off automatically when the vehicle stops moving. The engine starts automatically when the driver wants to pull away again. ESP® remains in its previously selected status. **Example:** if ESP® was deactivated before the engine was switched off, ESP® remains deactivated when the engine is switched on again.

Deactivating/activating ESP® (except Mercedes-AMG vehicles)

Important safety notes

- ❗ Observe the "Important safety notes" section (▷ page 60).

You can select between the following states of ESP®:

- ESP® is activated.
- ESP® is deactivated.

WARNING

If you deactivate ESP®, ESP® no longer stabilizes the vehicle. There is an increased risk of skidding and an accident.

Only deactivate ESP® in the situations described in the following.

The spinning of the wheels results in a cutting action for better traction on loose surfaces. It may be best to deactivate ESP® in the following situations:

- when using snow chains
- in deep snow
- on sand or gravel

❗ Activate ESP® as soon as the situations described above no longer apply. ESP® will otherwise not be able to stabilize the vehicle if the vehicle starts to skid or a wheel starts to spin.

❗ Avoid spinning the driven wheels for an extended period with ESP® deactivated. You could otherwise damage the drivetrain.

Deactivating/activating ESP®

You can deactivate or activate ESP® via the on-board computer (▷ page 182).

ESP® deactivated:

The  ESP® OFF warning lamp in the instrument cluster lights up.

ESP® activated:

The  ESP® OFF warning lamp in the instrument cluster goes out.

Characteristics when ESP® is deactivated

If ESP® is deactivated and one or more wheels start to spin, the  ESP® warning lamp in the instrument cluster flashes. In such situations, ESP® will not stabilize the vehicle.

If you deactivate ESP®:

- ESP® no longer improves driving stability.
- Engine torque is no longer limited and the drive wheels are able to spin.

- Traction control is still activated.
- STEER CONTROL is no longer active
- ESP® still provides support when you brake firmly.

Deactivating/activating ESP® (Mercedes-AMG vehicles)

Important safety notes

- i** Observe the "Important safety notes" section (> page 60).

You can select between the following states of ESP®:

- ESP® is activated.
- SPORT handling mode is activated.
- ESP® is deactivated.

⚠ WARNING

When SPORT handling mode is activated, there is a greater risk of skidding and accidents.

Only activate SPORT handling mode in the situations described in the following.

⚠ WARNING

If you deactivate ESP®, ESP® no longer stabilizes the vehicle. There is an increased risk of skidding and an accident.

Only deactivate ESP® in the situations described in the following.

In the following situations, it may be better to activate SPORT handling mode or deactivate ESP®:

- when using snow chains
- in deep snow
- on sand or gravel
- on specially designated roads when the vehicle's own oversteering and understeering characteristics are desired

Driving in SPORT handling mode or without ESP® requires an extremely qualified and experienced driver.

- i** Activate ESP® as soon as the situations described above no longer apply. ESP® will otherwise not be able to stabilize the vehicle if

the vehicle starts to skid or a wheel starts to spin.

- !** Avoid spinning the driven wheels for an extended period with ESP® deactivated. You could otherwise damage the drivetrain.

Deactivating/activating ESP®

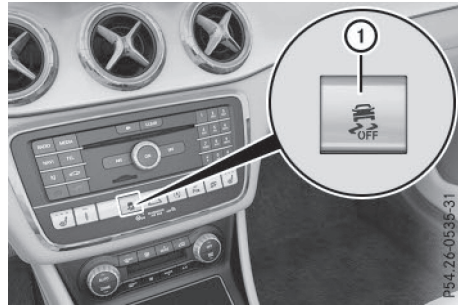

- ▶ **To activate SPORT handling mode:** briefly press button ①. The **SPORT** SPORT handling mode warning lamp in the instrument cluster lights up. The **SPORT handling mode** message appears in the multifunction display.
- ▶ **To deactivate SPORT handling mode:** briefly press button ①. The **SPORT** SPORT handling mode warning lamp in the instrument cluster goes out.
- ▶ **To deactivate ESP®:** press button ① until the **ESP OFF** ESP® OFF warning lamp lights up in the instrument cluster. The **ESP OFF** message appears in the multifunction display.
- ▶ **To activate ESP®:** briefly press button ①. The **ESP OFF** ESP® OFF warning lamp in the instrument cluster goes out. The **ESP ON** message appears in the multifunction display.

Characteristics of activated SPORT handling mode

If SPORT handling mode is activated and one or more wheels start to spin, the **ESP** ESP® warning lamp in the instrument cluster flashes. ESP® only stabilizes the vehicle to a limited degree.

When SPORT handling mode is activated:

- ESP® only improves driving stability to a limited degree.
- Traction control is still activated.

- The engine's torque is only restricted to a limited degree and the drive wheels may start to spin.
The spinning of the wheels results in a cutting action for better traction on loose surfaces.
- ESP® still provides support when you brake firmly.

Characteristics when ESP® is deactivated

If ESP® is deactivated and one or more wheels start to spin, the  ESP® warning lamp in the instrument cluster does not flash. In such situations, ESP® will not stabilize the vehicle.

If you deactivate ESP®:

- ESP® no longer improves driving stability.
- Engine torque is no longer limited and the drive wheels are able to spin.
The spinning of the wheels results in a cutting action for better traction on loose surfaces.
- Traction control is still activated.
- Active Brake Assist is no longer available; nor is it activated if you brake firmly with assistance from ESP®
- ESP® still provides support when you brake firmly.

ESP® trailer stabilization

General information

If your vehicle/trailer combination begins to swerve, ESP® assists you in this situation. ESP® slows the vehicle down by braking and limiting the engine output until the vehicle/trailer combination has stabilized.

Important safety notes

WARNING

If road and weather conditions are poor, trailer stabilization will not be able to prevent the vehicle/trailer combination from swerving. Trailers with a high center of gravity can tip over before ESP® can detect this. There is a risk of an accident.

Always adapt your driving style to the prevailing road and weather conditions.

If your vehicle with trailer (vehicle/trailer combination) begins to lurch, you can only stabilize

the vehicle/trailer combination by depressing the brake firmly.

ESP® trailer stabilization is active above speeds of about 65 km/h.

ESP® trailer stabilization does not work if ESP® is deactivated or disabled because of a malfunction.

EBD (electronic brake force distribution)

General information

EBD monitors and controls the brake pressure on the rear wheels to improve driving stability while braking.

Important safety notes

- ① Observe the "Important safety notes" section (> page 60).

WARNING

If EBD is malfunctioning, the rear wheels can lock, e.g. under full braking. This increases the risk of skidding and an accident.

You should therefore adapt your driving style to the different handling characteristics. Have the brake system checked at a qualified specialist workshop.

Observe information regarding indicator and warning lamps (> page 218) as well as display messages (> page 191).

ADAPTIVE BRAKE

ADAPTIVE BRAKE enhances braking safety and offers increased braking comfort. In addition to the braking function, ADAPTIVE BRAKE also has the HOLD function (> page 156) and hill start assist (> page 124).

STEER CONTROL

General information

STEER CONTROL helps you by transmitting a noticeable steering force to the steering wheel in the direction required for vehicle stabilization.

This steering assistance is provided in particular if:

- both right wheels or both left wheels are on a wet or slippery road surface when you brake
- the vehicle begins to skid

Important safety notes

- i** Observe the "Important safety notes" section (▷ page 60).

No steering assistance is provided from STEER CONTROL, if:

- ESP® is malfunctioning
- the steering is malfunctioning

If ESP® is malfunctioning, you will be assisted further by the electrical power steering.

Protection against theft

Immobilizer

The immobilizer prevents your vehicle from being started without the correct SmartKey.

- ▶ **To activate with the SmartKey:** remove the SmartKey from the ignition lock.
- ▶ **To activate with KEYLESS-GO start-function or KEYLESS-GO:** switch the ignition off and open the driver's door.
- ▶ **To deactivate:** switch on the ignition.

When leaving the vehicle, always take the SmartKey with you and lock the vehicle. Anyone can start the engine if a valid SmartKey has been left inside the vehicle.

- i** The immobilizer is always deactivated when you start the engine.
- In the event that the engine cannot be started (yet the vehicle's battery is charged), the system is not operational. Contact an authorized Mercedes-Benz Center or call 1-800-FOR-MERCEdes (in the USA) or 1-800-387-0100 (in Canada).

ATA (anti-theft alarm system)



- ▶ **To arm:** lock the vehicle with the SmartKey or KEYLESS-GO.

Indicator lamp ① flashes. The alarm system is armed after approximately 15 seconds.

- ▶ **To disarm:** unlock the vehicle with the SmartKey or KEYLESS-GO.

or

- ▶ Insert the SmartKey into the ignition lock.

A visual and audible alarm is triggered if the alarm system is armed and you open:

- a door
- the vehicle with the mechanical key
- the trunk lid
- the hood

- ▶ **To turn the alarm off with the SmartKey:** press the  or  button on the SmartKey.

The alarm is stopped.

or

- ▶ **Vehicles with KEYLESS-GO start-function or KEYLESS-GO:** remove the Start/Stop button from the ignition lock (▷ page 121).

- ▶ Insert the SmartKey into the ignition lock. The alarm is stopped.

- ▶ **To stop the alarm using KEYLESS-GO:** grasp the outside door handle. The SmartKey must be outside the vehicle. The alarm is stopped.

or

- ▶ Press the Start/Stop button on the dashboard. The SmartKey must be inside the vehicle. The alarm is stopped.

The alarm is not switched off, even if you close the open door that triggered it, for example.

i If the alarm continues for more than 30 seconds, the mbrace emergency call system automatically notifies the Customer Assistance Center. This is done either by text message or data connection.

The emergency call system sends the message or data provided that:

- you have subscribed to the mbrace service.
- the mbrace service has been activated properly.
- the necessary mobile phone network is available.

SmartKey

Important safety notes

WARNING

If children are left unsupervised in the vehicle, they could:

- open the doors, thus endangering other people or road users.
- get out and disrupt traffic.
- operate the vehicle's equipment.

Additionally, children could set the vehicle in motion if, for example, they:

- release the parking brake.
- shifting the automatic transmission out of park position **P**
- Start the engine.

There is a risk of an accident and injury.

When leaving the vehicle, always take the SmartKey with you and lock the vehicle. Never leave children or animals unattended in the vehicle. Always keep the SmartKey out of reach of children.

WARNING

If you attach heavy or large objects to the SmartKey, the SmartKey could be unintentionally turned in the ignition lock. This could cause the engine to be switched off. There is a risk of an accident.

Do not attach any heavy or large objects to the SmartKey. Remove any bulky key rings before inserting the SmartKey into the ignition lock.

- !** Keep the SmartKey away from strong magnetic fields. Otherwise, the remote control function could be affected.

Strong magnetic fields can occur in the vicinity of powerful electrical installations.

Do not keep the SmartKey:



- with electronic devices, e.g. a mobile phone or another SmartKey.
- with metallic objects, e.g. coins or metal foil.
- inside metallic objects, e.g. a metal case

Vehicles with KEYLESS-GO start function: do not keep the SmartKey in the trunk. Otherwise,

the SmartKey may not be detected, e.g. when starting the engine using the Start/Stop button.

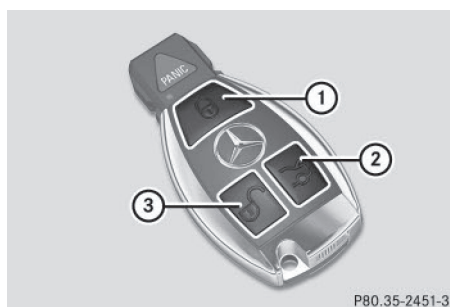
SmartKey functions



- ①  To lock the vehicle
- ②  To open the trunk lid
- ③  To unlock the vehicle

If you do not open the vehicle within approximately 40 seconds of unlocking:

- the vehicle is locked again.
- anti-theft protection is reactivated.

► **To lock:** press the  button.

The SmartKey centrally locks/unlocks:

- the doors
- the trunk lid
- the fuel filler flap

The turn signals flash once when unlocking and three times when locking.

When the locator lighting is activated via the multimedia system, it lights up when it is dark after the vehicle is unlocked with the remote control (see the separate operating instructions).

You can also set an audible signal to confirm that the vehicle has been locked. The audible signal can be activated and deactivated using the on-board computer (▷ page 185).

► **To open the trunk lid automatically:** press and hold the  button until the trunk lid opens (▷ page 78).

KEYLESS-GO

General notes

Bear in mind that the engine can be started by any of the vehicle occupants if there is a SmartKey in the vehicle.

Locking and unlocking

You can start, lock or unlock the vehicle using KEYLESS-GO. To do this, you only need carry the SmartKey with you. You can combine the functions of KEYLESS-GO with those of a conventional SmartKey. Unlock the vehicle by using KEYLESS-GO, for instance, and lock it using the  button on the SmartKey.

The driver's door and the door at which the handle is used, must both be closed. The SmartKey must be outside the vehicle. When locking or unlocking with KEYLESS-GO, the distance between the SmartKey and the corresponding door handle must not be greater than 3 ft (1 m).

A check which periodically establishes a radio connection between the vehicle and the SmartKey determines whether a valid SmartKey is in the vehicle. This occurs, for example:

- when starting the engine
- while driving
- when using HANDS-FREE ACCESS
- when the external door handles are touched
- during convenience closing

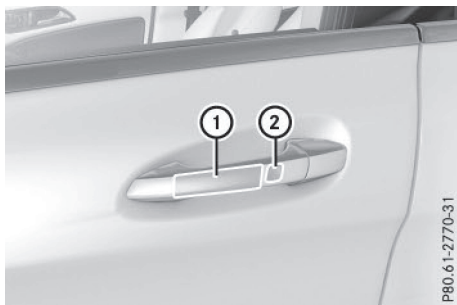

- ▶ **To unlock the vehicle:** touch the inner surface of the door handle.
- ▶ **To lock the vehicle:** touch sensor surface ① or ②.

Make sure that you do not touch the inner surface of the door handle.

- ▶ **Convenience closing feature:** touch recessed sensor surface ② for an extended period.

Further information on the convenience closing feature (▷ page 82).



- ▶ **To unlock the trunk lid:** pull trunk lid handle ①.

Deactivating and activating

If you do not intend to use the vehicle for a longer period of time, you can deactivate KEYLESS-GO. The SmartKey will then use very little power, thereby conserving battery power. For the purposes of activation/deactivation, the vehicle must not be nearby.

- ▶ **To deactivate:** press the  button on the SmartKey twice in rapid succession.

The battery check lamp of the SmartKey flashes twice briefly and lights up once, then KEYLESS-GO is deactivated (▷ page 72).

- ▶ **To activate:** press any button on the SmartKey.

or

- ▶ Insert the SmartKey into the ignition lock. KEYLESS-GO and all of its associated features are available again.



KEYLESS-GO start function



General notes

Bear in mind that the engine can be started by any of the vehicle occupants if there is a SmartKey in the vehicle.

Changing the settings of the locking system

You can change the settings of the locking system. This means that only the driver's door and the fuel filler flap are unlocked when the vehicle is unlocked. This is useful if you frequently travel on your own.

- ▶ **To change the setting:** press and hold the  and  buttons simultaneously for approximately six seconds until the battery indicator lamp flashes twice (▷ page 72).



If the setting of the locking system is changed within the signal range of the vehicle, pressing the  or  button:

- locks or
- unlocks the vehicle

The SmartKey now functions as follows:

- ▶ **To unlock:** press the  button once.
- ▶ **To unlock centrally:** press the  button twice.
- ▶ **To lock centrally:** press the  button.

The KEYLESS-GO function is changed as follows:

- ▶ **To unlock the driver's door:** touch the inner surface of the door handle on the driver's door.
- ▶ **To unlock centrally:** touch the inner surface of the door handle on the front-passenger door or the rear door.
- ▶ **To lock centrally:** touch the outer sensor surface on one of the door handles.
- ▶ **To restore the factory settings:** press and hold the  and  buttons simultaneously for approximately six seconds until the battery check lamp flashes twice (▷ page 72).



Mechanical key

General notes

If the vehicle can no longer be locked or unlocked with the SmartKey or KEYLESS-GO, use the mechanical key.

If you use the mechanical key to unlock and open the driver's door or the trunk lid, the anti-theft alarm system will be triggered (▷ page 67).

There are several ways to turn off the alarm:

- ▶ **To deactivate the alarm with the key:** press the  or  button on the key.
or
- ▶ Insert the SmartKey into the ignition lock.
or
- ▶ **To deactivate the alarm with KEYLESS-GO:** press the Start/Stop button in the ignition lock. The SmartKey must be in the vehicle.
or
- ▶ Lock or unlock the vehicle using KEYLESS-GO. The SmartKey must be outside the vehicle.

If you unlock the vehicle using the mechanical key, the fuel filler flap will not be unlocked automatically.

- ▶ **To unlock the fuel filler flap:** insert the SmartKey into the ignition lock.

Removing the mechanical key

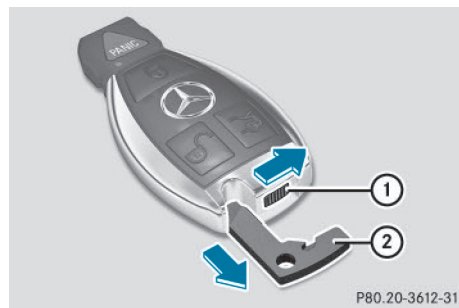

- ▶ Push release catch ① in the direction of the arrow and at the same time remove mechanical key ② from the SmartKey.

For further information about:

- Unlocking the driver's door (▷ page 76)
- Unlocking the trunk (▷ page 80)
- Locking the vehicle (▷ page 76)

Inserting the mechanical key

- ▶ Push mechanical key ② completely into the SmartKey until it engages and release catch ① is back in its basic position.

SmartKey battery

Important safety notes

WARNING

Batteries contain toxic and corrosive substances. If batteries are swallowed, it can result in severe health problems. There is a risk of fatal injury.





Keep batteries out of the reach of children. If a battery is swallowed, seek medical attention immediately.

The SmartKey batteries contain perchlorate material, which may require special handling and regard for the environment. National guidelines must be observed during disposal. In California, see www.dtsc.ca.gov/HazardousWaste/Perchlorate/index.cfm.

Mercedes-Benz recommends that you have the battery replaced at a qualified specialist workshop.

Checking the battery



- ▶ Press the  or  button. The battery is working properly if battery check lamp ① lights up briefly. The battery is discharged if battery check lamp ① does not light up briefly.
- ▶ Change the battery (> page 72).
- i** If the SmartKey battery is checked within the signal reception range of the vehicle, pressing the  or  button:
 - locks or
 - unlocks the vehicle
- i** You can get a battery at any qualified specialist workshop.

Replacing the battery

You require a CR 2025 3 V cell battery.

- ▶ Take the mechanical key out of the SmartKey (> page 71).

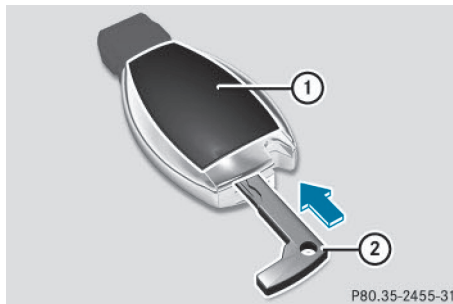



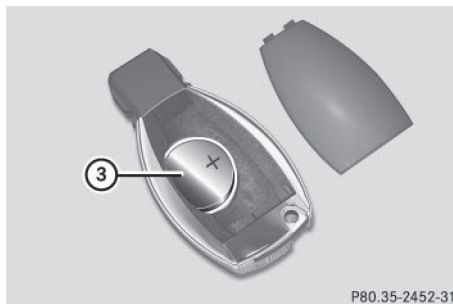

- ▶ Press mechanical key ② into the opening in the SmartKey in the direction of the arrow until battery tray cover ① opens. When doing so, do not hold cover ① shut.
- ▶ Remove battery tray cover ①.



- ▶ Repeatedly tap the SmartKey against your palm until battery ③ falls out.
- ▶ Insert the new battery with the positive terminal facing upwards. Use a lint-free cloth to do so.
- ▶ Make sure that the surface of the battery is free of lint, grease and other contaminants.
- ▶ Insert the front tabs of battery tray cover ① and then press to close it.
- ▶ Insert mechanical key into the SmartKey (> page 71).
- ▶ Check the function of all SmartKey buttons on the vehicle.

Problems with the SmartKey

Problem	Possible causes/consequences and ► Solutions
<p>You cannot lock or unlock the vehicle using the SmartKey.</p>	<p>The SmartKey battery is discharged or nearly discharged.</p> <p>► Vehicles without KEYLESS-GO or KEYLESS-GO start function: try again to lock/unlock the vehicle using the remote control function of the SmartKey. Point the tip of the SmartKey at the driver's door handle from close range and press the  or  button.</p> <p>If this does not work:</p> <p>► Check the SmartKey battery (▷ page 72) and replace it if necessary (▷ page 72).</p> <p>► Unlock (▷ page 76) or lock (▷ page 76) the vehicle using the mechanical key.</p> <p>There is interference from a powerful source of radio waves.</p> <p>► Vehicles without KEYLESS-GO or KEYLESS-GO start function: try again to lock/unlock the vehicle using the remote control function of the SmartKey. Point the tip of the SmartKey at the driver's door handle from close range and press the  or  button.</p> <p>If this does not work:</p> <p>► Unlock (▷ page 76) or lock (▷ page 76) the vehicle using the mechanical key.</p> <p>The SmartKey is faulty.</p> <p>► Unlock (▷ page 76) or lock (▷ page 76) the vehicle using the mechanical key.</p> <p>► Have the SmartKey checked at a qualified specialist workshop.</p>
<p>You can no longer lock or unlock the vehicle using KEYLESS-GO.</p>	<p>The SmartKey battery is discharged or nearly discharged.</p> <p>► Check the SmartKey battery (▷ page 72) and replace it if necessary (▷ page 72).</p> <p>If this does not work:</p> <p>► Unlock (▷ page 76) or lock (▷ page 76) the vehicle using the mechanical key.</p> <p>There is interference from a powerful source of radio waves.</p> <p>► Unlock (▷ page 76) or lock (▷ page 76) the vehicle using the mechanical key.</p>

Problem	Possible causes/consequences and ► Solutions
	<p>KEYLESS-GO is malfunctioning.</p> <ul style="list-style-type: none"> ► Lock/unlock the vehicle using the remote control function of the SmartKey. ► Have the vehicle and SmartKey checked at a qualified specialist workshop. <p>If the vehicle can also not be locked/unlocked using the remote control function:</p> <ul style="list-style-type: none"> ► Unlock (▷ page 76) or lock (▷ page 76) the vehicle using the mechanical key. ► Have the vehicle and SmartKey checked at a qualified specialist workshop.
The engine cannot be started using the SmartKey.	<p>The on-board voltage is too low.</p> <ul style="list-style-type: none"> ► Switch off non-essential consumers, e.g. seat heating or interior lighting, and try to start the engine again. <p>If this does not work:</p> <ul style="list-style-type: none"> ► Check the starter battery and charge it if necessary (▷ page 273). or ► Jump-start the vehicle (▷ page 273). or ► Consult a qualified specialist workshop.
The engine cannot be started using the Start/Stop button. The SmartKey is in the vehicle.	<p>The vehicle is locked.</p> <ul style="list-style-type: none"> ► Unlock the vehicle and try to start the vehicle again. <p>The SmartKey battery is discharged or nearly discharged.</p> <ul style="list-style-type: none"> ► Check the SmartKey battery (▷ page 72) and replace it if necessary (▷ page 72). <p>If this does not work:</p> <ul style="list-style-type: none"> ► Start your vehicle with the SmartKey in the ignition lock. <p>There is interference from a powerful source of radio waves.</p> <ul style="list-style-type: none"> ► Start your vehicle with the SmartKey in the ignition lock.
You have lost a SmartKey.	<ul style="list-style-type: none"> ► Have the SmartKey deactivated at a qualified specialist workshop. ► Report the loss immediately to the vehicle insurers. ► If necessary, have the locks changed as well.
You have lost the mechanical key.	<ul style="list-style-type: none"> ► Report the loss immediately to the vehicle insurers. ► If necessary, have the locks changed as well.

Doors

Important safety notes

 **WARNING**

If children are left unsupervised in the vehicle, they could:

- open the doors, thus endangering other people or road users.
- get out and disrupt traffic.
- operate the vehicle's equipment.

Additionally, children could set the vehicle in motion if, for example, they:

- release the parking brake.
- shifting the automatic transmission out of park position **P**
- Start the engine.

There is a risk of an accident and injury.

When leaving the vehicle, always take the SmartKey with you and lock the vehicle. Never leave children or animals unattended in the vehicle. Always keep the SmartKey out of reach of children.

You should preferably place luggage or loads in the cargo compartment. Observe the loading guidelines (▷ page 233).

Unlocking and opening doors from the inside

! The side windows will not open/close if the battery is discharged or if the side windows have iced up. It will then not be possible to close the door. Do not attempt to force the door closed. You could otherwise damage the door or the side window.

When a door is opened, the side window on that side opens slightly. When the door is closed, the side window closes again.

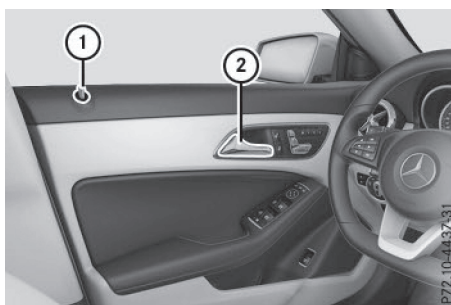

► **To unlock and open a front door:** pull door handle ②.

If the door is locked, locking knob ① pops up. The door is unlocked and opens.

► **To unlock a rear door:** pull up locking knob ①.

The door is unlocked and can be opened.

► **To open a rear door:** pull door handle ②.

You can open a door from inside the vehicle even if it has been locked. You can only open the rear doors from inside the vehicle if they are not secured by the child-proof locks (▷ page 59).

If the vehicle has previously been locked with the SmartKey from the outside, opening a door from the inside will trigger the anti-theft alarm system. Switch off the alarm (▷ page 67).

Centrally locking and unlocking the vehicle from the inside

You can centrally lock or unlock the vehicle from the inside. This can be useful if you wish to lock the vehicle before pulling away, for example.



► **To unlock:** press button ①.

► **To lock:** press button ②.

If all the doors and the trunk lid are closed, the vehicle locks.

Meanwhile, the fuel filler flap will not be locked or unlocked.

You cannot unlock the vehicle centrally from the inside if the vehicle has been locked with the SmartKey or KEYLESS-GO.

You can open a door from inside the vehicle even if it has been locked. You can open the rear doors from inside the vehicle unless they are secured by the child-proof lock (▷ page 59).

If the vehicle has previously been locked with the SmartKey from the outside, opening a door from the inside will trigger the anti-theft alarm system. Switch off the alarm (▷ page 67).

If a locked door is opened from the inside, the previous unlock status of the vehicle will be taken into consideration if:

- the vehicle was locked using the locking button for the central locking, or
- if the vehicle was locked automatically

The vehicle will be fully unlocked if it had previously been fully unlocked. If only the driver's door had been previously unlocked, only the door which has been opened from the inside is unlocked.

Automatic locking feature

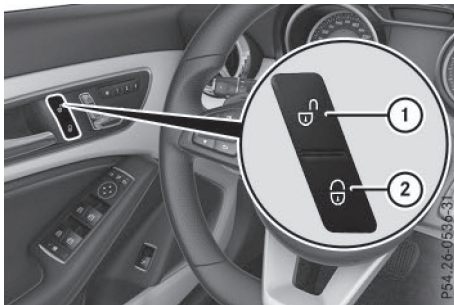

- ▶ **To deactivate:** press and hold button ① for approximately five seconds until a tone sounds.
- ▶ **To activate:** press and hold button ② for approximately five seconds until a tone sounds.

If you press one of the two buttons and do not hear a tone, the relevant setting has already been selected.

The vehicle is locked automatically when the ignition is switched on and the wheels are turning.

You could therefore lock yourself out if:

- the vehicle is being pushed.
- the vehicle is being towed.
- the vehicle is on a roller dynamometer.

You can also switch the automatic locking function on and off using the on-board computer (▷ page 184).

Unlocking the driver's door (mechanical key)

If the vehicle can no longer be locked or unlocked with the SmartKey or KEYLESS-GO, use the mechanical key.

If you use the mechanical key to unlock and open the driver's door, the anti-theft alarm system will be triggered (▷ page 67).

- ▶ Take the mechanical key out of the SmartKey (▷ page 71).
- ▶ Insert the mechanical key into the lock of the driver's door as far as it will go.

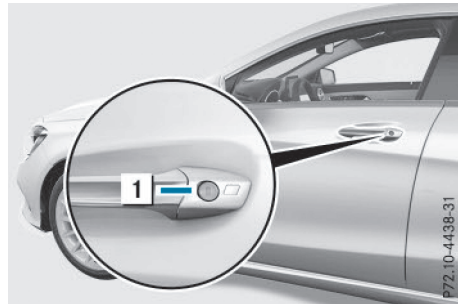

- ▶ Turn the mechanical key counter-clockwise as far as it will go to position 1. The door is unlocked.
- ▶ Turn the mechanical key back and remove it.
- ▶ Insert mechanical key into the SmartKey (▷ page 71).

Locking the vehicle (mechanical key)

If the vehicle can no longer be locked with the SmartKey or KEYLESS-GO, use the mechanical key.

- ▶ Open the driver's door.
- ▶ Close the front-passenger door, the rear doors and the trunk lid.

- ▶ Press the locking button on the driver's door (> page 75).
- ▶ Check whether the locking knobs on the front-passenger door and the rear doors are still visible. Press down the locking knobs by hand, if necessary.
- ▶ Close the driver's door.
- ▶ Take the mechanical key out of the SmartKey (> page 71).
- ▶ Insert the mechanical key into the lock of the driver's door as far as it will go.

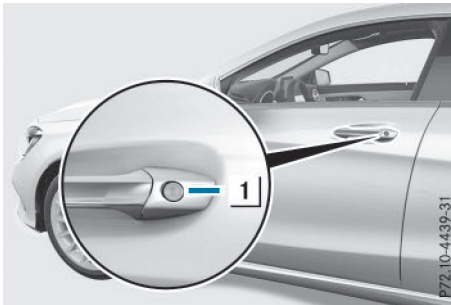

- ▶ Turn the mechanical key clockwise as far as it will go to position **1**.
- ▶ Turn the mechanical key back and remove it.
- ▶ Make sure that the doors and the trunk lid are locked.
- ▶ Insert mechanical key into the SmartKey (> page 71).

i If you lock the vehicle as described above, the fuel filler flap is not locked. The anti-theft alarm system is not armed.

Trunk

Important safety notes

⚠ WARNING

Combustion engines emit poisonous exhaust gases such as carbon monoxide. Exhaust gases can enter the vehicle interior if the trunk lid is open when the engine is running, especially if the vehicle is in motion. There is a risk of poisoning.

Always switch off the engine before opening the trunk lid. Never drive with the trunk lid open.

⚠ WARNING

If objects, luggage or loads are not secured or not secured sufficiently, they could slip, tip over or be flung around and thereby hit vehicle occupants. There is a risk of injury, particularly in the event of sudden braking or a sudden change in direction.

Always store objects so that they cannot be flung around. Secure objects, luggage or loads against slipping or tipping before the journey.

! The trunk lid swings upwards when opened. Therefore, make sure that there is sufficient clearance above the trunk lid.

The opening dimensions of the trunk lid can be found in the "Vehicle data" section (> page 314).

You should preferably place luggage or loads in the trunk. Observe the loading guidelines (> page 233).

Do not leave the SmartKey in the trunk. You could otherwise lock yourself out.

The trunk lid can be:

- opened and closed manually from outside
- opened automatically from outside
- opened automatically from inside
- released with the emergency release from the inside

Opening/closing from outside

Opening



- ▶ Press the  button on the SmartKey.
- ▶ Pull handle **1**.
- ▶ Raise the trunk lid.

Closing

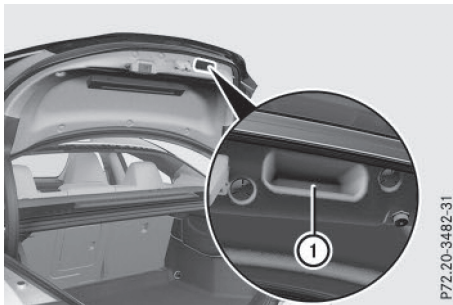

- ▶ Pull down the trunk lid using handle ①.
- ▶ Let the trunk lid drop into the lock.
- ▶ If necessary, lock the vehicle with the  button on the SmartKey or with KEYLESS-GO.

Opening automatically from outside

Important safety notes

WARNING

Combustion engines emit poisonous exhaust gases such as carbon monoxide. Exhaust gases can enter the vehicle interior if the trunk lid is open when the engine is running, especially if the vehicle is in motion. There is a risk of poisoning.

Always switch off the engine before opening the trunk lid. Never drive with the trunk lid open.

- ❗ The trunk lid swings upwards when opened. Therefore, make sure that there is sufficient clearance above the trunk lid.
- i The opening dimensions of the trunk lid can be found under "Vehicle data" (▶ page 314).

Opening automatically

You can open the trunk lid automatically using the SmartKey or the handle in the trunk lid.

- ▶ Press and hold the  button on the SmartKey until the trunk lid opens.
- or
- ▶ If the trunk lid is unlocked, pull the trunk lid handle and let it go again immediately.

HANDS-FREE ACCESS

Important safety notes

WARNING

The vehicle's exhaust system may be very hot. You could burn yourself by touching the exhaust system if you use HANDS-FREE ACCESS. There is a risk of injury. Always ensure that you only make the kicking movement within the detection range of sensors.

- ❗ If the SmartKey is within the rear detection range of KEYLESS-GO, the following situations, for example, could lead to the unintentional opening of the trunk:
 - using a car wash
 - using a power washer

Make sure that the SmartKey is at least 10 ft (3 m) away from the vehicle.

- i You can also deactivate KEYLESS-GO. Further information on deactivating and activating KEYLESS-GO (▶ page 70).

General notes

With KEYLESS-GO and HANDS-FREE ACCESS, you can open the trunk lid without using your hands. This is useful if you have your hands full. To do this, make a kicking movement under the bumper with your foot.

Observe the following points:

- Carry your KEYLESS-GO key about your person. The KEYLESS-GO key must be in the rear detection range of the vehicle.
- When making the kicking movement, make sure that you are standing firmly on the ground and that there is sufficient clearance to the rear of the vehicle. You could otherwise lose your balance, for example on ice.

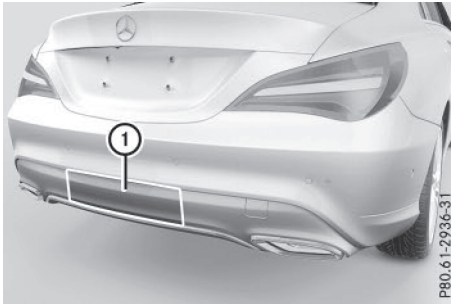

- Always ensure that you only make the kicking movement within the detection range of sensors ①.
- Stand at least 12 in (30 cm) away from the rear area while doing so.
- Do not come into contact with the bumper while making the kicking movement. Otherwise, the sensors may not function correctly.
- HANDS-FREE ACCESS does not function when the engine is started.
- Dirt caused by road salt around sensors ① may restrict functionality.
Using the HANDS-FREE ACCESS with a prosthetic leg may restrict functionality.
- If a KEYLESS-GO key is within the rear detection range of KEYLESS-GO, HANDS-FREE ACCESS could be triggered. The trunk lid could thus be opened unintentionally, for example, when you:
 - set something down or lift something up behind the vehicle.
 - polish the rear of the vehicle.
 Do not carry the KEYLESS-GO key about your person in these situations or in situations similar to these. This will prevent the unintentional opening of the trunk lid.

Operation

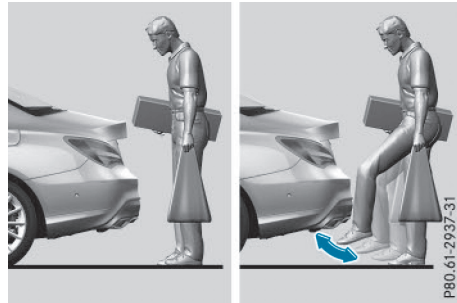

- ▶ **To open:** kick into sensor detection range ① below the bumper with your foot.
- ▶ **If the trunk lid does not open after several attempts:** wait at least ten seconds then move your leg under the bumper once again.

If you hold your foot under the bumper for too long, the trunk lid does not open. Repeat the leg movement more quickly if this occurs.

Opening automatically from inside

Important safety notes

WARNING

Combustion engines emit poisonous exhaust gases such as carbon monoxide. Exhaust gases can enter the vehicle interior if the trunk lid is open when the engine is running, especially if the vehicle is in motion. There is a risk of poisoning.

Always switch off the engine before opening the trunk lid. Never drive with the trunk lid open.

- ❗ The trunk lid swings upwards when opened. Therefore, make sure that there is sufficient clearance above the trunk lid.

The opening dimensions of the trunk lid can be found under "Vehicle data" (▷ page 314).

Opening

You can open the trunk lid from the driver's seat when the vehicle is stationary and unlocked.

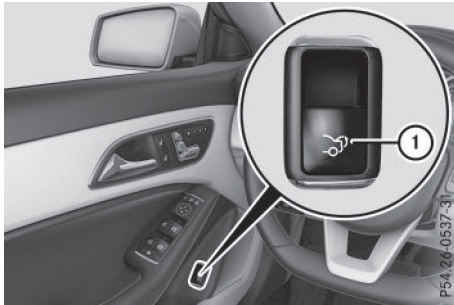

- ▶ **To open:** pull remote operating switch ① for the trunk lid until the trunk lid opens.

Emergency release for the trunk

General notes

- ❗ The trunk lid swings upwards when opened. Therefore, make sure that there is sufficient clearance above the trunk lid.

The opening dimensions of the trunk lid can be found in the "Vehicle data" section (▷ page 314).

If the trunk lid can no longer be unlocked:

- using the SmartKey, or
- using the remote operating switch in the door control panel:

Use the emergency release on the inside of the trunk lid.

You can reach the emergency release via the trunk.

Opening

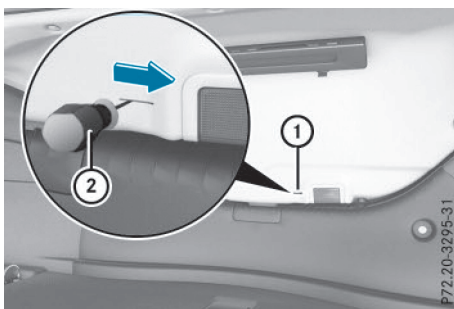

- ▶ Fold the rear seat backrest forwards (▷ page 236).
- ▶ Insert a suitable tool ②, e.g. a screwdriver, into opening ① in the paneling. The trunk lid is released.
- ▶ Open the trunk lid.

Emergency release button

You can open the trunk lid from inside the vehicle with the emergency release button.



- ▶ Press emergency release button ① briefly. The trunk lid unlocks and opens.

The trunk lid can be unlocked and opened with the trunk lid emergency release when the vehicle is stationary or while driving.

The trunk lid emergency release does not open the trunk lid if the battery is disconnected or discharged.

Trunk lid emergency release light:

- Emergency release button ① flashes for 30 minutes after the trunk lid is opened.
- Emergency release button ① flashes for 60 minutes after the trunk lid is closed.

Side windows

Important safety notes

⚠ WARNING

While opening the side windows, body parts could become trapped between the side window and the door frame as the side window moves. There is a risk of injury.

Make sure that nobody touches the side window during the opening procedure. If some-

body becomes trapped, release the switch or pull the switch to close the side window again.

WARNING

While closing the side windows, body parts in the closing area could become trapped. There is a risk of injury.

When closing make sure that no parts of the body are in the closing area. If somebody becomes trapped, release the switch or press the switch to open the side window again.

WARNING

If children operate the side windows they could become trapped, particularly if they are left unsupervised. There is a risk of injury.

Activate the override feature for the rear side windows. When leaving the vehicle, always take the SmartKey with you and lock the vehicle. Never leave children unsupervised in the vehicle.

Side window reversing feature

The side windows are equipped with an automatic reversing feature. If a solid object blocks or restricts a side window from traveling upwards during the automatic closing process, the side window opens again automatically. During the manual closing process, the side window only opens again automatically after the corresponding switch is released. The automatic reversing feature is only an aid and is no substitute for your attention when closing a side window.

WARNING

The reversing feature does not react:

- to soft, light and thin objects, e.g. small fingers
- while resetting

This means that the reversing feature cannot prevent someone being trapped in these situations. There is a risk of injury.

Make sure that no body parts are in close proximity during the closing procedure. If

someone becomes trapped, press the switch to open the side window again.

Opening and closing the side windows

The switches for all side windows are located on the driver's door. There is also a switch on each door for the corresponding side window.

The switches on the driver's door take precedence.

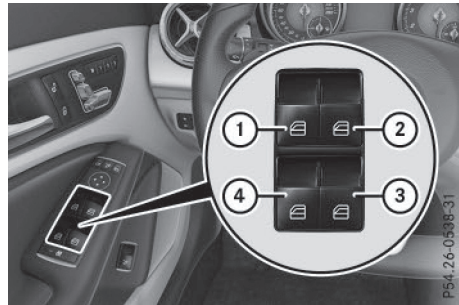

- ① Front left
- ② Front right
- ③ Rear right
- ④ Rear left

► Turn the SmartKey to position **1** or **2** in the ignition lock (▷ page 121).

► **To open manually:** press and hold the corresponding switch.

► **To open fully:** press the switch beyond the point of resistance and release it. Automatic operation is started.

► **To close manually:** pull the corresponding switch and hold it.

► **To close fully:** pull the switch beyond the point of resistance and release it. Automatic operation is started.

► **To interrupt automatic operation:** press/pull the corresponding switch again.

i If you press/pull the switch beyond the point of resistance, automatic operation is started in the corresponding direction. You can stop automatic operation by pressing/pulling the switch again.

i You can continue to operate the side windows after you switch off the engine or remove the SmartKey. This function remains

active for five minutes or until the driver's or front-passenger door is opened.

- i** When the override feature for the side windows is activated (▷ page 59), the side windows cannot be operated from the rear.

Convenience opening

Vehicles with KEYLESS-GO, the KEYLESS-GO start function, Exclusive package or AMG Exclusive package: you can ventilate the vehicle before you start driving.

The SmartKey can also be used to carry out the following functions simultaneously:

- unlock the vehicle
- open the side windows
- open the panorama roof with power tilt/sliding panel and the roller sunblind

The convenience opening feature can only be operated using the SmartKey.



The "convenience opening" feature is also available when the vehicle is unlocked.

- ▶ **Vehicles with Exclusive package or AMG Exclusive package but without KEYLESS-GO and the KEYLESS-GO start function:** for the following operations, point the tip of the SmartKey at the door handle on the driver's door. The SmartKey must be close to the driver's door handle.

- i** **Vehicles with KEYLESS-GO or the KEYLESS-GO start function:** the SmartKey must be in close proximity to the vehicle.

- ▶ Press and hold the  button until the side windows and the panorama sunroof are in the desired position.

If the roller sunblind of the panorama roof with power tilt/sliding panel is closed, the roller sunblind is opened first.

- ▶ Press and hold the  button once more until the panorama roof with power tilt/sliding panel reaches the desired position.
- ▶ **To interrupt convenience opening:** release the  button.

Convenience closing feature

Important safety notes

WARNING

When the convenience closing feature is operating, parts of the body could become trapped in the closing area of the side window and the sliding sunroof. There is a risk of injury.

Observe the complete closing procedure when the convenience closing feature is operating. Make sure that no body parts are in close proximity during the closing procedure.

- ▶ **Vehicles with KEYLESS-GO, the KEYLESS-GO start function, Exclusive Package or AMG Exclusive Package:** at the same time you can:

- lock the vehicle
- close the side windows
- close the panorama roof with power tilt/sliding panel

On vehicles with a panorama roof with power tilt/sliding panel, you can then close the roller sunblind.

- i** Notes on the automatic reversing feature for:

- the side window (▷ page 81)
- the panorama roof with power tilt/sliding panel (▷ page 85)
- the roller sunblind (▷ page 86)



Using the SmartKey

- ▶ **Vehicles with Exclusive package or AMG Exclusive package but without KEYLESS-GO and the KEYLESS-GO start function:** for the following operations, point the tip of the SmartKey at the door handle on the driver's door. The SmartKey must be close to the driver's door handle.

- i** **Vehicles with KEYLESS-GO or the KEYLESS-GO start function:** the SmartKey must be in close proximity to the vehicle.

- ▶ Press and hold the  button until the side windows and the panorama roof with power tilt/sliding panel are fully closed.
- ▶ Make sure that all the side windows and the panorama roof with power tilt/sliding panel are closed.

On vehicles with a panorama roof with power tilt/sliding panel:

- ▶ Press and hold the  button again until the roller sunblind of the panorama roof with power tilt/sliding panel closes.
- ▶ **To interrupt convenience closing:** release the  button.

Using KEYLESS-GO

The driver's door and the door at which the handle is used, must both be closed. The SmartKey must be outside the vehicle. The gap between the SmartKey and the corresponding door handle should not be greater than 3 ft (1 m).



- ▶ Touch recessed sensor surface ① on the door handle until the side windows and the panorama roof with power tilt/sliding panel are fully closed.
- ❗ Make sure you only touch recessed sensor surface ①.
- ▶ Make sure that all the side windows are closed.
- ▶ Make sure that all the side windows and the panorama roof with power tilt/sliding panel are closed.

On vehicles with a panorama roof with power tilt/sliding panel:

- ▶ Touch recessed sensor surface ① on the door handle again until the roller sunblind of the panorama roof with power tilt/sliding panel closes.
- ▶ **To interrupt convenience closing:** release recessed sensor surface ① on the door handle.

Resetting the side windows

If a side window can no longer be closed fully, you must reset it.

- ▶ Close all the doors.
- ▶ Turn the SmartKey to position **1** or **2** in the ignition lock (▷ page 121).
- ▶ Pull the corresponding switch on the door control panel until the side window is completely closed (▷ page 81).
- ▶ Hold the switch for an additional second.

If the side window opens again slightly:

- ▶ Immediately pull the corresponding switch on the door control panel until the side window is completely closed (▷ page 81).
- ▶ Hold the switch for an additional second.
- ▶ If the respective side window remains closed after the button is released, then it has been set correctly. If this is not the case, repeat the steps above again.

Problems with the side windows

WARNING

If you close a side window again immediately after it has been blocked or reset, the side window closes with increased or maximum force. The reversing feature is then not active. Parts of the body could be trapped in the closing area in the process. This poses an increased risk of injury or even fatal injury.

Make sure that no parts of the body are in the closing area. To stop the closing process, release the switch or push the switch again to reopen the side window.

Problem	Possible causes/consequences and ► Solutions
A side window cannot be closed because it is blocked by objects, e.g. leaves in the window guide.	<ul style="list-style-type: none"> ► Remove the objects. ► Close the side window.
A side window cannot be closed and you cannot see the cause.	<p>If a side window is obstructed during closing and reopens again slightly:</p> <ul style="list-style-type: none"> ► Immediately after the window blocks, pull the corresponding switch again until the side window has closed. The side window is closed with increased force. <p>If a side window is obstructed again during closing and reopens again slightly:</p> <ul style="list-style-type: none"> ► Immediately after the window blocks, pull the corresponding switch again until the side window has closed. The side window is closed without the automatic reversing feature.

Panorama roof with power tilt/sliding panel

Important safety notes

In the following section, the term "sliding sunroof" refers to the panorama roof with power tilt/sliding panel.

WARNING

While opening and closing the sliding sunroof, body parts in close proximity could become trapped. There is a risk of injury.

Make sure that no body parts are in close proximity during the opening and closing procedures.

If somebody becomes trapped:

- release the switch immediately, or
- during automatic operation, push the switch briefly in any direction

The opening or closing procedure will be stopped.

WARNING

If children operate the sliding sunroof they could become trapped, particularly if they are left unsupervised. There is a risk of injury.

When leaving the vehicle, always take the SmartKey with you and lock the vehicle. Never leave children unsupervised in the vehicle.

WARNING

At high speeds the raised sliding sunroof automatically lowers slightly at the rear. This could trap you or other persons. There is a risk of injury. Make sure that nobody reaches into the sweep of the sliding sunroof whilst the vehicle is in motion.

If somebody becomes trapped, immediately pull back the sliding sunroof switch. The sliding sunroof lifts during opening.

 Only open the sliding sunroof if it is free of snow and ice. Otherwise, malfunctions may occur.

Do not allow anything to protrude from the sliding sunroof. Otherwise, the seals could be damaged.

 The weather can change abruptly. It could start to rain or snow. Make sure that the sliding sunroof is closed when you leave the vehicle. The vehicle electronics can be damaged if water enters the vehicle interior.

 Resonance noises can occur in addition to the usual airflow noises when the sliding sunroof is open. They are caused by minor pres-

sure fluctuations in the vehicle interior. Change the position of the sliding sunroof or open a side window slightly to reduce or eliminate these noises.

Sliding sunroof reversing feature

In the following section, the term "sliding sunroof" refers to the panorama roof with power tilt/sliding panel.

The sliding sunroof is equipped with an automatic reversing feature. If a solid object blocks or restricts the sliding sunroof during the closing process, the sliding sunroof opens again automatically. However, the automatic reversing feature is only an aid and does not relieve you of the responsibility of paying attention when closing the sliding sunroof.

WARNING

The reversing feature does not react:

- to soft, light and thin objects, e.g. small fingers
- over the last 1/6 in (4 mm) of the closing movement
- during resetting
- when closing the sliding sunroof again manually immediately after automatic reversing

This means that the reversing feature cannot prevent someone being trapped in these situations. There is a risk of injury.

Make sure that no body parts are in close proximity during the closing procedure.

If somebody becomes trapped:

- release the switch immediately, or
- press the switch in any direction during the automatic closing process

The closing process is stopped.

Operating the panorama roof with power tilt/sliding panel

Opening and closing



- ① To raise
- ② To open
- ③ To close/lower

The panorama roof with power tilt/sliding panel can only be operated when the roller sunblind is open.

- ▶ Turn the SmartKey to position 1 or 2 in the ignition lock (> page 121).
- ▶ Press or pull the  switch in the corresponding direction.

If you press/pull the  switch beyond the point of resistance, automatic operation is started in the corresponding direction. You can stop automatic operation by pressing/pulling the switch again.

After opening the sliding sunroof, the roller sunblind closes slightly automatically. This reduces drafts in the vehicle interior.

If the sliding sunroof is raised at the rear, it lowers slightly automatically at higher speeds. The noise level in the vehicle interior is reduced as a result.

At low speeds it raises again automatically.

You can also temporarily deactivate automatic lowering. To do so, press the  switch. The sliding sunroof raises again automatically.

You can continue to operate the sliding sunroof after switching off the engine or removing the SmartKey from the ignition lock. This function remains active for five minutes or until you open a front door.

The sliding sunroof cannot be opened if a roof carrier is installed. In order to allow ventilation of the vehicle interior, you can raise the sliding sunroof.

If contact is made with a roof carrier approved by Mercedes-Benz, the sliding sunroof lowers slightly but remains raised at the rear.

Rain-closing feature

The rain-closing feature is only available for vehicles with a rain sensor.

When the SmartKey is in position **0** in the ignition lock or is removed, the sliding sunroof closes automatically:

- if it starts to rain.
- at extreme outside temperatures.
- after six hours.
- if there is a malfunction in the power supply.

The panorama roof with power tilt/sliding panel remains raised at the rear in order to allow ventilation of the vehicle interior.

If the panorama roof with power tilt/sliding panel is obstructed while being closed by the rain-closing feature, it opens again slightly. The rain-closing feature is then deactivated.

The panorama roof with power tilt/sliding panel does not close if:

- it is raised at the rear.
- it is blocked.
- no rain is falling on the area of the windshield being monitored by the rain sensor. If the vehicle is under a bridge or in a carport, for example, the field of the sensor may be covered.

Operating the roller sunblind for the panorama roof with power tilt/sliding panel

Important safety notes

WARNING

Parts of the body could become trapped between the roller sunblind and frame or sliding sunroof during automatic opening or closing. There is a risk of injury.

When opening or closing, make sure that no body parts are in the sweep of the roller sunblind.

If somebody becomes trapped:

- release the switch immediately, or
- during automatic operation, push the switch briefly in any direction

The opening or closing procedure will be stopped.

The roller sunblind shields the vehicle interior from sunlight. The roller sunblind can only be opened and closed when the panorama roof with power tilt/sliding panel is closed.

Roller sunblind reversing feature

The roller sunblind is equipped with an automatic reversing feature. If a solid object blocks or restricts the roller sunblind during the closing process, the roller sunblind opens again automatically. However, the automatic reversing feature is only an aid and does not relieve you of the responsibility of paying attention when closing the roller sunblind.

WARNING

The reversing feature does not react:

- to soft, light and thin objects, e.g. small fingers
- when closing the roller sunblind again manually immediately after automatic reversal

This means that the reversing feature cannot prevent someone being trapped in these situations. There is a risk of injury.

When closing the roller sunblind, make sure that no body parts are in the sweep area.

If somebody becomes trapped:

- release the switch immediately, or
- press the switch in any direction during the automatic closing process

The closing process is stopped.

Opening and closing

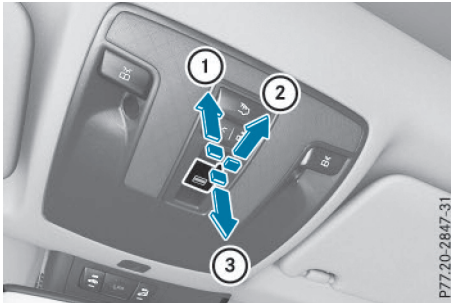

- ① To open
- ② To open
- ③ To close

- ▶ Turn the SmartKey to position **1** or **2** in the ignition lock (▷ page 121).
- ▶ Press or pull the  switch in the corresponding direction.



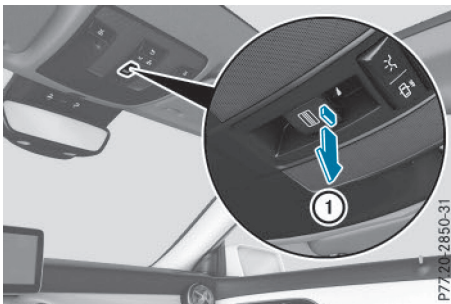

If you press/pull the  switch beyond the point of resistance, automatic operation is started in the corresponding direction. You can stop automatic operation by pressing/pulling the switch again.

After opening the panorama roof with power tilt/sliding panel, the roller sunblind automatically closes slightly. This reduces drafts in the vehicle interior.

Resetting the panorama roof with power tilt/sliding panel or the roller sunblind



Reset the panorama roof with power tilt/sliding panel or the roller sunblind, if the panorama roof with power tilt/sliding panel or the roller sunblind does not move smoothly.



- ▶ Turn the SmartKey to position **1** or **2** in the ignition lock (▷ page 121).
- ▶ Pull the  button repeatedly to the point of resistance in the direction of arrow ① until the panorama roof with power tilt/sliding panel is fully closed.
- ▶ Keep the  switch pulled for an additional second.
- ▶ Pull the  switch repeatedly to the point of resistance in the direction of arrow ① until the roller sunblind is fully closed.
- ▶ Keep the  switch pulled for an additional second.
- ▶ Make sure that the panorama roof with power tilt/sliding panel and the roller sunblind can be fully opened and closed again.
- ▶ If this is not the case, repeat the steps above.

Problems with the panorama roof with power tilt/sliding panel **WARNING**

If you do not reset the sliding sunroof after a malfunction or voltage supply interruption, then the backing up function will malfunction or not work. The sliding sunroof closes with increased or maximum force. Parts of the body could be trapped in the closing area in the process. This poses an increased risk of injury or even fatal injury.

In such or similar situations always make sure that no parts of the body are in the closing area. Always reset the sliding sunroof after a malfunction or voltage supply interruption.

 If the sliding sunroof still cannot be opened or closed as a result of a malfunction, contact a qualified specialist workshop.

Problem	Possible causes/consequences and ► Solutions
The panorama roof with power tilt/sliding panel cannot be closed and you cannot see the cause.	<p>If the panorama roof with power tilt/sliding panel is obstructed during closing and reopens again slightly:</p> <ul style="list-style-type: none"> ► Immediately after it blocks, pull the  switch down again to the point of resistance until the panorama roof with power tilt/sliding panel is closed. The panorama roof with power tilt/sliding panel is closed with more force. <p>If the panorama roof with power tilt/sliding panel is obstructed again during closing and reopens again slightly:</p> <ul style="list-style-type: none"> ► Immediately after it blocks, pull the  switch down again to the point of resistance until the panorama roof with power tilt/sliding panel is closed. The panorama roof with power tilt/sliding panel is closed without the automatic reversing feature.

Correct driver's seat position

WARNING

You could lose control of your vehicle if you do the following while driving:

- adjust the driver's seat, head restraint, steering wheel or mirrors
- fasten the seat belt

There is a risk of an accident.

Adjust the driver's seat, head restraint, steering wheel and mirror and fasten your seat belt before starting the engine.



Observe the following when adjusting steering wheel ①, seat belt ② and driver's seat ③:

- you are as far away from the driver's air bag as possible
- you are sitting in a normal upright position
- your thighs are slightly supported by the seat cushion
- your legs are not entirely stretched and you can depress the pedals properly
- the back of your head is supported at eye level by the center of the head restraint
- you can hold the steering wheel with your arms slightly bent
- you can move your legs freely
- you can see all the displays in the instrument cluster clearly

- you should have a good overview of traffic conditions
- the seat belt is pulled snugly against the body and is routed across the center of your shoulder and across your hips in the pelvic area

Further related subjects:

- Adjusting the seats manually (▷ page 90)
- Adjusting the seats electrically (▷ page 91)
- Adjusting the steering wheel manually (▷ page 94)
- Fastening the seat belt correctly (▷ page 43)
- Adjusting the rear-view mirror and exterior mirrors (▷ page 95)
- **Vehicles with a memory function:** saving the seat, steering wheel and exterior mirror settings using the memory function (▷ page 97)

Seats

Important safety notes

WARNING

Children could become trapped if they adjust the seats, particularly when unattended.

There is a risk of injury.

When leaving the vehicle, always take the SmartKey with you and lock the vehicle. Never leave children unsupervised in the vehicle.

The seats can still be adjusted when there is no SmartKey in the ignition lock.

WARNING

When you adjust a seat, you or other vehicle occupants could become trapped, e.g. on the seat guide rail. There is a risk of injury.

Make sure when adjusting a seat that no one has any body parts in the sweep of the seat.

Observe the safety notes on "Air bags" (▷ page 44) and "Children in the vehicle" (▷ page 53).

WARNING

If the driver's seat is not engaged, it could move unexpectedly while the vehicle is in

motion. This could cause you to lose control of the vehicle. There is a risk of an accident. Always make sure that the driver's seat is engaged before starting the vehicle.

WARNING

You could lose control of your vehicle if you do the following while driving:

- adjust the driver's seat, head restraint, steering wheel or mirrors
- fasten the seat belt

There is a risk of an accident.

Adjust the driver's seat, head restraint, steering wheel and mirror and fasten your seat belt before starting the engine.

WARNING

If you adjust the seat height carelessly, you or other vehicle occupants could be trapped and thereby injured. Children in particular could accidentally press the electrical seat adjustment buttons and become trapped. There is a risk of injury.

While moving the seats, make sure that your hands or other body parts do not get under the lever assembly of the seat adjustment system.

! To avoid damage to the seats and the seat heating, observe the following information:

- keep liquids from spilling on the seats. If liquid is spilled on the seats, dry them as soon as possible.
- if the seat covers are damp or wet, do not switch on the seat heating. The seat heating should also not be used to dry the seats.
- clean the seat covers as recommended; see the "Interior care" section.
- do not transport heavy loads on the seats. Do not place sharp objects on the seat cushions, e.g. knives, nails or tools. The seats should only be occupied by passengers, if possible.
- when the seat heating is in operation, do not cover the seats with insulating materials, e.g. blankets, coats, bags, seat covers, child seats or booster seats.

! Make sure that there are no objects in the footwell under or behind the seats when moving the seats back. There is a risk that the seats and/or the objects could be damaged.

i Further related subjects:

- cargo compartment enlargement (folding down the rear seats) (▷ page 236)

Adjusting the seats manually

Vehicles without the seating comfort package



Seat fore-and-aft adjustment:

- ▶ Lift handle ① and slide the seat forwards or backwards.
- ▶ Release lever ② again. Make sure that you hear the seat engage in position.

Backrest angle:

- ▶ Relieve the pressure on the backrest.
- ▶ Turn handwheel ③ forwards or backwards.

Seat height:

- ▶ Pull handle ② upwards or push it down repeatedly until the seat has reached the desired height.

Vehicles with the seating comfort package



Seat fore-and-aft adjustment:

- ▶ Lift handle ① and slide the seat forwards or rearwards.
- ▶ Release lever ① again. Make sure that you hear the seat engage in position.

Backrest angle:

- ▶ Relieve the pressure on the backrest.
- ▶ Turn handwheel ⑤ forwards or backwards.

Seat height:

- ▶ Pull handle ④ upwards or push it down repeatedly until the seat has reached the desired height.

Seat cushion angle:

- ▶ Adjust the angle so that your thighs are lightly supported.
- ▶ Turn handwheel ③ forwards or backwards.

Seat cushion length:

- ▶ Lift handle ② and slide the front part of the seat cushion forwards or backwards.
- ▶ Release lever ② again. The seat cushion engages.

Adjusting the seats electrically

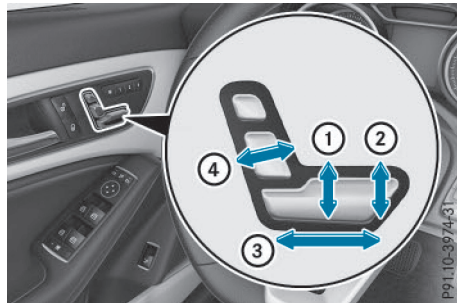

- ① Seat height
- ② Seat cushion angle
- ③ Seat fore-and-aft adjustment
- ④ Backrest angle
- ⓘ You can store the seat settings using the memory function (> page 97).

Adjusting the head restraints

Important safety notes

⚠ WARNING

You could lose control of your vehicle if you do the following while driving:

- adjust the driver's seat, head restraint, steering wheel or mirrors
- fasten the seat belt

There is a risk of an accident.

Adjust the driver's seat, head restraint, steering wheel and mirror and fasten your seat belt before starting the engine.

⚠ WARNING

If the head restraints are not installed or not adjusted correctly, they cannot provide protection as intended. There is an increased risk of injury in the head and neck area, e.g. in the event of an accident or when braking.

Always drive with the head restraints installed. Before driving off, make sure for every vehicle occupant that the center of the head restraint supports the back of the head at about eye level.

Using the fore-and-aft adjustment, adjust the head restraint so that it is as close as possible to your head.

General notes

For vehicles with sports seats you cannot adjust the front head restraints or the outer rear head restraints.

Adjusting the head restraints manually

Adjusting the head restraint height

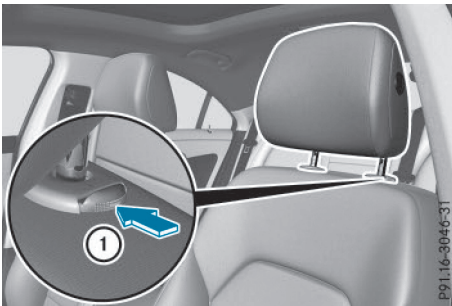

- ▶ **To raise:** pull the head restraint up to the desired position.
- ▶ **To lower:** press release catch ① in the direction of the arrow and push the head restraint down to the desired position.

Adjusting the fore/aft position of the head restraint

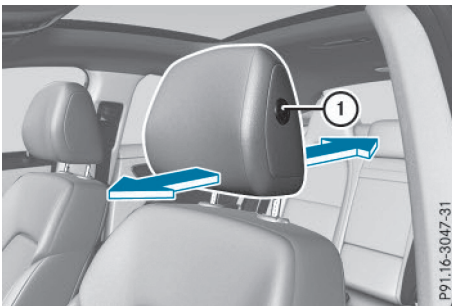

With this function you can adjust the distance between the head restraint and the back of the seat occupant's head.

- ▶ **To move forwards:** pull the head restraint forwards in the direction of the arrow until it engages. There are several notches.
- ▶ **To move backwards:** press and hold release button ① and push the head restraint backwards.
- ▶ When the head restraint is in the desired position, release the button and make sure that the head restraint is engaged in position.

Rear seat head restraints

Adjusting the rear seat head restraint height

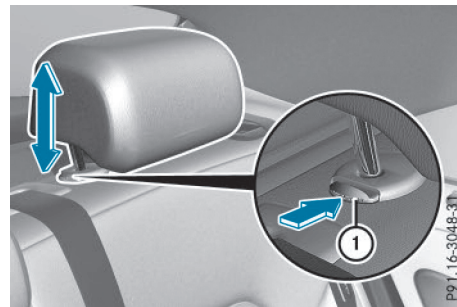

- ▶ **To raise:** pull the head restraint up to the desired position.
- ▶ **To lower:** press release catch ① and push the head restraint down until it is in the desired position.

Adjusting the 4-way lumbar support

You can adjust the contour of the front seat backrests individually to provide optimum support for your back.

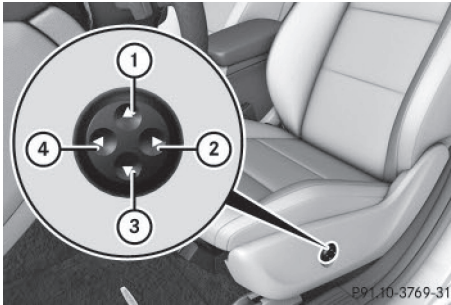

- ① Raises the backrest contour
- ② Softens the backrest contour
- ③ Lowers the backrest contour
- ④ Hardens the backrest contour

AMG Performance Seat

Vehicles with electrically adjustable seats: to adjust the contour of the seat and for improved lateral support, you can individually adjust the front seats.

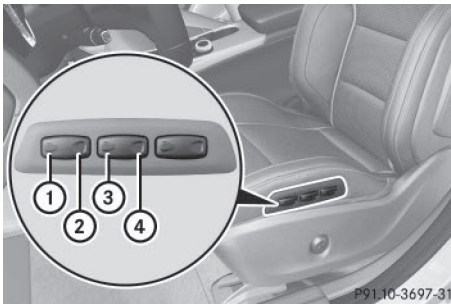

Adjusting the side bolsters of the seat cushion

- ▶ **To set the side bolsters of the seat cushion narrower:** press button ①.
- ▶ **To set the side bolsters of the seat cushion wider:** press button ②.

Adjusting the side bolsters of the seat backrest

- ▶ **To set the side bolsters of the seat backrest narrower:** press button ③.
- ▶ **To set the side bolsters of the seat backrest wider:** press button ④.

Switching the seat heating on/off

Switching on/off

WARNING

Repeatedly switching on the seat heating can cause the seat cushion and backrest pads to become very hot. The health of persons with limited temperature sensitivity or a limited ability to react to excessively high temperatures may be affected or they may even suffer burn-like injuries. There is a risk of injury. Therefore, do not switch the seat heating on repeatedly.

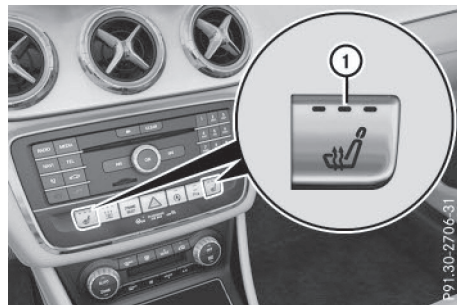

The three red indicator lamps in the button indicate the heating level you have selected.

The system automatically switches down from level 3 to level 2 after approximately eight minutes.

The system automatically switches down from level 2 to level 1 after approximately ten minutes.

The system automatically switches off approximately 20 minutes after it is set to level 1.

- ▶ Turn the SmartKey to position 1 or 2 in the ignition lock (▶ page 121).
- ▶ **To switch on:** press button ① repeatedly until the desired heating level is set.
- ▶ **To switch off:** press button ① repeatedly until all the indicator lamps go out.

i If the battery voltage is too low, the seat heating may switch off.

Problems with the seat heating

Problem	Possible causes/consequences and ► Solutions
The seat heating has switched off prematurely or cannot be switched on.	<p>The on-board voltage is too low because too many electrical consumers are switched on.</p> <p>► Switch off electrical consumers that you do not need, such as the rear window defroster or interior lighting.</p> <p>Once the battery is sufficiently charged, the seat heating will switch back on automatically.</p>

Steering wheel

Important safety notes

WARNING

You could lose control of your vehicle if you do the following while driving:

- adjust the driver's seat, head restraint, steering wheel or mirrors
- fasten the seat belt

There is a risk of an accident.

Adjust the driver's seat, head restraint, steering wheel and mirror and fasten your seat belt before starting the engine.

WARNING

Children could injure themselves if they adjust the steering wheel. There is a risk of injury.

When leaving the vehicle, always take the SmartKey with you and lock the vehicle. Never leave children unsupervised in the vehicle.

Adjusting the steering wheel

WARNING

If the steering wheel is unlocked while the vehicle is in motion, it could change position unexpectedly. This could cause you to lose control of the vehicle. There is a risk of an accident.

Before starting off, make sure the steering wheel is locked. Never unlock the steering wheel while the vehicle is in motion.

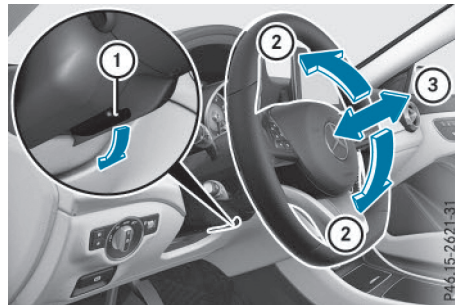

- ① Release lever
- ② Adjusts the steering wheel height
- ③ Adjusts the steering wheel position (fore-and-aft adjustment)

- Push release lever ① down completely. The steering column is unlocked.
- Adjust the steering wheel to the desired position.
- Push release lever ① up completely. The steering column is locked.
- Check if the steering column is locked. When doing so, try to push the steering wheel up or down or try to move it in the fore-and-aft direction.

Mirrors

Rear-view mirror



- ▶ **Anti-glare mode:** flick anti-glare lever ① forwards or back.

Exterior mirrors

Adjusting the exterior mirrors

WARNING

You could lose control of your vehicle if you do the following while driving:

- adjust the driver's seat, head restraint, steering wheel or mirrors
- fasten the seat belt

There is a risk of an accident.

Adjust the driver's seat, head restraint, steering wheel and mirror and fasten your seat belt before starting the engine.

WARNING

The exterior mirror on the front-passenger side reduces the size of the image. Visible objects are actually closer than they appear. This means that you could misjudge the distance from road users traveling behind, e.g. when changing lane. There is a risk of an accident.

For this reason, always make sure of the actual distance from the road users traveling behind by glancing over your shoulder.

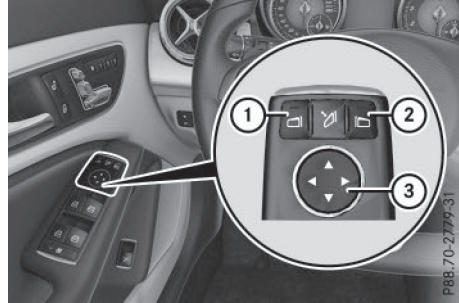

- ▶ Turn the SmartKey to position 1 or 2 in the ignition lock (▷ page 121).
- ▶ Exterior mirror on the front-passenger side: press button ②.
Exterior mirror on the driver's side: press button ①.
The indicator lamp in the corresponding button lights up in red.
The indicator lamp goes out again after some time. You can adjust the selected exterior mirror using button ③ as long as the indicator lamp is lit.
- ▶ Press button ③ up, down, or to the right or left until you have adjusted the exterior mirror to the correct position. You should have a good overview of traffic conditions.

The convex exterior mirrors provide a larger field of vision.

After the engine has been started, the exterior mirrors are automatically heated at low outside temperatures. Heating takes a maximum of ten minutes.

- i** You can also heat up the exterior mirrors manually by switching on the rear window defroster.

Folding the exterior mirrors in or out electrically

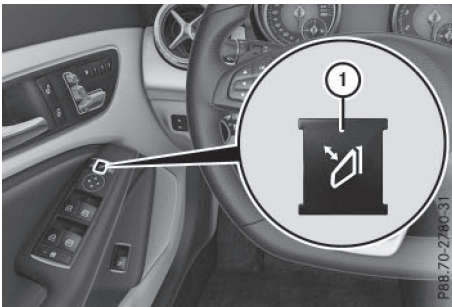

- ▶ Turn the SmartKey to position **1** or **2** in the ignition lock (▷ page 121).
- ▶ Briefly press **1**. Both exterior mirrors fold in or out.
- i** Make sure that the exterior mirrors are always folded out fully while driving. They could otherwise vibrate.
- i** If you are driving faster than 30 mph (47 km/h), you can no longer fold in the exterior mirrors.

Resetting the exterior mirrors

If the battery has been disconnected or completely discharged, the exterior mirrors must be reset. The exterior mirrors will otherwise not fold in when you select the "Fold in mirrors when locking" function in the on-board computer (▷ page 185).

- ▶ Turn the SmartKey to position **1** in the ignition lock (▷ page 121).
- ▶ Briefly press **1**.

Folding the exterior mirrors in or out automatically

If the "Fold in mirrors when locking" function is activated in the on-board computer (▷ page 185):

- the exterior mirrors fold in automatically as soon as you lock the vehicle from the outside.
- the exterior mirrors fold out again automatically as soon as you unlock the vehicle and then open the driver's or front-passenger door.

- i** If the exterior mirrors have been folded in manually, they do not fold out.

Exterior mirror pushed out of position

If an exterior mirror has been pushed out of position, proceed as follows:

- ▶ **Vehicles without electrically folding exterior mirrors:** move the exterior mirror into the correct position manually.
- ▶ **Vehicles with electrically folding exterior mirrors:** press and hold mirror-folding button (▷ page 96) until you hear the mirror click into place. The mirror housing is engaged again and you can adjust the exterior mirrors as usual (▷ page 95).

Automatic anti-glare mirrors

⚠ WARNING

Electrolyte may escape if the glass in an automatic anti-glare mirror breaks. The electrolyte is harmful and causes irritation. It must not come into contact with your skin, eyes, respiratory organs or clothing or be swallowed. There is a risk of injury.

If you come into contact with the electrolyte, observe the following:

- Rinse off the electrolyte from your skin immediately with water.
- Immediately rinse the electrolyte out of your eyes thoroughly with clean water.
- If the electrolyte is swallowed, immediately rinse your mouth out thoroughly. Do not induce vomiting.
- If electrolyte comes into contact with your skin or hair or is swallowed, seek medical attention immediately.
- Immediately change out of clothing which has come into contact with electrolyte.
- If an allergic reaction occurs, seek medical attention immediately.

The "Automatic anti-glare mirrors" function is only available if the vehicle is equipped with the "Mirrors package".

The rear-view mirror and the exterior mirror on the driver's side automatically go into anti-glare mode if:

- the ignition is switched on and
- incident light from headlamps strikes the sensor in the rear-view mirror

The mirrors do not go into anti-glare mode if reverse gear is engaged or if the interior lighting is switched on.

Parking position for the exterior mirror on the front-passenger side

Setting and storing the parking position

You can set the front-passenger side exterior mirror such that you can see the rear wheel on that side as soon as you engage reverse gear. You can store this position.

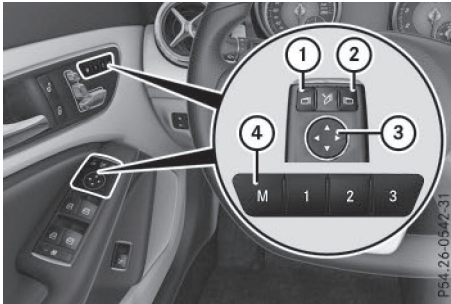

- ① Button for the driver's side exterior mirror
- ② Button for the front-passenger side exterior mirror
- ③ Button for the exterior mirror setting
- ④ Memory button **M**

- ▶ Make sure that the vehicle is stationary.
- ▶ Turn the SmartKey to position **2** in the ignition lock (▷ page 121).
- ▶ Press button ②.
- ▶ Engage reverse gear.
The exterior mirror on the front-passenger side moves to the default parking position.
- ▶ Use button ③ to adjust the exterior mirror to a position that allows you to see the rear wheel and the curb.
The parking position is stored.

- i** If you shift the transmission to another position, the front-passenger side exterior mirror returns to the driving position.

Calling up a stored parking position setting

- ▶ Turn the SmartKey to position **2** in the ignition lock (▷ page 121).
- ▶ Adjust the front-passenger side exterior mirror using the corresponding button (▷ page 95).
- ▶ Engage reverse gear.
The exterior mirror on the front-passenger side moves to the stored parking position.

The exterior mirror on the front-passenger side moves back to its original position:

- as soon as you exceed a speed of 9 mph (15 km/h)
- about ten seconds after you have disengaged reverse gear
- when you use button ① to select the exterior mirror on the driver's side

Memory function

Important safety notes

⚠ WARNING

If you use the memory function on the driver's side while driving, you could lose control of the vehicle as a result of the adjustments being made. There is a risk of an accident. Only use the memory function on the driver's side when the vehicle is stationary.

⚠ WARNING

When the memory function adjusts the seat, you and other vehicle occupants – particularly children – could become trapped. There is a risk of injury.

While the memory function is making adjustments, make sure that no one has any body parts in the sweep of the seat. If somebody becomes trapped, immediately release the memory function position button. The adjustment process is stopped.

⚠ WARNING

Children could become trapped if they activate the memory function, particularly when unattended. There is a risk of injury.

When leaving the vehicle, always take the SmartKey with you and lock the vehicle. Never leave children unsupervised in the vehicle.

The memory function can be used at any time, e.g. even when the SmartKey is not in the ignition lock.

Storing settings

With the memory function, you can store up to three different settings, e.g. for three different people.

The following settings are stored as a single memory preset:

- seat and backrest position
- driver's side: position of the exterior mirrors on the driver's and front-passenger sides



- ▶ Adjust the seat (▷ page 91).
- ▶ Adjust the exterior mirror on the driver's side (▷ page 95).
- ▶ Briefly press the **M** memory button and then press preset position button **1**, **2** or **3** within three seconds.

The settings are stored in the selected preset position. A tone sounds when the settings have been completed.

Calling up a stored setting

- ▶ Press and hold the relevant preset position button **1**, **2** or **3** until the seat and exterior mirrors are in the stored position.

i The setting procedure is interrupted as soon as you release the storage position button.

Exterior lighting

General notes

For reasons of safety, Mercedes-Benz recommends that you drive with the lights switched on even during the daytime. In some countries, operation of the headlamps varies due to legal requirements and self-imposed obligations.

Setting the exterior lighting

Setting options

Exterior lighting can be set using the:

- light switch
- combination switch (▷ page 100)
- on-board computer (▷ page 184)

Light switch

Operation

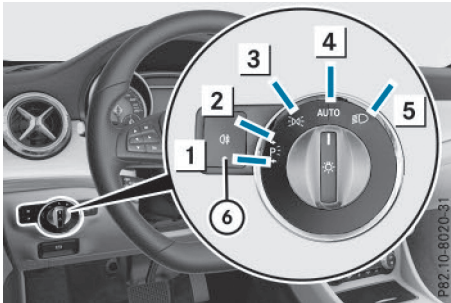

- 1 Left-hand standing lamps
- 2 Right-hand standing lamps
- 3 Parking lamps, license plate and instrument cluster lighting
- 4 Automatic headlamp mode, controlled by the light sensor
- 5 Low-beam/high-beam headlamps
- 6 Rear fog lamp

If you hear a warning tone when you leave the vehicle, the lights may still be switched on.

- ▶ Turn the light switch to the **AUTO** position.

The exterior lighting (except the parking/standing lamps) switches off automatically if you:

- remove the SmartKey from the ignition lock
- open the driver's door with the SmartKey in position **0** in the ignition lock

Automatic headlamp mode

AUTO is the favored light switch setting. The light setting is automatically selected according to the brightness of the ambient light (exception: poor visibility due to weather conditions such as fog, snow or spray):

- SmartKey in position **1** in the ignition lock: the parking lamps are switched on/off automatically depending on the brightness of the ambient light.
- With the engine running: if you have switched on the **Daytime Running Lights** function via the on-board computer, the daytime running lamps or the parking lamps and low-beam headlamps are switched on or off automatically depending on the brightness of the ambient light.

- ▶ **To switch on the automatic headlamp mode:** turn the light switch to the **AUTO** position.

WARNING

When the light switch is set to **AUTO**, the low-beam headlamps may not be switched on automatically if there is fog, snow or other causes of poor visibility due to the weather conditions such as spray. There is a risk of an accident.

In such situations, turn the light switch to .

The automatic headlamp feature is only an aid. The driver is responsible for the vehicle's lighting at all times.

Canada only:

The daytime running lamps improve the visibility of your vehicle during the day. The daytime running lamps function is required by law in Canada. It cannot therefore be deactivated.

When the engine is running and the vehicle is stationary: if you move the selector lever from a drive position to **P**, the daytime running lamps/low-beam headlamps go out after three minutes.



When the engine is running, the vehicle is stationary and in bright ambient light: if you turn the light switch to the position, the daytime running lamps and parking lamps are switched on.

If the engine is running and you turn the light switch to the position, the manual settings

take precedence over the daytime running lamps.



USA only:

The daytime running lamps improve the visibility of your vehicle during the day. To do this, the daytime running lamps function must be switched on using the on-board computer (▷ page 184).

If the engine is running and you turn the light switch to the  or  position, the manual settings take precedence over the daytime running lamps.





Low-beam headlamps

Even if the light sensor does not detect that it is dark, the parking lamps and low-beam headlamps come on when the ignition is switched on and the light switch is set to the  position. This is a particularly useful function in the event of rain and fog.

- ▶ **To switch on the low-beam headlamps:** turn the SmartKey in the ignition lock to position **2** or start the engine.
- ▶ Turn the light switch to . The green  indicator lamp in the instrument cluster lights up.

Rear fog lamp



The rear fog lamp improves visibility of your vehicle for the traffic behind in the event of thick fog. Please take note of the country-specific regulations for the use of rear fog lamps.



- ▶ **To switch on the rear fog lamp:** turn the SmartKey in the ignition lock to position **2** or start the engine.
- ▶ Turn the light switch to  or **AUTO**.
- ▶ Press the  button. The yellow  indicator lamp in the instrument cluster lights up.
- ▶ **To switch off the rear fog lamp:** press the  button. The yellow  indicator lamp in the instrument cluster goes out.

i When the rear fog lamp is switched on, the center brake lamp in the tail lamp switches off due to a legal requirement.

Parking lamps



! If the battery charge is very low, the parking lamps or standing lamps are automatically switched off to enable the next engine start.

Always park your vehicle safely and in a well lit area, in accordance with the relevant legal stipulations. Avoid using the  parking lamps over a period of several hours. If possible, switch on the right-hand  or left-hand  standing lamps.

- ▶ **To switch on:** turn the light switch to . The green  indicator lamp in the instrument cluster lights up.

Standing lamps

Switching on the standing lamps ensures the corresponding side of the vehicle is illuminated.

- ▶ **To switch on the standing lamps:** the SmartKey should not be in the ignition lock or it should be in position **0**.
- ▶ Turn the light switch to  (left-hand side of the vehicle) or  (right-hand side of the vehicle).

Combination switch

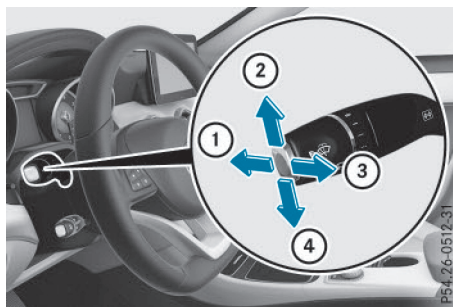

- ▶ **To indicate briefly:** press the combination switch briefly to the pressure point in the direction of arrow **2** or **4**. The corresponding turn signal flashes three times.
- ▶ **To indicate:** press the combination switch beyond the pressure point in the direction of arrow **2** or **4**.
- ▶ **To switch on the high-beam headlamps:** turn the light switch to  or **AUTO**.
- ▶ Press the combination switch beyond the pressure point in the direction of arrow **1**. The high-beam headlamps only switch on in the **AUTO** position if the low-beam headlamps are on.

The blue  indicator lamp in the instrument cluster lights up when the high-beam headlamps are switched on.

- ▶ **To switch off the high-beam headlamps:** move the combination switch back to its normal position.

The blue  indicator lamp in the instrument cluster goes out.

Vehicles with Adaptive Highbeam Assist: when Adaptive Highbeam Assist is active, it controls activation and deactivation of the high-beam headlamps (▶ page 101).

- ▶ **To switch on the high-beam flasher:** pull the combination switch in the direction of arrow ③.

Hazard warning lamps



- ▶ **To switch on the hazard warning lamps:** press button ①. All turn signals flash. If you now switch on a turn signal using the combination switch, only the turn signal lamp on the corresponding side of the vehicle will flash.
- ▶ **To switch off the hazard warning lamps:** press button ①.

The hazard warning lamps automatically switch on if:

- an air bag is deployed or
- the vehicle decelerates rapidly from a speed of above 45 mph (70 km/h) and comes to a standstill

The hazard warning lamps switch off automatically if the vehicle reaches a speed of above 6 mph (10 km/h) again after a full brake application.

The hazard warning lamps still operate if the ignition is switched off.

Adaptive Highbeam Assist

General notes

You can use this function to set the headlamps to change between low beam and high beam automatically. The system recognizes vehicles with their lights on, either approaching from the opposite direction or traveling in front of your vehicle, and consequently switches the headlamps from high beam to low beam. Once the system no longer detects any other vehicles, it reactivates the high-beam headlamps.

The system's optical sensor is located behind the windshield near the overhead control panel.

Important safety notes

WARNING

Adaptive Highbeam Assist does not recognize road users:

- who have no lights, e.g. pedestrians
- who have poor lighting, e.g. cyclists
- whose lighting is blocked, e.g. by a barrier

On very rare occasions, Adaptive Highbeam Assist may fail to recognize other road users that have lights, or may recognize them too late. In this, or in similar situations, the automatic high-beam headlamps will not be deactivated or will be activated regardless. There is a risk of an accident.

Always carefully observe the traffic conditions and switch off the high-beam headlamps in good time.

Adaptive Highbeam Assist cannot take into account road, weather or traffic conditions. Adaptive Highbeam Assist is only an aid. You are responsible for adjusting the vehicle's lighting to the prevailing light, visibility and traffic conditions.

In particular, the detection of obstacles can be restricted if there is:

- poor visibility, e.g. due to fog, heavy rain or snow
- dirt on the sensors or the sensors are obscured

Switching Adaptive Highbeam Assist on/off



► **To switch on:** turn the light switch to **AUTO**.

► Press the combination switch beyond the pressure point in the direction of arrow ①. The  indicator lamp in the multifunction display lights up when it is dark and the light sensor activates the low-beam headlamps.

If you are driving at speeds above approximately 19 mph (30 km/h) and no other road users are detected:

The high-beam headlamps are switched on automatically. The  indicator lamp in the instrument cluster also lights up.

If you are driving at speeds below approximately 16 mph (25 km/h) or other road users have been detected or the roads are adequately lit:

The high-beam headlamps are switched off automatically. The  indicator lamp in the instrument cluster goes out. The  indicator lamp in the multifunction display remains lit.

► **To switch off:** move the combination switch back to its normal position.

The  indicator lamp in the multifunction display goes out.

Headlamps fogged up on the inside





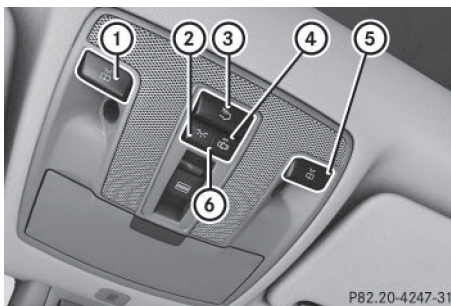

Certain climatic and physical conditions may cause moisture to form in the headlamp. This moisture does not affect the functionality of the headlamp.

Interior lighting

Overview of interior lighting



Front overhead control panel

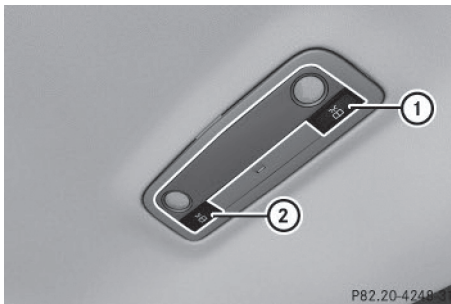

- ①  Switches the left-hand front reading lamp on or off
- ②  Switches the front interior lighting on
- ③  Switches the rear interior lighting on or off
- ④  Switches the front interior lighting/automatic interior lighting control off
- ⑤  Switches the right-hand front reading lamp on or off
- ⑥  Switches the automatic interior lighting control on

Rear compartment control panel



- ①  Switches the left-hand reading lamp on/off
- ②  Switches the right-hand reading lamp on/off

Interior lighting control

General notes

In order to prevent the vehicle's battery from discharging, the interior lighting functions are automatically deactivated after some time except when the SmartKey is in position **2** in the ignition lock.

The color and brightness for the ambient lighting may be set via the multimedia system; see the separate operating instructions.

Automatic interior lighting control

- ▶ **To switch on:** set the switch to center position ⑥.
- ▶ **To switch off:** set the switch to the  position.

The interior lighting automatically switches on if you:

- unlock the vehicle
- open a door
- remove the SmartKey from the ignition lock

The interior light is activated for a short while when the SmartKey is removed from the ignition lock. This delayed switch-off can be adjusted via the multimedia system; see the separate operating instructions.

Replacing bulbs

Important safety notes

WARNING

Bulbs, lamps and connectors can get very hot when operating. If you change a bulb, you could burn yourself on these components. There is a risk of injury.

Allow these components to cool down before changing a bulb.

Do not use a bulb if it has been dropped or if its glass tube has been scratched.

The bulb may explode if

- you touch it
- it is hot
- you drop it
- you scratch it.

Use bulbs only in closed lamps that have been designed for this purpose. Only install spare bulbs of the same type and the specified voltage.

Marks on the glass tube reduce the service life of the bulbs. Do not touch the glass tube with your bare hands. If necessary, clean the glass tube when cold with alcohol or spirit and rub it off with a lint-free cloth.

Protect bulbs from moisture during operation. Do not allow bulbs to come into contact with liquids.

Replace only the bulbs listed (▷ page 103). Have the bulbs that you cannot change yourself replaced at a qualified specialist workshop.

If you require assistance replacing bulbs, consult a qualified specialist workshop.

If the new bulb still does not light up, consult a qualified specialist workshop.

Headlamps and lights are an important aspect of vehicle safety. You must therefore make sure that these function correctly at all times. Have the headlamp setting checked regularly.

Vehicles with LED headlamps: the light clusters of your vehicle are equipped with LED light bulbs. Do not replace the bulbs yourself. Contact a qualified specialist workshop which has the necessary specialist knowledge and tools to carry out the work required.

Overview of bulb types

You can replace the following bulbs. The bulb type can be found in the legend.



Vehicles with halogen headlamps

- ① Turn signal lamp: PY 21 W
- ② High-beam headlamps/daytime running lamps/parking lamps/standing lamps: H15 55 W/15 W
- ③ Low-beam headlamps: H7 55 W

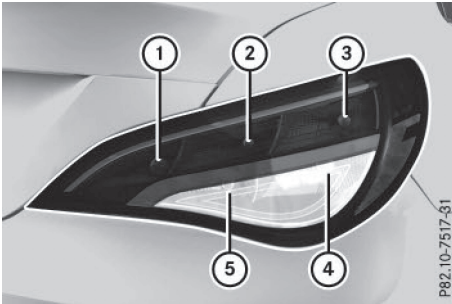

Tail lamps (vehicles with halogen headlamps)

- ① Rear fog lamp: P 21 W
- ② Brake lamp: W 16 W
- ③ Brake lamp: W 16 W
- ④ Turn signal lamp: PY 21 W
- ⑤ Backup lamp: W 16 W

Replacing front bulbs

Removing and installing the cover in the front wheel housing

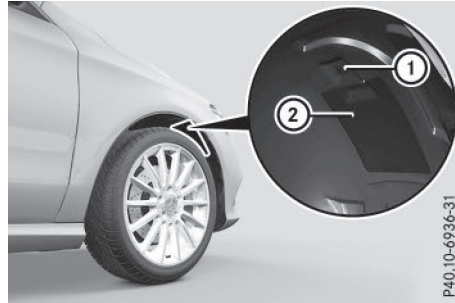

You must remove the cover of the front wheel housing before you can change the front turn signal lamp.

- ▶ **To remove:** switch off the lights.
- ▶ Turn the front wheels inwards.
- ▶ Turn rotary knob ① through 90°.
- ▶ Cover ② is released.
- ▶ Push cover ② down.
- ▶ **To install:** push cover ② up.
- ▶ Turn rotary knob ① through 90°.
- ▶ Cover ② is locked.

Low-beam headlamps (halogen headlamps)

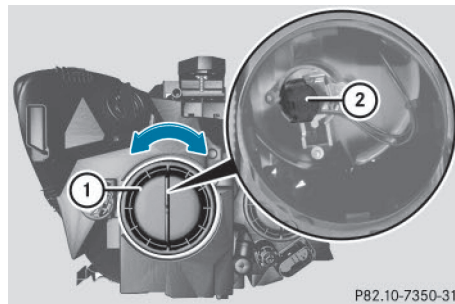

- ▶ Remove the cover in the front wheel housing (▷ page 104).
- ▶ Turn housing cover ① counter-clockwise and remove it.
- ▶ Turn bulb holder ② counter-clockwise and pull out.
- ▶ Pull the bulb out of bulb holder ②.

- ▶ Insert the new bulb into bulb holder ②.
- ▶ Insert bulb holder ② and turn it clockwise.
- ▶ Press on housing cover ① and turn it to the right.
- ▶ Replace the cover in the front wheel housing (▷ page 104).

High-beam headlamps/daytime running lamps/parking lamps and standing lamps (halogen headlamps)

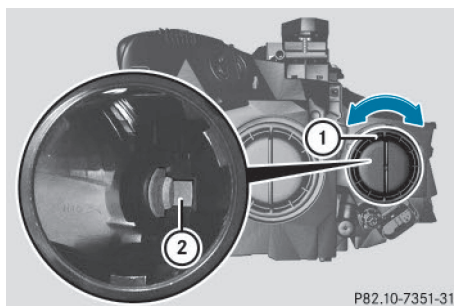

P82.10-7351-31

- ▶ Switch off the lights.
- ▶ Open the hood.
- ▶ Turn housing cover ① counter-clockwise and remove it.
- ▶ Turn bulb holder ② counter-clockwise and pull out.
- ▶ Insert the new bulb and engage it to the stop.
- ▶ Press on housing cover ① and turn it to the right.

Turn signals (halogen headlamps)

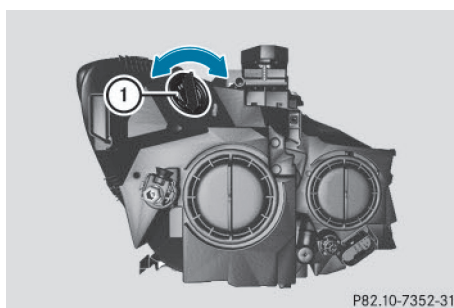

P82.10-7352-31

- ▶ Switch off the lights.
- ▶ Open the hood.
- ▶ Turn bulb holder ① counter-clockwise and pull out.

- ▶ Turn the bulb counter-clockwise and pull it out of bulb holder ①.
- ▶ Insert the new bulb into bulb holder ①.
- ▶ Insert bulb holder ① and turn it clockwise until it engages.

Replacing rear bulbs

Opening and closing the side trim panels

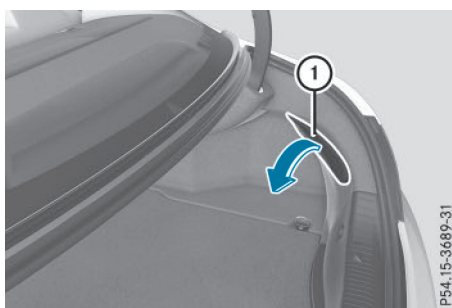

P84.15-3689-31

View of right-hand side trim panel

You must open the side trim panel in the trunk before you can replace the bulbs in the tail lamps.

- ▶ **To open:** release right or left side trim panel ① at the top and fold it down in the direction of the arrow.
- ▶ **To close:** insert side panel ①.

Tail lamps

- ▶ Switch off the lights.
- ▶ Open the trunk.
- ▶ Open the side trim panel (▷ page 105).

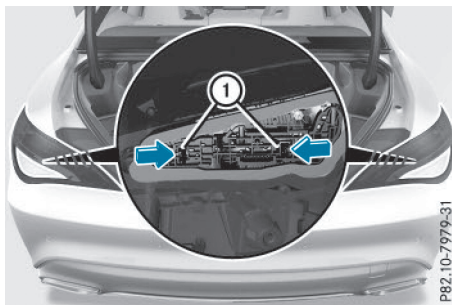

P82.10-7979-31

- ▶ Press retaining clips ① at the same time in the direction of the arrows.
- ▶ Carefully remove the bulb holder together with the connected plug and the bulbs.

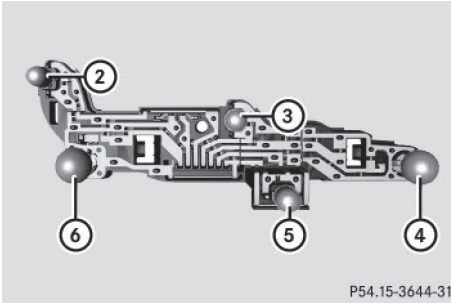

Bulb holder

- ② Brake lamp
- ③ Brake lamp
- ④ Rear fog lamp
- ⑤ Backup lamp
- ⑥ Turn signals

- ▶ **Brake lamp and backup lamp:** remove the corresponding bulb from the bulb holder.
- ▶ Insert the new bulb into the bulb holder.
- ▶ **Rear fog lamp and turn signal:** press the bulb gently into the bulb holder, turn it counter-clockwise and remove it from the bulb holder.
- ▶ Insert the new bulb into the bulb holder and turn it clockwise.
- ▶ Reinsert the bulb holder and engage on retaining clips ①.
- ▶ Close the side trim panel (▷ page 105).

Windshield wipers

Switching the windshield wipers on/off

❗ Do not operate the windshield wipers when the windshield is dry, as this could damage the wiper blades. Moreover, dust that has collected on the windshield can scratch the glass if wiping takes place when the windshield is dry.

If it is necessary to switch on the windshield wipers in dry weather conditions, always use washer fluid when operating the windshield wipers.

❗ If the windshield wipers leave smears on the windshield after the vehicle has been washed in an automatic car wash, wax or other residues may be the reason for this. Clean the windshield using washer fluid after washing the vehicle in an automatic car wash.

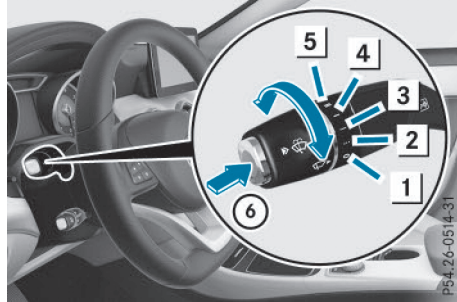

Combination switch

- ① 0 Windshield wiper off
- ② ... Intermittent wipe, low (rain sensor set to low sensitivity)
- ③ Intermittent wipe, high (rain sensor set to high sensitivity)
- ④ — Continuous wipe, slow
- ⑤ ≡ Continuous wipe, fast
- ⑥ [Washer fluid icon] Single wipe / [Washer fluid icon] Wipes the windshield using washer fluid

- ▶ Switch on the ignition.
- ▶ Turn the combination switch to the corresponding position.

❗ Vehicles with a rain sensor: if the windshield becomes dirty in dry weather conditions, the windshield wipers may be activated inadvertently. This could then damage the windshield wiper blades or scratch the windshield.

For this reason, you should always switch off the windshield wipers in dry weather.

Vehicles with a rain sensor: in the ... or position, the appropriate wiping frequency is automatically set according to the intensity of the rain. In the position, the rain sensor is more sensitive than in the ... position, causing the windshield wiper to wipe more frequently.

If the wiper blades are worn, the windshield will no longer be wiped properly. This could prevent you from observing the traffic conditions.

Replacing the wiper blades

Important safety notes

WARNING

If the windshield wipers begin to move while you are changing the wiper blades, you could be trapped by the wiper arm. There is a risk of injury.

Always switch off the windshield wipers and ignition before changing the wiper blades.

! To avoid damaging the wiper blades, make sure that you touch only the wiper arm of the wiper.

! Never open the hood if a windshield wiper arm has been folded away from the windshield.

Never fold a windshield wiper arm without a wiper blade back onto the windshield.

Hold the windshield wiper arm firmly when you change the wiper blade. If you release the windshield wiper arm without a wiper blade and it falls onto the windshield, the windshield may be damaged by the force of the impact.

Mercedes-Benz recommends that you have the wiper blades changed at a qualified specialist workshop.

Changing the windshield wiper blades

Removing the wiper blades

- ▶ **Vehicles without KEYLESS-GO or KEYLESS-GO start function:** remove the SmartKey from the ignition lock.
- ▶ **Vehicles with KEYLESS-GO or KEYLESS-GO start function:** switch off the engine.
- ▶ Fold the wiper arm away from the windshield.

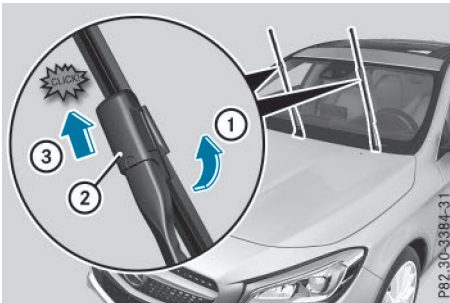

- ▶ Hold on to the wiper arm with one hand. With the other hand, turn wiper blade in direction of arrow ① away from the wiper arm as far as it will go.
- ▶ Slide catch ② in the direction of arrow ③ until it engages in the removal position with a noticeable click.



- ▶ Remove the wiper blade in the direction of arrow ④ away from the wiper arm.

Installing the wiper blades

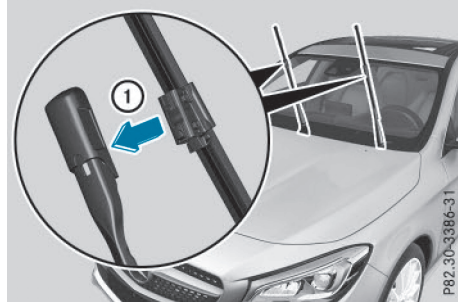

- ▶ Insert the new wiper blade into the wiper arm in the direction of arrow ①.

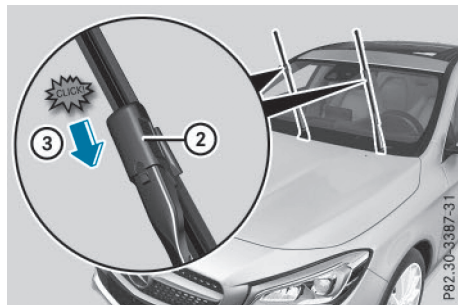

- ▶ Slide catch ② in the direction of arrow ③ until it engages in the locking position with a noticeable click.
- ▶ Make sure that the wiper blade is seated correctly.
- ▶ Fold the wiper arm back onto the windshield.

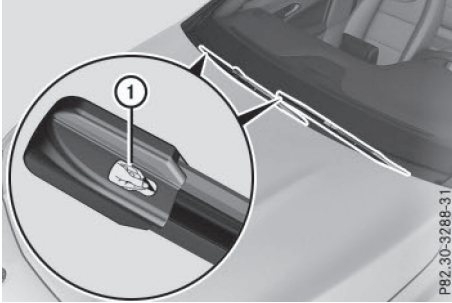

- ▶ Remove protective film ① of the service indicator on the tip of the wiper blade.

If the color of the service indicator changes from black to yellow, the wiper blades should be replaced.

- i** The duration of the color change varies depending on the usage conditions.

Problems with the windshield wipers

Problem	Possible causes/consequences and ▶ Solutions
The windshield wipers are jammed.	Leaves or snow, for example, may be obstructing the windshield wiper movement. The wiper motor has been deactivated. <ul style="list-style-type: none"> ▶ For safety reasons, you should remove the SmartKey from the ignition lock. ▶ Remove the cause of the obstruction. ▶ Switch the windshield wipers back on.
The windshield wipers fail completely.	The windshield wiper drive is malfunctioning. <ul style="list-style-type: none"> ▶ Select another wiper speed on the combination switch. ▶ Have the windshield wipers checked at a qualified specialist workshop.
The windshield washer fluid from the spray nozzles no longer hits the center of the windshield.	The spray nozzles are misaligned. <ul style="list-style-type: none"> ▶ Have the spray nozzles adjusted at a qualified specialist workshop.

Overview of climate control systems

General notes

Observe the settings recommended on the following pages. The windows could otherwise fog up.

To prevent the windows from fogging up:

- switch off climate control only briefly
- switch on air-recirculation mode only briefly
- switch on the cooling with air dehumidification function
- switch on the defrost windshield function briefly, if required

The air-conditioning system or dual-zone automatic climate control regulates the temperature and the humidity of the vehicle interior and filters undesirable substances from the air.

The air-conditioning system or dual-zone automatic climate control can only be operated when the engine is running. Optimum operation is only achieved with the side windows and panorama roof with power tilt/sliding panel closed. If you start the engine using your smartphone, the last selected climate control setting is reactivated (> page 122).

The residual heat function can only be activated or deactivated with the ignition switched off (> page 118).

Always keep the ventilation flaps behind the side trim panel in the cargo compartment clear (> page 105). Otherwise the vehicle will not be ventilated correctly.

- i** Ventilate the vehicle for a brief period during warm weather, e.g. using the convenience opening feature (> page 82). This will speed up the cooling process and the desired interior temperature will be reached more quickly.
- i** The integrated filter filters out most particles of dust and soot and completely filters out pollen. It also reduces gaseous pollutants and odors. A clogged filter reduces the amount of air supplied to the vehicle interior. For this reason, you should always observe the interval for replacing the filter, which is specified in the Maintenance Booklet. As it depends on environmental conditions, e.g. heavy air pollution, the interval may be shorter than stated in the Maintenance Booklet.
- i** It is possible that under certain circumstances the residual heat function may be activated automatically an hour after the SmartKey has been removed in order to dry the automatic climate control. The vehicle is then ventilated for 30 minutes.

Air-conditioning system control panel

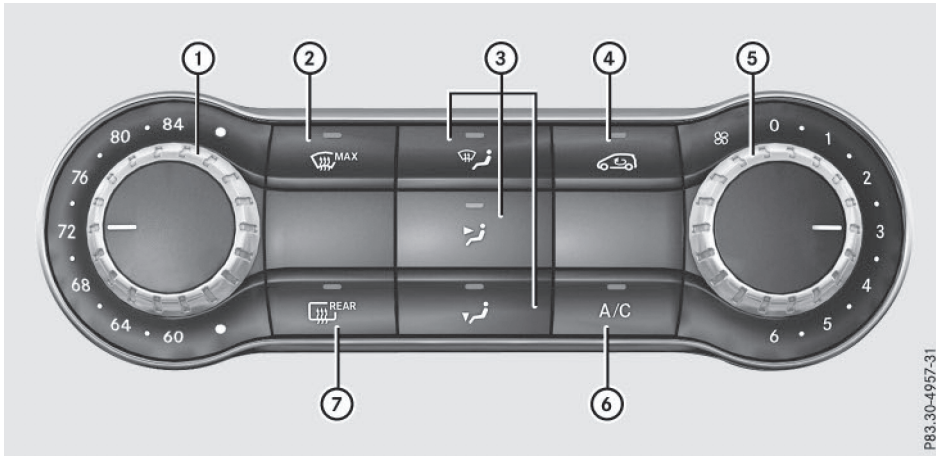

P83.30-4957-31

USA only

- ① Sets the temperature (▷ page 115)
- ② Defrosts the windshield (▷ page 116)
- ③ Sets the air distribution (▷ page 115)
- ④ Switches air-recirculation mode on/off (▷ page 118)
- ⑤ Sets the airflow (▷ page 116)
- ⑥ Switches cooling with air dehumidification on/off (▷ page 114)
- ⑦ Switches the rear window defroster on/off (▷ page 117)

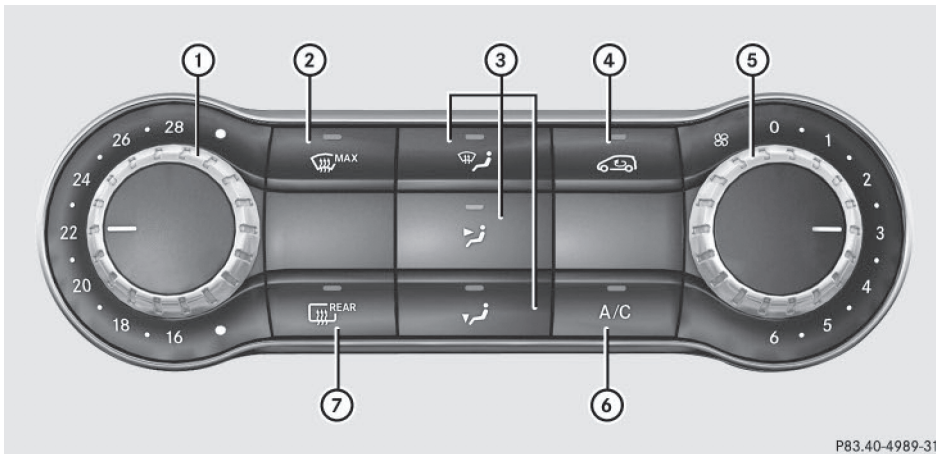

P83.40-4989-31

Canada only











- ① Sets the temperature (▷ page 115)
- ② Defrosts the windshield (▷ page 116)
- ③ Sets the air distribution (▷ page 115)
- ④ Switches air-recirculation mode on/off (▷ page 118)
- ⑤ Sets the airflow (▷ page 116)

- ⑥ Switches cooling with air dehumidification on/off (▷ page 114)
- ⑦ Switches the rear window defroster on/off (▷ page 117)

Notes on using the air-conditioning system

Air-conditioning system

Below, you can find a number of notes and recommendations to help you use the air-conditioning system optimally.

- Switch on the air-conditioning system by turning control knob ⑤ clockwise to the desired position (except position 0).
- Set the temperature to 72 °F (22 °C).
- **Recommendation for avoiding misted windows at low exterior temperatures or in rain:** switch on the  cooling with dehumidification function (▷ page 114).
Set air distribution to  and if possible switch off  and  (▷ page 115).
Deactivate air-recirculation mode  (▷ page 118).
Set airflow control ⑤ to a setting between 3 and 6 (▷ page 116).
- **Recommendation for rapid cooling or heating of the vehicle interior:** briefly set airflow control ⑤ to a setting between 3 and 6 (▷ page 116).
- **Recommendation for a constant vehicle interior temperature:** set airflow control ⑤ to a setting between 1 and 3 (▷ page 116).
- **Recommendation for air distribution in winter:** select the  and  settings (▷ page 115).
Recommendation for air distribution in summer: select the  or  and  settings (▷ page 115).
- Only use the "Windshield defrosting" function briefly until the windshield is clear again.

- Only use air-recirculation mode briefly, e.g. if there are unpleasant outside odors or when in a tunnel. The windows could otherwise fog up, since no fresh air is drawn into the vehicle in air-recirculation mode.
- If you change the settings of the climate control system, the climate status display appears for approximately three seconds at the bottom of the screen in the multimedia system display; see separate operating instructions. You will see the current settings of the various climate control functions.

DYNAMIC SELECT button (except Mercedes-AMG vehicles)

You can choose between various drive programs with the DYNAMIC SELECT button (▷ page 127).

If you have selected drive program E:

- when heating, the electrical heater booster is deactivated and in the warming-up phase heat output is reduced
- the rear window defroster running time is reduced

Depending on the configuration, climate settings may also be influenced in the drive program I.

If you have selected drive program C or S, climate settings are not influenced.

ECO start/stop function

During automatic engine switch-off, the climate control system only operates at a reduced capacity. If you require the full climate control output, you can switch off the ECO start/stop function by pressing the ECO button (▷ page 126).

Control panel for dual-zone automatic climate control

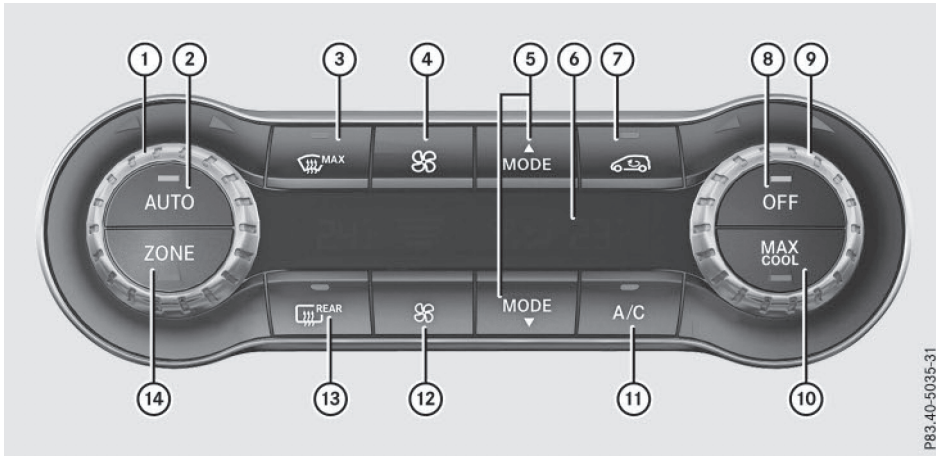

P83.40-5035-31

USA only

- ① Sets the temperature, left (▷ page 115)
- ② Sets climate control to automatic (▷ page 115)
- ③ Defrosts the windshield (▷ page 116)
- ④ Increases the airflow (▷ page 116)
- ⑤ Sets the air distribution (▷ page 115)
- ⑥ Display
- ⑦ Switches air-recirculation mode on/off (▷ page 118)
- ⑧ Activates/deactivates climate control (▷ page 114)
- ⑨ Sets the temperature, right (▷ page 115)
- ⑩ Activates or deactivates maximum cooling (▷ page 117)
- ⑪ Switches cooling with air dehumidification on/off (▷ page 114)
- ⑫ Reduces the airflow (▷ page 116)
- ⑬ Switches the rear window defroster on/off (▷ page 117)
- ⑭ Switches the ZONE function on/off (▷ page 116)

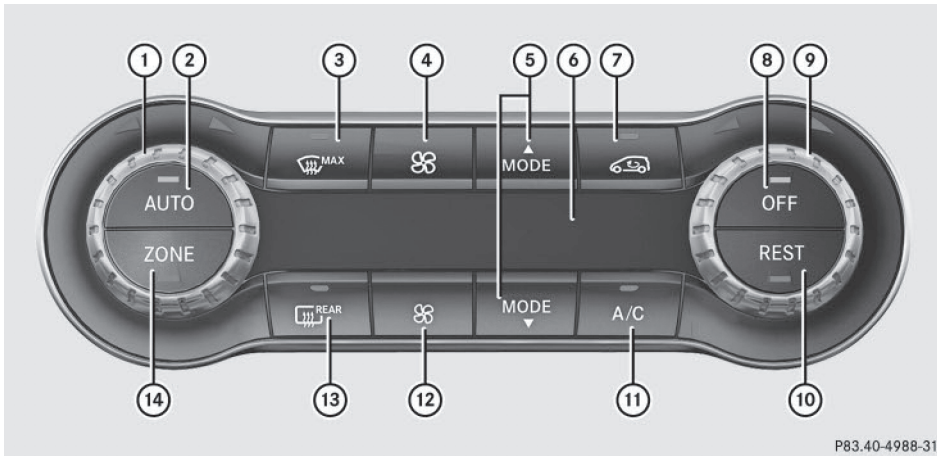

P83.40-4988-31

Canada only

- ① Sets the temperature, left (▷ page 115)
- ② Sets climate control to automatic (▷ page 115)
- ③ Defrosts the windshield (▷ page 116)
- ④ Increases the airflow (▷ page 116)
- ⑤ Sets the air distribution (▷ page 115)
- ⑥ Display
- ⑦ Switches air-recirculation mode on/off (▷ page 118)
- ⑧ Activates/deactivates climate control (▷ page 114)
- ⑨ Sets the temperature, right (▷ page 115)
- ⑩ Switches the residual heat on or off (▷ page 118)
- ⑪ Switches cooling with air dehumidification on/off (▷ page 114)
- ⑫ Reduces the airflow (▷ page 116)
- ⑬ Switches the rear window defroster on/off (▷ page 117)
- ⑭ Switches the ZONE function on/off (▷ page 116)

Optimum use of 3-zone automatic climate control

Climate control system

The following contains instructions and recommendations to enable you to get the most out of your dual-zone automatic climate control.

- Activate climate control using the **AUTO** and **A/C** buttons. The indicator lamps in the **AUTO** and **A/C** buttons light up.
- Set the temperature to 72 °F (22 °C).
- Only use the "Windshield defrosting" function briefly until the windshield is clear again.
- Only use air-recirculation mode briefly, e.g. if there are unpleasant outside odors or when in a tunnel. The windows could otherwise fog up, since no fresh air is drawn into the vehicle in air-recirculation mode.
- Use the ZONE function to adopt the temperature settings on the driver's side for the front-passenger side as well. The indicator lamp in the **ZONE** button goes out.
- Use the residual heat function if you want to heat or ventilate the vehicle interior when the ignition is switched off. The residual heat function can only be activated or deactivated with the ignition switched off.
- If you change the settings of the climate control system, the climate status display appears for approximately three seconds at the bottom of the screen in the multimedia system display; see separate operating

instructions. You will see the current settings of the various climate control functions.

DYNAMIC SELECT button (except Mercedes-AMG vehicles)

You can choose between various drive programs with the DYNAMIC SELECT button (▷ page 127).

If you have selected drive program **E**:

- when heating, the electrical heater booster is deactivated and in the warming-up phase heat output is reduced
- the rear window defroster running time is reduced

Depending on the configuration, climate settings may also be influenced in the drive program **I**.

If you have selected drive program **C** or **S**, climate settings are not influenced.

ECO start/stop function

During automatic engine switch-off, the climate control system only operates at a reduced capacity. If you require the full climate control output, you can switch off the ECO start/stop function by pressing the ECO button (▷ page 126).

Operating the climate control systems

Activating/deactivating climate control

General notes

When the climate control is switched off, the air supply and air circulation are also switched off. The windows could fog up. Therefore, switch off climate control only briefly

Air-conditioning system

- ▶ Turn the SmartKey to position **2** in the ignition lock (▷ page 121).
- ▶ **To switch on:** turn control **5** clockwise to the desired position (except position **0**) (▷ page 110).
- ▶ **To switch off:** turn control **5** counter-clockwise to position **0** (▷ page 110).

Dual-zone automatic climate control

- ▶ Turn the SmartKey to position **2** in the ignition lock (▷ page 121).

- ▶ **To activate:** press the **AUTO** button. The indicator lamp in the **AUTO** button lights up. Airflow and air distribution are set to automatic mode.

or

- ▶ Press the **OFF** button. The indicator lamp in the **OFF** button goes out. The previously selected settings are restored.
- ▶ **To deactivate:** press the **OFF** button. The indicator lamp in the **OFF** button lights up.

- ▶ **i** Dual-zone automatic climate control: switch on climate control primarily using the **AUTO** button.

Switching cooling with air dehumidification on/off

General notes

If you deactivate the "Cooling with air-dehumidification" function, the air inside the vehicle will not be cooled. The air inside the vehicle will also not be dehumidified. The windows can fog up more quickly. Therefore, only deactivate the "Cooling with air-dehumidification" function briefly.

The "Cooling with air dehumidification" function is only available when the engine is running. The air inside the vehicle is cooled and dehumidified according to the temperature selected.

Condensation may drip from the underside of the vehicle when it is in cooling mode. This is normal and not a sign that there is a malfunction.

Activating/deactivating

- ▶ Press the **A/C** button. The indicator lamp in the **A/C** button lights up or goes out. The indicator lamp in the button indicates that the respective function is activated. The "Cooling with air dehumidification" function has a delayed switch-off feature.

Problems with the "Cooling with air dehumidification" function

Problem	Possible causes/consequences and ► Solutions
The indicator lamp in the  button flashes three times or remains off. The "Cooling with air dehumidification" function cannot be switched on.	Cooling with air dehumidification has been deactivated due to a malfunction. ► Visit a qualified specialist workshop.

Setting climate control to automatic







General notes

The automatic climate control function is only available in conjunction with dual-zone automatic climate control.

In automatic mode, the set temperature is maintained automatically at a constant level. The system automatically regulates the temperature of the dispensed air, the airflow and the air distribution.

The "Cooling with air dehumidification" function is activated automatically in automatic mode.

Setting climate control to automatic

- Turn the SmartKey to position **2** in the ignition lock (► page 121).
 - Set the desired temperature.
 - **To activate:** press the  button. The indicator lamp in the  button lights up. Automatic air distribution and airflow are activated.
 - **To switch to manual mode:** press the  or  button.
- or
- Press the  or  button. The indicator lamp in the  button goes out. Automatic air distribution and airflow are deactivated.

Setting the temperature



Air-conditioning system

You can set the temperature for the entire vehicle. The set temperature is automatically maintained at a constant level.

- Turn the SmartKey to position **2** in the ignition lock (► page 121).
- **To increase or reduce:** turn control  counter-clockwise or clockwise (► page 110). Only change the temperature setting in small increments. Start at 72 °F (22 °C).

Dual-zone automatic climate control



Different temperatures can be set for the driver's and front-passenger sides. The set temperature is automatically maintained at a constant level.

- Turn the SmartKey to position **2** in the ignition lock (► page 121).
- **To increase or decrease:** turn control  or  counter-clockwise or clockwise (► page 112). Only change the temperature setting in small increments. Start at 72 °F (22 °C).

Setting the air distribution

Air-conditioning system

Air distribution settings

-  Directs air through the defroster vents
-  Directs air through the center and side air vents
-  Directs air through the footwell air vents

i You can also activate several air distribution settings simultaneously. To do this, press multiple air distribution buttons. The air is then directed through various vents.







i Regardless of the air distribution setting, airflow is always directed through the side air vents. The side air vents can only be closed if the adjusters are turned clockwise until they engage.

Setting the air distribution

- ▶ Turn the SmartKey to position **2** in the ignition lock (▷ page 121).
- ▶ Press one or more of the  buttons. The corresponding indicator lamp lights up briefly.



Dual-zone automatic climate control

Air distribution settings

-  Directs air through the defroster vents
-  Directs air through the center and side air vents
-  Directs air through the footwell air vents
-  Directs air through the center, side and footwell vents
-  Directs air through the defroster, center and side air vents
-  Directs air through the defroster and footwell vents
-  Directs air through the defroster, center, side and footwell vents

i Regardless of the air distribution setting, airflow is always directed through the side air vents. The side air vents can only be closed if the adjusters are turned clockwise until they engage.

Setting the air distribution



- ▶ Turn the SmartKey to position **2** in the ignition lock (▷ page 121).
- ▶ Press the  or  button repeatedly until the desired symbol appears in the display.

Setting the airflow

Air-conditioning system





- ▶ Turn the SmartKey to position **2** in the ignition lock (▷ page 121).
- ▶ **To increase or reduce:** turn control  counter-clockwise or clockwise (▷ page 110).

Dual-zone automatic climate control

- ▶ Turn the SmartKey to position **2** in the ignition lock (▷ page 121).
- ▶ **To increase or reduce:** press the  or  button.

Switching the ZONE function on/off

This function is only available with dual-zone automatic climate control.

- ▶ **To activate:** press the  button. The indicator lamp in the  button lights up. The temperature setting for the driver's side is not adopted for the front-passenger side.
- ▶ **To deactivate:** press the  button. The indicator lamp in the  button goes out. The temperature setting for the driver's side is adopted for the front-passenger side.



Defrosting the windshield

General notes

You can use this function to defrost the windshield or to clear a fogged up windshield and side windows.

i You should only select the "Windshield defrosting" function until the windshield is clear again.

Switching the "Windshield defrosting" function on or off



- ▶ Turn the SmartKey to position **2** in the ignition lock (▷ page 121).
- ▶ **To activate:** press the  button. The indicator lamp in the  button lights up.



The climate control system switches to the following functions:

- high airflow
- high temperature
- air distribution to the windshield and front side windows
- air-recirculation mode off

i The "Windshield defrosting" function automatically sets the blower output to the optimum defrosting effect. As a result, the airflow may increase or decrease automatically after the  button is pressed.

i You can adjust the blower output manually while the "Windshield defrosting" function is in operation:

- Air-conditioning system: turn airflow control  counter-clockwise or clockwise (▷ page 110).
- Dual-zone automatic climate control: press the  or  button.



▶ **To deactivate:** press the  button. The indicator lamp in the  button goes out. The previously selected settings are restored. Air-recirculation mode remains deactivated.

or

▶ Dual-zone automatic climate control: press the **AUTO** button. The indicator lamp in the  button goes out. Airflow and air distribution are set to automatic mode.

or

▶ Air-conditioning system: turn temperature control  counter-clockwise or clockwise (▷ page 110).

Dual-zone automatic climate control: turn temperature control  or  counter-clockwise or clockwise (▷ page 112).

MAX COOL maximum cooling

The MAX COOL function is only available in vehicles for the USA.

MAX COOL is only operational when the engine is running.

▶ **To activate:** press the  button.

The indicator lamp in the button lights up.

▶ **To deactivate:** press the  button.

The indicator lamp goes out. The previously selected settings are restored.

When you activate MAX COOL, climate control switches to the following functions:

- maximum cooling
- maximum airflow
- air-recirculation mode on

Defrosting the windows

Windows fogged up on the inside

Air-conditioning system

▶ Activate the  "Cooling with air dehumidification" function.

▶ If the windows continue to fog up, activate the  "Windshield defrosting" function.

i You should only select this setting until the windshield is clear again.

Dual-zone automatic climate control

▶ Activate the  "Cooling with air dehumidification" function.

▶ Activate automatic mode **AUTO**.

▶ If the windows continue to fog up, activate the  "Windshield defrosting" function.

i You should only select this setting until the windshield is clear again.

Windows fogged up on the outside

▶ Activate the windshield wipers.

▶ Set the air distribution to  or .

i You should only select this setting until the windshield is clear again.



Rear window defroster

General notes

The rear window defroster has a high current draw. You should therefore switch it off as soon as the rear window is clear. Otherwise, the rear window defroster switches off automatically after several minutes.

If the battery voltage is too low, the rear window defroster may switch off.

Activating/deactivating

- ▶ Turn the SmartKey to position **2** in the ignition lock (▷ page 121).
- ▶ Press the  button.
The indicator lamp in the  button lights up or goes out.

Problems with the rear window defroster

Problem	Possible causes/consequences and ▶ Solutions
The rear window defroster has deactivated prematurely or cannot be activated.	The battery has not been sufficiently charged. ▶ Switch off any consumers that are not required, e.g. reading lamps, interior lighting or the seat heating. When the battery is sufficiently charged, the rear window defroster can be activated again.

Switching air-recirculation mode on/off



General notes

You can deactivate the flow of fresh air if unpleasant odors are entering the vehicle from outside. The air already inside the vehicle will then be recirculated.

If you switch on air-recirculation mode, the windows can fog up more quickly, in particular at low temperatures. Only use air-recirculation mode briefly to prevent the windows from fogging up.

The operation of air-recirculation mode is the same for all control panels.



Activating/deactivating

- ▶ Turn the SmartKey to position **2** in the ignition lock (▷ page 121).
- ▶ **To activate:** press the  button.
The indicator lamp in the  button lights up.

Air-recirculation mode switches on automatically:

- at high outside temperatures
- at high levels of pollution

When air-recirculation mode is activated automatically, the indicator lamp in the  button is not lit. Outside air is added after about 30 minutes.

- ▶ **To deactivate:** press the  button.
The indicator lamp in the  button goes out.

i Air-recirculation mode deactivates automatically:

- after approximately five minutes at outside temperatures below approximately 45 °F (7 °C)
- after approximately five minutes if the "Cooling with air dehumidification" function is deactivated
- after approximately 30 minutes at outside temperatures above approximately 45 °F (7 °C) if the cooling with air dehumidification function is activated

Switching the residual heat on or off

General notes

The residual heat function is only available in vehicles for Canada with dual-zone automatic climate control.

It is possible to make use of the residual heat of the engine to continue heating the vehicle for approximately 30 minutes after the engine has been switched off. The heating time depends on the set interior temperature.

- i** The blower will run at a low speed regardless of the airflow setting.

- i** If you activate the residual heat function at high temperatures, only the ventilation will be activated. The blower runs at medium speed.
- i** You cannot use the ventilation to cool the vehicle interior to a temperature lower than the outside temperature.

Activating/deactivating

- ▶ Turn the SmartKey to position **0** in the ignition lock or remove it (▷ page 121).
- ▶ Press the **REST** button.
The indicator lamp in the **REST** button lights up or goes out.
The indicator lamp in the button indicates that the respective function is activated.
- i** Residual heat is deactivated automatically:
 - after approximately 30 minutes
 - when the ignition is switched on
 - if the battery voltage drops

Air vents

Important safety notes

WARNING

Very hot or very cold air can flow from the air vents. This could result in burns or frostbite in the immediate vicinity of the air vents. There is a risk of injury.

Make sure that all vehicle occupants always maintain a sufficient distance to the air outlets. If necessary, redirect the airflow to another area of the vehicle interior.

In order to ensure the direct flow of fresh air through the air vents into the vehicle interior, please observe the following notes:

- keep the air inlet between the windshield and the hood free of blockages, such as ice, snow or leaves.
- never cover the air vents or air intake grilles in the vehicle interior.
- i** For optimal climate control in the vehicle, open the air vents completely and set the adjusters to the central position.

Setting the air vents

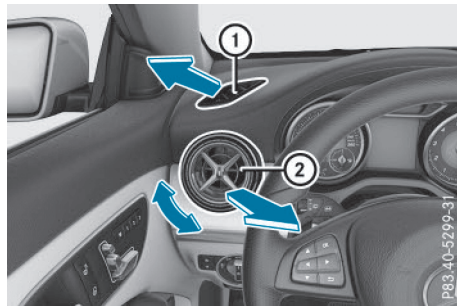

- ① Side window defroster vent
- ② Side air vent

- ▶ **To open a side air vent:** turn the adjuster in side air vent ② to the left.
- ▶ **To close a side air vent:** turn the adjuster in side air vent ② clockwise as far as it will go.

- i** The center and rear air vents are adjusted in the same way.

Notes on breaking-in a new vehicle

Important safety notes

The sensor system of some driving and driving safety systems adjusts automatically while a certain distance is being driven after the vehicle has been delivered or after repairs. Full system effectiveness is not reached until the end of this teach-in procedure.

New and replaced brake pads and discs only reach their optimum braking effect after several hundred kilometers of driving. Compensate for this by applying greater force to the brake pedal.

The first 1000 miles (1500 km)

The more you look after the engine when it is new, the more satisfied you will be with its performance in the future.

- You should therefore drive at varying vehicle and engine speeds for the first 1000 miles (1500 km).
- Avoid heavy loads, e.g. driving at full throttle, during this period.
- Change gear in good time, before the tachometer needle is $\frac{2}{3}$ of the way to the red area of the tachometer.
- Do not manually shift to a lower gear to brake the vehicle.
- Try to avoid depressing the accelerator pedal beyond the point of resistance (kickdown).
- Ideally, for the first 1000 miles (1500 km), drive in program **E**.

Additional breaking-in notes for Mercedes-AMG vehicles:

- Do not drive faster than 85 mph (140 km/h) for the first 1,000 miles (1,500 km).
- Only allow the engine to reach a maximum engine speed of 4,500 rpm briefly.
- Change gear in good time.

After 1,000 miles (1,500 km), you can increase the engine speed gradually and bring the vehicle to full speed.

You should also observe these notes on breaking-in if the engine or parts of the drive train on your vehicle have been replaced.

Always observe the maximum permissible speed.

Driving

Important safety notes

WARNING

Objects in the driver's footwell can restrict the pedal travel or obstruct a depressed pedal.

The operating and road safety of the vehicle is jeopardized. There is a risk of an accident.

Make sure that all objects in the vehicle are stowed correctly, and that they cannot enter the driver's footwell. Install the floor mats securely and as specified in order to ensure sufficient clearance for the pedals. Do not use loose floor mats and do not place floor mats on top of one another.

WARNING

Unsuitable footwear can hinder correct usage of the pedals, e.g.:

- shoes with thick soles
- shoes with high heels
- slippers

There is a risk of an accident.

Wear suitable footwear to ensure correct usage of the pedals.

WARNING

If you switch off the ignition while driving, safety-relevant functions are only available with limitations, or not at all. This could affect, for example, the power steering and the brake boosting effect. You will require considerably more effort to steer and brake. There is a risk of an accident.

Do not switch off the ignition while driving.

WARNING

If the parking brake has not been fully released when driving, the parking brake can:

- overheat and cause a fire
- lose its hold function.

There is a risk of fire and an accident. Release the parking brake fully before driving off.

! Do not warm up the engine with the vehicle stationary. Drive off immediately. Avoid high engine speeds and driving at full throttle until the engine has reached its operating temperature.

Only shift the automatic transmission to the desired drive position when the vehicle is stationary.

Where possible, avoid spinning the drive wheels when pulling away on slippery roads. You could otherwise damage the drive train.

! **Mercedes-AMG vehicles:** avoid full-load operation and engine speeds greater than 5000 rpm when the engine is cold. This helps to protect the engine and avoids uncomfortable driving.

SmartKey positions

SmartKey



- 0** To remove the SmartKey (shift the transmission to position **P**)
 - 1** Power supply for some consumers, such as the windshield wipers
 - 2** Ignition (power supply for all consumers) and drive position
 - 3** To start the engine
- i** The SmartKey can be turned in the ignition lock even if it is not the correct SmartKey for the vehicle. The ignition is not switched on. The engine cannot be started.

Start/Stop button

General notes

Vehicles with KEYLESS-GO are equipped with SmartKeys featuring the integrated KEYLESS-GO function and a detachable Start/Stop button.

A check which periodically establishes a radio connection between the vehicle and the SmartKey determines whether a valid SmartKey is in the vehicle. This occurs, for example, when starting the engine.

When you insert the Start/Stop button into the ignition lock, the system needs approximately two seconds recognition time. You can then use the Start/Stop button.

Pressing the Start/Stop button several times in succession corresponds to the different SmartKey positions in the ignition lock. This is only the case if you are not depressing the brake pedal. If you depress the brake pedal and press the Start/Stop button, the engine starts immediately.

To start the vehicle without actively using the SmartKey:

- the Start/Stop button must be inserted in the ignition lock.
- the SmartKey must be in the vehicle.
- the vehicle must not be locked with the SmartKey or KEYLESS-GO (▷ page 70)

Do not keep the KEYLESS-GO key:

- with electronic devices, e.g. a mobile phone or another SmartKey.
- with metallic objects, e.g. coins or metal foil.
- inside metallic objects, e.g. a metal case

This can affect the functionality of KEYLESS-GO.

If you lock the vehicle with the SmartKey remote control or with KEYLESS-GO, after a short time:

- you will not be able to switch on the ignition with the Start/Stop button.
- you will no longer be able to start the engine with the Start/Stop button until the vehicle is unlocked again

If you lock the vehicle centrally using the button on the front door (▷ page 75), you can continue to start the engine with the Start/Stop button.

The engine can be switched off while the vehicle is in motion by pressing and holding the Start/Stop button for three seconds. This function

operates independently of the ECO start/stop automatic engine switch-off function.

Key positions with the Start/Stop button

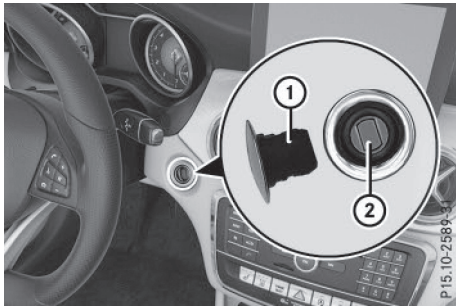

- ① Start/Stop button
- ② Ignition lock

As soon as the ignition is switched on, all the indicator lamps in the instrument cluster light up.

For further information on situations in which an indicator lamp either fails to go out after the engine is started or lights up while driving, please refer to "Warning and indicator lamps in the instrument cluster" (▷ page 217).

If Start/Stop button ① has not yet been pressed, this corresponds to the SmartKey being removed from the ignition.

- ▶ **To switch on the power supply:** press Start/Stop button ① once.
The power supply is switched on. You can now activate the windshield wipers, for example.

The power supply is switched off again if:

- the driver's door is opened and
- you press Start/Stop button ① twice when in this position

- ▶ **To switch on the ignition:** press Start/Stop button ① twice.
The ignition is switched on.
If you press Start/Stop button ① once when in this position, the ignition is switched off again.

Removing the Start/Stop button

You can remove the Start/Stop button from the ignition lock and start the vehicle as normal using the SmartKey.

You can only switch between Start/Stop button mode and SmartKey operation when the vehicle is stationary.

You must also engage park position **P**.

- ▶ Remove Start/Stop button ① from ignition lock ②.

You do not have to remove the Start/Stop button from the ignition lock when you leave the vehicle. You should, however, always take the SmartKey with you when leaving the vehicle. As long as the SmartKey is in the vehicle:

- the vehicle can be started using the Start/Stop button
- the electrically powered equipment can be operated

Starting the engine

Important safety notes

⚠ WARNING

If children are left unsupervised in the vehicle, they could:

- open the doors, thus endangering other people or road users.
- get out and disrupt traffic.
- operate the vehicle's equipment.

Additionally, children could set the vehicle in motion if, for example, they:

- release the parking brake.
- shifting the automatic transmission out of park position **P**
- Start the engine.

There is a risk of an accident and injury.

When leaving the vehicle, always take the SmartKey with you and lock the vehicle. Never leave children or animals unattended in the vehicle. Always keep the SmartKey out of reach of children.

⚠ WARNING

Combustion engines emit poisonous exhaust gases such as carbon monoxide. Inhaling these exhaust gases leads to poisoning. There is a risk of fatal injury. Therefore never leave the engine running in enclosed spaces without sufficient ventilation.

⚠ WARNING

Flammable materials introduced through environmental influence or by animals can ignite if in contact with the exhaust system or parts of the engine that heat up. There is a risk of fire.

Carry out regular checks to make sure that there are no flammable foreign materials in the engine compartment or in the exhaust system.

General notes

During a cold start, the engine runs at higher speeds to enable the catalytic converter to reach its operating temperature. The sound of the engine may change during this time.

Automatic transmission

- ▶ Shift the transmission to position **P** (▷ page 129).
The transmission position display in the multifunction display shows **P** (▷ page 129).

- i** You can start the engine in transmission position **P** and **N**.

Starting procedure with the SmartKey

To start the engine using the SmartKey instead of the Start/Stop button, pull the Start/Stop button out of the ignition lock.

- ▶ Turn the SmartKey to position **3** in the ignition lock and release it as soon as the engine is running (▷ page 121).

Starting procedure with the Start/Stop button

The Start/Stop button can be used to start the vehicle manually without inserting the SmartKey into the ignition lock. The Start/Stop button must be inserted in the ignition lock and the SmartKey must be in the vehicle. This mode for starting the engine operates independently of the ECO start/stop automatic engine start function.

You can start the engine if a valid SmartKey is in the vehicle. Switch off the engine and always take the SmartKey with you when leaving the

vehicle, even if you only leave it for a short time. Pay attention to the important safety notes.

- ▶ Depress the brake pedal and keep it depressed.
- ▶ Press the Start/Stop button once (▷ page 121).
The engine starts.

Starting procedure via smartphone

Observe the important safety notes on starting the engine (▷ page 122).

You can also start your engine via your smartphone from outside the vehicle. In this case, the previously selected climate control setting is activated. In this way you can cool or heat the interior of the vehicle before starting the journey.

Only start the engine via your smartphone if it is safe to start and run the engine where your vehicle is parked.

Observe the legal stipulations in the area where your vehicle is parked. Engine start via smartphone may be limited to certain countries or regions.

You can execute a maximum of two consecutive starting attempts via your smartphone. If you insert the SmartKey into the ignition lock, you can carry out two more starting attempts.

Once you have started the engine, you can switch the engine off via your smartphone at any time.

You can only start the engine via your smartphone if:

- the SmartKey is in the ignition lock
- park position **P** is selected
- the accelerator pedal is not depressed
- the anti-theft alarm system is not activated
- the panic alarm is not activated
- the hazard warning lamps are switched off
- the hood is closed.
- the doors are closed and locked
- the windows and sliding sunroof are closed

Also make sure that:

- the fuel tank is sufficiently filled
- the starter battery is sufficiently charged

⚠ WARNING

Limbs could be crushed or trapped if the engine is started unintentionally during ser-

vice or maintenance work. There is a risk of injury.

Always secure the engine against unintentional starting before carrying out maintenance or repair work.

Make sure that the engine cannot be started via your smartphone before carrying out maintenance or repairs. You can prevent an engine start via your smartphone, for example, if you:

- switch on the hazard warning lamps
- do not lock the doors
- open the hood

Pulling away

General notes

WARNING

If the engine speed is above the idling speed and you engage transmission position **D** or **R**, the vehicle could pull away suddenly. There is a risk of an accident.

When engaging transmission position **D** or **R**, always firmly depress the brake pedal and do not simultaneously accelerate.

Depress the accelerator carefully when pulling away.

The vehicle locks centrally once you have pulled away. The locking knobs in the doors drop down. You can open the doors from the inside at any time.

You can also deactivate the automatic locking feature (▷ page 184).

It is only possible to shift the transmission from position **P** to the desired position if you depress the brake pedal. Only then can the parking lock be deactivated.

All vehicles (except Mercedes-AMG vehicles): if you do not depress the brake pedal, the DIRECT SELECT lever can still be moved but the parking lock remains engaged.

Mercedes-AMG vehicles: if you do not depress the brake pedal, the selector lever can still be moved but the parking lock remains engaged.

At transmission fluid temperatures below -4 °F (-20 °C), you can only shift out of park position **P**

into another transmission position when the engine is running.

- i** Upshifts take place at higher engine speeds after a cold start. This helps the catalytic converter to reach its operating temperature more quickly.

Information on the automatic release of the electric parking brake (▷ page 142).

Hill start assist

Hill start assist helps you when pulling away forwards or in reverse on an uphill gradient. It holds the vehicle for a short time after you have removed your foot from the brake pedal. This gives you enough time to move your foot from the brake pedal to the accelerator pedal and to depress it before the vehicle begins to roll.

WARNING

After a short time, hill start assist will no longer brake your vehicle and it could roll away. There is a risk of an accident and injury.

Therefore, quickly move your foot from the brake pedal to the accelerator pedal. Never leave the vehicle when it is held by hill start assist.

Hill start assist is not active if:

- you are pulling away on a level road or on a downhill gradient.
- the transmission is in position **N**.
- the electric parking brake is applied.
- ESP® is malfunctioning.

Further information on holding the vehicle stationary on uphill gradients (▷ page 133).

ECO start/stop function

Introduction

The ECO start/stop function switches the engine off automatically if the vehicle is stopped under certain conditions.

The engine starts automatically when the driver wants to pull away again. The ECO start/stop function thereby helps you to reduce the fuel consumption and emissions of your vehicle.

Important safety notes

WARNING

If the engine is switched off automatically and you exit the vehicle, the engine is restarted automatically. The vehicle may begin moving. There is a risk of accident and injury.

If you wish to exit the vehicle, always turn off the ignition and secure the vehicle against rolling away.

General notes

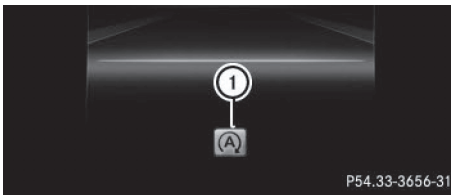

① ECO start/stop display

The ECO start/stop function is activated whenever you start the engine using the SmartKey or the Start/Stop button.

If the engine has been switched off automatically by the ECO start/stop function, the  ECO symbol is shown in the multifunction display.

Mercedes-AMG vehicles: the ECO start/stop function is only available in drive program **C**.

Automatic engine switch-off

If the vehicle is braked to a standstill in **D** or **N**, the ECO start/stop function switches off the engine automatically.

The ECO start/stop function is operational when:

- the indicator lamp in the ECO button is lit green.
- the outside temperature is within the range that is suitable for the system.
- the engine is at normal operating temperature.
- the set temperature for the vehicle interior has been reached.
- the battery is sufficiently charged.
- the system detects that the windshield is not fogged up when the air-conditioning system is switched on.

- the hood is closed.
- the driver's door is closed and the driver's seat belt is fastened.

All of the vehicle's systems remain active when the engine is stopped automatically.

The HOLD function can also be activated if the engine has been switched off automatically. It is then not necessary to continue applying the brakes during the automatic stop phase. When you depress the accelerator pedal, the engine starts automatically and the braking effect of the HOLD function is deactivated.

Automatic engine switch-off can take place a maximum of four times in a row (initial stop, then three subsequent stops).

Automatic engine start

The engine starts automatically if:

- you switch off the ECO start/stop function by pressing the ECO button
 - in transmission position **D** or **N** the brake pedal is released and the HOLD function is not active
 - you depress the accelerator pedal
 - you engage reverse gear **R**
 - you move the transmission out of position **P**
 - you unfasten your seat belt or open the driver's door
 - the vehicle starts to roll
 - the brake system requires this
 - the temperature in the vehicle interior deviates from the set range
 - the system detects moisture on the windshield when the air-conditioning system is switched on
 - the battery's condition of charge is too low
- Shifting the transmission to position **P** does not start the engine.

Deactivating or activating the ECO start/stop function



- ▶ **To deactivate:** press ECO button ①. Indicator lamp ② goes out.
- ▶ **To activate:** press ECO button ①. Indicator lamp ② lights up.

If indicator lamp ② is off, the ECO start/stop function has been deactivated manually or as the result of a malfunction. The engine will then not be switched off automatically when the vehicle stops.

AMG Performance exhaust system (Mercedes-AMG vehicles)

You can choose between different AMG Performance exhaust system volumes using the position of the exhaust flap.

Each time you start the engine with the Smart-Key or the Start/Stop button, the quietest setting is activated.



Setting the volume:

- ▶ Press button ①. If you select the loudest setting, indicator lamp ② lights up.

Problems with the engine

Problem	Possible causes/consequences and ► Solutions
The engine does not start.	<p>The HOLD function or Distance Pilot DISTRONIC is activated.</p> <ul style="list-style-type: none"> ▶ Deactivate the HOLD function (> page 156) or Distance Pilot DISTRONIC (> page 154). ▶ Try to start the engine again.
The engine does not start. The starter motor can be heard.	<ul style="list-style-type: none"> • There is a malfunction in the engine electronics. • There is a malfunction in the fuel supply. <p>Before attempting to start the engine again:</p> <ul style="list-style-type: none"> ▶ Turn the SmartKey back to position 0 in the ignition lock. <p>or</p> <ul style="list-style-type: none"> ▶ Press the Start/Stop button repeatedly until all indicator lamps in the instrument cluster go out. ▶ Try to start the engine again (> page 122). Avoid excessively long and frequent attempts to start the engine as these will drain the battery. <p>If the engine does not start after several attempts:</p> <ul style="list-style-type: none"> ▶ Consult a qualified specialist workshop.

Problem	Possible causes/consequences and ► Solutions
The engine does not start. You cannot hear the starter motor.	The on-board voltage is too low because the battery is too weak or discharged. ► Jump-start the vehicle (▷ page 273). If the engine does not start despite attempts to jump-start it: ► Consult a qualified specialist workshop.
	The starter motor was exposed to a thermal load that was too high. ► Allow the starter motor to cool down for approximately two minutes. ► Try to start the engine again. If the engine still does not start: ► Consult a qualified specialist workshop.
The engine is not running smoothly and is misfiring.	There is a malfunction in the engine electronics or in a mechanical component of the engine management system. ► Only depress the accelerator pedal slightly. Otherwise, non-combusted fuel may get into the catalytic converter and damage it. ► Have the cause rectified immediately at a qualified specialist workshop.
The coolant temperature gauge shows a value above 248 °F (120 °C). The coolant warning lamp may also be on and a warning tone may sound.	The coolant level is too low. The coolant is too hot and the engine is no longer being cooled sufficiently. ► Stop as soon as possible and allow the engine and the coolant to cool down. ► Check the coolant level (▷ page 257). Observe the warning notes as you do so and add coolant if necessary.

DYNAMIC SELECT button (all vehicles except Mercedes-AMG vehicles)

Use the DYNAMIC SELECT button to change the drive program. Depending on the drive program selected the following vehicle characteristics will change:

- the drive (engine and transmission management)
- the suspension (vehicles with damping system or AMG adaptive sport suspension system)
- the steering.
- the availability of the ECO start/stop function
- the climate control

Each time you start the engine with the Smart-Key or the Start/Stop button, drive program **C** is activated. For further information about starting the engine, see (▷ page 122).



- Press DYNAMIC SELECT button ① as many times as necessary until the desired drive program is selected. The selected drive program appears in the multifunction display. After five seconds the display goes out and the status icon of the selected drive program appears.

In addition, the current drive program settings are displayed briefly in the multimedia system display.

- i** In a few countries, the ECO start/stop function is deactivated at the factory due to the available fuel grade. In this case, the ECO start/stop function is not available in any drive program, regardless of the display in the multimedia system display.

Available drive programs:

C Comfort	Comfortable and economical driving characteristics
S Sport	Sporty driving characteristics
I Individual	Individual settings
E Economy	Particularly economical driving characteristics

Additional information for drive programs (▷ page 133).

You can also change gear yourself using the steering wheel paddle shifters. For further information on the manual drive program (▷ page 135).

DYNAMIC SELECT controller (Mercedes-AMG vehicles)

Use the DYNAMIC SELECT controller to change the drive program. Depending on the drive program selected the following vehicle characteristics will change:

- the drive
- the transmission management
- ESP®
- the suspension (vehicles with AMG adaptive sport suspension system)
- the availability of the ECO start/stop function
- the availability of gliding mode

Each time you start the engine with the Smart-Key or the Start/Stop button, drive program **C** is activated. For further information about starting the engine, see (▷ page 122).



- Turn DYNAMIC SELECT controller ① as many times as necessary until the desired drive program is selected.

The selected drive program appears in the multifunction display. After five seconds the display goes out and the status icon of the selected drive program appears.

The drive program indicator on DYNAMIC SELECT controller ① lights up in red.

Available drive programs:

I Individual	Individual settings
C Comfort	Comfort-oriented, optimum-economy engine and transmission settings
S Sport	Sporty engine and transmission settings
S+ Sport Plus	Particularly sporty transmission settings
Race	Maximum sportiness and engine and transmission settings suitable for the racetrack

Additional information for drive programs (▷ page 133).

You can also change gear yourself using the steering wheel paddle shifters. For further information on the manual drive program (▷ page 135).

Automatic transmission

Important safety notes

WARNING

If the engine speed is above the idling speed and you engage transmission position **D** or **R**, the vehicle could pull away suddenly. There is a risk of an accident.

When engaging transmission position **D** or **R**, always firmly depress the brake pedal and do not simultaneously accelerate.

WARNING

The automatic transmission switches to neutral position **N** when you switch off the engine. The vehicle may roll away. There is a risk of an accident.

After switching off the engine, always switch to parking position **P**. Prevent the parked vehicle from rolling away by applying the parking brake.

DIRECT SELECT lever

Overview of transmission positions

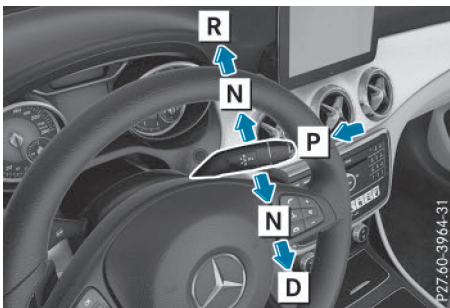

- P** Park position with parking lock
- R** Reverse gear
- N** Neutral
- D** Drive

All vehicles (except Mercedes-AMG vehicles): the DIRECT SELECT lever is on the right of the steering column.

For information on the selector lever in Mercedes-AMG vehicles (> page 131).

The DIRECT SELECT lever always returns to its original position. The current transmission position **P**, **R**, **N** or **D** appears in the transmission position display in the multifunction display (> page 129).

Transmission position and drive program display

The current transmission position and drive program appear in the multifunction display.



- ① Transmission position
- ② Gear
- ③ Drive program display

The arrows in the transmission position display show how and into which transmission positions you can shift using the DIRECT SELECT lever.

If the transmission position display in the multifunction display is not working, you should pull away carefully to check whether the desired transmission position is engaged. Ideally, you should select transmission position **D** and drive program **E** or **S**.

Engaging park position P

! If the engine speed is too high or the vehicle is moving, do not shift the automatic transmission directly from **D** to **R**, from **R** to **D** or directly to **P**. The automatic transmission could otherwise be damaged.

- ▶ Push the DIRECT SELECT lever in the direction of arrow **P**.

Transmission position display **P** is shown in the multifunction display.

When you have engaged park position **P**, make sure that the transmission position display shows **P** in the multifunction display.

You can only engage park position **P** when the vehicle is stationary.

Depressing the brake and pushing the DIRECT SELECT lever up or down disengages the parking lock. The transmission is in **N** neutral.

At transmission fluid temperatures below -4°F (-20°C), you can only shift out of park position **P** into another transmission position when the engine is running.

In order to shift from park position **P** directly into **R** or **D**:

- depress the brake pedal and
- push the DIRECT SELECT lever up or down past the first point of resistance

Engaging park position **P** automatically

Park position **P** is automatically engaged if:

- you switch off the engine using the SmartKey and remove the SmartKey
- you switch off the engine using the SmartKey or using the Start/Stop button and open the driver's door or front-passenger door
- you open the driver's door when the vehicle is stationary or when driving at a very low speed and the transmission is in position **D** or **R**

Under certain conditions, the automatic transmission shifts automatically to transmission position **P** if the HOLD function or Distance Pilot DISTRONIC is activated. Observe the information on the HOLD function (▷ page 156) and on Distance Pilot DISTRONIC (▷ page 153).

Engaging reverse gear **R**

! Only shift the automatic transmission to **R** when the vehicle is stationary.

- ▶ Depress the brake and keep it pressed.
- ▶ Push the DIRECT SELECT lever up past the first point of resistance.

The ECO start/stop function is not available when reverse gear is engaged. Further information on the ECO start/stop function (▷ page 125).

Shifting to neutral **N**

WARNING

If children are left unsupervised in the vehicle, they could:

- open the doors, thus endangering other people or road users.
- get out and disrupt traffic.
- operate the vehicle's equipment.

Additionally, children could set the vehicle in motion if, for example, they:

- release the parking brake.
- shifting the automatic transmission out of park position **P**
- Start the engine.

There is a risk of an accident and injury.

When leaving the vehicle, always take the SmartKey with you and lock the vehicle. Never leave children or animals unattended in the vehicle. Always keep the SmartKey out of reach of children.

- ▶ If the transmission is in position **D** or **R**: push the DIRECT SELECT lever up or down to the first point of resistance.
- ▶ If the transmission is in position **P**: depress the brake pedal and push the DIRECT SELECT lever up or down to the first point of resistance.

If you switch the engine off with the transmission in position **R** or **D**, the automatic transmission shifts to **N** automatically.

With the SmartKey: if you then open the driver's door or the front-passenger door or remove the SmartKey from the ignition, the automatic transmission shifts to **P** automatically.

With the Start/Stop button: if you then open the driver's door or the front-passenger door, the automatic transmission shifts to **P** automatically.

If you want the automatic transmission to remain in neutral **N**, e.g. when having the vehicle cleaned in an automatic car wash with a towing system:

- ▶ **Vehicles with the Start-Stop button:** remove the Start-Stop button from the ignition lock.
- ▶ Insert the SmartKey into the ignition lock.
- ▶ **All vehicles:** switch the ignition on.
- ▶ Depress the brake pedal and keep it depressed.
- ▶ Shift to neutral **N**.
- ▶ Release the brake pedal.
- ▶ Release the electric parking brake.
- ▶ Switch off the ignition and leave the SmartKey in the ignition lock.

Engaging drive position D

- ▶ If the transmission is in position **R** or **N**: push the DIRECT SELECT lever down past the first point of resistance.
- ▶ If the transmission is in position **P**: depress the brake pedal and push the DIRECT SELECT lever down past the first point of resistance.

Selector lever (Mercedes-AMG vehicles)

Overview of transmission positions

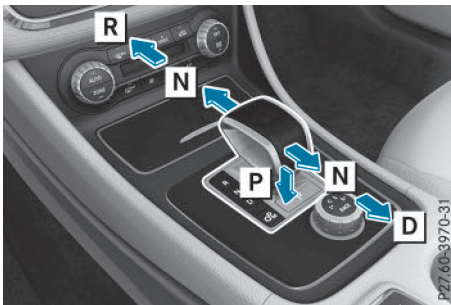

- P** Park position with parking lock
- R** Reverse gear
- N** Neutral
- D** Drive

Transmission position and drive program display

The current transmission position and drive program appear in the multifunction display.

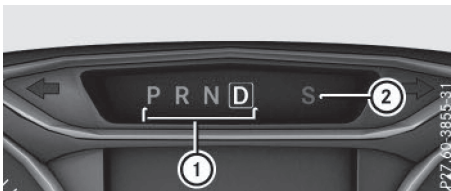

- ① Transmission position display
- ② Drive program display

If the transmission position display in the multifunction display is not working, you should pull away carefully to check whether the desired transmission position is engaged. Ideally, you should select transmission position **D** and drive program **C** or **S**.

Engaging park position P

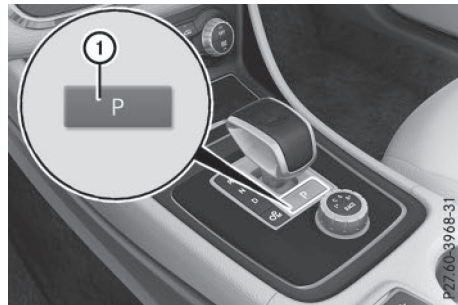

- ▶ When the vehicle is stationary, press button ①.

Engaging reverse gear R

- ❗ Only shift the automatic transmission to **R** when the vehicle is stationary.
- ▶ Depress the brake and keep it pressed.
- ▶ Push the selector lever forwards past the first point of resistance.

Transmission positions

P

Park position

This prevents the vehicle from rolling away when stopped.

Only shift the transmission into position **P** when the vehicle is stationary. The parking lock should not be used as a brake when parking. Always apply the electronic parking brake in addition to the parking lock in order to secure the vehicle.

If the vehicle electronics are malfunctioning, the transmission may be locked in position **P**. Have the vehicle electronics checked immediately at a qualified specialist workshop.

Park position **P** is automatically engaged if:

- you switch off the engine using the SmartKey and remove the SmartKey
- you switch off the engine using the SmartKey or using the Start/Stop button and open the driver's door or front-passenger door
- the driver's door is opened when the vehicle is stationary or driving at very low speed and the transmission is in position **D** or **R**

R

Reverse gear

Only shift the transmission into position **R** when the vehicle is stationary.

N

Neutral

Do not shift the transmission to **N** while driving. Otherwise, the automatic transmission could be damaged.

No power is transmitted from the engine to the drive wheels.

Releasing the brakes will allow you to move the vehicle freely, e.g. to push it or tow it.

If ESP® is deactivated or faulty: shift the transmission to position **N** if the vehicle is in danger of skidding, e.g. on icy roads.

If you switch the engine off with the transmission in position **R** or **D**, the automatic transmission shifts to **N** automatically.

! Rolling in neutral **N** can damage the drive train.

D

Drive

The automatic transmission changes gear automatically. All forward gears are available.

Driving tips

Changing gear

The automatic transmission shifts to the individual gears automatically when it is in transmission position **D**. This automatic gear shifting behavior is determined by:

- the selected drive program
- the position of the accelerator pedal
- the road speed

Accelerator pedal position

Your style of driving influences how the automatic transmission shifts gear:

- little throttle: early upshifts
- more throttle: late upshifts

Holding the vehicle stationary on uphill gradients

WARNING

If the clutch overheats, the electronic management system is automatically deactivated. This interrupts the power transmission. The vehicle may, for example, roll backwards on gradients. There is a risk of an accident.

Never hold the vehicle stationary on uphill gradients by depressing the accelerator.

The clutch may overheat if you hold the vehicle stationary on uphill gradients by depressing the accelerator pedal. If the clutch overheats, a warning tone sounds.

All vehicles (except Mercedes-AMG vehicles): the **Stop Vehicle Shift to 'P' Leave Engine Running** display message appears in the multifunction display. You will only be able to continue your journey once the clutch has cooled down and the display message in the multifunction display has disappeared.

Mercedes-AMG vehicles: the **Trans. Oil Overheated Drive on with Care** display message appears in the multifunction display. Do not hold the vehicle stationary on uphill gradients by depressing the accelerator pedal. Instead, only ever hold the vehicle stationary on uphill gradients by:

- depressing the brake pedal
- activating the HOLD function
- engaging the electric parking brake

Kickdown

Use kickdown for maximum acceleration.

- ▶ Depress the accelerator pedal beyond the pressure point. The automatic transmission shifts to a lower gear depending on the engine speed.
- ▶ Ease off the accelerator pedal once the desired speed is reached. The automatic transmission shifts back up.

Mercedes-AMG vehicles: it is only possible to use kickdown in the automatic drive program and the temporary manual drive program **M**. When manual drive program **M** is permanently activated, kickdown is not possible.

For further information on kickdown in manual drive program **M** (> page 137).

Rocking the vehicle free

Shifting the transmission repeatedly between gears **D** and **R** may help to free the vehicle if it has become stuck in slush or snow. The vehicle's engine management system limits the speed to a maximum of 5 mph (9 km/h) when shifting back and forth. To shift back and forth between transmission positions **D** and **R**, move the DIRECT SELECT lever up and down past the point of resistance.

Drive programs

All vehicles (except Mercedes-AMG vehicles)

Drive program C (Comfort)

Drive program **C** is characterized by the following:

- the vehicle delivers comfortable, economical handling characteristics.
- the vehicle pulls away more gently in forward and reverse gears, unless the accelerator pedal is depressed fully.
- the vehicle has improved driving stability, for example on slippery road surfaces.
- optimal fuel consumption resulting from the automatic transmission shifting up sooner. The vehicle is driven in the low engine speed range and the wheels are less likely to spin.

Drive program S (Sport)

Drive program **S** is characterized by the following:

- sporty engine settings.
- the automatic transmission shifts up later. The fuel consumption possibly being higher as a result of the later automatic transmission shift points.

Drive program I (Individual)

In drive program **I** the following properties of the drive program can be selected:

- the drive (engine and transmission management)
- the suspension (vehicles with damping system or AMG adaptive sport suspension system)
- the steering
- the availability of the ECO start/stop function
- the climate control

Information about configuring drive program **I** with the multimedia system can be found in the Digital Operator's Manual.

- **i** To permanently select the gears in drive program **I** using the steering wheel paddle shifters, select the **M** (manual) setting for the drive.

Drive program E (Economy)

Drive program **E** is characterized by the following:

- comfort-oriented engine settings.
- optimal fuel consumption resulting from the automatic transmission shifting up sooner.
- the vehicle pulls away more gently in forward and reverse gears, unless the accelerator pedal is depressed fully.
- the vehicle has improved driving stability, for example on slippery road surfaces.
- the automatic transmission shifting up sooner. This results in the vehicle being driven at lower engine speeds and the wheels being less likely to spin.
- gliding mode is activated automatically when engine-internal conditions are fulfilled and the accelerator is not depressed. At the same time the transmission's clutch opens and the vehicle rolls freely using its kinetic energy. As a result great distances can be completed without the engine brake and fuel consumption reduced.

- **i** The availability of gliding mode depends on various factors, including the following:
 - the engine and transmission temperature
 - the downhill gradient
 - the vehicle speed
 - performing regular adaptation functions

When you depress the brake pedal, gliding mode is deactivated, depending on pedal pressure.

When you activate cruise control or Distance Pilot DISTRONIC, gliding mode is not available.

Mercedes-AMG vehicles**Drive program I (Individual)**

In drive program **I** the following properties of the drive program can be selected:

- the drive (engine management)
- the transmission management
- the suspension (vehicles with AMG adaptive sport suspension system)
- ESP®

Information about configuring drive program **I** with the multimedia system can be found in the Digital Operator's Manual.

Drive program C (Comfort)

Drive program **C** is characterized by the following:

- the vehicle delivers comfortable, economical handling characteristics.
- the vehicle pulls away more gently in forward and reverse gears, unless the accelerator pedal is depressed fully.
- the vehicle has improved driving stability, for example on slippery road surfaces.
- optimal fuel consumption resulting from the automatic transmission shifting up sooner. The vehicle is driven in the low engine speed range and the wheels are less likely to spin.
- gliding mode is available.
- the ECO start/stop function is available.

Drive program S (Sport)

Drive program **S** is characterized by the following:

- the vehicle exhibits sporty driving characteristics.
- the automatic transmission shifts up later. The fuel consumption possibly being higher as a result of the later automatic transmission shift points.
- the suspension exhibits stiff springing and damping settings (vehicles with AIR adaptive sport suspension system).

- gliding mode is not available.
- the ECO start/stop function is not available.

Drive program S+ (Sport Plus)

Drive program **S+** is characterized by the following:

- the vehicle exhibits particularly sporty driving characteristics.
- the automatic transmission shifts up later.
- the fuel consumption possibly being higher as a result of the later automatic transmission shift points.
- the suspension exhibits particularly stiff springing and damping settings (vehicles with AMG adaptive sport suspension system).
- gliding mode is not available.
- the ECO start/stop function is not available.

Drive program RACE (vehicles with AMG adaptive sport suspension system)

The **RACE** drive program is characterized by the following:

- the vehicle exhibits driving characteristics suitable for the racetrack.
- all vehicle systems are set for maximum sportiness.
- the automatic transmission shifts up later.
- the fuel consumption possibly being higher as a result of the later automatic transmission shift points.
- the suspension exhibits particularly hard springing and damping settings.
- gliding mode is not available.
- the ECO start/stop function is not available.

Manual gear shifting

General notes

You can change gear yourself using the steering wheel paddle shifters. The transmission must be in position **D**.

Depending on which steering wheel paddle shifter is pulled, the automatic transmission immediately shifts into the next gear down or up, if permitted.

Mercedes-AMG vehicles: to use manual shifting, you have two options:

- temporary setting
- permanent setting

If you activate manual gearshifting, the multi-function display will show the current gear instead of transmission position **D**.

If manual gearshifting is deactivated, the gears will be selected automatically.

Temporary setting

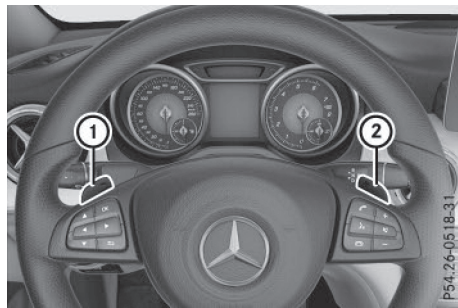

► **To activate:** shift the DIRECT SELECT lever to position **D**.

► Pull steering wheel paddle shifter ① or ②.

Temporary setting will be active for a certain amount of time. Under certain conditions the minimum amount of time is extended, e.g. in the case of lateral acceleration, during an overrun phase or when driving on steep terrain.

► **To deactivate:** pull steering wheel paddle shifter ② and hold it in place.

or

► Use the DIRECT SELECT lever to switch the transmission position.

or

► All vehicles (except Mercedes-AMG vehicles): use the DYNAMIC SELECT button to change the drive program.

Mercedes-AMG vehicles: use the DYNAMIC SELECT controller to change the drive program.

Permanent setting (Mercedes-AMG vehicles)

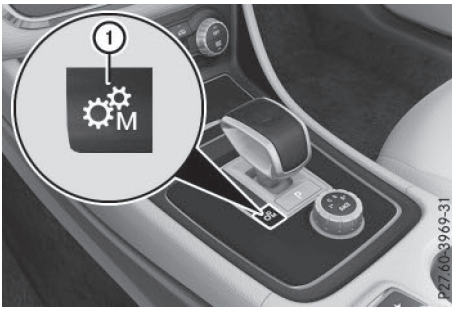

- ▶ **To activate:** shift the selector lever to position P.
 - ▶ Press button ①.
 - ▶ **To deactivate:** press button ①.
- or
- ▶ If position D (automatic transmission) is selected for the transmission in drive program I: shift to drive program I with the DYNAMIC SELECT controller.

Shifting gears

! **Mercedes-AMG vehicles:** the automatic transmission does not shift up automatically even when the engine limiting speed for the current gear is reached. When the engine limiting speed is reached, the fuel supply is cut to prevent the engine from overrevving. Always make sure that the engine speed does not reach the red area of the tachometer. There is otherwise a risk of engine damage.

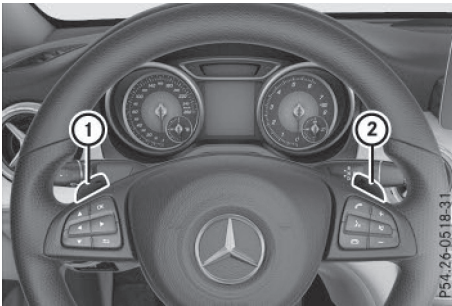

- ▶ **To shift up:** pull steering wheel paddle shifter ②. The automatic transmission shifts up to the next gear.

All vehicles (except Mercedes-AMG vehicles): if the maximum engine speed on the currently engaged gear is reached and you continue to accelerate, the automatic transmission automatically shifts up in order to prevent engine damage.

- ▶ **To shift down:** pull steering wheel paddle shifter ①. The automatic transmission shifts down to the next gear. Automatic down shifting occurs when coasting. If the engine exceeds the maximum engine speed when shifting down, the automatic transmission protects against engine damage by not shifting down.

Shift recommendation



The gearshift recommendations assist you in adopting an economical driving style. The recommended gear is shown in the multifunction display.

- ▶ Shift to recommended gear ② according to gearshift recommendation ① when shown in the multifunction display.

Upshifting (Mercedes-AMG vehicles)

! The automatic transmission does not shift up automatically even when the engine limiting speed for the current gear is reached. When the engine limiting speed is reached, the fuel supply is cut to prevent the engine from overrevving. Always make sure that the engine speed does not reach the red area of the tachometer. There is otherwise a risk of engine damage.



Before the engine speed reaches the red area, an upshift indicator will be shown in the multifunction display.

- ▶ Shift to recommended gear ① when message ② is shown in the multifunction display.

Kickdown

- ▶ For maximum acceleration, depress the accelerator pedal beyond the pressure point. The automatic transmission shifts to a lower gear depending on the engine speed.
- ▶ Shift back up once the desired speed is reached.

During kickdown, you cannot shift gears using the steering wheel paddle shifters.

If you apply full throttle, the automatic transmission shifts up to the next gear when the maximum engine speed is reached. This prevents the engine from overrevving.

Mercedes-AMG vehicles: it is only possible to use kickdown in temporary manual drive program **M**. When manual drive program **M** is permanently activated, kickdown is not possible.

Problems with the transmission

Problem	Possible causes/consequences and ▶ Solutions
The transmission has problems shifting gear.	The transmission is losing oil. ▶ Have the transmission checked at a qualified specialist workshop immediately.
The acceleration ability is deteriorating. The transmission no longer shifts into all of the gears. Reverse gear can no longer be engaged.	The transmission is in emergency mode. ▶ Stop the vehicle. ▶ Shift the transmission to position P . ▶ Switch off the engine. ▶ Wait at least ten seconds before restarting the engine. ▶ Shift the transmission to position D . ▶ Have the transmission checked at a qualified specialist workshop immediately.

Refueling

Important safety notes

WARNING

Fuel is highly flammable. If you handle fuel incorrectly, there is a risk of fire and explosion.

You must avoid fire, open flames, creating sparks and smoking. Switch off the engine and, if applicable, the auxiliary heating before refueling.

WARNING

Fuel is poisonous and hazardous to health. There is a risk of injury.

You must make sure that fuel does not come into contact with your skin, eyes or clothing and that it is not swallowed. Do not inhale fuel vapors. Keep fuel away from children.

If you or others come into contact with fuel, observe the following:

- Wash away fuel from skin immediately using soap and water.
- If fuel comes into contact with your eyes, immediately rinse them thoroughly with clean water. Seek medical assistance without delay.
- If fuel is swallowed, seek medical assistance without delay. Do not induce vomiting.
- Immediately change out of clothing which has come into contact with fuel.

WARNING

Electrostatic buildup can create sparks and ignite fuel vapors. There is a risk of fire and explosion.

Always touch the vehicle body before opening the fuel filler flap or touching the fuel pump nozzle. Any existing electrostatic buildup is thereby discharged.

! Do not use diesel to refuel vehicles with a gasoline engine. Do not switch on the ignition if you accidentally refuel with the wrong fuel. Otherwise, the fuel will enter the fuel system. Even small amounts of the wrong fuel could result in damage to the fuel system and the engine. Notify a qualified specialist workshop and have the fuel tank and fuel lines drained completely.

! Overfilling the fuel tank could damage the fuel system.

! Take care not to spill any fuel on painted surfaces. You could otherwise damage the paintwork.

! Use a filter when adding fuel from a fuel can. The fuel lines and/or the fuel injection system could otherwise be blocked by particles from the fuel can.

Do not get into the vehicle again during the refueling process. Otherwise, electrostatic charge could build up again.

If you overfill the fuel tank, fuel could spray out when the fuel pump nozzle is removed.

For further information on fuel and fuel quality (▷ page 309).

Refueling

General information

Pay attention to the important safety notes (▷ page 137).

The fuel filler flap is unlocked/locked automatically when you unlock/lock the vehicle with the SmartKey.

The position of the fuel filler cap is displayed  in the instrument cluster. The arrow on the filling pump indicates the side of the vehicle.

Opening the fuel filler flap

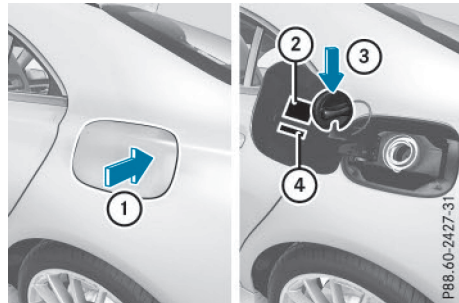

- ① To open the fuel filler flap
- ② Tire pressure table
- ③ To insert the fuel filler cap
- ④ Instruction label for fuel type to be refueled

▶ Switch off the engine.

▶ Remove the SmartKey from the ignition lock. or, in vehicles with KEYLESS-GO start-function or KEYLESS-GO

▶ Open the driver's door.

The vehicle electronics now have status **0**.

This is the same as the SmartKey having been removed.

▶ Press the fuel filler flap in the direction of arrow ①.

The fuel filler flap swings up.

- ▶ Turn the fuel filler cap counterclockwise and remove it.
- ▶ Insert the fuel filler cap into the holder on the inside of fuel filler flap ②.
- ▶ Completely insert the filler neck of the fuel pump nozzle into the tank, hook in place and refuel.
- ▶ Only fill the tank until the pump nozzle switches off.

Do not add any more fuel after the pump stops filling for the first time. Otherwise, fuel may leak out.

Closing the fuel filler flap

- ▶ Replace the cap on the filler neck and turn clockwise until it engages audibly.
- ▶ Close the fuel filler flap.

Close the fuel filler flap before locking the vehicle.

If you are driving with the fuel filler cap open, the  reserve fuel warning lamp flashes. A message appears in the multifunction display (▷ page 204).

In addition, the  Check Engine warning lamp may light up (▷ page 222).

For further information on warning and indicator lamps in the instrument cluster, see (▷ page 222).

Problems with fuel and the fuel tank

Problem	Possible causes/consequences and ► Solutions
Fuel is leaking from the vehicle.	<p>The fuel line or the fuel tank is faulty.</p> <p> WARNING</p> <p>Risk of explosion or fire.</p> <ul style="list-style-type: none"> ▶ Apply the electric parking brake. ▶ Switch off the engine. ▶ Remove the SmartKey from the ignition lock. <p>or, in vehicles with KEYLESS-GO start-function or KEYLESS-GO</p> <ul style="list-style-type: none"> ▶ Open the driver's door. <p>The vehicle electronics now have status 0. This is the same as the SmartKey having been removed.</p> <ul style="list-style-type: none"> ▶ Do not restart the engine under any circumstances. ▶ Consult a qualified specialist workshop.
The fuel filler flap cannot be opened.	<p>The fuel filler flap is not unlocked.</p> <ul style="list-style-type: none"> ▶ Unlock the vehicle (▷ page 69). <p>The SmartKey battery is discharged or nearly discharged.</p> <ul style="list-style-type: none"> ▶ Unlock the vehicle using the mechanical key (▷ page 71). <p>The fuel filler flap is unlocked, but the opening mechanism is jammed.</p> <ul style="list-style-type: none"> ▶ Consult a qualified specialist workshop.

Parking

Important safety notes

WARNING

Flammable material such as leaves, grass or twigs may ignite if they come into contact with hot parts of the exhaust system or exhaust gas flow. There is a risk of fire.

Park the vehicle so that no flammable materials come into contact with parts of the vehicle which are hot. Take particular care not to park on dry grassland or harvested grain fields.

WARNING

If you leave children unsupervised in the vehicle, they could set it in motion by, for example:

- release the parking brake.
- shift the automatic transmission out of the parking position **P**.
- start the engine.

In addition, they may operate vehicle equipment and become trapped. There is a risk of an accident and injury.

When leaving the vehicle, always take the SmartKey with you and lock the vehicle. Never leave children unsupervised in the vehicle.

! Always secure the vehicle correctly against rolling away. Otherwise, the vehicle or its drivetrain could be damaged.

To ensure that the vehicle is secured against rolling away unintentionally:

- the electric parking brake must be applied.
- the transmission must be in position **P** and the transmission position display must show **P**.
- the SmartKey must be removed from the ignition lock.
- on uphill or downhill gradients, the front wheels must be turned towards the curb.

Switching off the engine

Important safety notes

WARNING

The automatic transmission switches to neutral position **N** when you switch off the engine. The vehicle may roll away. There is a risk of an accident.

After switching off the engine, always switch to parking position **P**. Prevent the parked vehicle from rolling away by applying the parking brake.

Automatic transmission

- ▶ Apply the electric parking brake.
- ▶ **All vehicles (except Mercedes-AMG vehicles):** shift the transmission to position **P**.

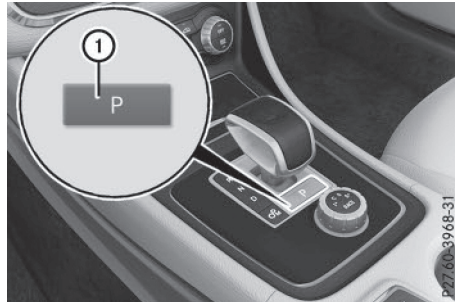

- ▶ **Mercedes-AMG vehicles:** press button ①.
- ▶ **With the SmartKey:** turn the SmartKey to position **0** in the ignition lock and remove it. The immobilizer is activated.
- ▶ **With the Start/Stop button:** press the Start/Stop button (▶ page 121). The engine stops and all the indicator lamps in the instrument cluster go out. When the driver's door is closed, this corresponds to SmartKey position **1**. When the driver's door is open, this corresponds to SmartKey position **0**: "Key removed".

If you switch the engine off with the transmission in position **R** or **D**, the automatic transmission shifts to **N** automatically.

With the SmartKey: if you then open the driver's door or the front-passenger door or remove

the SmartKey from the ignition, the automatic transmission shifts to **P** automatically.

With the Start/Stop button: if you then open the driver's door or the front-passenger door, the automatic transmission shifts to **P** automatically.

If you want the automatic transmission to remain in neutral **N**, e.g. when having the vehicle cleaned in an automatic car wash with a towing system:

- ▶ **Vehicles with the Start-Stop button:** remove the Start-Stop button from the ignition lock.
- ▶ Insert the SmartKey into the ignition lock.
- ▶ **All vehicles:** switch the ignition on.
- ▶ Depress the brake pedal and keep it depressed.
- ▶ Shift to neutral **N**.
- ▶ Release the brake pedal.
- ▶ Release the electric parking brake.
- ▶ Switch off the ignition and leave the SmartKey in the ignition lock.

Electric parking brake

General notes

WARNING

If you leave children unsupervised in the vehicle, they could set it in motion by, for example:

- release the parking brake.
- shift the automatic transmission out of the parking position **P**.
- start the engine.

In addition, they may operate vehicle equipment and become trapped. There is a risk of an accident and injury.

When leaving the vehicle, always take the SmartKey with you and lock the vehicle. Never leave children unsupervised in the vehicle.

The function of the electric parking brake is dependent on the on-board voltage. If the on-board voltage is low or there is a malfunction in the system, it may not be possible to apply the released parking brake.

- ▶ If this is the case, only park the vehicle on level ground and secure it to prevent it rolling away.
- ▶ Shift the automatic transmission to position **P**.

It may not be possible to release an applied parking brake if the on-board voltage is low or there is a malfunction in the system. Contact a qualified specialist workshop.

The electric parking brake performs a function test at regular intervals while the engine is switched off. The sounds that can be heard while this is occurring are normal.

Applying or releasing manually



- ▶ **To engage:** push handle ①.

When the electric parking brake is applied, the red **PARK** (USA only) or **(P)** (Canada only) indicator lamp lights up in the instrument cluster.

The electric parking brake can also be applied when the SmartKey is removed.

- ▶ **To release:** pull handle ①.

The red **PARK** (USA only) or **(P)** (Canada only) indicator lamp in the instrument cluster goes out.

The electric parking brake can only be released:

- when the SmartKey is in position **1** or **2** in the ignition lock (▶ page 121) or
- if the ignition was switched on using the Start/Stop button

Applying automatically

The electric parking brake is automatically applied when the transmission is in position **P** and:

- the engine is switched off or
- the driver is not wearing a seat belt and the driver's door is opened

To prevent the electric parking brake from being automatically applied, pull handle ①.

The electric parking brake is also engaged automatically if:

- Distance Pilot DISTRONIC brings the vehicle to a standstill or
- the HOLD function is keeping the vehicle stationary
- Parking Pilot is keeping the vehicle stationary

In addition, at least one of the following conditions must be fulfilled:

- the engine is switched off
- the driver is not wearing a seat belt and the driver's door is opened
- there is a system malfunction
- the power supply is insufficient
- the vehicle is stationary for a lengthy period

The red **PARK** (USA only) or **(P)** (Canada only) indicator lamp in the instrument cluster goes out.

The electric parking brake is not automatically engaged if the engine is switched off by the ECO start/stop function.

Releasing automatically

Your vehicle's electric parking brake is automatically released if all of the following conditions are met:

- the engine is running.
- the transmission is in position **D** or **R**.
- the seat belt has been fastened.
- you depress the accelerator pedal.

If the transmission is in position **R**, the trunk lid must be closed.

If your seat belt is not fastened, the following conditions must be fulfilled to automatically release the electric parking brake:

- the driver's door is closed.
- you have shifted out of transmission position **P** or you have previously driven faster than 2 mph (3 km/h).

Ensure that you do not depress the accelerator pedal unintentionally. Otherwise the parking brake will be released and the vehicle will start to move.

Emergency braking

The vehicle can also be braked during an emergency by using the electric parking brake.

- ▶ While driving, push handle ① of the electric parking brake (▷ page 141). The vehicle is braked as long as you keep handle ① of the electric parking brake pressed. The longer the electric parking brake handle ① is depressed, the greater the braking force.

During braking:

- a warning tone sounds
- the **Release Parking Brake** message appears
- the red **PARK** (USA only) or **(P)** (Canada only) indicator lamp in the instrument cluster flashes

When the vehicle has been braked to a standstill, the electric parking brake is engaged.

Parking the vehicle for a long period

If you leave the vehicle parked for longer than four weeks, the battery may be damaged by exhaustive discharging.

If you leave the vehicle parked for longer than six weeks, the vehicle may suffer damage as a result of lack of use.

- ▶ Visit a qualified specialist workshop and seek advice.

- ⓘ You can obtain information about trickle chargers from a qualified specialist workshop.

Driving tips

General notes

Important safety notes

WARNING

If you switch off the ignition while driving, safety-relevant functions are only available with limitations, or not at all. This could affect, for example, the power steering and the brake boosting effect. You will require considerably more effort to steer and brake. There is a risk of an accident.

Do not switch off the ignition while driving.

WARNING

If you operate mobile communication equipment while driving, you will be distracted from traffic conditions. You could also lose control of the vehicle. There is a risk of an accident.

Only operate this equipment when the vehicle is stationary.

Observe the legal requirements for the country in which you are driving. Some jurisdictions prohibit the driver from using a mobile phone while driving a vehicle.

If you make a call while driving, always use hands-free mode. Only operate the telephone when the traffic situation permits. If you are unsure, pull over to a safe location and stop before operating the telephone.

Bear in mind that at a speed of only 30 mph (approximately 50 km/h), the vehicle covers a distance of 44 ft (approximately 14 m) per second.

Drive sensibly – save fuel

Observe the following tips to save fuel:

- The tires should always be inflated to the recommended tire pressure.
- Remove unnecessary loads.
- Remove roof racks when they are not needed.
- Warm up the engine at low engine speeds.
- Avoid frequent acceleration or braking.
- Have all maintenance work carried out as indicated by the service intervals in the Main-

tenance Booklet or by the service interval display.

Fuel consumption also increases when driving in cold weather, in stop-start traffic and in hilly terrain.

Drinking and driving

WARNING

Drinking and driving and/or taking drugs and driving are very dangerous combinations. Even a small amount of alcohol or drugs can affect your reflexes, perceptions and judgment.

The possibility of a serious or even fatal accident is greatly increased when you drink or take drugs and drive.

Do not drink or take drugs and drive or allow anyone to drive who has been drinking or taking drugs.

Emission control

WARNING

Combustion engines emit poisonous exhaust gases such as carbon monoxide. Inhaling these exhaust gases leads to poisoning. There is a risk of fatal injury. Therefore never leave the engine running in enclosed spaces without sufficient ventilation.

Certain engine systems are designed to keep the level of poisonous components in exhaust fumes within legal limits.

These systems only work at peak efficiency if they are serviced exactly in accordance with the manufacturer's specifications. Always have work on the engine carried out at a qualified specialist workshop. Mercedes-Benz recommends that you use an authorized Mercedes-Benz Center for this purpose. In particular, work relevant to safety or on safety-related systems must be carried out at a qualified specialist workshop.

The engine settings must not be changed under any circumstances. Furthermore, all specific service work must be carried out at regular intervals and in accordance with the Mercedes-Benz service requirements. Details can be found in the Maintenance Booklet.

ECO display

The ECO display shows you how economical your driving style is. The ECO display assists you in achieving the most economical driving style for the selected settings and prevailing conditions. Your driving style can significantly influence the vehicle's consumption.



- ① Acceleration
- ② Coasting
- ③ Constant
- ④ Additional range achieved

Range ④ is shown under **Bonus fr. Start** and represents the additional range achieved since the beginning of the journey as a result of an adapted driving style.

If the fuel level has dropped into the reserve range, the **Fuel Low** message is shown in the multifunction display instead of range ④. The  warning lamp in the instrument cluster also lights up (> page 222).

The ECO display consists of three sections, with an inner and outer area. The sections correspond to the following three categories:

- | | |
|---|--|
| ① | <p>Acceleration (evaluation of the acceleration processes):</p> <ul style="list-style-type: none"> • the outer area fills up and the inner area lights up green: moderate acceleration, especially at higher speeds • the outer area empties and the inner area is gray: sporty acceleration |
| ② | <p>Coasting (evaluation of all deceleration processes):</p> <ul style="list-style-type: none"> • the outer area fills up and the inner area lights up green: anticipatory driving, keeping your distance and early release of the accelerator. The vehicle can coast without use of the brakes. • the outer area empties and the inner area is gray: frequent heavy braking |
| ③ | <p>Constant (continuous evaluation over the entire journey):</p> <ul style="list-style-type: none"> • the outer area fills up and the inner area lights up green: constant speed and avoidance of unnecessary acceleration and deceleration • the outer area empties and the inner area is gray: fluctuations in speed |

The three inner areas display the current driving style and light up green as a result of a particularly economical driving style. Depending on the driving situation, up to two areas may light up simultaneously.

At the beginning of the journey, the three outer areas are empty and fill up as a result of economical driving. A higher level indicates a more economical driving style. If the three outer areas are completely filled at the same time, the driver has adopted the most economical driving style for the selected settings and prevailing conditions. The ECO display border lights up.

The ECO display does not indicate the actual fuel consumption. The additionally achieved range displayed under **Bonus fr. Start** does not indicate a fixed consumption reduction.

In addition to driving style, the actual consumption is affected by other factors, such as:

- Load
- Tire pressure
- Cold start
- Choice of route
- Active electrical consumers

These factors are not included in the ECO display.

An economical driving style specially requires driving at moderate engine speeds.

Achieving a higher value in the categories "Acceleration" and "Constant":

- observe the gearshift recommendations.
- drive the vehicle in drive program **C** or **E** (vehicles with a DYNAMIC SELECT button).

On long journeys at a constant speed, e.g. on the highway, only the outer area for "constant" will change.

The ECO display summarizes the driving style from the start of the journey to its completion. Therefore, there are more marked changes in the outer areas at the start of a journey. On longer journeys, there are fewer changes. For more marked changes, perform a manual reset (▷ page 178).

For more information on the ECO display, see (▷ page 177).

Braking

Important safety notes

WARNING

If you shift down on a slippery road surface in an attempt to increase the engine's braking effect, the drive wheels could lose their grip. There is an increased danger of skidding and accidents.

Do not shift down for additional engine braking on a slippery road surface.

Downhill gradients

 On long and steep gradients, you must reduce the load on the brakes by shifting to a lower gear in good time. This allows you to take advantage of engine braking. For this you must first activate manual gearshifting. This

helps you to avoid overheating the brakes and wearing them out excessively.

When you take advantage of engine braking, it is possible that a drive wheel will not rotate for some time, e.g. on a slippery road surface. This could cause damage to the drive train. This type of damage is not covered by the Mercedes-Benz warranty.

Briefly depressing the accelerator pedal on downhill gradients while the manual drive program **M** is temporarily activated: the automatic transmission may switch to the last active automatic drive program **E** or **S**. The automatic transmission may shift to a higher gear. This can reduce the engine's braking effect.

Heavy and light loads

WARNING

If you rest your foot on the brake pedal while driving, the braking system can overheat. This increases the stopping distance and can even cause the braking system to fail. There is a risk of an accident.

Never use the brake pedal as a footrest. Never depress the brake pedal and the accelerator pedal at the same time.

 Depressing the brake pedal constantly results in excessive and premature wear to the brake pads.

If the brakes have been subjected to a heavy load, do not stop the vehicle immediately. Drive on for a short while. This allows the airflow to cool the brakes more quickly.

Wet roads

If you have driven for a long time in heavy rain without braking, there may be a delayed reaction from the brakes when braking for the first time. This may also occur after the vehicle has been washed or driven through deep water. You have to depress the brake pedal more firmly. Maintain a greater distance from the vehicle in front.

After driving on a wet road or having the vehicle washed, brake firmly while paying attention to the traffic conditions. This will warm up the brake discs, thereby drying them more quickly and protecting them against corrosion.

Limited braking performance on salt-treated roads

If you drive on salted roads, a layer of salt residue may form on the brake discs and brake pads. This can result in a significantly longer braking distance.

- In order to prevent any salt build-up, apply the brakes occasionally while paying attention to the traffic conditions.
- Carefully depress the brake pedal at the beginning and end of a journey.
- Maintain a greater distance to the vehicle ahead.

Servicing the brakes

! The brake fluid level may be too low, if:

- if the red brake warning lamp lights up in the instrument cluster and
- you hear a warning tone while the engine is running

Observe additional warning messages in the multifunction display.

The brake fluid level may be too low due to brake pad wear or leaking brake lines.

Have the brake system checked immediately. Consult a qualified specialist workshop to arrange this.

! A function or performance test should only be carried out on a 2-axle dynamometer. If you wish to operate the vehicle on such a dynamometer, please consult a qualified specialist workshop in advance. You could otherwise damage the drive train or the brake system.

! As the ESP® system operates automatically, the engine and the ignition must be switched off (the SmartKey must be in position **0** or **1** in the ignition lock) if:

- the electric parking brake is tested on a brake dynamometer (for a maximum of ten seconds)
- the vehicle is towed with the front axle raised.

Braking triggered automatically by ESP® may seriously damage the brake system.

All checks and maintenance work on the brake system must be carried out at a qualified specialist workshop.

Have brake pads installed and brake fluid replaced at a qualified specialist workshop.

If the brake system has only been subject to moderate loads, you should test the functionality of your brakes at regular intervals.

You can find a description of Brake Assist (BAS) on (> page 60).

Mercedes-Benz recommends that you only have brake pads/linings installed on your vehicle which have been approved for Mercedes-Benz vehicles or which correspond to an equivalent quality standard. Brake pads/linings which have not been approved for Mercedes-Benz vehicles or which are not of an equivalent quality could affect your vehicle's operating safety.

Mercedes-Benz recommends that you only use brake fluid that has been specially approved for your vehicle by Mercedes-Benz, or which corresponds to an equivalent quality standard. Brake fluid which has not been approved for Mercedes-Benz vehicles or which is not of an equivalent quality could affect your vehicle's operating safety.

Checking brake lining thickness

You can measure the brake pad/lining thickness using a test gage. Color-coding (green or red) on the test gage allows you to determine whether the brake pad/lining thickness is still sufficient. The test gage is in the vehicle document wallet in the glove box.

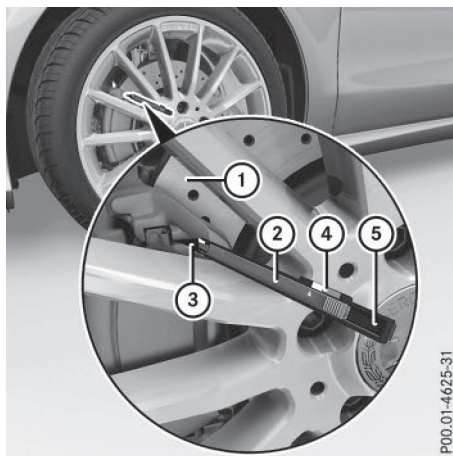

Front wheel

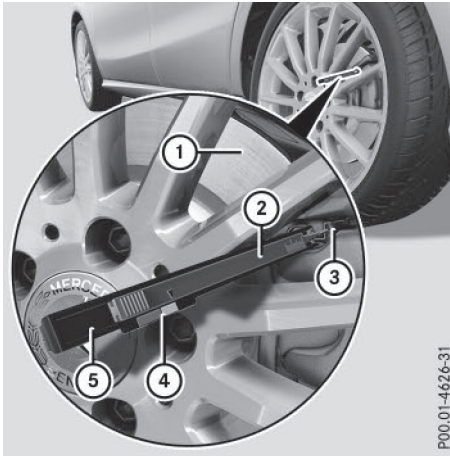

Rear wheel

- ▶ Bring the vehicle and wheels into a suitable position so that you can attach test gage ⑤.
- ▶ Secure the vehicle against rolling away (> page 140).
- ▶ Engage park position **P**.
- ▶ Switch off the engine.
- ▶ Place test gage ⑤ between the wheel's spokes on brake pad/lining ③.
- ▶ Hold test gage ⑤ vertically on brake disc ① and slide measuring pin ② onto brake disc ①.
- ▶ Check which color field ④ the arrow on measuring pin ② is pointing to.

Green: the brake pad/lining thickness is sufficient.

Red: the brake pad/lining thickness is not sufficient. Have the brake pads/lining checked at a qualified specialist workshop.

To avoid an inaccurate measurement:

- make sure you position the wheels suitably
- do not put the measuring pin on a recess in the brake disc

Driving on wet roads

Hydroplaning

If water has accumulated to a certain depth on the road surface, there is a danger of hydroplaning occurring, even if:

- you drive at low speeds
- the tires have adequate tread depth

For this reason, in the event of heavy rain or in conditions in which hydroplaning may occur, you must drive in the following manner:

- lower your speed
- avoid ruts
- avoid sudden steering movements
- brake carefully

Driving on flooded roads

! Do not drive through flooded areas. Check the depth of any water before driving through it. Drive slowly through standing water. Otherwise, water may enter the vehicle interior or the engine compartment. This can damage the electronic components in the engine or the automatic transmission. Water can also be drawn in by the engine's air suction nozzles and this can cause engine damage.

Winter driving

⚠ WARNING

If you shift down on a slippery road surface in an attempt to increase the engine's braking effect, the drive wheels could lose their grip. There is an increased danger of skidding and accidents.

Do not shift down for additional engine braking on a slippery road surface.

⚠ DANGER

If the exhaust pipe is blocked or adequate ventilation is not possible, poisonous gases such as carbon monoxide (CO) may enter the vehicle. This is the case, e.g. if the vehicle becomes trapped in snow. There is a risk of fatal injury.

If you leave the engine or the auxiliary heating running, make sure the exhaust pipe and area around the vehicle are clear of snow. To ensure an adequate supply of fresh air, open a window on the side of the vehicle that is not facing into the wind.

Have your vehicle winter-proofed at a qualified specialist workshop at the onset of winter.

Drive particularly carefully on slippery road surfaces. Avoid sudden acceleration, steering and braking maneuvers. Do not use cruise control or Distance Pilot DISTRONIC.

If the vehicle threatens to skid or cannot be stopped when moving at low speed:

- ▶ Shift the transmission to position **N**.
- ▶ Try to bring the vehicle under control using corrective steering.

The outside temperature indicator is not designed to serve as an ice-warning device and is therefore unsuitable for that purpose. Changes in the outside temperature are displayed after a short delay.

Indicated temperatures just above the freezing point do not guarantee that the road surface is free of ice. The road may still be icy, especially in wooded areas or on bridges.

You should pay special attention to road conditions when temperatures are around freezing point.

For more information on driving with snow chains, see (▷ page 285).

For more information on driving with summer tires, see (▷ page 284).

Observe the notes in the "Winter operation" section (▷ page 284).

Driving systems

Cruise control

General notes

Cruise control maintains a constant road speed for you. It brakes automatically in order to avoid exceeding the set speed. On long and steep downhill gradients, especially if the vehicle is laden, you must select a low gear in good time. You need to have selected manual drive program **M** (▷ page 135). By doing so, you will make use of the braking effect of the engine. This

relieves the load on the brake system and prevents the brakes from overheating and wearing too quickly.

When the engine is running, you can use the cruise control lever to limit the speed to any speed between 20 mph (30 km/h) and the technically permitted maximum speed of the vehicle.

Use cruise control only if road and traffic conditions make it appropriate to maintain a steady speed for a prolonged period.

The speed indicated in the speedometer may differ slightly from the speed stored.

Important safety notes

If you fail to adapt your driving style, cruise control can neither reduce the risk of an accident nor override the laws of physics. Cruise control cannot take into account the road, traffic and weather conditions. Cruise control is only an aid. You are responsible for the distance to the vehicle in front, for vehicle speed, for braking in good time and for staying in your lane.

Do not use cruise control:

- in road and traffic conditions which do not allow you to maintain a constant speed e.g. in heavy traffic or on winding roads
- on slippery road surfaces. Braking or accelerating could cause the drive wheels to lose traction and the vehicle could then skid
- in poor visibility, e.g. due to fog, heavy rain or snow

If there is a change of drivers, advise the new driver of the speed stored.

Cruise control lever

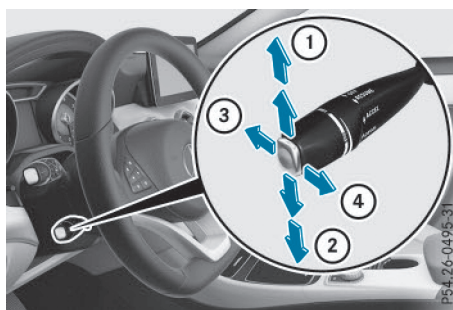

- ① Activates or increases speed
- ② Activates or reduces speed

- ③ Deactivates cruise control
- ④ Activates at the current speed/last stored speed

When you activate cruise control, the stored speed is shown in the multifunction display for five seconds.

Activation conditions

To activate cruise control, all of the following activation conditions must be fulfilled:

- the electric parking brake must be released.
- ESP® must be active, but not intervening.
- the transmission must be in position D.

Storing, maintaining and calling up a speed

Storing and maintaining the current speed

You can store the current speed if you are driving faster than 20 mph (30 km/h).

- ▶ Accelerate the vehicle to the desired speed.
- ▶ Briefly press the cruise control lever up ① or down ②.
- ▶ Remove your foot from the accelerator pedal. Cruise control is activated. The vehicle automatically maintains the stored speed.

i Cruise control may be unable to maintain the stored speed on uphill gradients. The stored speed is resumed when the gradient evens out. Cruise control maintains the stored speed on downhill gradients by automatically applying the brakes.

Storing the current speed or calling up the last stored speed

WARNING

If you call up the stored speed and it differs from the current speed, the vehicle accelerates or decelerates. If you do not know the stored speed, the vehicle could accelerate or brake unexpectedly. There is a risk of an accident.

Pay attention to the road and traffic conditions before calling up the stored speed. If you do not know the stored speed, store the desired speed again.

- ▶ Briefly pull the cruise control lever towards you ④.
- ▶ Remove your foot from the accelerator pedal. The first time cruise control is activated, it stores the current speed or regulates the speed of the vehicle to the previously stored speed.

Setting a speed

Keep in mind that it may take a brief moment until the vehicle has accelerated or braked to the speed set.

- ▶ **To adjust the set speed in 10 km/h/increments:** briefly press cruise control lever ① up beyond the pressure point for a higher speed, or down ② for a lower speed.

or

- ▶ Keep the cruise control lever pressed beyond the point of resistance until the desired speed is set. Press cruise control lever up ① for a higher speed or down ② for a lower speed.

- ▶ **To adjust the set speed in 1 km/h/increments:** briefly press cruise control lever up ① to the pressure point for a higher speed or down ② for a lower speed.

or

- ▶ Keep the cruise control lever pressed to the point of resistance until the desired speed is set. Press cruise control lever up ① for a higher speed or down ② for a lower speed.

i Cruise control is not deactivated if you depress the accelerator pedal. For example, if you accelerate briefly to overtake, cruise control adjusts the vehicle's speed to the last speed stored after you have finished overtaking.

Deactivating cruise control

There are several ways to deactivate cruise control:

- ▶ Briefly press the cruise control lever forwards ③.
- or
- ▶ Brake.

Cruise control is automatically deactivated if:

- the vehicle is secured with the electric parking brake
- you are driving at less than 20 mph (30 km/h)

- ESP® intervenes or you deactivate ESP®
- you shift the transmission to position **N** while driving

If cruise control is deactivated, you will hear a warning tone. You will see the **Cruise Control Off** message in the multifunction display for approximately five seconds.

- i** When you switch off the engine, the last speed stored is cleared.

Distance Pilot DISTRONIC

General notes

Distance Pilot DISTRONIC regulates the speed and automatically helps you maintain the distance to the vehicle detected in front. Vehicles are detected with the aid of the radar sensor system. Distance Pilot DISTRONIC brakes automatically to avoid exceeding the set speed or to maintain the designated distance from the vehicle in front.

If Distance Pilot DISTRONIC detects that there is a risk of a collision, you will be warned visually and acoustically. Without your intervention, Distance Pilot DISTRONIC cannot prevent a collision. An intermittent warning tone will then sound and the distance warning lamp will light up in the instrument cluster. Brake immediately in order to increase the distance to the vehicle in front or take evasive action provided it is safe to do so.

Distance Pilot DISTRONIC operates in the range between 0 mph (0 km/h) and 120 mph (200 km/h).

Change into a lower gear in good time on long and steep downhill gradients. This is especially important if the vehicle is laden. By doing so, you will make use of the braking effect of the engine. This relieves the load on the brake system and prevents the brakes from overheating and wearing too quickly.

Do not use Distance Pilot DISTRONIC on roads with steep gradients.

For Distance Pilot DISTRONIC to assist you when driving, the radar sensor system must be operational.

Since Distance Pilot DISTRONIC transmits radar waves, it can resemble the radar detectors of the responsible authorities. You can refer to the relevant chapter in the Operator's Manual if questions are asked about this.

- i** USA only: This device has been approved by the FCC as a "Vehicular Radar System". The radar sensor is intended for use in an automotive radar system only. Removal, tampering, or altering of the device will void any warranties, and is not permitted by the FCC. Do not tamper with, alter, or use in any non-approved way.

Any unauthorized modification to this device could void the user's authority to operate the equipment.

- i** Canada only: This device complies with RSS-210 of Industry Canada. Operation is subject to the following two conditions:
 1. This device may not cause harmful interference, and
 2. This device must accept any interference received, including interference that may cause undesired operation of the device.
 Removal, tampering, or altering of the device will void any warranties, and is not permitted. Do not tamper with, alter, or use in any non-approved way.

Any unauthorized modification to this device could void the user's authority to operate the equipment.

Important safety notes

WARNING

Distance Pilot DISTRONIC does not react to:

- people or animals
- stationary objects on the road, e.g. stopped or parked vehicles
- oncoming vehicles and crossing traffic

As a result, Distance Pilot DISTRONIC may neither give warnings nor intervene in such situations. There is a risk of an accident.

Always pay careful attention to the traffic situation and be ready to brake.

WARNING

Distance Pilot DISTRONIC cannot always clearly identify other road users and complex traffic situations.

In such cases, Distance Pilot DISTRONIC may:

- give an unnecessary warning and then brake the vehicle
- neither give a warning nor intervene
- accelerate or brake unexpectedly

There is a risk of an accident.

Continue to drive carefully and be ready to brake, especially if Distance Pilot DISTRONIC warns you.

WARNING

Distance Pilot DISTRONIC brakes your vehicle with up to 50% of the maximum possible deceleration. If this deceleration is not sufficient, Distance Pilot DISTRONIC alerts you with a visual and acoustic warning. There is a risk of an accident.

Apply the brakes yourself in these situations and try to take evasive action.

! When Distance Pilot DISTRONIC or the HOLD function is activated, the vehicle brakes automatically in certain situations. To avoid damage to the vehicle, deactivate Distance Pilot DISTRONIC and the HOLD function in the following or similar situations:

- when towing the vehicle
- in the car wash

If you fail to adapt your driving style, Distance Pilot DISTRONIC can neither reduce the risk of an accident nor override the laws of physics. Distance Pilot DISTRONIC cannot take into account road, weather or traffic conditions. Distance Pilot DISTRONIC is only an aid. You are responsible for the distance to the vehicle in front, for vehicle speed, for braking in good time and for staying in your lane.

Do not use Distance Pilot DISTRONIC:

- in road and traffic conditions which do not allow you to maintain a constant speed, e.g. in heavy traffic or on winding roads
- on slippery road surfaces. Braking or accelerating could cause the drive wheels to lose traction and the vehicle could then skid
- when there is poor visibility, e.g. due to fog, heavy rain or snow

Distance Pilot DISTRONIC may not detect narrow vehicles driving in front, e.g. motorcycles, or vehicles driving on a different line.

In particular, the detection of obstacles can be impaired if:

- there is dirt on the sensors or anything else covering the sensors
- there is snow or heavy rain
- there is interference by other radar sources
- there are strong radar reflections, for example, in parking garages

If Distance Pilot DISTRONIC no longer detects a vehicle in front, it may unexpectedly accelerate to the speed stored.

This speed may:

- be too high if you are driving in a filter lane or an exit lane
- be so high when driving in the right-hand lane that you overtake vehicles in the left-hand lane
- be so high in the left lane that you pass vehicles driving in the right lane

If there is a change of drivers, advise the new driver of the speed stored.

Cruise control lever

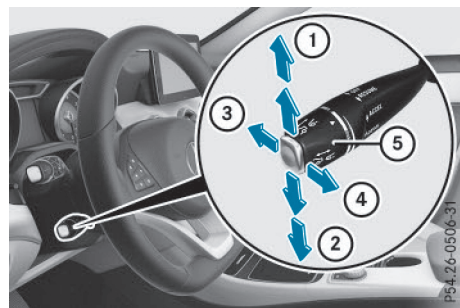

- ① Stores the current speed or a higher speed
- ② Stores the current speed or a lower speed
- ③ Deactivates Distance Pilot DISTRONIC
- ④ Stores the current speed or calls up the last stored speed
- ⑤ Sets a specified minimum distance

Activating Distance Pilot DISTRONIC

Activation conditions

! When Distance Pilot DISTRONIC or the HOLD function is activated, the vehicle brakes automatically in certain situations. To avoid damage to the vehicle, deactivate Distance Pilot DISTRONIC and the HOLD function in the following or similar situations:

- when towing the vehicle
- in the car wash

To activate Distance Pilot DISTRONIC, the following conditions must be fulfilled:

- the engine must be started. It may take up to two minutes of driving before Distance Pilot DISTRONIC is ready for use.
- the electric parking brake must be released.
- ESP® must be active, but not intervening.
- Parking Pilot must not be activated.
- the transmission must be in position **D**.
- the driver's door must be closed when you shift from **P** to **D** or your seat belt must be fastened.
- the front-passenger door must be closed.
- the vehicle must not skid.

Activating

- ▶ Briefly pull the cruise control lever towards you ④, up ① or down ②. Distance Pilot DISTRONIC is activated.
- ▶ Keep the cruise control lever pressed up ① or down ② until the desired speed is set.
- ▶ Remove your foot from the accelerator pedal. Your vehicle adapts its speed to that of the vehicle in front, but only up to the desired stored speed.

i If you do not fully release the accelerator pedal, the **Distance Pilot Passive** message appears in the multifunction display. The set distance to a slower-moving vehicle in front will then not be maintained. You will be driving at the speed you determine by the position of the accelerator pedal.

You can also activate Distance Pilot DISTRONIC when stationary. The lowest speed that can be set is 20 mph (30 km/h).

Driving with Distance Pilot DISTRONIC

Activating at the current speed/last stored speed

⚠ WARNING

If you call up the stored speed and it differs from the current speed, the vehicle accelerates or decelerates. If you do not know the stored speed, the vehicle could accelerate or brake unexpectedly. There is a risk of an accident.

Pay attention to the road and traffic conditions before calling up the stored speed. If you do not know the stored speed, store the desired speed again.

- ▶ Briefly pull the cruise control lever towards you ④.
- ▶ Remove your foot from the accelerator pedal. The first time Distance Pilot DISTRONIC is activated, it stores the current speed or regulates the speed of the vehicle to the previously stored speed.

Pulling away and driving

▶ **If you want to pull away with Distance Pilot DISTRONIC:** remove your foot from the brake pedal.

▶ Briefly pull the cruise control lever towards you ④.

or

▶ **If Distance Pilot DISTRONIC is activated:** accelerate briefly.

Your vehicle pulls away and adapts its speed to that of the vehicle in front. If no vehicle is detected in front, your vehicle accelerates to the set speed.

The vehicle can also pull away when it is facing an unidentified obstacle or is driving on a different line from another vehicle. The vehicle then brakes automatically. Be ready to brake at all times.

If there is no vehicle in front, Distance Pilot DISTRONIC operates in the same way as cruise control.

If Distance Pilot DISTRONIC detects a slower-moving vehicle in front, it brakes your vehicle. In this way, the distance you have selected is maintained.

If Distance Pilot DISTRONIC detects a faster-moving vehicle in front, it increases the driving speed. However, the vehicle is only accelerated up to the speed you have stored.

- i** Distance Pilot DISTRONIC is deactivated when you depress the brake, except when the vehicle is stationary.

Selecting the drive program

Distance Pilot DISTRONIC supports a sporty driving style when you select the **S+** drive program (Mercedes-AMG vehicles only), **S** (▷ page 133) or the manual drive program (▷ page 135). Acceleration behind the vehicle in front or to the set speed is then noticeably more dynamic. If you have selected the **E** (Mercedes-AMG vehicles: **C**) drive program, the vehicle accelerates more gently. This setting is recommended in stop-and-start traffic.

Changing lanes

If when driving on multilane roads you wish to change to the overtaking lane, Distance Pilot DISTRONIC supports you if:

- you are driving faster than 45 mph (70 km/h)
- Distance Pilot DISTRONIC is maintaining the distance to a vehicle in front
- you switch on the appropriate turn signal
- Distance Pilot DISTRONIC does not currently detect a danger of collision

If these conditions are fulfilled, your vehicle is accelerated. Acceleration will be interrupted if changing lanes takes too long or if the distance between your vehicle and the vehicle in front becomes too small.

Stopping

If Distance Pilot DISTRONIC detects that the vehicle in front is stopping, it brakes your vehicle until it is stationary.

Once your vehicle is stationary, it remains stationary and you do not need to depress the brake.

- i** After a time, the electric parking brake secures the vehicle and relieves the service brake.
- i** Depending on the specified minimum distance, your vehicle will come to a standstill at a sufficient distance behind the vehicle in front. The specified minimum distance is set using the control on the cruise control lever.

When Distance Pilot DISTRONIC is activated, the transmission is shifted automatically to position **P** if:

- the driver's seat belt is not fastened and the driver's door is open.
- the engine is switched off, unless it is automatically switched off by the ECO start/stop function.

The electric parking brake secures the vehicle automatically if Distance Pilot DISTRONIC is activated when the vehicle is stationary and:

- a system malfunction occurs.
- the power supply is insufficient.

If a malfunction occurs, the transmission may also shift into position **P** automatically.

Setting a speed

Keep in mind that it may take a brief moment until the vehicle has accelerated or braked to the speed set.

- ▶ Press the cruise control lever up **①** for a higher speed or down **②** for a lower speed.
- ▶ **To adjust the set speed in 1 mph/increments (1 km/h/increments):** briefly press the cruise control lever up **①** or down **②** to the pressure point.
The last stored speed increases or decreases in 1 mph (1 km/h) increments.
- ▶ **To adjust the set speed in 5 mph/increments (10 km/h/increments):** briefly press the cruise control lever up **①** or down **②** to the pressure point.
The last stored speed increases or decreases in 5 mph (10 km/h) increments.

- i** Distance Pilot DISTRONIC is not deactivated if you depress the accelerator pedal. If you accelerate to overtake, Distance Pilot DISTRONIC adjusts the vehicle's speed to the last speed stored after you have finished overtaking.

Setting a specified minimum distance

You can set the specified minimum distance for Distance Pilot DISTRONIC by varying the time span between one and two seconds. With this function you can set the minimum distance that Distance Pilot DISTRONIC maintains to the vehicle in front, dependent on vehicle speed. You can see this distance in the multifunction display (▷ page 154).

The specified minimum distance can be changed while Distance Pilot DISTRONIC is switched on or off.

- ❗ Make sure that you maintain the minimum distance to the vehicle in front as required by law. Adjust the distance to the vehicle in front if necessary.

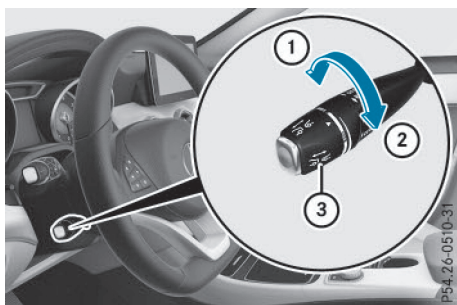

- ▶ **To increase:** turn control ③ in direction ②. Distance Pilot DISTRONIC then maintains a greater distance between your vehicle and the vehicle in front.
- ▶ **To decrease:** turn control ③ in direction ①. Distance Pilot DISTRONIC then maintains a shorter distance between your vehicle and the vehicle in front.

Deactivating Distance Pilot DISTRONIC



There are several ways to deactivate Distance Pilot DISTRONIC:

- ▶ Briefly press the cruise control lever forwards ①.

or

- ▶ Brake, unless the vehicle is stationary

When you deactivate Distance Pilot DISTRONIC, the **Distance Pilot Off** message appears in

the multifunction display for approximately five seconds.

- ❗ The last speed stored remains stored until you switch off the engine. Distance Pilot DISTRONIC is not deactivated if you depress the accelerator pedal.

Distance Pilot DISTRONIC is automatically deactivated if:

- you engage the electric parking brake or if the vehicle is automatically secured with the electric parking brake
- ESP® intervenes or you deactivate ESP®
- the transmission is in the **P**, **R** or **N** position
- you pull the cruise control lever towards you in order to pull away and the front-passenger door or one of the rear doors is open
- the vehicle is skidding
- you switch on Parking Pilot

If Distance Pilot DISTRONIC is automatically deactivated, you will hear a warning tone. The **Distance Pilot Off** message appears in the multifunction display for approximately five seconds.

Distance Pilot DISTRONIC is automatically deactivated if you activate DSR. The  DSR symbol appears in the multifunction display.

Distance Pilot DISTRONIC displays in the instrument cluster

Displays in the speedometer

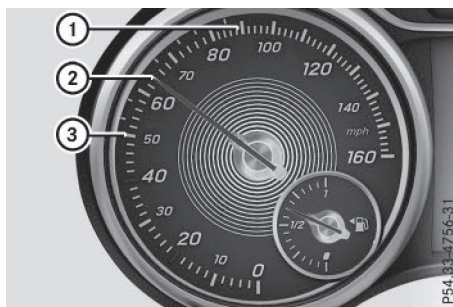

When Distance Pilot DISTRONIC is activated and there are no vehicles detected in front, one or two segments ② in the speed range set light up. If Distance Pilot DISTRONIC detects a vehicle in front, segments ② between speed of the vehicle in front ③ and stored speed ① light up.

- i** For design reasons, the speed displayed in the speedometer may differ slightly from the speed set for Distance Pilot DISTRONIC.

Display when Distance Pilot DISTRONIC is deactivated

In the Assistance menu (▷ page 182) of the on-board computer, you can select the assistance display.

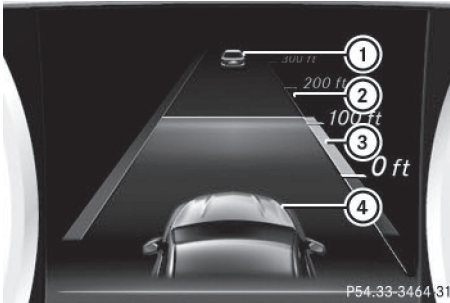

Assistance graphic

- ① Vehicle in front, if detected
 - ② Distance indicator, current distance to the vehicle in front
 - ③ Specified minimum distance to the vehicle in front; adjustable
 - ④ Own vehicle
- ▶ Select the **Assistance Graphic** function using the on-board computer (▷ page 182).

Display when Distance Pilot DISTRONIC is activated

You will initially see the stored speed for about five seconds when you activate Distance Pilot DISTRONIC.



Assistance graphic

- ① Vehicle in front, if detected
- ② Specified minimum distance to the vehicle in front; adjustable

- ③ Own vehicle
 - ④ Distance Pilot DISTRONIC active (text only appears when the cruise control lever is actuated)
- ▶ Select the **Assistance Graphic** function using the on-board computer (▷ page 182).

Tips for driving with Distance Pilot DISTRONIC

General notes

Pay particular attention in the following traffic situations:

- Cornering, entering and exiting a bend: the ability of Distance Pilot DISTRONIC to detect vehicles during cornering is limited. Your vehicle may brake unexpectedly or late.
 - Driving on a different line: Distance Pilot DISTRONIC may not detect vehicles which are not driving in the middle of their lane. The distance to the vehicle in front will be too short.
 - Other vehicles changing lanes: Distance Pilot DISTRONIC has not detected the vehicle cutting in yet. The distance to this vehicle will be too short.
 - Narrow vehicles: Distance Pilot DISTRONIC has not yet detected the vehicle in front on the edge of the road because of its narrow width. The distance to the vehicle in front will be too short.
 - Obstacles and stationary vehicles: Distance Pilot DISTRONIC does not brake for obstacles or stationary vehicles. If, for example, the detected vehicle turns a corner and an obstacle or stationary vehicle is then revealed, Distance Pilot DISTRONIC will not brake for them.
 - Distance Pilot DISTRONIC may mistakenly detect vehicles that are crossing your lane. If you activate Distance Pilot DISTRONIC in the following situations, the vehicle could pull away unintentionally:
 - At traffic lights with crossing traffic, for example.
 - With a vehicle ahead on the other side of an intersection and the HOLD function active.
- In such situations, brake if necessary. Distance Pilot DISTRONIC will then be deactivated.

HOLD function

General notes

The HOLD function can assist the driver in the following situations:

- when pulling away, especially on steep slopes
- when maneuvering on steep slopes
- when waiting in traffic

The vehicle is kept stationary without the driver having to depress the brake pedal.

The braking effect is canceled and the HOLD function deactivated when you depress the accelerator pedal to pull away.

Important safety notes

WARNING

When leaving the vehicle, it can still roll away despite being braked by the HOLD function if:

- there is a malfunction in the system or in the voltage supply.
- the HOLD function has been deactivated by pressing the accelerator pedal or the brake pedal, e.g. by a vehicle occupant.
- the electrical system in the engine compartment, the battery or the fuses have been tampered with.
- the battery is disconnected

There is a risk of an accident.

If you wish to exit the vehicle, always turn off the HOLD function and secure the vehicle against rolling away.

! When Distance Pilot DISTRONIC or the HOLD function is activated, the vehicle brakes automatically in certain situations. To avoid damage to the vehicle, deactivate Distance Pilot DISTRONIC and the HOLD function in the following or similar situations:

- when towing the vehicle
- in the car wash

Deactivating the HOLD function (> page 156).

Activation conditions

You can activate the HOLD function if:

- the vehicle is stationary
- the engine is running or if it has been automatically switched off by the ECO start/stop function
- the driver's door is closed or your seat belt is fastened
- the electric parking brake is released
- Distance Pilot DISTRONIC is deactivated
- the transmission position **D**, **R** or **N** is engaged while driving a vehicle with an automatic transmission

Activating the HOLD function



- ▶ Make sure that the activation conditions are met.
- ▶ Depress the brake pedal.
- ▶ Quickly depress the brake pedal further until ① appears in the multifunction display. The HOLD function is activated. You can release the brake pedal.

i If depressing the brake pedal the first time does not activate the HOLD function, wait briefly and then try again.

Deactivating the HOLD function

The HOLD function is deactivated automatically if:

- you accelerate. On vehicles with automatic transmission: only when the transmission is in position **D** or **R**.
- the transmission is in position **P** on vehicles with automatic transmission.
- you depress the brake pedal again with a certain amount of pressure until ① disappears from the multifunction display.
- you activate Distance Pilot DISTRONIC.
- you secure the vehicle using the electric parking brake.

- ▶ **i** After a time, the electric parking brake secures the vehicle and relieves the service brake.

When the HOLD function is activated, the transmission is shifted automatically to position **P** if:

- the driver's seat belt is not fastened and the driver's door is open.
- the engine is switched off, unless it is automatically switched off by the ECO start/stop function.

The electric parking brake secures the vehicle automatically if the HOLD function is activated when the vehicle is stationary and:

- a system malfunction occurs.
- the power supply is insufficient.

Start-off assist (except Mercedes-AMG vehicles)

Important safety notes

WARNING

If you use start-off assist, individual wheels may start to spin and the vehicle may skid. If ESP® is deactivated, there is a greater danger of skidding and having an accident. Make sure that no persons or obstacles are in the vicinity of the vehicle.

Start-off assist enables optimum acceleration from a standstill. For this, a suitably high-grip road surface is required, along with the tires and vehicle being in proper operating condition.

Do not activate start-off assist on public roads. Observe the safety notes on driving safety systems (▷ page 60).

Be sure to read the safety notes and information on ESP® (▷ page 63).

Activating start-off assist

- ▶ Deactivate ESP® (▷ page 182).
- ▶ Turn the steering wheel to the straight-ahead position.
- ▶ Depress the brake pedal hard with your left foot and keep it depressed.
- ▶ Shift the transmission to position **D**.
- ▶ Use the DYNAMIC SELECT button to select the **S** drive program (▷ page 127).

- ▶ Quickly depress the accelerator pedal fully.
- ▶ Take your foot off the brake, but keep the accelerator pedal depressed. The vehicle pulls away at maximum acceleration.

- ▶ **i** Activate ESP® as soon as the acceleration process has ended. ESP® will otherwise not be able to stabilize the vehicle if the vehicle starts to skid or a wheel starts to spin.

Canceling start-off assist

- ▶ Remove your foot from the accelerator pedal.
- ▶ Reactivate ESP®.

RACE START (Mercedes-AMG vehicles)

Important safety notes

- ▶ **i** RACE START must not be used on normal roads. RACE START must only be activated and used on dedicated road circuits, outside of public road use.

- ▶ **i** RACE START is only available in Mercedes-AMG vehicles.

WARNING

If you use RACE START, individual tires may start to spin and the vehicle could skid. Depending on the selected ESP® mode, there is an increased risk of skidding and having an accident. Make sure that no persons, animals or obstacles are within range of the vehicle.

RACE START enables optimal acceleration from a standing start. For this, a suitably high-grip road surface is required, along with the tires and vehicle being in proper operating condition.

- ▶ **i** Observe the safety notes on driving safety systems (▷ page 60).

Be sure to read the safety notes and information on ESP® (▷ page 63).

Conditions for activation

You can activate RACE START if:

- the doors, hood and the trunk lid are closed.
- the engine is running and the transmission, all-wheel drive clutch and the engine are at operating temperature.

- the steering wheel is in the straight-ahead position.
- the vehicle is stationary and the brake pedal is depressed (left foot).
- the transmission is in position **D**.
- one of the drive programs **S**, **S+** or **RACE** is selected. (▷ page 128)

Activating RACE START

- ▶ Depress the brake pedal with your left foot and keep it depressed.
- ▶ Pull and hold both steering wheel paddle shifters.
- ▶ The **RACE START Confirm: Paddle UP Cancel: Paddle DOWN** message appears in the multifunction display.
- ▶ Release both steering wheel paddle shifters.

i If the activation conditions are no longer fulfilled, RACE START is canceled. The **RACE START Not Possible See Operator's Manual** message appears in the multifunction display.

- ▶ **To cancel:** pull the left steering wheel paddle shifter (▷ page 135).

or

- ▶ **To confirm:** pull the right steering wheel paddle shifter (▷ page 135). The **RACE START Available Depress gas pedal** message appears in the multifunction display.

i If you do not depress the accelerator pedal within a few seconds, RACE START is canceled. The multifunction display shows the **RACE START Canceled** message.

- ▶ Fully depress the accelerator pedal. The engine speed is increased. The **RACE START Release brake to start** message appears in the multifunction display.

i If you do not release the brake pedal within a short time, RACE START will be canceled. The multifunction display shows the **RACE START Canceled** message.

- ▶ Take your foot off the brake, but keep the accelerator pedal depressed. The vehicle pulls away at maximum acceleration.

The **RACE START Active** message appears in the multifunction display.

RACE START is deactivated when the vehicle reaches a speed of approximately 50 km/h.

RACE START is deactivated immediately if you release the accelerator pedal during RACE START or if any of the activation conditions are no longer fulfilled. The **RACE START Not Possible** or **RACE START Canceled** message appears in the multifunction display.

i If RACE START is used repeatedly within a short period of time, it is only available again after the vehicle has been driven a certain distance.

AMG adaptive sport suspension system

General notes

The electronically controlled damping system works continuously. This improves driving safety and ride comfort.

The damping is tuned individually to each wheel and depends on:

- your driving style, e.g. sporty
- the road surface condition, e.g. bumps
- your individual selection of "Sport" or "Comfort"

The suspension setting is adjusted using the corresponding button in the center console.

i The mode can also be set using the AMG DYNAMIC SELECT controller (▷ page 128).

Each time you start the engine with the Smart-Key or the Start/Stop button, Comfort mode is activated. For further information about starting the engine, see (▷ page 122).

Sport mode

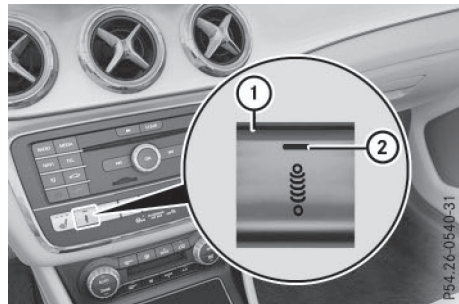

The firmer setting of the suspension tuning in Sport mode ensures even better contact with the road. Select this mode when employing a sporty driving style, e.g. on winding country roads.

- ▶ Press button ①.
Indicator lamp ② lights up. You have selected Sport mode.

The **AMG Suspension System SPORT** message appears in the multifunction display.

Comfort mode

In Comfort mode, the driving characteristics of your vehicle are more comfortable. Select this mode if you favor a more comfortable driving style, but also when driving fast on straight roads, e.g. highways.

- ▶ Press button ① again so that indicator lamp ② goes out.
You have selected Comfort mode.

The **AMG Suspension System COMFORT** message appears in the multifunction display.

4MATIC

- ⚠ Never tow the vehicle with one axle raised. This may damage the differential. Damage of this sort is not covered by the Mercedes-Benz Limited Warranty. All wheels must remain either on the ground or be fully raised. Observe the instructions for towing the vehicle with all wheels in full contact with the ground.

4MATIC, together with ESP®, improves the traction of your vehicle whenever a drive wheel spins due to insufficient grip.

If you fail to adapt your driving style, 4MATIC can neither reduce the risk of accident nor override the laws of physics. 4MATIC cannot take account of road, weather and traffic conditions. 4MATIC is only an aid. You are responsible for the distance to the vehicle in front, for vehicle speed, for braking in good time and for staying in your lane.

If a drive wheel spins due to insufficient grip:

- Only depress the accelerator pedal as far as necessary when pulling away.
- Accelerate less when driving.

- i In wintry driving conditions, the maximum effect of 4MATIC can only be achieved if you use winter tires (M+S tires), with snow chains if necessary.

Suspension with Adaptive Damping System

General notes

A suspension with the Adaptive Damping System provides improved driving comfort and continuously controls the calibration of the dampers. The damping characteristics adapt to the current operating and driving situation.

The damping is tuned individually to each wheel and depends on:

- your driving style, e.g. sporty
- the road surface conditions
- the drive program selected

The drive program can be set using the DYNAMIC SELECT button (▷ page 127).

Selecting Comfort mode

In the **Comfort** drive program, the driving characteristics of your vehicle are more comfortable. Therefore, select this drive program if you prefer a more comfortable driving style. Also select the **Comfort** drive program when driving fast on straight roads, e.g. on straight stretches of highway.

- ▶ Press DYNAMIC SELECT button (▷ page 127) as many times as necessary until the **Comfort** drive program is selected.

Selecting Sport mode

The firmer setting of the suspension tuning in the **Sport** drive program ensures even better contact with the road. Select this drive program when employing a sporty driving style, e.g. on winding country roads.

- ▶ Press DYNAMIC SELECT button (▷ page 127) as many times as necessary until the **Sport** drive program is selected.

Parking Assist PARKTRONIC

Important safety notes

Parking Assist PARKTRONIC is an electronic parking aid with ultrasound. It monitors the area around your vehicle using six sensors in the front bumper and six sensors in the rear bumper. Parking Assist PARKTRONIC visually and audibly indicates the distance between your vehicle and an object.

Parking Assist PARKTRONIC is only an aid. It is not a replacement for your attention to your immediate surroundings. You are always responsible for safe maneuvering, parking and exiting a parking space. When maneuvering, parking or pulling out of a parking space, make sure that there are no persons, animals or objects in the area in which you are maneuvering.

! When parking, pay particular attention to objects above or below the sensors, such as flower pots or trailer drawbars. Parking Assist PARKTRONIC does not detect such objects when they are in the immediate vicinity of the vehicle. You could damage the vehicle or the objects.

The sensors may not detect snow and other objects that absorb ultrasonic waves.

Ultrasonic sources such as an automatic car wash, the compressed-air brakes of a truck or a pneumatic drill could cause Parking Assist PARKTRONIC to malfunction.

Parking Assist PARKTRONIC may not function correctly on uneven terrain.

Parking Assist PARKTRONIC is activated automatically when you:

- switch on the ignition
- shift the transmission to position **D**, **R** or **N**
- release the electric parking brake

Parking Assist PARKTRONIC is deactivated at speeds above 11 mph (18 km/h). It is reactivated at lower speeds.

Range of the sensors

General notes

Parking Assist PARKTRONIC does not take into account obstacles located:

- below the detection range, e.g. people, animals or objects.
- above the detection range, e.g. overhanging loads, tail sections or loading ramps of goods vehicles.



① Sensors in the front bumper, left-hand side (example)

The sensors must be free from dirt, ice or slush. They can otherwise not function correctly. Clean the sensors regularly, taking care not to scratch or damage them (> page 262).

Range

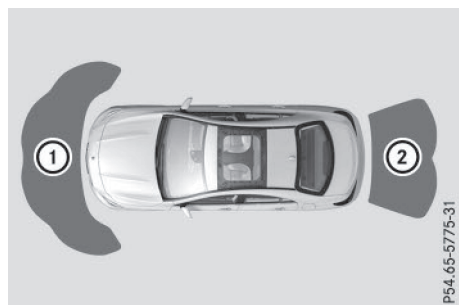

- ① Detection range of front sensors
- ② Detection range of rear sensors

Front sensors

Center	Approx. 40 in (approx. 100 cm)
Corners	Approx. 24 in (approx. 60 cm)

Rear sensors

Center	Approx. 48 in (approx. 120 cm)
Corners	Approx. 32 in (approx. 80 cm)

Minimum distance

Center	Approx. 8 in (approx. 20 cm)
Corners	Approx. 6 in (approx. 15 cm)

If there is an obstacle within this range, the relevant warning displays light up and a warning tone sounds. If the distance falls below the minimum, the distance may no longer be shown.

Warning displays

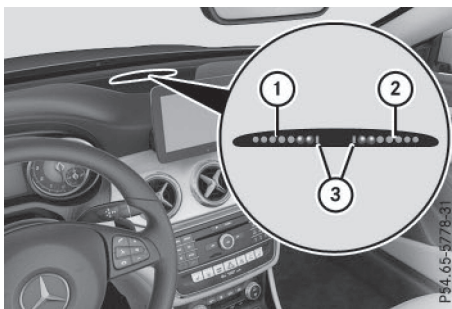

- ① Segments on the left-hand side of the vehicle
- ② Segments on the right-hand side of the vehicle
- ③ Segments showing operational readiness

The warning displays show the distance between the sensors and the obstacle. The warning display for the front area is located on the dashboard above the center air vents. The warning display for the rear area is located on the headliner in the rear compartment.

The warning display for each side of the vehicle is divided into five yellow and two red segments.

Parking Assist PARKTRONIC is operational if yellow segments showing operational readiness ③ light up.

The gear lever position or the transmission position of the automatic transmission and the direction in which the vehicle is rolling determine which warning display is active when the engine is running.

Transmission position	Warning display
D	Front area activated
R, N or the vehicle is rolling backwards	Rear and front areas activated
P	No areas activated

One or more segments light up as the vehicle approaches an obstacle, depending on the vehicle's distance from the obstacle.

From the:

- sixth segment onwards, you will hear an intermittent warning tone for approximately two seconds.
- seventh segment onwards, you will hear a warning tone for approximately two seconds. This indicates that you have now reached the minimum distance.

Deactivating or activating Parking Assist PARKTRONIC



- ① Indicator lamp
- ② Deactivates or activates Parking Assist PARKTRONIC

If indicator lamp ① is lit, Parking Assist PARKTRONIC is deactivated.

- i** Parking Assist PARKTRONIC is automatically activated when you turn the SmartKey to position **2** in the ignition lock.

Problems with Parking Assist PARKTRONIC

Problem	Possible causes/consequences and ► Solutions
<p>Only the red segments in the Parking Assist PARKTRONIC warning displays are lit. You also hear a warning tone for approximately two seconds.</p> <p>Parking Assist PARKTRONIC is then deactivated and the indicator lamp on the PARKTRONIC button lights up.</p>	<p>Parking Assist PARKTRONIC has malfunctioned and has been deactivated.</p> <p>► If problems persist, have Parking Assist PARKTRONIC checked at a qualified specialist workshop.</p>
<p>Only the red segments in the Parking Assist PARKTRONIC warning displays are lit. Parking Assist PARKTRONIC is then deactivated.</p>	<p>The Parking Assist PARKTRONIC sensors are dirty or there is interference.</p> <p>► Clean the Parking Assist PARKTRONIC sensors (► page 262).</p> <p>► Switch the ignition back on.</p> <p>The problem may be caused by an external source of radio or ultrasound waves.</p> <p>► Check to see if Parking Assist PARKTRONIC works at a different location.</p>

Parking Pilot

General notes

Parking Pilot is an electronic parking aid with ultrasound. It measures the road on both sides of the vehicle. A parking symbol indicates a suitable parking space. Active steering intervention and brake application can assist you during parking and when exiting a parking space. Parking Assist PARKTRONIC is also available (► page 160).

Important safety notes

Parking Pilot is only an aid. It is not a replacement for your attention to your immediate surroundings. You are always responsible for safe maneuvering, parking and exiting a parking space. Make sure that no persons, animals or objects are in the maneuvering range.

When Parking Assist PARKTRONIC is deactivated, Parking Pilot is also unavailable.

WARNING

While parking or pulling out of a parking space, the vehicle swings out and can drive onto areas of the oncoming lane. This could result in a collision with another road user. There is a risk of an accident.

Pay attention to other road users. Stop the vehicle if necessary or cancel the Parking Pilot parking procedure.

- !** If unavoidable, you should drive over obstacles such as curbs slowly and not at a sharp angle. Otherwise, you may damage the wheels or tires.

Parking Pilot may also display spaces not suitable for parking, e.g.:

- where parking or stopping is prohibited
- in front of driveways or entrances and exits
- on unsuitable surfaces

Parking tips:

- On narrow roads, drive as close to the parking space as possible.
- Parking spaces that are littered or overgrown might be identified or measured incorrectly.
- Parking spaces that are partially occupied by trailer drawbars might not be identified as such or be measured incorrectly.
- Snowfall or heavy rain may lead to a parking space being measured inaccurately.
- Pay attention to the warning messages of Parking Pilot PARKTRONIC during the parking procedure (▷ page 161).
- You can intervene to correct the steering procedure at any time. Parking Pilot will then be canceled.
- When transporting a load that protrudes from your vehicle, you must not use Parking Pilot.
- Never use Parking Pilot when snow chains are mounted.
- Make sure that the tire pressures are always correct. This has a direct influence on the parking characteristics of the vehicle.

Use Parking Pilot for parking spaces that are:

- that are parallel or at right-angles to the direction of travel
- on straight roads, not bends
- on the same level as the road, e.g. not on the pavement

Detecting parking spaces

Objects located above the detection range of Parking Pilot will not be detected when the parking space is measured. These are not taken into account when the parking procedure is calculated, e.g. overhanging loads, truck overhangs or loading ramps.

WARNING

If there are objects above the detection range:

- Parking Pilot may steer in too early
- the vehicle may not stop in front of these objects

You may cause a collision as a result. There is a risk of an accident.

If objects are located above the detection range, stop and deactivate Parking Pilot.

For further information on the detection range (▷ page 160).

Parking Pilot does not assist you parking in spaces perpendicular to the direction of travel if:

- two parking spaces are located directly next to one another
- the parking space is directly next to a low obstacle such as a low curb
- you forward-park

Parking Pilot does not assist you parking in spaces parallel or perpendicular to the direction of travel if:

- the parking space is on a curb
- the system reads the parking space as being blocked, for example by foliage or grass paving blocks
- the area is too small for the vehicle to maneuver into
- the parking space is bordered by an obstacle, e.g. a tree, a post or a trailer

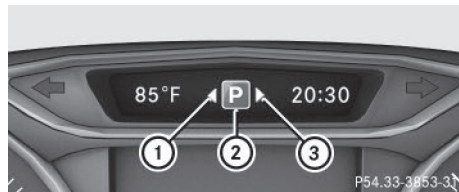

- ① Detected parking space on the left
- ② Parking symbol
- ③ Detected parking space on the right

Parking Pilot is activated automatically when driving forwards. The system is operational at speeds of up to approximately 22 mph (35 km/h). While in operation, the system independently locates and measures parking spaces on both sides of the vehicle.

Parking Pilot will only detect parking spaces:

- that are parallel or at right-angles to the direction of travel
- that are parallel to the direction of travel and at least 59 in (1.5 m) wide

- that are parallel to the direction of travel and at least 39.5 in (1.0 m) longer than your vehicle
- that are at right angles to the direction of travel and at least 39.5 in (1.0 m) wider than your vehicle

i Note that Parking Pilot cannot measure the length of a parking space if it is at right angles to the direction of travel. You will need to judge whether your vehicle will fit into the parking space.

When driving at speeds below 19 mph (30 km/h), you will see parking symbol ② as a status indicator in the instrument cluster. When a parking space has been detected, an arrow towards the right or the left also appears. Parking Pilot only displays parking spaces on the front-passenger side as standard. Parking spaces on the driver's side are displayed as soon as the turn signal on the driver's side is activated. When parking on the driver's side, this must remain activated until you confirm the use of Parking Pilot by pressing the **OK** button on the multifunction steering wheel. The system automatically determines whether the parking space is parallel or at right-angles to the direction of travel.

A parking space is displayed while you are driving past it, and until you are approximately 50 ft (15 m) away from it.

Parking

WARNING

If you leave the vehicle when it is only being braked by Parking Pilot, it could roll away if:



- there is a malfunction in the system or in the voltage supply.
- the electrical system in the engine compartment, the battery or the fuses are tampered with.
- the battery is disconnected.
- the vehicle is accelerated, e.g. by a vehicle occupant.

There is a risk of an accident.

Before leaving the vehicle, always secure it against rolling away.

i If Parking Assist PARKTRONIC detects obstacles, Parking Pilot brakes automatically

whilst the vehicle is parking. You are responsible for braking in good time.

- ▶ Stop the vehicle when the parking space symbol shows the desired parking space in the instrument cluster.
- ▶ Shift the transmission to position **R**. The **Start Parking Pilot? Yes: OK No:**  message appears in the multifunction display.
- ▶ **To cancel the procedure:** press the  button on the multifunction steering wheel or pull away.

or

- ▶ **To park using Parking Pilot:** press the **OK** button on the multifunction steering wheel. The **Parking Pilot Active Accelerate and Brake Observe Surroundings** message appears in the multifunction display.
- ▶ Let go of the multifunction steering wheel.
- ▶ Back up the vehicle, being ready to brake at all times. When backing up, drive at a speed below approximately 6 mph (10 km/h). Otherwise Parking Pilot is canceled. Parking Pilot brakes the vehicle to a standstill when the vehicle approaches the rear border of the parking space. Maneuvering may be required in tight parking spaces.

The **Parking Pilot Active Select D Observe Surroundings** message appears in the multifunction display.

- ▶ Shift the transmission to position **D** while the vehicle is stationary. Parking Pilot immediately steers in the other direction.

The **Parking Pilot Active Accelerate and Brake Observe Surroundings** message appears in the multifunction display.

- i** You will achieve the best results by waiting for the steering procedure to complete before pulling away.
- ▶ Drive forwards and be ready to brake at all times. Parking Pilot brakes the vehicle to a standstill when the vehicle approaches the front border of the parking space. Maneuvering may be required in tight parking spaces.

The **Parking Pilot Active Select R Observe Surroundings** message appears in the multifunction display.

As soon as the parking procedure is complete, the **Parking Pilot Ended** message appears in the multifunction display and a warning tone sounds. The vehicle is now parked.

The vehicle is kept stationary without the driver having to depress the brake pedal. The braking effect is canceled when you depress the accelerator pedal.

Parking Pilot no longer supports you with steering interventions and brake applications. When Parking Pilot is ended, you must steer and brake again yourself. Parking Assist PARKTRONIC is still available.

Parking tips:

- The way your vehicle is positioned in the parking space after parking is dependent on various factors. These include the position and shape of the vehicles parked in front and behind it and the conditions of the location. It may be the case that Parking Pilot guides you too far into a parking space, or not far enough into it. In some cases, it may also lead you across or onto the curb. If necessary, you should abort the parking procedure with Parking Pilot.
- You can also select preselect transmission position **D**. The vehicle redirects and does not drive as far into the parking space. Should the transmission change take place too early, the parking procedure will be canceled. A sensible parking position can no longer be achieved from this position.



Exiting a parking space

In order for Parking Pilot to support you when exiting the parking space:

- you need to have parked using Parking Pilot.
- the border of the parking space must be high enough at the front and the rear. A curb stone is too small, for example.
- the border of the parking space must not be too wide, as the position of the vehicle must not exceed an angle of 45° to the starting position as it is maneuvered into the parking space.
- a maneuvering distance of at least 3.3 ft (1.0 m) must be available.

Parking Pilot can assist you with exiting a parking space only if you have parked the vehicle parallel to the direction of travel using Parking Pilot.

i If Parking Assist PARKTRONIC detects obstacles, Parking Pilot brakes automatically whilst the vehicle is exiting the parking space. You are responsible for braking in good time.

- ▶ Start the engine.
- ▶ Release the electric parking brake.
- ▶ Switch on the turn signal in the direction you will drive out of the parking space.
- ▶ Shift the transmission to position **D** or **R**. The **Start Parking Pilot? Yes: OK No:**  message appears in the multifunction display.
- ▶ **To cancel the procedure:** press the  button on the multifunction steering wheel or pull away.

or

- ▶ **To exit a parking space using Parking Pilot:** press the  button on the multifunction steering wheel. The **Parking Pilot Active Accelerate and Brake Observe Surroundings** message appears in the multifunction display.
- ▶ Let go of the multifunction steering wheel.
- ▶ Pull away, being ready to brake at all times. Do not exceed a maximum speed of approximately 6 mph (10 km/h) when exiting a parking space. Otherwise, Parking Pilot is canceled immediately.
- ▶ Depending on the message or as required, shift the transmission to position **D** or **R**. Parking Pilot immediately steers in the other direction. The **Parking Pilot Active Accelerate and Brake Observe Surroundings** message appears in the multifunction display.

i You will achieve the best results by waiting for the steering procedure to complete before pulling away.

If you back up after activation, the steering wheel is moved to the straight-ahead position.

- ▶ Drive forwards and reverse as prompted by the Parking Assist PARKTRONIC warning displays, several times if necessary.

Once you have exited the parking space completely, the steering wheel is moved to the straight-ahead position. You hear a tone and the **Parking Pilot Finished** message appears in the multifunction display. You will then have to steer and merge into traffic on your own. Parking Assist PARKTRONIC is still available. You can

take over the steering before the vehicle has exited the parking space completely. This is useful, for example when you recognize that it is already possible to pull out of the parking space.

Canceling Parking Pilot

- ▶ Stop the movement of the multifunction steering wheel or steer yourself. Parking Pilot is canceled immediately. The **Parking Pilot Canceled** message appears in the multifunction display.

or

- ▶ Press the PARKTRONIC button (▷ page 161). Parking Assist PARKTRONIC is switched off and Parking Pilot is immediately canceled. The **Parking Pilot Canceled** message appears in the multifunction display.

Parking Pilot is canceled automatically when:

- the electric parking brake is engaged
- transmission position **P** is selected
- parking using Parking Pilot is no longer possible
- you are driving faster than 6 mph (10 km/h)
- a wheel spins, ESP[®] intervenes or fails. In such cases the  warning lamp lights up in the instrument cluster

A warning tone sounds. The parking symbol disappears and the multifunction display shows the **Parking Pilot Canceled** message.

When Parking Pilot is canceled, you must steer and brake again yourself.

If a system malfunction occurs, the vehicle is braked to a standstill. To drive on, depress the accelerator again.

Rear view camera

General notes

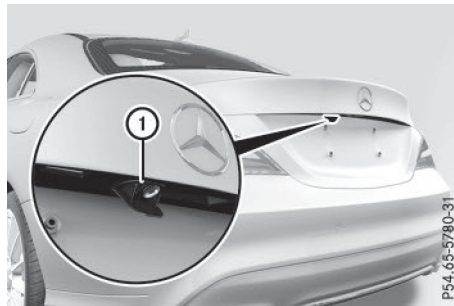

Rear view camera ① is an optical parking and maneuvering aid. It shows the area behind your vehicle with guide lines in the multimedia system display.

The area behind the vehicle is displayed as a mirror image, as in the rear view mirror.

- ❗ The text shown in the multimedia system display depends on the language setting. The following are examples of rear view camera messages in the multimedia system display.

Observe the notes on cleaning (▷ page 262).

Important safety notes

The rear view camera is only an aid. It is not a replacement for your attention to your immediate surroundings. You are always responsible for safe maneuvering and parking. When maneuvering or parking, make sure that there are no persons, animals or objects in the area in which you are maneuvering.

Under the following circumstances, the rear view camera will not function, or will function in a limited manner:

- if the trunk lid is open
- in heavy rain, snow or fog
- at night or in very dark places
- if the camera is exposed to very bright light
- if the area is lit by fluorescent bulbs or LED lighting (the display may flicker)
- if there is a sudden change in temperature, e.g. when driving into a heated garage in winter

- if the camera lens is dirty or obstructed
Observe the notes on cleaning
(▷ page 262)
- if the rear of your vehicle is damaged. In this case, have the camera position and setting checked at a qualified specialist workshop

The field of vision and other functions of the rear view camera may be restricted due to additional accessories on the rear of the vehicle (e.g. license plate holder, bicycle rack).

Activating/deactivating the rear view camera

- ▶ **To activate:** make sure that the SmartKey is in position **2** in the ignition lock.
- ▶ Make sure that the **Activation by R gear** function is selected in the multimedia system; see the Digital Operator's Manual.
- ▶ Engage reverse gear.
The area behind the vehicle is shown with guide lines in the multimedia system display. The image from the rear view camera is available throughout the maneuvering process.

To deactivate: the rear view camera deactivates if you shift the transmission to **P** or after driving forwards a short distance.

Messages in the multimedia system display

The rear view camera may show a distorted view of obstacles, show them incorrectly or not at all. The rear view camera does not show objects in the following positions:

- very close to the rear bumper
- under the rear bumper
- in close range above the handle on the trunk lid

! Objects not at ground level may appear to be further away than they actually are, e.g.:

- the bumper of a parked vehicle
- the drawbar of a trailer
- the ball coupling of a trailer tow hitch
- the rear section of an HGV
- a slanted post

Use the guidelines only for orientation.

Approach objects no further than the bottom-most guideline.

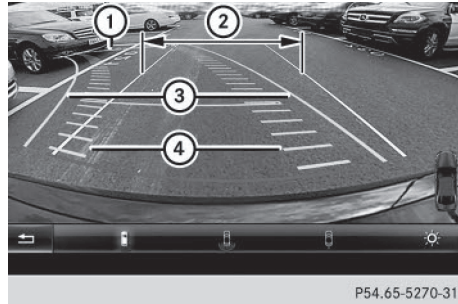

- ① Yellow guide line at a distance of approximately 13 ft (4.0 m) from the rear of the vehicle
- ② White guide line without turning the steering wheel, vehicle width including the exterior mirrors (static)
- ③ Yellow guide line for the vehicle width including the exterior mirrors, for current steering wheel angle (dynamic)
- ④ Yellow lane marking of the tires at current steering wheel angle (dynamic)

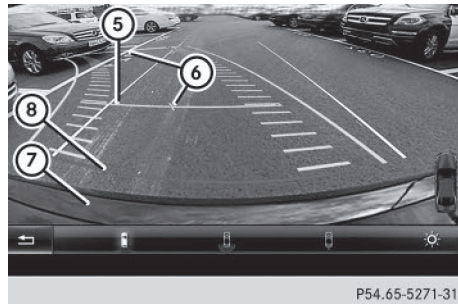

- ⑤ Yellow guide line at a distance of approximately 3 ft (1.0 m) from the rear of the vehicle
- ⑥ Vehicle center axle (marker assistance)
- ⑦ Bumper
- ⑧ Red guide line at a distance of approximately 12 in (0.30 m) from the rear of the vehicle



- ① Front warning display
- ② Additional measurement operational readiness indicator for Parking Assist PARKTRONIC
- ③ Rear warning display

When Parking Assist PARKTRONIC is operational (▷ page 161), additional measurement operational readiness indicator ② appears in the multimedia system display. If the Parking Assist PARKTRONIC warning displays are active or light up, warning displays ① and ③ are also active or light up correspondingly in the multimedia system display.

"Reverse parking" function

Backing up straight into a parking space without turning the steering wheel

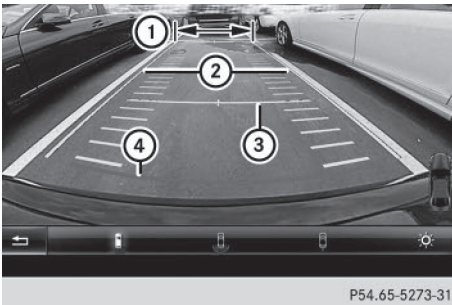

- ① White guide line without turning the steering wheel, vehicle width including the exterior mirrors (static)
- ② Yellow guide line for the vehicle width including the exterior mirrors, for current steering wheel angle (dynamic)

- ③ Yellow guide line at a distance of approximately 3 ft (1.0 m) from the rear of the vehicle

- ④ Red guide line at a distance of approximately 12 in (0.30 m) from the rear of the vehicle

- ▶ Make sure that the rear view camera is switched on (▷ page 167). The lane and the guide lines are shown.
- ▶ With the help of white guide line ①, check whether the vehicle will fit into the parking space.
- ▶ Using white guide line ① as a guide, carefully back up until you reach the end position. Red guide line ④ is then at the end of the parking space. The vehicle is almost parallel in the parking space.

Reverse perpendicular parking with the steering wheel at an angle

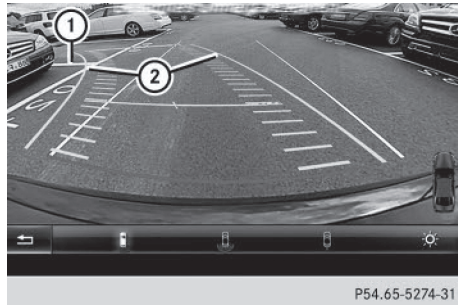

- ① Parking space marking
- ② Yellow guide line for the vehicle width including the exterior mirrors, for current steering wheel angle (dynamic)

- ▶ Drive past the parking space and bring the vehicle to a standstill.
- ▶ Make sure that the rear view camera is switched on (▷ page 167). The lane and the guide lines are shown.
- ▶ While the vehicle is at a standstill, turn the steering wheel in the direction of the parking space until yellow guide line ② reaches parking space marking ①.
- ▶ Keep the steering wheel in that position and back up carefully.

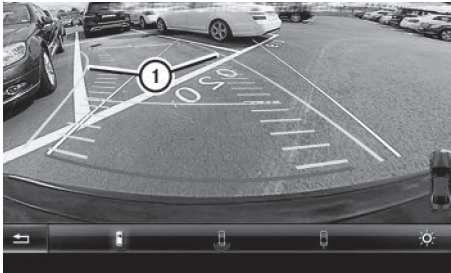

P54.65-5275-31

- ① Yellow guide line for the vehicle width including the exterior mirrors, for current steering wheel angle (dynamic)
- ▶ Stop the vehicle when it is almost exactly in front of the parking space. The white lane should be as close to parallel with the parking space marking as possible.

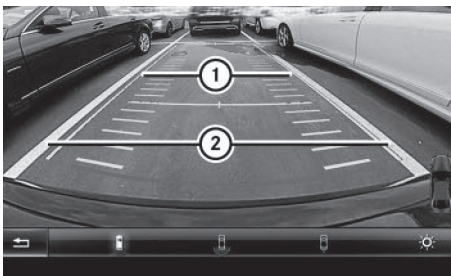

P54.65-5276-31

- ① White guide line at current steering wheel angle
- ② Parking space marking
- ▶ Turn the steering wheel to the center position while the vehicle is stationary.

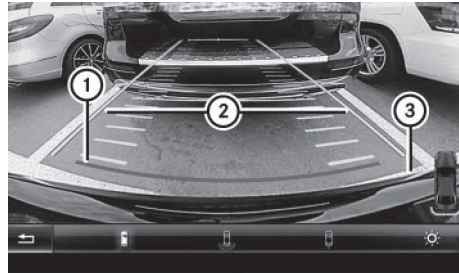

P54.65-5277-31

- ① Red guide line at a distance of approximately 12 in (0.30 m) from the rear of the vehicle
- ② White guide line without turning the steering wheel
- ③ End of parking space
- ▶ Back up carefully until you have reached the final position. Red guide line ① is then at end of parking space ③. The vehicle is almost parallel in the parking space.

Wide-angle function

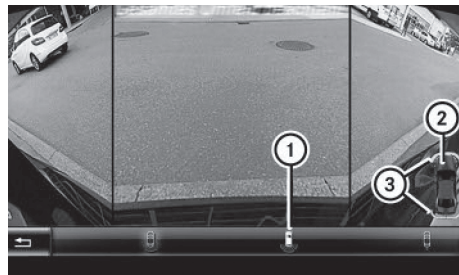

P54.65-4902-31

- ① Symbol for the wide-angle view function
- ② Own vehicle
- ③ Parking Assist PARKTRONIC warning displays

Select this view when you are driving out of an exit and the view of crossing traffic is restricted, for example.

ATTENTION ASSIST

General notes

ATTENTION ASSIST helps you during long, monotonous journeys, such as on highways. It is active in the 37 mph (60 km/h) to 125 mph

(200 km/h) range. If ATTENTION ASSIST detects typical indicators of fatigue or increasing lapses in concentration on the part of the driver, it suggests taking a break.

Important safety notes

ATTENTION ASSIST is only an aid to the driver. It might not always recognize fatigue or increasing inattentiveness in time or fail to recognize them at all. The system is not a substitute for a well-rested and attentive driver.

The functionality of ATTENTION ASSIST is restricted and warnings may be delayed or not occur at all:

- if the length of the journey is less than approximately 30 minutes
- if the road condition is poor, e.g. if the surface is uneven or if there are potholes
- if there is a strong side wind
- if you have adopted a sporty driving style with high cornering speeds or high rates of acceleration
- if you are predominantly driving slower than 37 mph (60 km/h) or faster than 125 mph (200 km/h)
- if the time has been set incorrectly
- in active driving situations, such as when you change lanes or change your speed

ATTENTION ASSIST is reset when you continue your journey and starts assessing your tiredness again if:

- you switch off the engine
- you take off your seat belt and open the driver's door, e.g. for a change of drivers or to take a break

Displaying the attention level



You can have current status information displayed in the assistance menu (▷ page 182) of the on-board computer.

- ▶ Select the Assistance display for Attention Assist using the on-board computer (▷ page 182).

The following information is displayed:

- Length of the journey since the last break.
- The **Attention Level** determined by ATTENTION ASSIST, displayed in a bar display in five levels from high to low
- If ATTENTION ASSIST is unable to calculate the attention level and cannot output a warning, the **System Passive** message appears. The bar display then changes the display, such as when you are driving at a speed below 37 mph (60 km/h) or above 124 mph (200 km/h).

Activating ATTENTION ASSIST

- ▶ Activate ATTENTION ASSIST using the on-board computer (▷ page 183). The system determines the attention level of the driver depending on the setting selected:

Standard selected: the sensitivity with which the system determines the attention level is set to normal.

Sensitive selected: the sensitivity is set higher. The attention level detected by Attention Assist is adapted accordingly and the driver is warned earlier.

When ATTENTION ASSIST is deactivated, the  symbol appears in the multifunction display in the assistance graphic display.

When ATTENTION ASSIST has been deactivated, it is automatically reactivated after the engine has been stopped. The sensitivity selected corresponds to the last selection activated (standard/sensitive).

Warning in the multifunction display

If fatigue or increasing lapses in concentration are detected, a warning appears in the multifunction display: **ATTENTION ASSIST Take a Break!**

In addition to the message shown in the multifunction display, you will then hear a warning tone.

- ▶ If necessary, take a break.
- ▶ Confirm the message by pressing the  button on the steering wheel.

On long journeys, take regular breaks in good time to allow yourself to rest properly. If you do not take a break and ATTENTION ASSIST still detects increasing lapses in concentration, you will be warned again after 15 minutes at the earliest. This will only happen if ATTENTION ASSIST still detects typical indicators of fatigue or increasing lapses in concentration.

Vehicles with the COMAND multimedia system: if a warning is output in the multifunction display, a service station search is performed in the multimedia system. You can select a service station and navigation to this service station will then begin. This function can be activated or deactivated in the multimedia system; see the Digital Operator's Manual.

Lane Tracking package

General notes

The Lane Tracking package consists of Blind Spot Assist (▶ page 171) and Lane Keeping Assist (▶ page 172).

Blind Spot Assist

General notes

Blind Spot Assist monitors the areas on either side of the vehicle that are not visible to the driver with two lateral, rear-facing radar sensors. A warning display in the exterior mirrors draws your attention to vehicles detected in the monitored area. If you then switch on the corresponding turn signal to change lane, you will also receive an optical and audible warning.

Blind Spot Assist supports you from a speed of approximately 20 mph (30 km/h).

Important safety notes

WARNING

Blind Spot Assist does not react to:

- vehicles overtaken too closely on the side, placing them in the blind spot area
- vehicles which approach with a large speed differential and overtake your vehicle

As a result, Blind Spot Assist may not give warnings in such situations. There is a risk of an accident.

Always observe the traffic conditions carefully, and maintain a safe lateral distance.

Blind Spot Assist is only an aid. It may fail to detect some vehicles and is no substitute for attentive driving. Always ensure that there is sufficient distance to the side for other road users and obstacles.

USA only:

This device has been approved by the FCC as a "Vehicular Radar System". The radar sensor is intended for use in an automotive radar system only. Removing, tampering with, or altering the device will void any warranties, and is not permitted by the FCC. Do not tamper with, alter, or use in any non-approved way.

Any unauthorized modification to this device could void the user's authority to operate the equipment.

Radar sensors

The radar sensors for Blind Spot Assist are integrated into the rear bumper. Make sure that the bumpers are free from dirt, ice or slush. The sensors must not be covered, for example by cycle racks or overhanging loads. Following a severe impact or in the event of damage to the bumpers, have the function of the radar sensors checked at a qualified specialist workshop. Blind Spot Assist may no longer work properly.

Monitoring range of the sensors

In particular, the detection of obstacles can be impaired if:

- there is dirt on the sensors or anything else covering the sensors
- there is poor visibility, e.g. due to fog, heavy rain or snow
- a narrow vehicle traveling in front, e.g. a motorbike or bicycle
- the road has very wide lanes
- the road has narrow lanes
- you are not driving in the middle of the lane
- there are barriers or other road boundaries

Vehicles in the monitoring range are then not indicated.

Blind Spot Assist monitors the area up to 10 ft (3 m) behind your vehicle and directly next to it. If the lanes are narrow, vehicles driving in the lane beyond the lane next to your vehicle may be indicated, especially if the vehicles are not driving in the middle of their lane. This may be the case if the vehicles are driving on the inner side of their lane.

Due to the nature of the system:

- warnings may be issued in error when driving close to crash barriers or similar solid lane borders.
- warnings may be interrupted when driving alongside particularly long vehicles, e.g. trucks, for a prolonged time.

Warning display

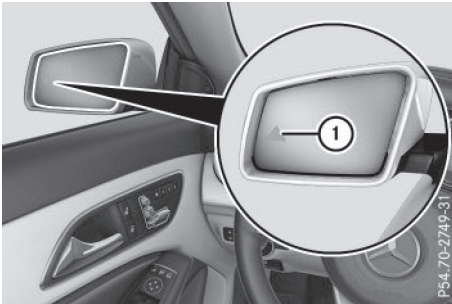

① Warning display

Blind Spot Assist is not active at speeds below approximately 20 mph (30 km/h). Vehicles in the monitoring range are then not indicated.

When Blind Spot Assist is activated, indicator lamp ① in the exterior mirrors lights up yellow at speeds of up to 20 mph (30 km/h). At speeds above 20 mph (30 km/h), the indicator lamp goes out and Blind Spot Assist is operational.

If a vehicle is detected within the blind spot monitoring range at speeds above 20 mph (30 km/h), warning lamp ① on the corresponding side lights up red. This warning is always emitted when a vehicle enters the blind spot monitoring range from behind or from the side. When you overtake a vehicle, the warning only occurs if the difference in speed is less than 7 mph (12 km/h).

The yellow indicator lamp goes out if reverse gear is engaged. In this event, Blind Spot Assist is no longer active.

The brightness of the indicator/warning lamps is adjusted automatically according to the ambient light.

Collision warning

If a vehicle is detected in the monitoring range of Blind Spot Assist and you switch on the corresponding turn signal, a double warning tone sounds. Red warning lamp ① flashes. If the turn signal remains on, vehicles detected are indicated by the flashing of red warning lamp ①. There are no further warning tones.

Switching on Blind Spot Assist

- ▶ Make sure that Blind Spot Assist is activated in the on-board computer (▷ page 183).
- ▶ Turn the SmartKey to position **2** in the ignition lock.

Warning lamps ① in the exterior mirrors light up red for approximately 1.5 seconds and then turn yellow.

Lane Keeping Assist

General notes

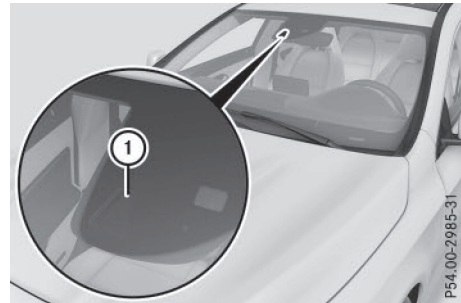

Lane Keeping Assist monitors the area in front of your vehicle by means of multifunction camera ① which is attached behind the top of the windshield. Active Lane Keeping Assist detects lane markings on the road and can warn you before you leave your lane unintentionally.

This function is available in the range between 40 mph and 120 mph (60 km/h and 200 km/h). A warning may be given if a front wheel passes over a lane marking. It will warn you by means of intermittent vibration in the steering wheel for up to 1.5 seconds.

Important safety notes**⚠ WARNING**

Lane Keeping Assist may not always clearly recognize lane markings.

In this case, Lane Keeping Assist may:

- give an unnecessary warning
- not give a warning

There is a risk of an accident.

Always pay particular attention to the traffic situation and stay in lane, in particular if warned by Lane Keeping Assist.

⚠ WARNING

The Lane Keeping Assist warning does not return the vehicle to the original lane. There is a risk of an accident.

You should always steer, brake or accelerate yourself, in particular if warned by Lane Keeping Assist.

If you fail to adapt your driving style, Lane Keeping Assist can neither reduce the risk of an accident nor override the laws of physics. Lane Keeping Assist cannot take into account the road, traffic and weather conditions. Lane Keeping Assist is merely an aid. You are responsible for the distance to the vehicle in front, for vehicle speed, for braking in good time and for staying in your lane.

The Lane Keeping Assist does not keep the vehicle in the lane.

The system may be impaired or may not function if:

- there is poor visibility, e.g. due to insufficient illumination of the road, or due to snow, rain, fog or spray
- there is glare, e.g. from oncoming traffic, the sun or reflection from other vehicles (e.g. if the road surface is wet)
- the windshield is dirty, fogged up, damaged or covered, for instance by a sticker, in the vicinity of the camera
- there are no, several or unclear lane markings for a lane, e.g. in areas with road construction work
- the lane markings are worn away, dark or covered up, e.g. by dirt or snow

- the distance to the vehicle in front is too small and the lane markings thus cannot be detected
- the lane markings change quickly, e.g. lanes branch off, cross one another or merge
- the road is narrow and winding
- there are highly variable shade conditions on the roadway

Switching on Lane Keeping Assist

- ▶ Switch on Active Lane Keeping Assist using the on-board computer; to do so, select **Standard** or **Adaptive** (▷ page 183). If you drive at speeds above 40 mph (60 km/h) and lane markings are detected, the lines in the assistance graphics display (▷ page 182) are shown in green. Lane Keeping Assist is ready for use.

If **Standard** is selected, no warning vibration occurs if:

- you have switched on the turn signal. In this event, the warnings are suppressed for a certain period of time.
- a driving safety system intervenes, e.g. ABS, BAS or ESP®.

When **Adaptive** is selected, no warning vibration occurs if:

- you have switched on the turn signal. In this event, the warnings are suppressed for a certain period of time.
- a driving safety system intervenes, e.g. ABS, BAS or ESP®.
- you accelerate hard, e.g. kickdown.
- you brake hard.
- you steer actively, e.g. swerve to avoid an obstacle or change lanes quickly.
- you cut the corner on a sharp bend.

In order that you are warned only when necessary and in good time if you cross the lane marking, the system recognizes certain conditions and warns you accordingly.

The warning vibration occurs earlier if:

- you approach the outer lane marking on a bend.
- the road has very wide lanes, e.g. a highway.
- the system detects solid lane markings.

The warning vibration occurs later if:

- the road has narrow lanes.
- you cut the corner on a bend.

Important safety notes

WARNING

If you operate information systems and communication equipment integrated in the vehicle while driving, you will be distracted from traffic conditions. You could also lose control of the vehicle. There is a risk of an accident.

Only operate the equipment when the traffic situation permits. If you are not sure that this is possible, park the vehicle paying attention to traffic conditions and operate the equipment when the vehicle is stationary.

You must observe the legal requirements for the country in which you are currently driving when operating the on-board computer.

WARNING

If the instrument cluster has failed or malfunctioned, you may not recognize function restrictions in systems relevant to safety. The operating safety of your vehicle may be impaired. There is a risk of an accident.

Drive on carefully. Have the vehicle checked at a qualified specialist workshop immediately.

The on-board computer only shows messages or warnings from certain systems in the multifunction display. You should therefore make sure your vehicle is operating safely at all times.

If the operating safety of your vehicle is impaired, pull over as soon as it is safe to do so. Contact a qualified specialist workshop.

For an overview, see the instrument panel illustration (▷ page 32).



Displays and operation

Instrument cluster lighting

The light sensor in the instrument cluster automatically controls the brightness of the multifunction display. In daylight, the displays in the instrument cluster are not illuminated.

The lighting in the instrument cluster, in the displays and the controls in the vehicle interior can be adjusted using the brightness control knob.

The brightness control knob is located on the bottom left of the instrument cluster (▷ page 32).

- ▶ Turn the brightness control knob clockwise or counter-clockwise.
If the light switch is set to the **AUTO**,  or  position, the brightness is dependent upon the brightness of the ambient light.

Speedometer with segments

The speedometer is divided into segments on vehicles with Distance Pilot DISTRONIC.

The segments in the speedometer indicate which speed range is available.

- Distance Pilot DISTRONIC is activated (▷ page 150):
One or two segments in the set speed range light up.
- Distance Pilot DISTRONIC detects a vehicle in front moving more slowly than the stored speed:
The segments between the speed of the vehicle in front and the stored speed light up.

Tachometer

-  Do not drive in the overrevving range, as this could damage the engine.

The red band in the tachometer indicates the engine's overrevving range.

The engine is limited within a range to protect the engine when the red band is reached.

Outside temperature display

You should pay special attention to road conditions when temperatures are around freezing point.

Bear in mind that the outside temperature display indicates the temperature measured and does not record the road temperature.

The outside temperature display is in the multifunction display (▷ page 176).

There is a short delay before a change in outside temperature appears in the multifunction display.

Coolant temperature gauge

WARNING

Opening the hood when the engine is overheated or when there is a fire in the engine compartment could expose you to hot gases or other service products. There is a risk of injury.

Let an overheated engine cool down before opening the hood. If there is a fire in the engine compartment, keep the hood closed and contact the fire department.

! A display message is shown if the coolant temperature is too high.

If the coolant temperature is over 248 °F (120 °C), do not continue driving. The engine will otherwise be damaged.

The coolant temperature gage is in the instrument cluster on the right-hand side (▷ page 32).

The **H** marking in the coolant temperature gauge corresponds to a coolant temperature of approximately 248 °F (120 °C).

Under normal operating conditions and at the correct coolant level, the coolant temperature gauge may rise to the **H** marking.

Operating the on-board computer

Overview

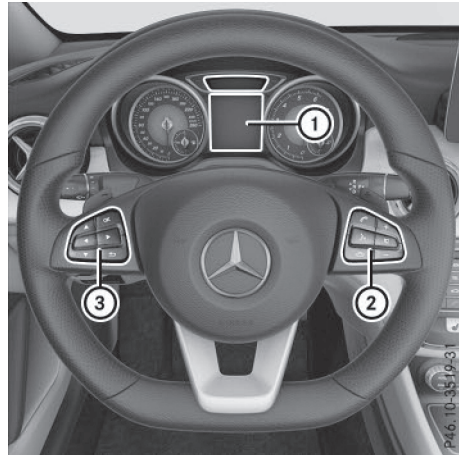



- ① Multifunction display
- ② Right control panel
- ③ Left control panel

► **To activate the on-board computer:** turn the SmartKey to position **1** in the ignition lock.

You can control the multifunction display and the settings in the on-board computer using the buttons on the multifunction steering wheel.

Left control panel

-  • Calls up the menu and menu bar
- 



Press briefly:

- Scrolls in lists
- Selects a submenu or function
- In the **Audio** menu: selects the previous or next station, when the preset list or station list is active, or an audio track or video scene
- In the **Te1** (telephone) menu: switches to the phone book and selects a name or telephone number

▲	Press and hold:
▼	
	<ul style="list-style-type: none"> In the Audio menu: selects a pre-set list or a station list in the desired frequency range, or an audio track or video scene using rapid scrolling In the Te1 (Telephone) menu: starts rapid scrolling if the phone book is open
OK	<ul style="list-style-type: none"> Confirms the selection or display message In the Te1 (Telephone) menu: switches to the phone book and starts dialing the selected number
←	Press briefly:
	<ul style="list-style-type: none"> Back Vehicles with Audio 20: switches off voice-operated control of the navigation (see manufacturer's operating instructions) Vehicles with COMAND: switches off the Voice Control System (see the separate operating instructions) Hides display messages or calls up the last Trip menu function used Exits the telephone book/redial memory
←	Press and hold:
	<ul style="list-style-type: none"> Calls up the standard display in the Trip menu

Right control panel

🔊	<ul style="list-style-type: none"> Vehicles with Audio 20: Switches on voice-operated control for navigation (see manufacturer's operating instructions) Vehicles with COMAND: Switches off the Voice Control System (see the separate operating instructions)
🔇	<ul style="list-style-type: none"> Mute
+	<ul style="list-style-type: none"> Adjusts the volume
-	

📞	<ul style="list-style-type: none"> Rejects or ends a call Exits the telephone book/redial memory
📞	<ul style="list-style-type: none"> Makes or accepts a call Switches to the redial memory

Multifunction display

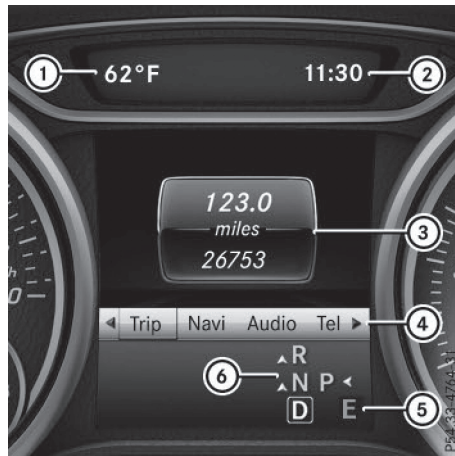

- Permanent display: outside temperature or speed (▷ page 184)
- Time
- Text field
- Menu bar
- Drive program (▷ page 129)
- Transmission position (▷ page 131)

In Mercedes-AMG vehicles, the indicators in the lower and upper part of the multifunction display differ from the displays shown here.

► **To display menu bar** ④: press the ◀ or ▶ button on the steering wheel.



If you do not press the buttons any longer, menu bar ④ is faded out after a few seconds.

Text field ③ shows the selected menu or sub-menu as well as display messages.

i Set the time using the multimedia system; see the separate operating instructions.



The following messages may appear in the multifunction display:

- ↑ Gearshift recommendation, when shifting manually (▷ page 135)
- P** Parking Pilot (▷ page 162)

- **CRUISE** Cruise control (▷ page 148)
-  Adaptive Highbeam Assist (▷ page 101)
-  ECO start/stop function (▷ page 125)
-  HOLD function (▷ page 156)

Menus and submenus

Menu overview

Using the  or  button on the steering wheel, open the menu bar. Operating the on-board computer (▷ page 175). Depending on the equipment installed in the vehicle, you can call up the following menus:

- **Trip** menu (▷ page 177)
- **Navi** menu (navigation instructions) (▷ page 178)
- **Audio** menu (▷ page 180)
- **Tel** menu (telephone) (▷ page 180)
- **DriveAssist** menu (assistance) (▷ page 182)
- **Serv.** menu (▷ page 183)
- **Sett.** menu (settings) (▷ page 183)
- **AMG** menu (Mercedes-AMG vehicles) (▷ page 185)

The displays for the **Audio**, **Navi** and **Tel** menus may differ slightly to those in your vehicle.

The examples given in this Operator's Manual apply to vehicles equipped with COMAND.

Trip menu

Standard display





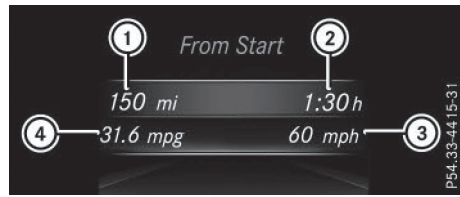

- ▶ Press and hold the  button on the steering wheel until the **Trip** menu with trip odometer ① and odometer ② appears.

Trip computer "From Start" or "From Reset"



- ① Distance
- ② Driving time
- ③ Average speed
- ④ Average fuel consumption

- ▶ Press the  or  button on the steering wheel to select the **Trip** menu.
- ▶ Press the  or  button to select **From Start** or **From Reset**.

The values in the **From Start** submenu are calculated from the start of a journey whilst the values in the **From Reset** submenu are calculated from the last time the submenu was reset (▷ page 178).





In the following cases, the trip computer is automatically reset **From Start**:

- the ignition has been switched off for more than four hours.
- 999 hours have been exceeded.
- 9,999 miles have been exceeded.

When 9,999 hours or 99,999 miles have been exceeded, the trip computer is automatically reset **From Reset**.

ECO display

The ECO display is not available in Mercedes-AMG vehicles.

- ▶ Press the  or  button on the steering wheel to select the **Trip** menu.
- ▶ Press the  or  button to select **ECO DISPLAY**.

If the ignition remains switched off for longer than four hours, the ECO display will be automatically reset.

For more information on the ECO display, see (▷ page 144).

Displaying the range and current fuel consumption

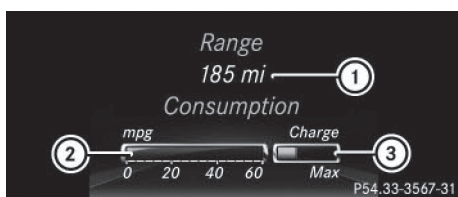

Mercedes-AMG vehicles: the menu only shows range ①.

- ▶ Press the ◀ or ▶ button on the steering wheel to select the **Trip** menu.
- ▶ Press ▲ or ▼ to select the display with approximate range ① and current fuel consumption ②.

Approximate range ① that can be covered is calculated according to your current driving style and the amount of fuel in the tank. If there is only a small amount of fuel left in the fuel tank, a vehicle being refueled  appears instead of approximate range ①.

Recuperation display ③ shows you if energy has been recuperated from the kinetic energy in overrun mode and saved in the battery. Recuperation display ③ depends on the engine installed and is therefore not available in all vehicles.

Digital speedometer

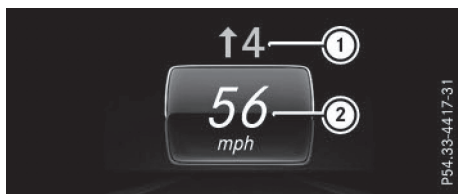

- ▶ Press the ◀ or ▶ button on the steering wheel to select the **Trip** menu.
- ▶ Press the ▲ or ▼ button to select the digital speedometer ②.
A gear shift recommendation ① ↑ can also follow.

Observe the information on gearshift recommendation ① when shifting manually (> page 135).

Mercedes-AMG vehicles: a gearshift recommendation is shown in the status bar of the

multifunction display and not in the digital speedometer display.

Resetting values

- ▶ Press the ◀ or ▶ button on the steering wheel to select the **Trip** menu.
- ▶ Press the ▲ or ▼ button to select the function that you wish to reset.
- ▶ Press **OK** to confirm.
- ▶ Press ▼ to select **Yes** and press **OK** to confirm.

You can reset the values of the following functions:

- Trip odometer
- "From Start" trip computer
- "From Reset" trip computer
- ECO display

If you reset the values in the ECO display, the values in the "From Start" trip computer are also reset. If you reset the values in the "From Start" trip computer, the values in the ECO display are also reset.

Navigation system menu

Displaying navigation instructions

In the **Navi** menu, the multifunction display shows navigation instructions.

You can find further information on navigation in the separate multimedia system operating instructions.

- ▶ Switch on the multimedia system (see separate operating instructions).
- ▶ Press the ◀ or ▶ button on the steering wheel to select the **Navi** menu.

Route guidance not active

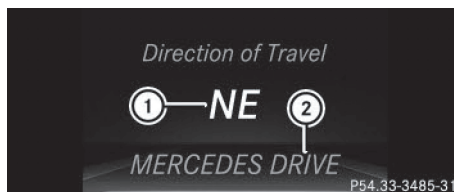

- ① Direction of travel
- ② Current road

Route guidance active

No change of direction announced

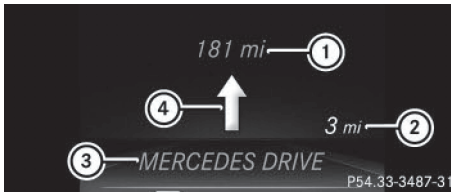

- ① Distance to destination
- ② Distance to the next change of direction
- ③ Current road
- ④ "Follow the road's course" symbol

Change of direction without lane recommendation

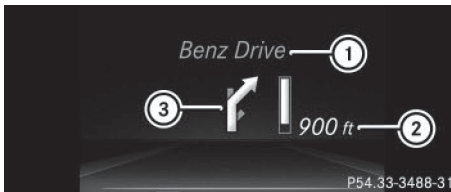

- ① Road into which the change of direction leads
- ② Distance to change of direction and visual distance display
- ③ Change-of-direction symbol

When a change of direction is to be made, you will see symbol ③ for the change of direction and distance graphic ②. The distance indicator shortens towards the top of the display as you approach the point of the announced change of direction. The change of direction starts once the distance display reaches zero.

Change of direction announced with a lane recommendation



- ① Road into which the change of direction leads
- ② Distance to change of direction and visual distance display

- ③ Lanes not recommended
- ④ Recommended lane and new lane during a change of direction
- ⑤ Change-of-direction symbol

On multilane roads, new lane recommendations can be displayed for the next change of direction if the digital map supports this data. During the change of direction, new lanes may be added.

Lane not recommended ③: you will not be able to complete the next change of direction if you stay in this lane.

Recommended lane and new lane during a change of direction ④: in this lane you will be able to complete the next two changes of direction without changing lane.

Other status indicators of the navigation system



The navigation system displays additional information and the vehicle status.

Possible displays:

- **New Route... or Calculating Route**
A new route is calculated.
- **Road Not Mapped**
The vehicle position is inside the area of the digital map but the road is not recognized, e.g. newly built streets, car parks or private land.
- **No Route**
No route could be calculated to the selected destination.
- 
You have reached the destination or an intermediate destination.

Audio menu

Selecting a radio station



- ① Active station list
- ② Station frequency with memory position

The multifunction display shows station ② with station frequency or station name. The preset position is only displayed along with station ② if this has been stored.

- ▶ Switch on the multimedia system and select Radio (see the separate operating instructions).
- ▶ Press the ◀ or ▶ button on the steering wheel to select the **Audio** menu.
- ▶ **To select a preset list or station list:** press and briefly hold the ▲ or ▼ button until the preset list or station list in the desired frequency range is shown.
- ▶ **To select a station:** briefly press ▲ or ▼.

i SIRIUS XM satellite radio functions like a normal radio.

You can find further information on operation in the "Satellite radio" section of the separate multimedia system operating instructions.

Operating an audio player or audio media



- ① Current title

Audio data from various audio devices or media can be played, depending on the equipment installed in the vehicle.

- ▶ Switch on the multimedia system and then audio CD or MP3 mode (see the separate operating instructions).
- ▶ Press the ◀ or ▶ button on the steering wheel to select the **Audio** menu.
- ▶ **To select the next/previous track:** briefly press the ▲ or ▼ button.
- ▶ **To select a track from the track list (rapid scrolling):** press and hold the ▲ or ▼ button until desired track appears.

If you press and hold ▲ or ▼, the rapid scrolling speed is increased. Not all audio drives or data carriers support this function.

If track information is stored on the audio device or medium, the multifunction display will show the number and title of the track.

Video DVD operation

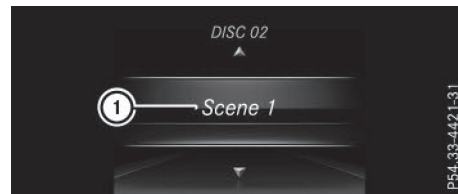

You can only operate DVD videos in the **Audio** menu in vehicles with COMAND.

- ▶ Switch on COMAND and select video DVD (see the separate operating instructions).
- ▶ Press the ◀ or ▶ button on the steering wheel to select the **Audio** menu.
- ▶ **To select the next or previous scene:** briefly press the ▲ or ▼ button.
- ▶ **To select a scene from the scene list (rapid scrolling):** press and hold the ▲ or ▼ button until desired scene ① appears.

Telephone menu

Introduction



⚠ WARNING

If you operate information systems and communication equipment integrated in the vehi-

cle while driving, you will be distracted from traffic conditions. You could also lose control of the vehicle. There is a risk of an accident.

Only operate the equipment when the traffic situation permits. If you are not sure that this is possible, park the vehicle paying attention to traffic conditions and operate the equipment when the vehicle is stationary.

When telephoning, you must observe the legal requirements for the country in which you are currently driving.

- ▶ Switch on the mobile phone (see the manufacturer's operating instructions).
- ▶ Switch on the multimedia system (see separate operating instructions).
- ▶ Establish a Bluetooth® connection to the multimedia system; see the separate operating instructions.
- ▶ Press the  or  button on the steering wheel to select the **Te1** menu.

You will see one of the following display messages in the multifunction display:

- **Telephone READY** or the name of the network provider: the mobile phone has found a network and is ready to receive.
- **Telephone No service**: there is no network available or the mobile phone is searching for a network.

Accepting a call

If someone calls you when you are in the **Te1** menu, a display message appears in the multifunction display.

You can accept a call at any time, even if you are not in the **Te1** menu.







- ▶ Press the  button on the steering wheel to accept an incoming call.

Rejecting or ending a call



You can end or reject a call anytime, even if you are not in the **Te1** menu.

- ▶ Press the  button on the steering wheel to reject or end a call.

Selecting an entry in the phone book



- ▶ Press the  or  button on the steering wheel to select the **Te1** menu.
- ▶ Press the ,  or  button to switch to the phone book.
- ▶ Authorize access to the phone book on the phone.
- ▶ Press the  or  button to select the desired name.





or

- ▶ **To begin rapid scrolling:** press and hold the  or  button for longer than one second. Rapid scrolling stops when you release the button or reach the end of the list.



- ▶ **If only one telephone number is stored for a name:** press the  or  button to start dialing.

or

- ▶ **If there is more than one number for a particular name:** press the  or  button to display the numbers.



- ▶ Press the  or  button to select the number you want to dial.
- ▶ Press the  or  button to start dialing.

or

- ▶ **If you do not want to make a call:** press the  or  button.

Redialing



The on-board computer saves the last names or numbers dialed in the redial memory.

- ▶ Press the  or  button on the steering wheel to select the **Te1** menu.
- ▶ Press the  button to switch to the redial memory.

- ▶ Press the  or  button to select the desired name or number.

- ▶ Press the  or  button to start dialing.

or

- ▶ **If you do not want to make the call:** press the  or  button.

Assistance menu

Introduction

Depending on the equipment installed in the vehicle, you have the following options in the **DriveAssist** menu:

- Displaying the assistance graphic (▷ page 182)
- Deactivating/activating ESP® (except Mercedes-AMG vehicles) (▷ page 182)
- Activating/deactivating Active Brake Assist (▷ page 182)
- Activating/deactivating ATTENTION ASSIST (▷ page 183)
- Activating/deactivating Blind Spot Assist (▷ page 183)
- Activating/deactivating Lane Keeping Assist (▷ page 183)

Displaying the assistance graphic

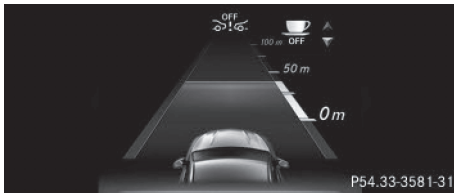

- ▶ Press the ◀ or ▶ button on the steering wheel to select the **DriveAssist** menu.
- ▶ Press ▲ or ▼ to select **Assistance Graphic**.
- ▶ Press **OK** to confirm.
The multifunction display shows the distance display of Distance Pilot DISTRONIC in the assistance graphic.
The assistance graphic displays the status of and information from the following driving systems or driving safety systems:
 - Distance Pilot DISTRONIC (▷ page 150)
 - Active Brake Assist (▷ page 61)
 - ATTENTION ASSIST (▷ page 169)
 - Lane Keeping Assist (▷ page 172)
- ▶ Press ▼ to display the ATTENTION ASSIST assessment.

Deactivating/activating ESP®

Observe the important safety notes on ESP® (▷ page 63).

⚠ WARNING

If you deactivate ESP®, ESP® no longer stabilizes the vehicle. There is an increased risk of skidding and an accident.

Only deactivate ESP® in the situations described in the following.



It may be best to deactivate ESP® in the following situations:

- when using snow chains
- in deep snow
- on sand or gravel

Deactivating/activating ESP® in Mercedes-AMG vehicles (▷ page 65).

For further information about ESP®, see (▷ page 63).

- ▶ Start the engine.
- ▶ Press the ◀ or ▶ button on the steering wheel to select the **DriveAssist** menu.
- ▶ Press ▲ or ▼ to select **ESP**.
- ▶ Press **OK** to confirm.
The current selection appears.
- ▶ **To activate/deactivate:** press the **OK** button again.
ESP® is deactivated if the  warning lamp in the instrument cluster lights up continuously when the engine is running.

If the  and  warning lamps light up continuously, ESP® is not available due to a malfunction.

Observe the information on warning lamps (▷ page 219).

Observe the information on display messages (▷ page 189).







Activating or deactivating Active Brake Assist

- ▶ Press the ◀ or ▶ button on the steering wheel to select the **DriveAssist** menu.
- ▶ Press the ▲ or ▼ button to select **Brake Assist**.

- ▶ Press **OK** to confirm.
The current selection appears.
- ▶ **To activate/deactivate:** press the **OK** button again.
When Active Brake Assist is deactivated, the  symbol appears in the multifunction display in the assistance graphic display.





Further information on Active Brake Assist (▷ page 61).

Activating/deactivating ATTENTION ASSIST

- ▶ Press the  or  button on the steering wheel to select the **DriveAssist** menu.
- ▶ Press the  or  button to select **Attention Assist**.
- ▶ Press **OK** to confirm.
The current selection appears.
- ▶ Press **OK** to confirm.
- ▶ Press the  or  button to set **Off**, **Standard** or **Sensitive**.
- ▶ Press the **OK** button to save the setting.
When ATTENTION ASSIST is deactivated, the  symbol appears in the assistance graphics display.



For further information about ATTENTION ASSIST, see (▷ page 169).



Activating/deactivating Blind Spot Assist

- ▶ Press the  or  button on the steering wheel to select the **DriveAssist** menu.
- ▶ Press the  or  button to select **Blind Spot Assist**.
- ▶ Press **OK** to confirm.
The current selection appears.
- ▶ **To activate/deactivate:** press the **OK** button again.

For further information about Blind Spot Assist, see (▷ page 171).

Activating/deactivating Lane Keeping Assist

- ▶ Press the  or  button on the steering wheel to select the **DriveAssist** menu.
- ▶ Press the  or  button to select **Lane Keeping Assist**.

- ▶ Press **OK** to confirm.
The current selection appears.
- ▶ Press **OK** again to confirm.
- ▶ Press the  or  button to set **Off**, **Standard** or **Adaptive**.
- ▶ Press the **OK** button to save the setting.
When Lane Keeping Assist is activated, the multifunction display shows the lane markings as bright lines in the assistance graphic.

For further information about Lane Keeping Assist, see (▷ page 172).

Service menu

Depending on the equipment installed in the vehicle, you have the following options in the **Serv.** menu:

- Calling up display messages in message memory (▷ page 188)
- Restarting the tire pressure loss warning system (Canada only) (▷ page 289)
- Checking the tire pressure electronically (USA only) (▷ page 289)
- Calling up the service due date (▷ page 258)

Settings menu

Introduction

Depending on the equipment installed in the vehicle, you have the following options in the **Sett.** menu:

- Changing the instrument cluster settings
- Changing the light settings
- Changing the vehicle settings
- Changing the convenience settings
- Restoring the factory settings

Instrument cluster

Selecting the distance unit

The **Display Unit Speed-/Odometer:** function allows you to choose whether certain displays appear in kilometers or miles in the multifunction display.

- ▶ Press the or button on the steering wheel to select the **Sett.** menu.
- ▶ Press the or button to select the **Instrument Cluster** submenu.
- ▶ Press to confirm.
- ▶ Press the or button to select the **Display Unit Speed-/Odometer** function. You will see the selected setting: **km** or **miles**.
- ▶ Press the button to save the setting.

The selected unit of measurement for distance applies to:

- Digital speedometer in the **Trip** menu
- Odometer and the trip odometer
- Trip computer
- Current fuel consumption and approximate range
- Navigation instructions in the **Navi** menu
- Cruise control
- Distance Pilot DISTRONIC
- ASSYST PLUS service interval display

Switching the additional speedometer on/off

If the additional speedometer is switched on, the speed is shown in the status area of the multifunction display instead of the outside temperature.

The speed display is inverse to the speedometer.

- ▶ Press the or button on the steering wheel to select the **Sett.** menu.
- ▶ Press the or button to select the **Instrument Cluster** submenu.
- ▶ Press to confirm.
- ▶ Press the or button to select the **Speedometer [km/h]** or **Speedometer [mph]** function. You will see the selected setting: **On** or **Off**.
- ▶ Press the button to save the setting.

Selecting permanent display

The **Permanent Display:** function allows you to choose whether the multifunction display always shows the outside temperature or the speed.

The speed display is inverse to the speedometer.

- ▶ Press the or button on the steering wheel to select the **Sett.** menu.
- ▶ Press the or button to select the **Instrument Cluster** submenu.
- ▶ Press to confirm.
- ▶ Press the or button to select the **Permanent Display:** function. The current setting **Outside Temperature** or **Speedometer [km/h]/Speedometer [mph]** appears.
- ▶ Press the button to save the setting.

Lights

Switching the daytime running lamps on/off

This function is not available in Canada.

- ▶ Press the or button on the steering wheel to select the **Sett.** menu.
- ▶ Press the or button to select the **Light** submenu.
- ▶ Press to confirm.
- ▶ Press the or button to select the **Daytime Running Lights** function. If the **Daytime Running Lights** function has been switched on, the multifunction display shows the cone of light and the symbol in orange.
- ▶ Press the button to save the setting.

Further information on daytime running lamps (> page 99).

Vehicle

Activating/deactivating the automatic door locking mechanism

- ▶ Press the or button on the steering wheel to select the **Sett.** menu.
- ▶ Press the or button to select the **Vehicle** submenu.
- ▶ Press to confirm.
- ▶ Press the or button to select the **Automatic Door Lock** function. If the **Automatic Door Lock** function is switched on, the multifunction display shows the doors in orange.
- ▶ Press the button to save the setting.

If you activate the **Automatic door locks** function, the vehicle is centrally locked above a speed of around 9 mph (15 km/h).

For further information on the automatic locking feature, see (> page 76).

Activating/deactivating the acoustic locking verification signal

If you switch on the **Acoustic Lock** function, an acoustic signal sounds when you lock the vehicle.

- ▶ Press the ◀ or ▶ button on the steering wheel to select the **Sett.** menu.
- ▶ Press the ▼ or ▲ button to select the **Vehicle** submenu.
- ▶ Press **OK** to confirm.
- ▶ Press the ▼ or ▲ button to select the **Acoustic Lock** function.
If the **Acoustic Lock** function is activated, the multifunction display shows the  symbol in orange.
- ▶ Press the **OK** button to save the setting.

Convenience

Switching the fold-in mirrors when lock-in feature on/off

This function is only available in Canada.

This function is only available when the vehicle is equipped with the electrical fold-in function.

When you activate the **Auto. Mirror Folding** function, the exterior mirrors are folded in when the vehicle is locked. If you unlock the vehicle and then open the driver's or front-passenger door, the exterior mirrors fold out again.

If you have switched on the **Auto. Mirror Folding** function and you fold in the exterior mirrors using the button on the door (> page 96), they will not fold out automatically. The exterior mirrors can then only be folded out using the button on the door.

- ▶ Press the ◀ or ▶ button on the steering wheel to select the **Sett.** menu.
- ▶ Press the ▼ or ▲ button to select the **Convenience** submenu.
- ▶ Press **OK** to confirm.
- ▶ Press the ▼ or ▲ button to select the **Auto. Mirror Folding** function.
If the **Auto. Mirror Folding** function is switched on, the multifunction display shows the exterior mirror in orange.
- ▶ Press the **OK** button to save the setting.

Restoring the factory settings

- ▶ Press the ◀ or ▶ button on the steering wheel to select the **Sett.** menu.
- ▶ Press the ▼ or ▲ button to select the **Factory Setting** submenu.
- ▶ Press **OK** to confirm.
The **Reset All Settings?** function appears.
- ▶ Press the ▼ or ▲ button to select **No** or **Yes**.
- ▶ Press the **OK** button to confirm the selection.
If you have selected **Yes**, the multifunction display shows a confirmation message.

For safety reasons, the **Daytime Running Lights** function in the **Light** submenu is only reset if the vehicle is stationary.

AMG menu (Mercedes-AMG vehicles)

Warm-up



- ① Digital speedometer
 - ② Gear indicator
 - ③ Upshift indicator
 - ④ Engine oil temperature
 - ⑤ Coolant temperature
 - ⑥ Transmission fluid temperature
- ▶ Press the ◀ or ▶ button on the steering wheel to select the **AMG** menu.
Upshift indicator: upshift indicator **UP** ③ indicates that the engine has reached the overrevving range when in the manual drive program.
- Engine and transmission oil temperature:** when the engine and transmission are at normal operating temperature, oil temperature ④ and ⑥ are displayed in white in the multifunction display.
If the multifunction display shows oil temperature ④ or ⑥ in blue, the engine or the transmission are not yet at normal operating

temperature. Avoid driving at full engine output during this time.

SETUP

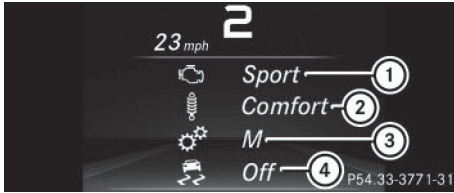

- ① Drive **Comfort/Sport/Sport +**
- ② Chassis **Comfort/Sport/Sport +**
- ③ Transmission **D/M**
- ④ ESP® **On/Off** or SPORT handling mode **Sport**

SETUP displays the following information and functions:

- the digital speedometer
 - the gear indicator
 - the drive system setting
 - the suspension mode
 - the transmission position
 - the ESP® (Electronic Stability Program) status
- ▶ Press or on the steering wheel to select the **AMG** menu.
- ▶ Press repeatedly until **SETUP** appears.

RACETIMER

Displaying and starting RACETIMER



- ① Lap
- ② RACETIMER

The RACETIMER is only intended for use on a closed race circuit. Do not use the function on public roads.

You can start the RACETIMER when the engine is running or if the SmartKey is in position **2** in the ignition lock.

- ▶ Press or on the steering wheel to select the **AMG** menu.
- ▶ Press the button repeatedly until the RACETIMER appears.
- ▶ **To start:** press the button to start the RACETIMER.

Displaying the intermediate time



- ▶ Press the or button to select **Interm. Time**.
- ▶ Press to confirm. The intermediate time appears for five seconds.

Starting a new lap



- ① RACETIMER
 - ② Fastest lap time (best lap)
 - ③ Lap
- ▶ Press to confirm **New Lap**.

i It is possible to store a maximum of sixteen laps. The 16th lap can only be completed with **Finish Lap**.

Stopping the RACETIMER



- ▶ Press the button on the steering wheel.
- ▶ Confirm **Yes** with .

The RACETIMER interrupts timing if you stop the vehicle and turn the SmartKey to position **1** in the ignition lock. If you turn the key to position **3** and then press to confirm **Start**, timing is continued.

Resetting the current lap

- ▶ Stop the RACETIMER.
- ▶ Press the or button to select **Reset Lap**.
- ▶ Press to reset the lap time to "0".

Deleting all laps



If you switch off the engine, the RACETIMER is reset to "0" after 30 seconds. All laps are deleted.

You cannot delete individual stored laps. If you have stopped 16 laps, the current lap does not have to be reset.

- ▶ Reset the current lap.
- ▶ Press to confirm **Reset**. **Reset Race-Timer?** appears in the multi-function display.
- ▶ Press the button to select **Yes** and press the button to confirm. All laps are deleted.

Overall statistics

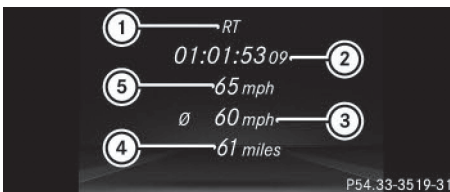

- ① RACETIMER overall evaluation
- ② Total time driven

- ③ Average speed
- ④ Distance covered
- ⑤ Maximum speed

This function is shown if you have stored at least one lap and stopped the RACETIMER.

- ▶ Press the or button on the steering wheel to select the **AMG** menu.
- ▶ Press the button repeatedly until the overall evaluation appears.

Lap statistics

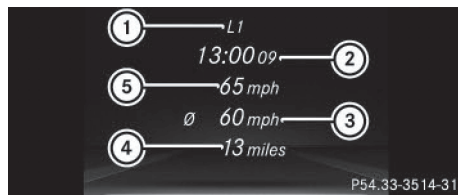

- ① Lap
- ② Lap time
- ③ Average lap speed
- ④ Lap length
- ⑤ Top speed during lap

This function is only available if you have stored at least two laps and have stopped the RACETIMER.

- ▶ Press the or button on the steering wheel to select the **AMG** menu.
- ▶ Press repeatedly until a lap evaluation appears. Each lap appears in a separate submenu. The fastest lap is indicated by flashing symbol ①.
- ▶ Press the or button to select a different lap evaluation.

Display messages

Introduction

General notes

Display messages appear in the multifunction display.

Display messages with graphic displays may be shown in simplified form in the Operator's Manual and may therefore differ from the multifunction display.

Please respond in accordance with the display messages and follow the additional notes in this Operator's Manual.

Certain display messages are accompanied by an audible warning tone or a continuous tone.

When the ignition is switched off, all display messages are deleted, apart from some high-priority display messages. Once the causes of the high-priority display messages have been rectified, the corresponding display messages are also deleted.

When you stop and park the vehicle, please observe the notes on:

- HOLD function (▷ page 156)
- Parking (▷ page 140)

Hiding display messages

- ▶ Press the or button on the steering wheel.
The multifunction display hides the display message.









The multifunction display shows high-priority display messages in red. Some high-priority display messages cannot be hidden.

The multifunction display shows these messages continuously until the causes for the messages have been remedied.

Message memory

The on-board computer saves certain display messages in the **message memory**. You can call up the display messages:

- ▶ Press the or button on the steering wheel to select the **Serv.** menu.
If there are display messages, the multifunction display shows **2 Messages**, for example.
- ▶ Press the or button to select the entry, e.g. **2 Messages**.
- ▶ Press to confirm.
- ▶ Press the or button to scroll through the display messages.

Safety systems	
Display messages	Possible causes/consequences and ► Solutions
 <p>Currently Unavailable See Operator's Manual</p>	<p>ABS (Anti-lock Braking System), BAS (Brake Assist), ESP® (Electronic Stability Program), the HOLD function and hill start assist are temporarily unavailable.</p> <p>Active Brake Assist may have also failed.</p> <p>In addition, the ,  and  warning lamps may light up in the instrument cluster.</p> <p>ATTENTION ASSIST is deactivated.</p> <p>Possible causes are:</p> <ul style="list-style-type: none"> • Self-diagnosis is not yet complete. • The on-board voltage may be insufficient. <p>⚠ WARNING</p> <p>The brake system continues to function normally, but without the functions listed above. The wheels could therefore lock if you brake hard, for example.</p> <p>The steerability and braking characteristics may be severely affected. The braking distance in an emergency braking situation can increase. If ESP® is not operational, ESP® is unable to stabilize the vehicle. There is an increased risk of skidding and an accident.</p> <p>► Carefully drive a short distance on a suitable stretch of road, making slight steering movements at a speed above 12 mph (20 km/h). If the display message disappears, the functions mentioned above are available again.</p> <p>If the multifunction display still shows the display message:</p> <ul style="list-style-type: none"> ► Drive on carefully. ► Visit a qualified specialist workshop immediately.
 <p>Inoperative See Operator's Manual</p>	<p>ABS, BAS, ESP®, the HOLD function and hill start assist are not available due to a malfunction.</p> <p>Active Brake Assist may have also failed.</p> <p>The , ,  and BRAKE (USA only) or  (Canada only) warning lamps in the instrument cluster may also light up.</p> <p>ATTENTION ASSIST is deactivated.</p> <p>⚠ WARNING</p> <p>The brake system continues to function normally, but without the functions listed above. The wheels could therefore lock if you brake hard, for example.</p> <p>The steerability and braking characteristics may be severely affected. The braking distance in an emergency braking situation can increase. If ESP® is not operational, ESP® is unable to stabilize the vehicle. There is an increased risk of skidding and an accident.</p> <ul style="list-style-type: none"> ► Drive on carefully. ► Visit a qualified specialist workshop immediately.

Display messages



Possible causes/consequences and ► Solutions



Currently Unavailable See Operator's Manual

ESP®, BAS, the HOLD function and hill start assist are temporarily unavailable.

Active Brake Assist may have also failed.

In addition, the  and  warning lamps may light up in the instrument cluster.

ATTENTION ASSIST is deactivated.

The self-diagnosis function might not be complete, for example.

 **WARNING**

The brake system continues to function normally, but without the functions listed above.

The braking distance in an emergency braking situation can thus increase.

If ESP® is not operational, ESP® is unable to stabilize the vehicle.

There is an increased risk of skidding and an accident.

► Carefully drive a suitable distance, making slight steering movements at a speed above 12 mph (20 km/h).

If the display message disappears, the functions mentioned above are available again.

If the multifunction display still shows the display message:

► Drive on carefully.



► Visit a qualified specialist workshop immediately.



Currently Unavailable See Operator's Manual

ESP®, BAS, the HOLD function and hill start assist are unavailable due to a malfunction.

Active Brake Assist may have also failed.

In addition, the  and  warning lamps may light up in the instrument cluster.

ATTENTION ASSIST is deactivated.

 **WARNING**

The brake system continues to function normally, but without the functions listed above.















The braking distance in an emergency braking situation can thus increase.









If ESP® is not operational, ESP® is unable to stabilize the vehicle.











There is an increased risk of skidding and an accident.











► Drive on carefully.







► Visit a qualified specialist workshop immediately.







Display messages	Possible causes/consequences and ► Solutions
  Inoperative See Operator's Manual	<p>EBD (electronic brake force distribution), ABS, BAS, ESP[®], the HOLD function and hill start assist are not available due to a malfunction. Active Brake Assist may have also failed. A warning tone sounds.</p> <p>In addition, the ,  and  warning lamps may light up in the instrument cluster.</p> <p>▲ WARNING</p> <p>The brake system continues to function normally, but without the functions listed above. The front and rear wheels could therefore lock if you brake hard, for example.</p> <p>The steerability and braking characteristics may be severely affected. The braking distance in an emergency braking situation can increase. If ESP[®] is not operational, ESP[®] is unable to stabilize the vehicle. There is an increased risk of skidding and an accident.</p> <ul style="list-style-type: none"> ► Drive on carefully. ► Visit a qualified specialist workshop immediately.
 Turn On the Ignition to Release the Parking Brake	<p>The red  (USA only) or  (Canada only) indicator lamp lights up.</p> <p>You attempted to release the electric parking brake while the ignition was switched off.</p> <ul style="list-style-type: none"> ► SmartKey: turn the SmartKey to position 1 in the ignition lock. ► KEYLESS-GO: switch on the ignition.
 Please Release Parking Brake	<p>The red  (USA only) or  (Canada only) indicator lamp flashes and a warning tone sounds. A condition for automatic release of the electric parking brake is not fulfilled (► page 141).</p> <p>You are driving with the electric parking brake applied.</p> <ul style="list-style-type: none"> ► Release the electric parking brake manually. <p>The red  (USA only) or  (Canada only) indicator lamp flashes and a warning tone sounds.</p> <p>You are using the electric parking brake for emergency braking (► page 141).</p>
 Parking Brake See Operator's Manual	<p>The yellow  warning lamp lights up. The electric parking brake is malfunctioning.</p> <p>To apply:</p> <ul style="list-style-type: none"> ► Switch the ignition off. ► Press the electric parking brake handle for at least ten seconds. ► Shift the transmission to position P. ► Consult a qualified specialist workshop.

Display messages	Possible causes/consequences and ► Solutions
	<p>The yellow  warning lamp and the red  (USA only) or  (Canada only) indicator lamp light up. The electric parking brake is malfunctioning.</p> <p>To release:</p> <ul style="list-style-type: none"> ► Switch off the ignition and turn it back on. ► Release the electric parking brake manually. <p>or</p> <ul style="list-style-type: none"> ► Release the electric parking brake automatically (▷ page 141). <p>If the electric parking brake still cannot be released:</p> <ul style="list-style-type: none"> ► Do not drive on. ► Consult a qualified specialist workshop. <hr/> <p>The red  (USA only) or  (Canada only) indicator lamp flashes and the yellow  warning lamp lights up. The electric parking brake is malfunctioning.</p> <p>To release:</p> <ul style="list-style-type: none"> ► Switch off the ignition and turn it back on. ► Release the electric parking brake manually. <p>To apply:</p> <ul style="list-style-type: none"> ► Switch off the ignition and turn it back on. ► Apply the electric parking brake manually. <p>If the red  (USA only) or  (Canada only) indicator lamp continues to flash:</p> <ul style="list-style-type: none"> ► Do not drive on. ► Secure the vehicle against rolling away (▷ page 302). ► Shift the transmission to position P. ► Turn the front wheels towards the curb. ► Consult a qualified specialist workshop.

Display messages	Possible causes/consequences and ► Solutions
	<p>The yellow  warning lamp lights up. The red  (USA only) or  (Canada only) indicator lamp flashes for about ten seconds after the electric parking brake has been applied or released. It then goes out or remains lit.</p> <p>The electric parking brake is malfunctioning.</p> <ul style="list-style-type: none"> ► Switch off the ignition and turn it back on. ► Apply the electric parking brake. <p>If it is not possible to engage the electric parking brake:</p> <ul style="list-style-type: none"> ► Shift the transmission to position P. ► Visit a qualified specialist workshop. <p>If it is not possible to release the electric parking brake manually:</p> <ul style="list-style-type: none"> ► Release the electric parking brake automatically (> page 141). <p>If the electric parking brake still cannot be released:</p> <ul style="list-style-type: none"> ► Consult a qualified specialist workshop. <hr/> <p>The yellow  warning lamp lights up. If you manually apply or release the electric parking brake, the red  (USA only) or  (Canada only) indicator lamp flashes.</p> <p>The electric parking brake is malfunctioning. It is not possible to apply the electric parking brake manually.</p> <ul style="list-style-type: none"> ► Shift the selector lever to P, as the electric parking brake is not applied automatically. ► Visit a qualified specialist workshop.
<p> (USA only)  (Canada only)</p> <p>Parking Brake Inoperative</p>	<p>The yellow  warning lamp lights up. The red  (USA only) or  (Canada only) indicator lamp flashes for about ten seconds after the electric parking brake has been applied or released. It then goes out or remains lit.</p> <p>The electric parking brake is malfunctioning, e.g. because of overvoltage or undervoltage.</p> <ul style="list-style-type: none"> ► Remove the cause for the overvoltage or undervoltage, e.g. by charging the battery or restarting the engine. ► Engage or release the electric parking brake. <p>If it remains impossible to apply or release the electric parking brake:</p> <ul style="list-style-type: none"> ► Switch off the ignition and turn it back on. ► Engage or release the electric parking brake. <p>If the electric parking brake still cannot be released:</p> <ul style="list-style-type: none"> ► Consult a qualified specialist workshop. <p>If the electric parking brake still cannot be applied:</p> <ul style="list-style-type: none"> ► Visit a qualified specialist workshop.

Display messages	Possible causes/consequences and ► Solutions
	<p>The yellow  warning lamp lights up and the red  (USA only) or  (Canada only) indicator lamp flashes.</p> <p>It is not possible to apply the electric parking brake manually.</p> <ul style="list-style-type: none"> ► Shift the transmission to position P. ► Visit a qualified specialist workshop.
<p> (USA only)  (Canada only)</p> <p>Check Brake Fluid Level</p>	<p>There is not enough brake fluid in the brake fluid reservoir. A warning tone sounds. The  (USA only) or  (Canada only) warning lamps in the instrument cluster may also light up.</p> <p> WARNING</p> <p>The braking effect may be impaired. There is a risk of an accident.</p> <ul style="list-style-type: none"> ► Pull over and stop the vehicle safely as soon as possible, paying attention to road and traffic conditions. Do not continue driving under any circumstances. ► Secure the vehicle against rolling away (▷ page 140). ► Consult a qualified specialist workshop. ► Do not add brake fluid. This does not correct the malfunction.
<p></p> <p>Check Brake Pad Wear</p>	<p>The brake pads/linings have reached their wear limit.</p> <ul style="list-style-type: none"> ► Visit a qualified specialist workshop.
<p></p> <p>Inoperative</p>	<p>One or more main features of the mbrace system are malfunctioning.</p> <ul style="list-style-type: none"> ► Visit a qualified specialist workshop.
<p>Active Brake Assist Functions Currently Limited See Operator's Manual</p>	<p>Active Brake Assist is temporarily inoperative. Possible causes are:</p> <ul style="list-style-type: none"> • the radar sensor system is temporarily inoperative, e.g. due to electromagnetic radiation emitted by nearby TV or radio stations or other sources of electromagnetic radiation • the system is outside the operating temperature range • the on-board voltage is too low <p>When the causes stated above no longer apply, the display message disappears. Active Brake Assist is operational again.</p> <p>If the display message does not disappear:</p> <ul style="list-style-type: none"> ► Pull over and stop the vehicle safely as soon as possible, paying attention to road and traffic conditions. ► Secure the vehicle against rolling away (▷ page 140). ► Restart the engine.
<p>Active Brake Assist: System Inoperative</p>	<p>Active Brake Assist is unavailable due to a malfunction. Situation-dependent parking assistance may also have failed.</p> <ul style="list-style-type: none"> ► Visit a qualified specialist workshop immediately.

Display messages	Possible causes/consequences and ► Solutions
<p>Radar Sensors Dirty See Operator's Manual</p>	<p>The radar sensor system is malfunctioning. Possible causes are:</p> <ul style="list-style-type: none"> • Dirt on sensors • Heavy rain or snow • When driving on inter-urban roads without traffic or infrastructure, e.g. in desert-like areas <p>At least one driving system or driving safety system is malfunctioning or is temporarily unavailable:</p> <ul style="list-style-type: none"> • Active Brake Assist • Distance Pilot DISTRONIC <p>A warning tone also sounds.</p> <p>Once the cause of the problem is no longer present, the driving and drive safety systems will be available again. The display message disappears.</p> <p>If the display message does not disappear:</p> <ul style="list-style-type: none"> ► Pull over and stop the vehicle safely as soon as possible, paying attention to road and traffic conditions. ► Secure the vehicle against rolling away (▷ page 140). ► Switch off the engine. ► Clean all sensors (▷ page 262). ► Restart the engine. The display message disappears.
<p> SRS Malfunction Service Required</p>	<p>The restraint system is malfunctioning. The  warning lamp also lights up in the instrument cluster.</p> <p> WARNING</p> <p>The air bags or Emergency Tensioning Devices may either be triggered unintentionally or, in the event of an accident, may not be triggered. There is an increased risk of injury.</p> <ul style="list-style-type: none"> ► Visit a qualified specialist workshop immediately. <p>For further information about the restraint system, see (▷ page 39).</p>
<p> Front Left Malfunction Service Required or Front Right Malfunction Service Required</p>	<p>The restraint system is malfunctioning at the front on the left or right. The  warning lamp also lights up in the instrument cluster.</p> <p> WARNING</p> <p>The air bags or Emergency Tensioning Devices may either be triggered unintentionally or, in the event of an accident, may not be triggered. There is an increased risk of injury.</p> <ul style="list-style-type: none"> ► Visit a qualified specialist workshop immediately.

Display messages	Possible causes/consequences and ► Solutions
 <p>Rear Left Malfunction Service Required or Rear Right Malfunction Service Required</p>	<p>The rear left-hand or right-hand restraint system is malfunctioning. The  warning lamp also lights up in the instrument cluster.</p> <p> WARNING</p> <p>The air bags or Emergency Tensioning Devices may either be triggered unintentionally or, in the event of an accident, may not be triggered. There is an increased risk of injury.</p> <p>► Visit a qualified specialist workshop immediately.</p>
 <p>Left Side Curtain Airbag Malfunction Service Required or Right Side Curtain Airbag Malfunction Service Required</p>	<p>The left-hand or right-hand window curtain air bag is malfunctioning. The  warning lamp also lights up in the instrument cluster.</p> <p> WARNING</p> <p>The left or right window curtain air bag may either be triggered unintentionally or, in the event of an accident, may not be triggered. There is an increased risk of injury.</p> <p>► Visit a qualified specialist workshop immediately.</p>







Display messages	Possible causes/consequences and ► Solutions
<p>Front Passenger Air-bag Disabled See Operator's Manual</p>	<p>The front-passenger air bag and front-passenger knee bag are deactivated during the journey, although:</p> <ul style="list-style-type: none"> • an adult or • a person of the corresponding stature is on the front-passenger seat <p>If additional forces are applied to the seat, the system may interpret the occupant's weight as lower than it actually is.</p> <p>⚠ WARNING</p> <p>The front-passenger front air bag and front passenger knee bag may not be triggered in the event of an accident.</p> <p>There is an increased risk of injury.</p> <ul style="list-style-type: none"> ► Pull over and stop the vehicle safely as soon as possible, paying attention to road and traffic conditions. ► Secure the vehicle against rolling away (► page 140). ► Switch the ignition off. ► Have the occupant get out of the vehicle. ► Keep the seat unoccupied, close the front-passenger door and switch on the ignition. ► Observe the PASSENGER AIR BAG indicator lamps in the center console and the multifunction display and check the following: <ul style="list-style-type: none"> Seat unoccupied and ignition switched on: <ul style="list-style-type: none"> • a self-diagnosis is carried out. The PASSENGER AIR BAG OFF and PASSENGER AIR BAG ON indicator lamps must light up simultaneously for approximately six seconds • the PASSENGER AIR BAG OFF indicator lamp must then light up and remain lit after the self-diagnosis. If the indicator lamp is on, OCS (Occupant Classification System) has disabled the front-passenger front air bag and front-passenger knee bag (► page 47) • The Front Passenger Airbag Enabled See Operator's Manual or Front Passenger Airbag Disabled See Operator's Manual display messages must not be shown in the multifunction display ► Wait for a period of at least 60 seconds until the necessary system checks have been completed. ► Make sure that the display messages do not appear in the multifunction display. <p>If these conditions are fulfilled, the front-passenger seat can be occupied again. Whether the PASSENGER AIR BAG OFF or ON indicator lamp remains lit or goes out depends on how OCS classifies the occupant.</p> <p>If the conditions are not fulfilled, the system is not operating correctly.</p> <ul style="list-style-type: none"> ► Visit a qualified specialist workshop immediately. <p>For further information about the Occupant Classification System, see (► page 47).</p>









Display messages	Possible causes/consequences and ► Solutions
<p>Front Passenger Air-bag Enabled See Operator's Manual</p>	<p>The front-passenger air bag and front-passenger knee bag are enabled during the journey, even though:</p> <ul style="list-style-type: none"> • a child, a small adult or an object weighing less than the system's weight threshold is located on the front-passenger seat or • the front-passenger seat is unoccupied <p>The system may detect objects or forces applying additional weight on the seat.</p> <p> WARNING</p> <p>The front-passenger front air bag and front-passenger knee bag may be triggered unintentionally.</p> <p>There is an increased risk of injury.</p> <ul style="list-style-type: none"> ► Pull over and stop the vehicle safely as soon as possible, paying attention to road and traffic conditions. ► Secure the vehicle against rolling away (▷ page 140). ► Switch the ignition off. ► Open the front-passenger door. ► Remove the child and the child restraint system from the front-passenger seat. ► Make sure that there are no objects on the seat adding to the weight. <p>The system may otherwise detect the additional weight and interpret the seat occupant's weight as greater than it actually is.</p> <ul style="list-style-type: none"> ► Keep the seat unoccupied, close the front-passenger door and switch on the ignition. ► Observe the PASSENGER AIR BAG indicator lamps in the center console and the multifunction display and check the following: Seat unoccupied and ignition switched on: <ul style="list-style-type: none"> • a self-diagnosis is carried out. The PASSENGER AIR BAG OFF and PASSENGER AIR BAG ON indicator lamps must light up simultaneously for approximately six seconds • the PASSENGER AIR BAG OFF indicator lamp must then light up and remain lit after the self-diagnosis. If the indicator lamp is on, OCS has deactivated the front-passenger front air bag and front-passenger knee bag (▷ page 47) • The Front Passenger Airbag Enabled See Operator's Manual or Front Passenger Airbag Disabled See Operator's Manual display messages must not be shown in the multifunction display ► Wait for a period of at least 60 seconds until the necessary system checks have been completed. ► Make sure that the display messages do not appear in the multifunction display. <p>If these conditions are fulfilled, the front-passenger seat can be occupied again. Whether the PASSENGER AIR BAG OFF or ON indicator lamp remains lit or goes out depends on how OCS classifies the occupant.</p>









Display messages	Possible causes/consequences and ► Solutions
	<p>If the conditions are not fulfilled, the system is not operating correctly.</p> <p>► Visit a qualified specialist workshop immediately.</p> <p>For further information about the Occupant Classification System, see (▷ page 47).</p>

Lights

- i** Vehicles with LED bulbs in the light clusters:
 The display message for the corresponding lamp only appears when all of the LEDs in the lamp have failed.



Display messages	Possible causes/consequences and ► Solutions
 <p>Check Left Cornering Light or Check Right Cornering Light</p>	<p>The left or right-hand cornering light is defective.</p> <p>► Check whether you are permitted to replace the bulb yourself (▷ page 103).</p> <p>or</p> <p>► Visit a qualified specialist workshop.</p>
 <p>Check Left Low Beam or Check Right Low Beam</p>	<p>The left or right-hand low-beam headlamp is defective.</p> <p>► Check whether you are permitted to replace the bulb yourself (▷ page 103).</p> <p>or</p> <p>► Visit a qualified specialist workshop.</p>
 <p>Check Rear Left Turn Signal or Check Rear Right Turn Signal</p>	<p>The rear left-hand or rear right-hand turn signal is defective.</p> <p>► Check whether you are permitted to replace the bulb yourself (▷ page 103).</p> <p>or</p> <p>► Visit a qualified specialist workshop.</p>
 <p>Check Front Left Turn Signal or Check Front Right Turn Signal</p>	<p>The front left-hand or front right-hand turn signal is defective.</p> <p>► Check whether you are permitted to replace the bulb yourself (▷ page 103).</p> <p>or</p> <p>► Visit a qualified specialist workshop.</p>
 <p>Check Left Mirror Turn Signal or Check Right Mirror Turn Signal</p>	<p>The turn signal in the left-hand or right-hand exterior mirror is defective.</p> <p>► Visit a qualified specialist workshop.</p>
 <p>Check Center Brake Lamp</p>	<p>The high-mounted brake lamp is faulty.</p> <p>► Visit a qualified specialist workshop.</p>



Display messages	Possible causes/consequences and ► Solutions
 Check Left Brake Lamp or Check Right Brake Lamp	<p>The left or right-hand brake lamp is defective.</p> <ul style="list-style-type: none"> ► Check whether you are permitted to replace the bulb yourself (▷ page 103). <p>or</p> <ul style="list-style-type: none"> ► Visit a qualified specialist workshop.
 Check Left Tail and Brake Lamps or Check Right Tail and Brake Lamps	<p>The left or right-hand tail lamp/brake lamp is defective.</p> <ul style="list-style-type: none"> ► Check whether you are permitted to replace the bulb yourself (▷ page 103). <p>or</p> <ul style="list-style-type: none"> ► Visit a qualified specialist workshop.
 Check Left High Beam or Check Right High Beam	<p>The left or right-hand high beam is defective.</p> <ul style="list-style-type: none"> ► Check whether you are permitted to replace the bulb yourself (▷ page 103). <p>or</p> <ul style="list-style-type: none"> ► Visit a qualified specialist workshop.
 License Plate Lamp	<p>The left or right-hand license plate lamp is faulty.</p> <ul style="list-style-type: none"> ► Visit a qualified specialist workshop.
 Rear Fog Lamp	<p>The rear fog lamp is faulty.</p> <ul style="list-style-type: none"> ► Check whether you are permitted to replace the bulb yourself (▷ page 103). <p>or</p> <ul style="list-style-type: none"> ► Visit a qualified specialist workshop.
 Check Front Left Parking Lamp or Check Front Right Parking Lamp	<p>The front left or front right parking or standing lamp is defective.</p> <ul style="list-style-type: none"> ► Check whether you are permitted to replace the bulb yourself (▷ page 103). <p>or</p> <ul style="list-style-type: none"> ► Visit a qualified specialist workshop.
 Backup Light	<p>The backup lamp is defective.</p> <ul style="list-style-type: none"> ► Check whether you are permitted to replace the bulb yourself (▷ page 103). <p>or</p> <ul style="list-style-type: none"> ► Visit a qualified specialist workshop.
 Check Left Tail Lamp or Check Right Tail Lamp	<p>The left or right-hand tail lamp is defective.</p> <ul style="list-style-type: none"> ► Visit a qualified specialist workshop.







Display messages	Possible causes/consequences and ► Solutions
 <p>Check Front Left Sidemarker Lamp or Check Front Right Sidemarker Lamp</p>	<p>The front left-hand or front right-hand side marker lamp is faulty.</p> <p>► Visit a qualified specialist workshop.</p>
 <p>Check Rear Left Sidemarker Lamp or Check Rear Right Sidemarker Lamp</p>	<p>The rear left-hand or rear right-hand side marker lamp is faulty.</p> <p>► Visit a qualified specialist workshop.</p>
 <p>Check Left Daytime Running Light or Check Right Daytime Running Light</p>	<p>The left or right-hand daytime running lamp is faulty.</p> <p>► Check whether you are permitted to replace the bulb yourself (> page 103).</p> <p>or</p> <p>► Visit a qualified specialist workshop.</p>
 <p>Active Headlamps Inoperative</p>	<p>The active light function is faulty.</p> <p>► Visit a qualified specialist workshop.</p>
 <p>Malfunction See Operator's Manual</p>	<p>The exterior lighting is malfunctioning.</p> <p>► Visit a qualified specialist workshop.</p>
 <p>Auto Lamp Function Inoperative</p>	<p>The light sensor is defective.</p> <p>► Visit a qualified specialist workshop.</p>
 <p>Switch Off Lights</p>	<p>The lights are still switched on when you leave the vehicle. A warning tone also sounds.</p> <p>► Turn the light switch to the AUTO position.</p>
 <p>Switch On Headlamps</p>	<p>You are driving with low-beam headlamps switched off.</p> <p>► Turn the light switch to the  or AUTO position.</p>



Display messages	Possible causes/consequences and ► Solutions
Adaptive Highbeam Assist Currently Unavailable See Operator's Manual	<p>Adaptive Highbeam Assist is deactivated and temporarily inoperative. Possible causes are:</p> <ul style="list-style-type: none"> • the windshield in the camera's field of vision is dirty • visibility is impaired due to heavy rain, snow or fog <p>► Clean the windshield.</p> <p>If the system detects that the camera is fully operational again, the Adaptive Highbeam Assist Now Available message is displayed. Adaptive Highbeam Assist is operational again.</p>
Adaptive Highbeam Assist Inoperative	<p>Adaptive Highbeam Assist is faulty.</p> <p>► Visit a qualified specialist workshop.</p>

Engine

Display messages	Possible causes/consequences and ► Solutions
 <p>Check Coolant Level See Operator's Manual</p>	<p>The coolant level is too low.</p> <p>! Avoid making long journeys with too little coolant in the engine cooling system. The engine will otherwise be damaged.</p> <p>► Add coolant, observing the warning notes before doing so (► page 257).</p> <p>If you have to add coolant frequently:</p> <p>► Contact a qualified specialist workshop and have the engine cooling system checked.</p>
	<p>The fan motor is malfunctioning.</p> <p>► At coolant temperatures below 248 °F (120 °C), drive to the nearest qualified specialist workshop.</p> <p>► Avoid heavy loads on the engine as you do so, e.g. driving in mountainous terrain and stop-and-go traffic.</p>

Display messages	Possible causes/consequences and ► Solutions
 <p data-bbox="211 318 422 396">Coolant Too Hot Stop Vehicle Turn Engine Off</p>	<p data-bbox="471 265 744 324">The coolant is too hot. A warning tone also sounds.</p> <p data-bbox="481 336 632 369"> WARNING</p> <p data-bbox="471 378 1125 455">Do not drive when your engine is overheated. This can cause some fluids which may have leaked into the engine compartment to catch fire.</p> <p data-bbox="471 462 1125 512">Steam from the overheated engine can also cause serious burns which can occur just by opening the hood.</p> <p data-bbox="471 519 698 544">There is a risk of injury.</p> <ul style="list-style-type: none"> <li data-bbox="471 551 1125 602">► Pull over and stop the vehicle safely and switch off the engine, paying attention to road and traffic conditions. <li data-bbox="471 609 1008 634">► Secure the vehicle against rolling away (► page 140). <li data-bbox="471 641 865 666">► Wait until the engine has cooled down. <li data-bbox="471 673 1125 723">► Make sure that the air supply to the engine radiator is not blocked, e.g. by snow, slush or ice. <li data-bbox="471 731 1125 802">► Do not start the engine again until the display message goes out and the coolant temperature is below 248 °F (120 °C). Otherwise, the engine could be damaged. <li data-bbox="471 809 958 835">► Pay attention to the coolant temperature gauge. <p data-bbox="471 845 839 870">If the temperature increases again:</p> <ul style="list-style-type: none"> <li data-bbox="471 881 968 906">► Visit a qualified specialist workshop immediately. <p data-bbox="471 917 1102 967">Under normal operating conditions and with the specified coolant level, the coolant temperature may rise to 248 °F (120 °C).</p>
 <p data-bbox="211 1035 442 1085">See Operator's Manual</p>	<p data-bbox="471 987 790 1012">The battery is not being charged.</p> <p data-bbox="471 1019 744 1044">A warning tone also sounds.</p> <p data-bbox="471 1051 668 1076">Possible causes are:</p> <ul style="list-style-type: none"> <li data-bbox="481 1084 702 1109">• a defective alternator <li data-bbox="481 1116 663 1141">• a torn poly-V-belt <li data-bbox="481 1148 800 1173">• a malfunction in the electronics <p data-bbox="471 1184 1106 1209">! Do not continue driving. The engine could otherwise overheat.</p> <ul style="list-style-type: none"> <li data-bbox="471 1220 1125 1274">► Pull over and stop the vehicle safely and switch off the engine, paying attention to road and traffic conditions. <li data-bbox="471 1281 1008 1306">► Secure the vehicle against rolling away (► page 140). <li data-bbox="471 1313 876 1338">► Consult a qualified specialist workshop.

Display messages	Possible causes/consequences and ► Solutions
 <p>Stop Vehicle See Operator's Manual</p>	<p>The battery is no longer being charged and the battery charge level is too low. A warning tone also sounds.</p> <ul style="list-style-type: none"> ► Pull over and stop the vehicle safely and switch off the engine, paying attention to road and traffic conditions. ► Secure the vehicle against rolling away (▷ page 140). ► Observe the instructions in the display message  See Operator's Manual. ► Consult a qualified specialist workshop.
 <p>Check Engine Oil At Next Refueling</p>	<p>The engine oil level has dropped to the minimum level. A warning tone also sounds.</p> <p>! Avoid long journeys with too little engine oil. The engine will otherwise be damaged.</p> <ul style="list-style-type: none"> ► Check the oil level when next refueling, at the latest (▷ page 255). ► If necessary, add engine oil (▷ page 256). <p>If the engine oil needs topping up more often:</p> <ul style="list-style-type: none"> ► Contact a qualified specialist workshop and have the engine checked. <p>Information on approved engine oils can be obtained from any qualified specialist workshop or on the Internet at http://bevo.mercedes-benz.com.</p>
 <p>Fuel Level Low</p>	<p>The fuel level has dropped into the reserve range. ► Refuel at the nearest gas station.</p>
	<p>There is only a very small amount of fuel in the fuel tank. ► Refuel at the nearest gas station without fail.</p>
 <p>Gas Cap Loose</p>	<p>The fuel filler cap is not closed correctly or the fuel system is leaking. ► Check that the fuel filler cap is correctly closed.</p> <p>If the fuel filler cap is not correctly closed:</p> <ul style="list-style-type: none"> ► Close the fuel filler cap. <p>If the fuel filler cap is correctly closed:</p> <ul style="list-style-type: none"> ► Visit a qualified specialist workshop.



Driving systems	
Display messages	Possible causes/consequences and ► Solutions
 Attention Assist: Take a Break!	Based on certain criteria, ATTENTION ASSIST has detected fatigue or a lack of concentration on the part of the driver. A warning tone also sounds. <ul style="list-style-type: none"> ► If necessary, take a break. During long journeys, take regular breaks in good time so you get enough rest.
 Attention Assist Inoperative	ATTENTION ASSIST is inoperative. <ul style="list-style-type: none"> ► Visit a qualified specialist workshop.
 Off	The HOLD function is deactivated. the vehicle is skidding. A warning tone also sounds. <ul style="list-style-type: none"> ► Reactivate the HOLD function later (▷ page 156). The HOLD function is deactivated. When the brake pedal is firmly depressed, an activation condition is not fulfilled. A warning tone also sounds. <ul style="list-style-type: none"> ► Check the activation conditions for the HOLD function (▷ page 156).
Lane Keeping Assist Currently Unavailable See Operator's Manual	Lane Keeping Assist is deactivated and temporarily inoperative. Possible causes are: <ul style="list-style-type: none"> • the windshield in the camera's field of vision is dirty • visibility is impaired due to heavy rain, snow or fog • there have been no lane markings for an extended period • the lane markings are worn, dark or covered, e.g. by dirt or snow When the causes stated above no longer apply, the display message disappears. Lane Keeping Assist is operational again. If the display message does not disappear: <ul style="list-style-type: none"> ► Pull over and stop the vehicle safely as soon as possible, paying attention to road and traffic conditions. ► Secure the vehicle against rolling away (▷ page 140). ► Clean the windshield.
Lane Keeping Assist Inoperative	Lane Keeping Assist is faulty. <ul style="list-style-type: none"> ► Visit a qualified specialist workshop.

Display messages	Possible causes/consequences and ► Solutions
Blind Spot Assist Currently Unavailable See Operator's Manual	<p>Blind Spot Assist is temporarily inoperative.</p> <p>Possible causes are:</p> <ul style="list-style-type: none"> • the radar sensor system is temporarily inoperative, e.g. due to electromagnetic radiation emitted by nearby TV or radio stations or other sources of electromagnetic radiation • the radar sensor system is outside the operating temperature range <p>The yellow  indicator lamps also light up in the exterior mirrors. When the causes stated above no longer apply, the display message disappears.</p> <p>Blind Spot Assist is operational again.</p> <p>If the display message does not disappear:</p> <ul style="list-style-type: none"> ► Pull over and stop the vehicle safely as soon as possible, paying attention to road and traffic conditions. ► Secure the vehicle against rolling away (> page 140). ► Restart the engine.
Blind Spot Assist Inoperative	<p>Blind Spot Assist is faulty.</p> <p>The yellow  indicator lamps also light up in the exterior mirrors.</p> <ul style="list-style-type: none"> ► Visit a qualified specialist workshop.
Parking Pilot Canceled	<p>The driver's door is open and the driver's seat belt has not been fastened.</p> <ul style="list-style-type: none"> ► Repeat the parking process with the seat belt fastened and the driver's door closed. <p>You have inadvertently touched the multifunction steering wheel while steering intervention was active.</p> <ul style="list-style-type: none"> ► While steering intervention is active, make sure that the multifunction steering wheel is not touched unintentionally. <p>The vehicle has started to skid and ESP® has intervened.</p> <ul style="list-style-type: none"> ► Use Parking Pilot again later (> page 162).
Parking Pilot Inoperative	<p>You have just carried out a large number of turning or parking maneuvers.</p> <p>Parking Pilot will become available again after approximately ten minutes (> page 162).</p> <ul style="list-style-type: none"> ► Pull over and stop the vehicle safely as soon as possible, paying attention to road and traffic conditions. ► Switch off and restart the engine. <p>If the multifunction display still shows the display message:</p> <ul style="list-style-type: none"> ► Visit a qualified specialist workshop. <p>Parking Assist PARKTRONIC is malfunctioning.</p> <ul style="list-style-type: none"> ► Visit a qualified specialist workshop.

Display messages	Possible causes/consequences and ► Solutions
Parking Pilot Finished	The vehicle is parked. A warning tone also sounds. The display message disappears automatically.
Distance Pilot Off	Distance Pilot DISTRONIC is deactivated (▷ page 150). If it was not deactivated by the driver, a warning tone also sounds.
Distance Pilot Now Available	Distance Pilot DISTRONIC is operational again after having been temporarily unavailable. You can now reactivate Distance Pilot DISTRONIC (▷ page 150).
Distance Pilot Currently Unavailable See Operator's Manual	Distance Pilot DISTRONIC is temporarily inoperative. Possible causes are: <ul style="list-style-type: none"> • the radar sensor system is temporarily inoperative, e.g. due to electromagnetic radiation emitted by nearby TV or radio stations or other sources of electromagnetic radiation • the system is outside the operating temperature range • the on-board voltage is too low A warning tone also sounds. When the causes stated above no longer apply, the display message disappears. Distance Pilot DISTRONIC is operational again. If the display message does not disappear: <ul style="list-style-type: none"> ► Pull over and stop the vehicle safely as soon as possible, paying attention to road and traffic conditions. ► Secure the vehicle against rolling away (▷ page 140). ► Restart the engine.
Distance Pilot Inoperative	Distance Pilot DISTRONIC is malfunctioning. Situation-dependent parking assistance may also have failed. A warning tone also sounds. <ul style="list-style-type: none"> ► Visit a qualified specialist workshop.
Distance Pilot Suspended	You have depressed the accelerator pedal. Distance Pilot DISTRONIC is no longer controlling the speed of the vehicle. <ul style="list-style-type: none"> ► Remove your foot from the accelerator pedal.
Distance Pilot - - - mph	A condition for activating Distance Pilot DISTRONIC has not been met. <ul style="list-style-type: none"> ► Check the activation conditions for Distance Pilot DISTRONIC (▷ page 150).

Display messages	Possible causes/consequences and ► Solutions
Cruise Control Inoperative	<p>Cruise control is malfunctioning. A warning tone also sounds.</p> <p>► Visit a qualified specialist workshop.</p>
Cruise Control - - - mph	<ul style="list-style-type: none"> • A condition for activating cruise control has not been fulfilled. You have tried to store a speed below 20 mph (30 km/h), for example. • ESP® is deactivated. The yellow ESP® OFF warning lamp is lit. <p>► If conditions permit, drive faster than 20 mph (30 km/h) and store the speed.</p> <p>or</p> <p>► Check the activation conditions for cruise control (► page 148).</p> <p>or</p> <p>► Reactivate ESP® (► page 182).</p>



Tires	
Display messages	Possible causes/consequences and ► Solutions
Check Tire Pressure Soon	<p>Canada only:</p> <p>The tire pressure loss warning system has detected a significant loss in pressure.</p> <p>A warning tone also sounds.</p> <p>Possible causes:</p> <ul style="list-style-type: none"> • you have changed the positions of the wheels and tires or installed new wheels and tires • the tire pressure in one or more tires has dropped <p> WARNING</p> <p>Tire pressures that are too low pose the following hazards:</p> <ul style="list-style-type: none"> • they may burst, especially as the load and vehicle speed increase • they may wear excessively and/or unevenly, which may greatly impair tire traction. • the driving characteristics, as well as steering and braking, may be greatly impaired <p>There is a risk of an accident.</p> <ul style="list-style-type: none"> ► Stop the vehicle without making any sudden steering or braking maneuvers. Pay attention to the traffic conditions as you do so. ► Secure the vehicle against rolling away (▷ page 140). ► Check the tires and, if necessary, follow the instructions for a flat tire (▷ page 266). ► Check the tire pressures and, if necessary, correct the tire pressure. ► Restart the tire pressure loss warning system when the tire pressure is correct (▷ page 289).
Check Tire Pressure Then Restart Run Flat Indicator	<p>Canada only:</p> <p>The tire pressure loss warning system generated a display message and has not been restarted since.</p> <ul style="list-style-type: none"> ► Set the correct tire pressure in all four tires. ► Restart the tire pressure loss warning system (▷ page 289).
Run Flat Indicator Inoperative	<p>Canada only:</p> <p>The tire pressure loss warning system is faulty.</p> <ul style="list-style-type: none"> ► Visit a qualified specialist workshop.
Please Correct Tire Pressure	<p>USA only:</p> <p>The tire pressure is too low in at least one of the tires, or the tire pressure difference between the wheels is too great.</p> <ul style="list-style-type: none"> ► Check the tire pressures at the next opportunity (▷ page 289). ► If necessary, correct the tire pressure. ► Restart the tire pressure monitor (▷ page 291).



Display messages	Possible causes/consequences and ► Solutions
<p>Check Tires</p>	<p>USA only: The tire pressure in one or more tires has dropped significantly. The wheel position appears in the multifunction display. A warning tone also sounds.</p> <p> WARNING</p> <p>Tire pressures that are too low pose the following hazards:</p> <ul style="list-style-type: none"> • they may burst, especially as the load and vehicle speed increase • they may wear excessively and/or unevenly, which may greatly impair tire traction. • the driving characteristics, as well as steering and braking, may be greatly impaired <p>There is a risk of an accident.</p> <ul style="list-style-type: none"> ► Stop the vehicle without making any sudden steering or braking maneuvers. Pay attention to the traffic conditions as you do so. ► Secure the vehicle against rolling away (▷ page 140). ► Check the tires and, if necessary, follow the instructions for a flat tire (▷ page 266). ► Check the tire pressure (▷ page 289). ► If necessary, correct the tire pressure.
<p>Warning Tire Malfunction</p>	<p>USA only: The tire pressure in one or more tires has dropped suddenly. The wheel position appears in the multifunction display.</p> <p> WARNING</p> <p>Driving with a flat tire poses a risk of the following hazards:</p> <ul style="list-style-type: none"> • a flat tire affects the ability to steer or brake the vehicle • you could lose control of the vehicle • continued driving with a flat tire will cause excessive heat build-up and possibly a fire <p>There is a risk of an accident.</p> <ul style="list-style-type: none"> ► Stop the vehicle without making any sudden steering or braking maneuvers. Pay attention to the traffic conditions as you do so. ► Secure the vehicle against rolling away (▷ page 140). ► Check the tires and, if necessary, follow the instructions for a flat tire (▷ page 266).
<p>Tire Press. Monitor Currently Unavailable</p>	<p>USA only: Because there is interference from a strong source of radio waves, no signals from the tire pressure sensors are detected. The tire pressure monitor is temporarily malfunctioning.</p> <ul style="list-style-type: none"> ► Drive on. The tire pressure monitor restarts automatically as soon as the problem has been resolved.

Display messages	Possible causes/consequences and ► Solutions
TirePress. Sensor(s) Missing	<p>USA only:</p> <p>There is no signal from the tire pressure sensor of one or several wheels. The pressure of the affected tire does not appear in the multifunction display.</p> <ul style="list-style-type: none"> ► Have the faulty tire pressure sensor replaced at a qualified specialist workshop.
Tire Pressure Monitor Inoperative No Wheel Sensors	<p>USA only:</p> <p>The wheels mounted do not have a suitable tire pressure sensor. The tire pressure monitor is deactivated.</p> <ul style="list-style-type: none"> ► Mount wheels with suitable tire pressure sensors. The tire pressure monitor is activated automatically after driving for a few minutes.
Tire Press. Monitor Inoperative	<p>USA only:</p> <p>The tire pressure monitor is faulty.</p> <ul style="list-style-type: none"> ► Visit a qualified specialist workshop.



Vehicle	
Display messages	Possible causes/consequences and ► Solutions
Depress Brake to Start Engine	<p>You have attempted to start the engine with the transmission in position N without depressing the brake pedal.</p> <ul style="list-style-type: none"> ► Depress the brake pedal.
To Deselect P or N, Depress Brake and Start Engine	<p>You have attempted to shift the transmission to position R or D without starting the engine.</p> <ul style="list-style-type: none"> ► Start the engine. ► Depress the brake pedal. <p>i It is only possible to shift the transmission from position P to the desired position if you depress the brake pedal. Only then can the parking lock be deactivated. If you do not depress the brake pedal, the DIRECT SELECT lever can still be moved but the parking lock remains engaged.</p> <p>i At transmission fluid temperatures below -4 °F (-20 °C) you can only shift out of position P into another transmission position when the engine is running.</p>
Apply Brake to Shift from 'P'	<p>You have attempted to shift the transmission to position R, N or D without depressing the brake pedal.</p> <ul style="list-style-type: none"> ► Depress the brake pedal.







Display messages	Possible causes/consequences and ► Solutions
Transmission Not in P Risk of Vehicle Rolling Away	<p>The driver's door is open or not fully closed and the transmission is in position R, N or D. A warning tone also sounds.</p> <p> WARNING</p> <p>The vehicle may roll away. There is a risk of an accident.</p> <ul style="list-style-type: none"> ► Shift the transmission to position P. ► Secure the vehicle against rolling away (▷ page 140). ► Close the driver's door completely.
Service Required Do Not Shift Gears Visit Dealer	<p>You cannot change the transmission position due to a malfunction. A warning tone also sounds.</p> <p>If transmission position D is selected:</p> <ul style="list-style-type: none"> ► Drive to a qualified specialist workshop without shifting the transmission from position D. <p>If transmission position R, N or P is selected:</p> <ul style="list-style-type: none"> ► Secure the vehicle against rolling away (▷ page 140). ► Notify a qualified specialist workshop or breakdown service.
Only Shift to 'P' when Vehicle is Stationary	<p>The vehicle is moving.</p> <ul style="list-style-type: none"> ► Pull over and stop the vehicle safely as soon as possible, paying attention to road and traffic conditions. ► Shift the transmission to position P.
To Engage Transmiss. Position R First Depress the Brake	<p>You have attempted to shift from position D or N to transmission position R.</p> <ul style="list-style-type: none"> ► Shift the transmission to position R while depressing the brake pedal.
Reversing Not Possible Service Required	<p>The automatic transmission is malfunctioning. You cannot back up.</p> <ul style="list-style-type: none"> ► Visit a qualified specialist workshop.
Transmission Malfunction	<p>The automatic transmission is malfunctioning.</p> <ul style="list-style-type: none"> ► Visit a qualified specialist workshop.
Transmission Malfunction Stop	<p>The automatic transmission is malfunctioning.</p> <ul style="list-style-type: none"> ► Pull over and stop the vehicle safely as soon as possible, paying attention to road and traffic conditions. ► Secure the vehicle against rolling away (▷ page 140). ► Consult a qualified specialist workshop.

Display messages	Possible causes/consequences and ► Solutions
Stop Vehicle Shift to P Leave Engine Running	<p>The automatic transmission has overheated.</p> <ul style="list-style-type: none"> ► Drive on carefully. The automatic transmission is available again when the display message goes out. <p>If the multifunction display still shows the display message:</p> <ul style="list-style-type: none"> ► Pull over and stop the vehicle safely as soon as possible, paying attention to road and traffic conditions. ► Secure the vehicle against rolling away (▷ page 140). ► Wait until the automatic transmission has cooled down and the display message has disappeared.
Auxiliary Battery Malfunction	<p>The auxiliary battery for the automatic transmission is no longer being charged.</p> <ul style="list-style-type: none"> ► Visit a qualified specialist workshop. ► Until then, set the transmission to position P before you switch off the engine. ► Before leaving the vehicle, apply the electric parking brake.
Trans. Oil Overheated Drive on with Care	<p>Mercedes-AMG vehicles: the transmission oil has overheated. Manual drive program M and the temporarily active manual drive program are no longer available. The engine power output is reduced.</p> <ul style="list-style-type: none"> ► Allow the vehicle to cool down.
4matic Currently Unavailable	<p>4MATIC has overheated. The vehicle is only driven by the front wheels.</p> <ul style="list-style-type: none"> ► Drive on. The airflow cools 4MATIC more quickly. When the display message goes out, 4MATIC is available again and the vehicle is driven by all four wheels.
4matic Inoperative	<p>4MATIC is malfunctioning. The vehicle is only driven by the front wheels.</p> <ul style="list-style-type: none"> ► Visit a qualified specialist workshop.
	<p>The trunk lid is open.</p> <ul style="list-style-type: none"> ► Close the trunk lid.
	<p>The hood is open. A warning tone also sounds.</p> <p>⚠ WARNING</p> <p>The open hood may block your view when the vehicle is in motion. There is a risk of an accident.</p> <ul style="list-style-type: none"> ► Pull over and stop the vehicle safely as soon as possible, paying attention to road and traffic conditions. ► Secure the vehicle against rolling away (▷ page 140). ► Close the hood.

Display messages	Possible causes/consequences and ► Solutions
	At least one door is open. A warning tone also sounds. ► Close all the doors.
 Power Steering Malfunction See Operator's Manual	The power steering is malfunctioning. A warning tone also sounds. ⚠ WARNING You will need to use more force to steer. There is a risk of an accident. ► Check whether you are able to apply the extra force required. If you are able to steer safely: ► Drive on carefully. ► Visit a qualified specialist workshop immediately. If you are unable to steer safely: ► Do not drive on. ► Consult a qualified specialist workshop.
Phone No Service	Your vehicle is outside the network provider's transmitter/receiver range. ► Wait until the mobile phone operational readiness symbol appears in the multifunction display.
 Check Washer Fluid	The washer fluid level in the washer fluid reservoir has dropped below the minimum. ► Add washer fluid (▷ page 257).
Wiper Malfunctioning	The windshield wipers are malfunctioning. ► Visit a qualified specialist workshop.
Hazard Warning Flashers Malfunctioning	The hazard warning lamps are faulty. ► Visit a qualified specialist workshop.

SmartKey

Display messages	Possible causes/consequences and ► Solutions
 Key Does Not Belong to Vehicle	You have put the wrong SmartKey in the ignition lock. ► Use the correct SmartKey.
 Take Your Key from Ignition	The SmartKey is in the ignition lock. A warning tone sounds ► Remove the SmartKey.

Display messages	Possible causes/consequences and ► Solutions
 <p>Obtain a New Key</p>	<p>The SmartKey needs to be replaced.</p> <ul style="list-style-type: none"> ► Visit a qualified specialist workshop.
 <p>ReplacE Key Battery</p>	<p>The SmartKey battery is discharged.</p> <ul style="list-style-type: none"> ► Change the battery (► page 72).
 <p>Don't Forget Your Key</p>	<p>The display message is shown for a maximum of 60 seconds and is only a reminder.</p> <p>You have opened the driver's door with the engine switched off. The SmartKey is not in the ignition lock. A warning tone sounds.</p> <ul style="list-style-type: none"> ► Take the SmartKey with you when you leave the vehicle.
 <p>Key Not Detected (red display message)</p>	<p>The SmartKey is not in the vehicle.</p> <p>A warning tone also sounds.</p> <p>If the engine is switched off, you can no longer lock the vehicle centrally or start the engine.</p> <ul style="list-style-type: none"> ► Pull over and stop the vehicle safely as soon as possible, paying attention to road and traffic conditions. ► Secure the vehicle against rolling away (► page 140). ► Locate the SmartKey. <p>Because there is interference from a strong source of radio waves, the SmartKey is not detected whilst the engine is running.</p> <p>A warning tone also sounds.</p> <ul style="list-style-type: none"> ► Pull over and stop the vehicle safely as soon as possible, paying attention to road and traffic conditions. ► Secure the vehicle against rolling away (► page 140). ► Insert the SmartKey into the ignition lock and drive in SmartKey mode.
 <p>Key Not Detected (white display message)</p>	<p>The SmartKey is currently undetected.</p> <ul style="list-style-type: none"> ► Change the location of the SmartKey in the vehicle. <p>If the SmartKey still cannot be detected:</p> <ul style="list-style-type: none"> ► Operate the vehicle with the SmartKey in the ignition lock.
 <p>Remove 'Start' Button and Insert Key</p>	<p>The SmartKey is continually undetected.</p> <p>The SmartKey detection function has a temporary malfunction or is faulty. A warning tone also sounds.</p> <ul style="list-style-type: none"> ► Insert the SmartKey into the ignition lock and turn it to the desired position. ► Visit a qualified specialist workshop.

Warning and indicator lamps in the instrument cluster

General notes

Some systems carry out a self-diagnosis when the ignition is switched on. Therefore, some indicator and warning lamps may light up or flash temporarily. This behavior is non-critical.

These indicator and warning lamps only indicate a malfunction if they light up or flash after starting the engine or whilst driving.

Safety

Seat belts

Warning/
indicator
lamp

▷ Signal type

Possible causes/consequences and ► Solutions



▷ After starting the engine, the red seat belt warning lamp lights up for 6 seconds. The seat belt warning lamp reminds the driver and front passenger to fasten their seat belts.

- Fasten your seat belt (▷ page 43).



▷ After starting the engine, the red seat belt warning lamp lights up. In addition, a warning tone sounds for up to 6 seconds.

- The driver's seat belt is not fastened.
- Fasten your seat belt (▷ page 43).
The warning tone ceases.



▷ The red seat belt warning lamp lights up after the engine starts, as soon as the driver's or the front-passenger door is closed.

- The driver or front passenger has not fastened their seat belt.
- Fasten your seat belt (▷ page 43).
The warning lamp goes out.
- There are objects on the front-passenger seat.
- Remove the objects from the front-passenger seat and stow them in a secure place.
The warning lamp goes out.



▷ The red seat belt warning lamp flashes and an intermittent audible warning sounds.











The driver or front passenger has not fastened their seat belt. The vehicle is being driven faster than 15 mph (25 km/h) or has briefly been driven faster than 15 mph (25 km/h).

- Fasten your seat belt (▷ page 43).
The warning lamp goes out and the intermittent warning tone ceases.

There are objects on the front-passenger seat. The vehicle is being driven faster than 15 mph (25 km/h) or has briefly been driven faster than 15 mph (25 km/h).

- Remove the objects from the front-passenger seat and stow them in a secure place.
The warning lamp goes out and the intermittent warning tone ceases.

Safety systems

Warning/ indicator lamp	▷ Signal type Possible causes/consequences and ▶ Solutions
 	<p>▷  (USA only),  (Canada only): the red brake system warning lamp is lit while the engine is running. A warning tone also sounds.</p> <p> WARNING</p> <p>The brake boosting effect is malfunctioning and the braking characteristics may be affected.</p> <p>There is a risk of an accident.</p> <ul style="list-style-type: none"> ▶ Pull over and stop the vehicle safely as soon as possible, paying attention to road and traffic conditions. Do not continue driving under any circumstances. ▶ Secure the vehicle against rolling away (▷ page 140). ▶ Consult a qualified specialist workshop. ▶ Observe the additional display messages in the multifunction display.
 	<p>▷  (USA only),  (Canada only): the red brake system warning lamp is lit while the engine is running. A warning tone also sounds.</p> <p>There is not enough brake fluid in the brake fluid reservoir.</p> <p> WARNING</p> <p>The braking effect may be impaired.</p> <p>There is a risk of an accident.</p> <ul style="list-style-type: none"> ▶ Pull over and stop the vehicle safely as soon as possible, paying attention to road and traffic conditions. Do not continue driving under any circumstances. ▶ Secure the vehicle against rolling away (▷ page 140). ▶ Do not add brake fluid. Adding more will not correct the malfunction. ▶ Consult a qualified specialist workshop. ▶ Observe the additional display messages in the multifunction display.

Warning/
indicator
lamp

▷ Signal type

Possible causes/consequences and ► Solutions



▷ The yellow ABS warning lamp is lit while the engine is running.

ABS (Anti-lock Braking System) is deactivated due to a malfunction. BAS (Brake Assist), Active Brake Assist, ESP® (Electronic Stability Program), the HOLD function and hill start assist are also deactivated, for example.

ATTENTION ASSIST is deactivated.

 **WARNING**

The brake system continues to function normally, but without the functions listed above. The wheels could therefore lock if you brake hard, for example.

The steerability and braking characteristics may be severely affected. The braking distance in an emergency braking situation can increase.

If ESP® is not operational, ESP® is unable to stabilize the vehicle.

There is an increased risk of skidding and an accident.

- ▶ Observe the additional display messages in the multifunction display.
- ▶ Drive on carefully.
- ▶ Visit a qualified specialist workshop immediately.

If the ABS control unit is faulty, there is also a possibility that other systems, such as the navigation system or the automatic transmission, will not be available.



▷ The yellow ABS warning lamp is lit while the engine is running.

ABS is temporarily unavailable. BAS, Active Brake Assist, ESP®, EBD (Electronic Brake-force Distribution), the HOLD function and hill start assist are also deactivated, for example.

Possible causes are:

- Self-diagnosis is not yet complete.
- The on-board voltage may be insufficient.

ATTENTION ASSIST is deactivated.

 **WARNING**

The brake system continues to function normally, but without the functions listed above. The front and rear wheels could therefore lock if you brake hard, for example.

The steerability and braking characteristics may be severely affected. The braking distance in an emergency braking situation can increase.

If ESP® is not operational, ESP® is unable to stabilize the vehicle.

There is a risk of an accident.

- ▶ Carefully drive a suitable distance, making slight steering movements at a speed above 12 mph (20 km/h).
The functions mentioned above are available again when the warning lamp goes out.

If the warning lamp is still on:

- ▶ Observe the additional display messages in the multifunction display.
- ▶ Drive on carefully.
- ▶ Visit a qualified specialist workshop immediately.

Warning/
indicator
lamp

▷ Signal type

Possible causes/consequences and ► Solutions



▷ The yellow ABS warning lamp is lit while the engine is running. A warning tone also sounds.

EBD is malfunctioning. ABS, BAS, Active Brake Assist, ESP®, the HOLD function and hill start assist, for example, are also unavailable.

ATTENTION ASSIST is deactivated.

WARNING

The brake system continues to function normally, but without the functions listed above. The front and rear wheels could therefore lock if you brake hard, for example.

The steerability and braking characteristics may be severely affected. The braking distance in an emergency braking situation can increase.

If ESP® is not operational, ESP® is unable to stabilize the vehicle.

There is an increased risk of skidding and an accident.

- ▶ Observe the additional display messages in the multifunction display.
- ▶ Drive on carefully.
- ▶ Visit a qualified specialist workshop immediately.

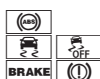

▷ **BRAKE** (USA only), (Canada only): the red brake system warning lamp and the yellow ABS, ESP® and ESP® OFF warning lamps are lit while the engine is running.

ABS and ESP® are malfunctioning. BAS, Active Brake Assist, EBD, the HOLD function and hill start assist, for example, are also unavailable.

ATTENTION ASSIST is deactivated.

WARNING

The brake system continues to function normally, but without the functions listed above. The front and rear wheels could therefore lock if you brake hard, for example.

The steerability and braking characteristics may be severely affected. The braking distance in an emergency braking situation can increase.

If ESP® is not operational, ESP® is unable to stabilize the vehicle.

There is an increased risk of skidding and an accident.

- ▶ Observe the additional display messages in the multifunction display.
- ▶ Drive on carefully.
- ▶ Visit a qualified specialist workshop immediately.

**Warning/
indicator
lamp****▷ Signal type****Possible causes/consequences and ► Solutions**

- ▷ The yellow ESP[®] warning lamp flashes while the vehicle is in motion. ESP[®] or traction control has intervened because there is a risk of skidding or at least one wheel has started to spin. Cruise control or Distance Pilot DISTRONIC is deactivated.
- ▶ When pulling away, only depress the accelerator pedal as far as necessary.
 - ▶ Ease off the accelerator pedal while the vehicle is in motion.
 - ▶ Adapt your driving style to suit the road and weather conditions.
 - ▶ Do not deactivate ESP[®].
In rare cases (▷ page 65) , it may be best to deactivate ESP[®].
Observe the important safety notes on ESP[®] (▷ page 63).



- ▷ The yellow ESP[®] OFF warning lamp is lit while the engine is running. ESP[®] is deactivated. ESP[®] will not stabilize the vehicle if it starts to skid or if a wheel starts to spin.

⚠ WARNING

If ESP[®] is switched off, ESP[®] is unable to stabilize the vehicle. Further driving systems or driving safety systems are thus restricted. There is an increased risk of skidding and an accident.

- ▶ Reactivate ESP[®].
In rare cases (▷ page 65) , it may be best to deactivate ESP[®].
Observe the important safety notes on ESP[®] (▷ page 63).
 - ▶ Adapt your driving style to suit the road and weather conditions.
- If ESP[®] cannot be activated:
- ▶ Drive on carefully.
 - ▶ Contact a qualified specialist workshop and have ESP[®] checked.



- ▷ Mercedes-AMG vehicles only:
The yellow SPORT handling mode warning lamp is lit while the engine is running. SPORT handling mode is activated.

⚠ WARNING

When SPORT handling mode is switched on, ESP[®] is unable to stabilize the vehicle. There is an increased risk of skidding and an accident.

- ▶ Only switch to SPORT handling mode in accordance with the conditions described in the "Activating/deactivating ESP[®]" section (▷ page 65).

**Warning/
indicator
lamp****▷ Signal type****Possible causes/consequences and ▶ Solutions**

▷ The yellow ESP[®] and ESP[®] OFF warning lamps are lit while the engine is running. ESP[®], BAS, Active Brake Assist, the HOLD function and hill start assist are not available due to a malfunction.

ATTENTION ASSIST is deactivated.

WARNING

The brake system continues to function normally, but without the functions listed above.

The braking distance in an emergency braking situation can thus increase.

If ESP[®] is not operational, ESP[®] is unable to stabilize the vehicle.

There is an increased risk of skidding and an accident.

- ▶ Observe the additional display messages in the multifunction display.
- ▶ Drive on carefully.
- ▶ Visit a qualified specialist workshop immediately.



▷ The yellow ESP[®] and ESP[®] OFF warning lamps are lit while the engine is running. ESP[®], BAS, the HOLD function and hill start assist are temporarily unavailable.

Adaptive Brake Assist may also have failed.

ATTENTION ASSIST is deactivated.

Self-diagnosis is not yet complete.

WARNING

The brake system continues to function normally, but without the functions listed above.

The braking distance in an emergency braking situation can thus increase.

If ESP[®] is not operational, ESP[®] is unable to stabilize the vehicle.

There is an increased risk of skidding and an accident.

- ▶ Carefully drive a suitable distance, making slight steering movements at a speed above 12 mph (20 km/h).
The functions mentioned above are available again when the warning lamp goes out.

If the warning lamp is still on:

- ▶ Observe the additional display messages in the multifunction display.
- ▶ Drive on carefully.
- ▶ Visit a qualified specialist workshop immediately.

**Warning/
indicator
lamp****▷ Signal type****Possible causes/consequences and ► Solutions**

▷ **PARK** (USA only),  (Canada only): the red indicator lamp for the electric parking brake flashes or lights up and/or the yellow warning lamp for the electric parking brake lights up.

► Observe the additional display messages in the multifunction display.



▷ The red restraint system warning lamp is lit while the engine is running. The restraint system is malfunctioning.

⚠ WARNING

The air bags or Emergency Tensioning Devices may either be triggered unintentionally or, in the event of an accident, may not be triggered.

There is an increased risk of injury.

- Observe the additional display messages in the multifunction display.
- Drive on carefully.
- Contact a qualified specialist workshop and have the restraint system checked.

For further information about the restraint system, see (▷ page 39).

Engine**Warning/
indicator
lamp****▷ Signal type****Possible causes/consequences and ► Solutions**

▷ The yellow Check Engine warning lamp lights up while the engine is running. There may be a malfunction, for example:

- in the engine management
- in the fuel injection system
- in the exhaust system
- in the ignition system
- in the fuel system

The emission limit values may be exceeded and the engine may be in emergency mode.

► Visit a qualified specialist workshop immediately.

i In some states, you must immediately visit a qualified specialist workshop as soon as the yellow Check Engine warning lamp lights up. This is due to the legal requirements in effect in these states. If in doubt, check whether such legal regulations apply in the state in which you are currently driving.



▷ The yellow reserve fuel warning lamp lights up while the engine is running. The fuel level has dropped into the reserve range.

► Refuel at the nearest gas station.

**Warning/
indicator
lamp****▷ Signal type****Possible causes/consequences and ▶ Solutions**

▷ The yellow reserve fuel warning lamp flashes while the vehicle is in motion. In addition, the  Check Engine warning lamp may light up.

The fuel filler cap is not closed correctly or the fuel system is leaking.

▶ Check that the fuel filler cap is correctly closed.

▶ **If the fuel filler cap is not correctly closed:** close the fuel filler cap.

▶ **If the fuel filler cap is closed:** visit a qualified specialist workshop.



▷ The red coolant warning lamp lights up while the engine is running and the coolant temperature gauge is at the start of the scale.

The temperature sensor for the coolant temperature gauge is malfunctioning.

The coolant temperature is no longer being monitored. There is a risk of engine damage if the coolant temperature is too high.

▶ Pull over and stop the vehicle safely and switch off the engine, paying attention to road and traffic conditions. Do not continue driving under any circumstances.

▶ Secure the vehicle against rolling away (▷ page 140).

▶ Consult a qualified specialist workshop.

Warning/
indicator
lamp

▷ Signal type

Possible causes/consequences and ▶ Solutions



▷ The red coolant warning lamp comes on while the engine is running.

The coolant level is too low.

If the coolant level is correct, the airflow to the engine radiator may be blocked or the electric engine radiator fan may be defective.

The coolant is too hot and the engine is no longer being cooled sufficiently.

- ▶ Observe the additional display messages in the multifunction display.
- ▶ Pull over and stop the vehicle safely and switch off the engine, paying attention to road and traffic conditions.
- ▶ Secure the vehicle against rolling away (▷ page 140).
- ▶ Leave the vehicle and keep a safe distance from the vehicle until the engine has cooled down.
- ▶ Check the coolant level and add coolant, observing the warning notes (▷ page 257).
- ▶ If you have to add coolant frequently, have the engine cooling system checked.
- ▶ Make sure that the air supply to the engine radiator is not blocked, e.g. by snow, slush or ice.
- ▶ Do not start the engine again until the coolant temperature is below 248 °F (120 °C). Otherwise, the engine could be damaged.
- ▶ Drive to the nearest qualified specialist workshop.
- ▶ Avoid heavy loads on the engine as you do so, e.g. driving in mountainous terrain and stop-and-go traffic.



▷ The red coolant warning lamp comes on while the engine is running. A warning tone also sounds.

The coolant temperature has exceeded 248 °F (120 °C). The airflow to the engine radiator may be blocked or the coolant level may be too low.

WARNING

The engine is not being cooled sufficiently and may be damaged.

Do not drive when your engine is overheated. This can cause some fluids which may have leaked into the engine compartment to catch fire.

Steam from the overheated engine can also cause serious burns which can occur just by opening the hood.

There is a risk of injury.

- ▶ Observe the additional display messages in the multifunction display.
- ▶ Pull over and stop the vehicle safely and switch off the engine, paying attention to road and traffic conditions.
- ▶ Secure the vehicle against rolling away (▷ page 140).
- ▶ Leave the vehicle and keep a safe distance from the vehicle until the engine has cooled down.
- ▶ Check the coolant level and add coolant, observing the warning notes (▷ page 257).
- ▶ If you have to add coolant frequently, have the engine cooling system checked.
- ▶ Make sure that the air supply to the engine radiator is not blocked, e.g. by snow, slush or ice.

**Warning/
indicator
lamp**▷ **Signal type****Possible causes/consequences and ▶ Solutions**

- ▶ At coolant temperatures below 248 °F (120 °C), drive to the nearest qualified specialist workshop.
- ▶ Avoid heavy loads on the engine as you do so, e.g. driving in mountainous terrain and stop-and-go traffic.

Driving systems**Warning/
indicator
lamp**▷ **Signal type****Possible causes/consequences and ▶ Solutions**

▷ The red distance warning lamp lights up while the vehicle is in motion. A warning tone also sounds.

You are approaching a vehicle or a stationary obstacle in your line of travel at too high a speed.

- ▶ Be prepared to brake immediately.
- ▶ Pay careful attention to the traffic situation. You may have to brake or take evasive action.

Further information on the distance warning function of Active Brake Assist (▷ page 61).

Tires

Warning/
indicator
lamp

▷ Signal type

Possible causes/consequences and ► Solutions



▷ The yellow tire pressure monitor warning lamp (pressure loss/malfunction) is lit. The tire pressure monitor has detected a loss of pressure in at least one of the tires.

WARNING

Tire pressures that are too low pose the following hazards:

- they may burst, especially as the load and vehicle speed increase
 - they may wear excessively and/or unevenly, which may greatly impair tire traction.
 - the driving characteristics, as well as steering and braking, may be greatly impaired
There is a risk of an accident.
- Stop the vehicle without making any sudden steering or braking maneuvers. Pay attention to the traffic conditions as you do so.
- Secure the vehicle against rolling away (▷ page 140).
- Observe the additional display messages in the multifunction display.
- Check the tires and, if necessary, follow the instructions for a flat tire (▷ page 266).
- Check the tire pressure (▷ page 289).
- If necessary, correct the tire pressure.



▷ The yellow tire pressure monitor warning lamp (pressure loss/malfunction) flashes for approximately one minute and then remains lit.

The tire pressure monitor is faulty.

WARNING

The system is possibly unable to recognize or register low tire pressure. There is a risk of an accident.

- Observe the additional display messages in the multifunction display.
- Visit a qualified specialist workshop immediately.

General notes

The multimedia system section in this Operator's Manual describes the basic principles for operation. More information can be found in the Digital Operator's Manual.

Important safety notes

WARNING

If you operate information systems and communication equipment integrated in the vehicle while driving, you will be distracted from traffic conditions. You could also lose control of the vehicle. There is a risk of an accident.

Only operate the equipment when the traffic situation permits. If you are not sure that this is possible, park the vehicle paying attention to traffic conditions and operate the equipment when the vehicle is stationary.

You must observe the legal requirements for the country in which you are currently driving when operating the multimedia system.

The multimedia system calculates the route to the destination without taking the following into account, for example:

- traffic lights
- stop and yield signs
- parking or stopping restrictions
- road narrowing
- other road and traffic rules and regulations

The multimedia system may give incorrect navigation recommendations if the actual street/traffic situation does not correspond with the digital map's data.

For example:

- a diverted route
- the road layout or the direction of a one-way street has been changed

For this reason, you must always observe road and traffic rules and regulations during your journey. Road and traffic rules and regulations always have priority over multimedia system driving recommendations.

Navigation announcements are intended to direct you while driving without diverting your attention from the road and driving.

Please always use this feature instead of consulting the map display for directions. Looking at the icons or map display can distract you from traffic conditions and driving, and increase the risk of an accident.

This equipment complies with FCC radiation exposure limits set forth for uncontrolled equipment and meets the FCC radio frequency (RF) Exposure Guidelines in Supplement C to OET65.

This equipment has very low levels of RF energy that is deemed to comply without maximum permissive exposure evaluation (MPE). However, it is recommended to install it at a distance of at least 8 inches (approx. 20 cm) between the radiation source and a person's body (not including limbs such as hands, wrists, feet and legs).

WARNING

Modifications to electronic components, their software as well as wiring can impair their function and/or the function of other networked components. In particular, systems relevant to safety could also be affected. As a result, these may no longer function as intended and/or jeopardize the operating safety of the vehicle. There is an increased risk of an accident and injury.

Never tamper with the wiring as well as electronic components or their software. You should have all work to electrical and electronic equipment carried out at a qualified specialist workshop.

If you make any changes to the vehicle electronics, the general operating permit is rendered invalid.

Function restrictions

For safety reasons, some functions are restricted or unavailable while the vehicle is in motion. You will notice this, for example, because either you will not be able to select certain menu items or a message will appear to this effect.

Operating system

Overview

General notes

! Do not use the space in front of the display for storage. Objects placed here could damage the display or impair its function. Avoid any direct contact with the display surface. Pressure on the display surface may result in impairments to the display, which could be irreversible.

Wearing polarized sunglasses may impair your ability to read the display.

The display has an automatic temperature-controlled switch-off feature. The brightness is automatically reduced if the temperature is too high. The display may temporarily switch off completely.

Cleaning instructions

! Do not touch the display. The display has a very sensitive high-gloss surface; there is a risk of scratching. If you have to clean the screen, however, use a mild cleaning agent and a soft, lint-free cloth.

The display must be switched off and have cooled down before you start cleaning. Do not apply pressure to the display surface when cleaning it, as this could cause irreversible damage to the display.

Switching the multimedia system on/off

► Press the  control knob.



Adjusting the volume

► Turn the  control knob.

The volume is adjusted:

- for the currently selected media source
- during traffic or navigation announcements
- in hands-free mode during a phone call

Switching the sound on or off

► Press the  button on the control panel. If the audio output is switched off, the status line will show the  symbol. If you switch

the media source or set the volume, the sound is automatically switched on.

i Navigation announcements will be heard even if the sound is muted.

Functions

The multimedia system has the following functions:





- Radio mode
- Media mode with media search
- Sound systems
- Navigation system
 - COMAND: navigation via the hard drive
 - Audio 20: navigation via SD card
- Communication functions
- SIRIUS Weather (COMAND)
- Vehicle functions with system settings
- Favorites functions

Controller

The controller in the center console lets you:

- select menu items on the display
- enter characters
- select a destination on the map
- save entries

The controller can be:

- turned 
- slid left or right 
- slid forwards or back 
- slid diagonally 
- pressed briefly or pressed and held 

Back button

You can use the  button to exit a menu or to call up the basic display of the current operating mode.



► **To exit the menu:** briefly press the  button.

The multimedia system changes to the next higher menu level in the current operating mode.

► **To call up the basic display:** press the  button for longer than two seconds. The multimedia system changes to the basic display of the current operating mode.

Favorites



Calling up and exiting favorites

- ▶ **To call up:** press the  button on the controller.
- ▶ Select a favorite, e.g. **Vehicle**.
The favorites are displayed.
- ▶ **To exit:** press the  button again.

Adding favorites

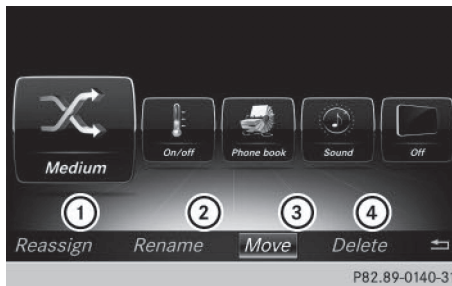
Adding a predefined favorite



- ① Adds a new favorite
 - ② Renames a selected favorite
 - ③ Moves a selected favorite
 - ④ Deletes a selected favorite
- ▶ Press the  button.
 - ▶ Slide  the controller.
The menu bar is shown.
 - ▶ Select **Reassign**.
The categories are displayed.
 - ▶ Select a category.
The favorites are displayed.
 - ▶ Select a favorite.
 - ▶ Add a favorite at the desired position.
If a favorite has already been added at this position, it will be overwritten.

Adding your own favorite

- ▶ Select **Vehicle** → **Climate Control**.
- ▶ Press and hold the  button until the favorites are displayed.
- ▶ Add a favorite at the desired position.
If a favorite has already been added at this position, it will be overwritten.

Navigation mode

Important safety notes

WARNING

If you operate information systems and communication equipment integrated in the vehicle while driving, you will be distracted from traffic conditions. You could also lose control of the vehicle. There is a risk of an accident.

Only operate the equipment when the traffic situation permits. If you are not sure that this is possible, park the vehicle paying attention to traffic conditions and operate the equipment when the vehicle is stationary.

You must observe the legal requirements for the country in which you are currently driving when operating the navigation system.

General notes

Among other things, correct functioning of the navigation system depends on GPS reception. In certain situations, GPS reception may be impaired, there may be interference or there may be no reception at all, e.g. in tunnels or parking garages.

Audio 20 is equipped with Garmin® MAP PILOT (see the manufacturer's operating instructions). The Garmin® MAP PILOT operating instructions are stored on the SD card as a PDF file. The SD card box contains a quick guide.

The following descriptions apply to navigation with COMAND. Further information can be found in the Digital Operator's Manual.

Selecting a route type and route options

Multimedia system:

- ▶ Select **Navi** → **Navigation**.
The map shows the vehicle's current position.
- ▶ Slide  the controller.
- ▶ Select **Options** → **Route Settings**.

Notes for route types:

- **Eco Route**
- **Dynamic Traffic Route**

Traffic reports on the route for the route guidance are taken into account (not available in all countries).

- **Dynamic TRF. Route After Request**
You can decide whether or not current traffic reports should be included in the route calculation (not available in all countries).
- **Calculate Alternative Routes**
Different routes are being calculated. In order to do so, instead of **Start**, select the menu item **Continue**.
- ▶ **To avoid/use route options:** select **Avoid Options**.
- ▶ Select a route option.

Notes for route options:



- **Use Toll Roads**
The route calculation includes roads which require you to pay a usage fee (toll).
- **Number of Occupants in the Vehicle:** (only available in the USA)
Prerequisite: your vehicle meets the access conditions for carpool lanes.
Carpool lanes will be included if the carpool lanes option is activated.

Entering an address

Multimedia system:

- ▶ Select **Navi** → **Navigation**.
The map shows the vehicle's current position.
- ▶ Slide  the controller.
- ▶ Select **Destination** → **Address Entry**.

Enter an address, e.g. as follows:

- city or ZIP code, street, house number
- state/province, city or ZIP code
- city or ZIP code, center
- street, city or ZIP code, intersection
- ▶ Select **City**.
The city in which the vehicle is currently located (current vehicle position) is at the top. Below this, you will see locations for which route guidance has already been carried out.
- ▶ Enter the city.
The  symbol: the location is contained on the digital map multiple times.
- ▶ **To switch to the list:** slide the  controller.
- ▶ Select the location.
If available, the ZIP code is shown. If there are different ZIP codes available for the location,

the corresponding digits are displayed with an **X**.

- ▶ Enter the street and house number.
The address is in the menu.

Further options for destination entry:

- search for a keyword
The keyword search finds destinations using fragments of words.
- select the last destination
- select a contact
- select a POI
You can search for a POI by location, name or telephone number.
- select destination on the map
- enter intermediate destination
You can map the route to the destination yourself with up to four intermediate destinations.
- select destinations from Mercedes-Benz Apps
- select geo-coordinates

Calculating the route

Prerequisite: the address has been entered and is in the menu.

- ▶ Select **Start** or **Continue**.
The route is calculated with the selected route type and the selected route options.
If route guidance has already been activated, a prompt will appear asking whether you wish to end the current route guidance.
- ▶ Select **Cancel Active Route Guidance** or **Set as Intermediate Destination**.
Cancel Active Route Guidance cancels the current route guidance and starts route calculation to the new destination.
Set as Intermediate Destination adds the new destination in addition to the existing destination and opens the intermediate destinations list.

Connecting a mobile phone

Prerequisites

For telephony via the Bluetooth® interface, you require a Bluetooth®-capable mobile phone. The mobile phone must support Hands-Free Profile 1.0 or above.

Multimedia system:

- ▶ Select **Vehicle** → **System Settings** → **Activate Bluetooth**.
- ▶ Activate Bluetooth® .

Mobile phone:

- ▶ Activate Bluetooth® and, if necessary, Bluetooth® visibility for other devices (see the manufacturer's operating instructions).

The Bluetooth® device names for all of one manufacturer's products might be identical. To make it possible to clearly identify your mobile phone, change the device name (see the manufacturer's operating instructions).

If the mobile phone supports the PBAP (Phone Book Access Profile) and MAP (Message Access Profile) Bluetooth® profiles, the following information will be transmitted after you connect:

- Phone book
- Call lists
- Text messages and e-mail

i Further information on suitable mobile phones can be found at: <http://www.mercedes-benz.com/connect>

i In the USA, you can get in touch with the Mercedes-Benz Customer Assistance Center on 1-800-FOR-MERCEdes (1-800-367-6372). In Canada, you can get in touch with the Customer Relations Center on 1-800-387-0100.

Searching for and authorizing (connecting) a mobile phone

Before using your mobile phone with the multimedia system for the first time, you will need to search for the phone and then authorize (connect) it. Depending on the mobile phone, authorization either takes place by means of Secure Simple Pairing or by entering a passkey. The multimedia system automatically makes the procedure that is relevant for your mobile phone available. The mobile phone is always connected automatically after authorization. Further information on using a mobile phone with the multimedia system (see the Digital Operator's Manual).

If the multimedia system does not detect your mobile phone, this may be due to particular security settings on your mobile phone (see the manufacturer's operating instructions).

Only one mobile phone can be connected to the multimedia system at any one time.



Searching for a mobile phone

Multimedia system:

- ▶ Select **Tel/**  → **Connect Device** → **Search for Phones** → **Start Search**.

The available mobile phones are displayed.

Symbols in the device list

Symbol	Explanation
	New mobile phone found, not yet authorized.
	Mobile phone is authorized, but is not connected
•	Mobile phone is authorized and connected

Connecting a mobile phone

Authorization using Secure Simple Pairing:

- ▶ Select mobile phone.
A code is displayed in the multimedia system and on the mobile phone.
- ▶ **If codes match:** select **Yes** on the multimedia system.
- ▶ Confirm code on the mobile phone. Depending on the mobile phone used, confirm the connection to the multimedia system and for the PBAP and MAP Bluetooth® profiles. The prompt to confirm may take up to two minutes to be displayed (see the manufacturer's operating instructions).
- ▶ **If the codes are different:** select **No** on the multimedia system.
The process is canceled.
Repeat authorization.

Authorization by entering a passkey (passcode):

- ▶ Select the Bluetooth® name of the mobile phone.
The input menu for the passkey is displayed.
- ▶ Choose a one to sixteen-digit number combination as a passkey.
- ▶ Enter the passkey on the multimedia system.
- ▶ Press to confirm.
- ▶ Enter and confirm the passkey on the mobile phone. Depending on the mobile phone used, confirm the connection to the multimedia sys-

tem and for the PBAP and MAP Bluetooth® profiles. The prompt to confirm may take up to two minutes to be displayed (see the manufacturer's operating instructions).

Switching between mobile phones

If you have authorized more than one mobile phone, you can switch between the individual phones.

Multimedia system:

- ▶ Select **Connect Device**.
- ▶ Select a mobile phone from the device list.

Media mode

General notes

If you wish to play external media sources, the default display must already be turned on. Further information on media mode (see the Digital Operator's Manual).

The following external media sources can be used:

- Apple® devices (e.g. iPhone®)
- USB devices (e.g. USB stick, MP3 player) (▷ page 232)
- CD
- DVD (COMAND)
- SD cards
- via devices connected by Bluetooth®

i Information on single CD/DVD drive or DVD changer (see the Digital Operator's Manual).

Using the device list

Multimedia system:

- ▶ Select **Media** → **Devices**.
The available media sources will be shown. The • dot indicates the current setting.
- ▶ Select the media source.
Playable files are played.

Inserting/removing an SD card

Important safety notes

⚠ WARNING

SD cards are small parts. They can be swallowed and cause choking. This poses an increased risk of injury or even fatal injury.

Keep the SD card out of the reach of children. If a SD card is swallowed, seek medical attention immediately.

! If you are no longer using the SD card, you should remove it and store it outside the vehicle. High temperatures can damage the card.

Inserting an SD card

The SD card slot is on the control panel.

- ▶ Insert the SD card into the SD card slot until the SD card engages. The side with the contacts must face downwards.

Removing an SD card

- ▶ Press the SD card.
The SD card is ejected.
- ▶ Remove the SD card.

Connecting USB devices



There are two USB ports in the stowage space under the armrest.

- ▶ Connect the USB device to the USB port.
- ▶ Select the media source (▷ page 232).

Loading guidelines

WARNING

If objects, luggage or loads are not secured or not secured sufficiently, they could slip, tip over or be flung around and thereby hit vehicle occupants. There is a risk of injury, particularly in the event of sudden braking or a sudden change in direction.

Always store objects so that they cannot be flung around. Secure objects, luggage or loads against slipping or tipping before the journey.

WARNING

Combustion engines emit poisonous exhaust gases such as carbon monoxide. Exhaust gases can enter the vehicle interior if the trunk lid is open when the engine is running, especially if the vehicle is in motion. There is a risk of poisoning.

Always switch off the engine before opening the trunk lid. Never drive with the trunk lid open.

WARNING

The exhaust tail pipe and tail pipe trim can become very hot. If you come into contact with these parts of the vehicle, you could burn yourself. There is a risk of injury.

Always be particularly careful around the exhaust tail pipe and the tail pipe trim. Allow these components to cool down before touching them.

The handling characteristics of a laden vehicle are dependent on the distribution of the load within the vehicle.

Observe the following notes on loading and transporting a load:

- Never exceed the maximum permissible gross vehicle mass or the gross axle weight rating for the vehicle (including occupants). The values are specified on the vehicle iden-

tification plate on the B-pillar of the driver's door.

- The trunk is the preferred place to carry objects.
- Position heavy loads as far forwards as possible and as low down in the trunk as possible.
- The load must not protrude above the upper edge of the seat backrests.
- Always place the load against the rear or front seat backrests. Make sure that the seat backrests are securely locked into place.
- Always place the load behind unoccupied seats if possible.
- Use the cargo tie-down rings and the parcel nets to transport loads and luggage.
- Use cargo tie-down rings and fastening materials appropriate for the weight and size of the load.
- Secure the load with sufficiently strong and wear-resistant tie-downs. Pad sharp edges for protection.

Stowage areas

Stowage spaces

Important safety notes

WARNING

If objects in the passenger compartment are stowed incorrectly, they can slide or be thrown around and hit vehicle occupants. In addition, cupholders, open stowage spaces and mobile phone brackets cannot always retain all objects they contain. There is a risk of injury, particularly in the event of sudden braking or a sudden change in direction.

- Always stow objects so that they cannot be thrown around in such situations.
- Always make sure that objects do not protrude from stowage spaces, parcel nets or stowage nets.
- Close the lockable stowage spaces before starting a journey.
- Always stow and secure heavy, hard, pointed, sharp-edged, fragile or bulky objects in the trunk.

Observe the loading guidelines (▷ page 233).

Stowage compartments in the front

Glove box

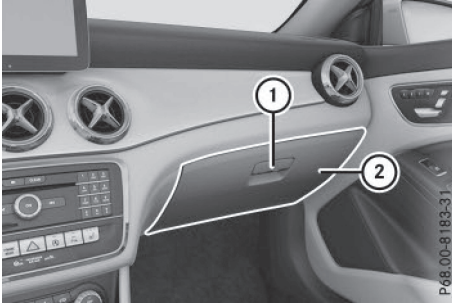

- ▶ **To open:** pull handle ① and open glove box flap ②.
- ▶ **To close:** fold glove box flap ② upwards until it engages.

There is a pen holder at the top of the glove box flap.

Eyeglasses compartment



- ▶ **To open:** press marking ①.

Make sure that the eyeglasses compartment is always closed while the vehicle is in motion.

Stowage compartment in the front center console



- ▶ **To open:** press the marking on cover ①.
- ⓘ Depending on the vehicle equipment, there may be an ashtray in the center console instead of a storage compartment.

Stowage compartment in front of the armrest (vehicles with automatic transmission)



- ▶ **To open:** press the marking on cover ①.
- ⓘ You can remove the non-slip mat and the insert for cleaning. When removing the insert you will have to overcome some slight resistance.

Stowage compartment under the armrest



► **To open:** on vehicles with movable armrests, make sure that the armrest is in the rearmost position.

► Press button ① and fold the armrest up.

Depending on the vehicle equipment, the armrest can be moved backwards or forwards in a longitudinal direction.

Depending on the vehicle's equipment, the following may be in the stowage compartment: a multimedia connector unit with an SD card slot and 2 USB ports, e.g. for use with an iPod®, iPhone® or MP3 player; see the separate operating instructions.

Stowage compartment under the driver's seat and front-passenger seat

WARNING

If you exceed the maximum load for the stowage compartment, the cover may not be able to restrain the items. Items may be thrown out of the stowage compartment and hit vehicle occupants. There is a risk of injury, particularly in the event of sudden braking or a sudden change in direction.

Never exceed the maximum permissible load for the stowage compartment. Stow and secure heavy objects in the trunk.

The maximum permissible load of the stowage compartment is 2.6 lbs (1.2 kg).

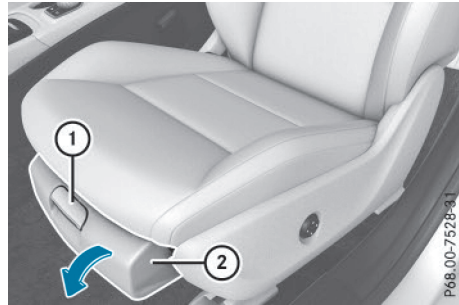

► **To open:** pull handle ① up and fold cover ② forwards.

Stowage space in the rear

Stowage compartment in the rear center console

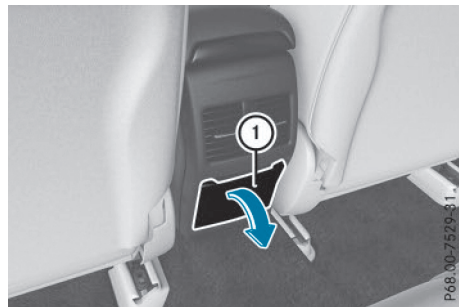

► **To open:** pull down the top of stowage compartment ① by the edge of the handle.

i Depending on the vehicle's equipment, there may be an open stowage space above the stowage compartment.

Parcel nets

Stowage nets are located:

- in the front-passenger footwell
- on the back of the driver's and the front-passenger seat
- on the left and right-hand side in the trunk

Observe the loading guidelines (► page 233) and the safety notes regarding stowage spaces (► page 233).

Through-loading facility in the rear

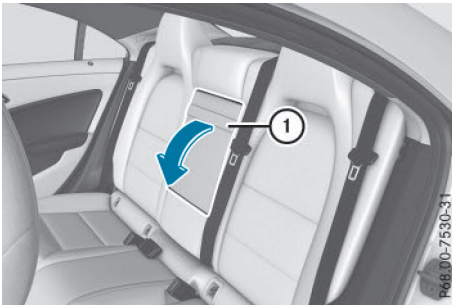

- ▶ **To open:** fold down seat armrest ①.
- ▶ Pull the center head restraint on the rear bench seat into the uppermost position (▷ page 91).

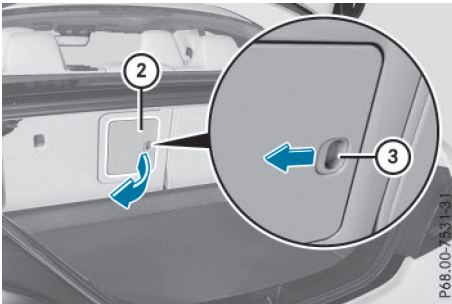

- ▶ Slide locking mechanism ③ in the direction of the arrow.
 - ▶ Swing flap ② fully to the side. Flap ② is held open by a magnet.
 - ▶ **To close:** swing flap ② in the trunk back until it engages.
 - ▶ Fold armrest ① up fully if necessary.
- Observe the loading guidelines (▷ page 233).

Cargo compartment enlargement

Important safety notes

WARNING

If the rear bench seat/rear seat and seat backrest are not engaged they could fold forwards, e.g. when braking suddenly or in the event of an accident.

- The vehicle occupant would thereby be pushed into the seat belt by the rear bench seat/rear seat or by the seat backrest. The seat belt can no longer offer the intended level of protection and could even cause injuries.
 - Objects or loads in the trunk cannot be restrained by the seat backrest.
- There is an increased risk of injury.

Before every trip, make sure that the seat backrests and the rear bench seat/rear seat are engaged.

- ❗ Before folding the backrest in the rear compartment forwards, make sure that the rear compartment armrest and the cupholder are folded in. They may otherwise be damaged.

Observe the loading guidelines (▷ page 233).

The left-hand and right-hand rear seat backrests can be folded forwards separately to increase the trunk capacity.

Folding the rear seat backrest forwards and back

Folding the rear seat backrests forward

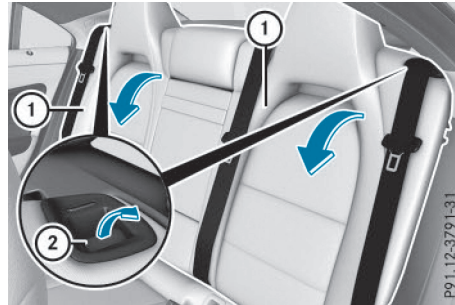

- ▶ Fully insert the backrest head restraints if necessary (▷ page 92).
- ▶ Move the driver's or front-passenger seat forward if necessary.
- ▶ Pull left-hand or right-hand release handle ② of the seat backrest forwards. Corresponding seat backrest ① is released.
- ▶ Fold backrest ① forwards.
- ▶ Move the driver's or front-passenger seat back if necessary.

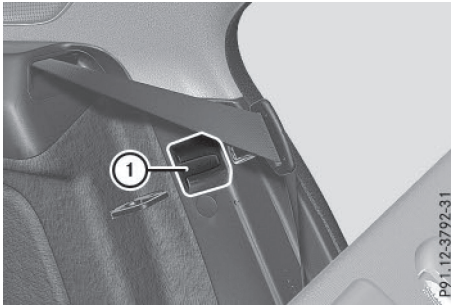

▶ Insert the seat belt into seat-belt holder ①.

Folding the rear seat backrest back

! Make sure that the seat belt does not become trapped when folding the rear seat backrest back. Otherwise, it could be damaged.

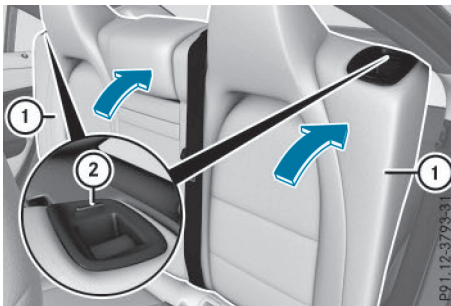

- ▶ Move the driver's or front-passenger seat forward if necessary.
- ▶ Fold seat backrest ① back until it engages. Red lock status indicator ② is no longer visible.
- ▶ Adjust the head restraints if necessary (▷ page 92).
- ▶ Move the driver's or front-passenger seat back if necessary.

Securing loads

Observe the following notes on securing loads:

- Observe the loading guidelines (▷ page 233).
- Secure the load using the cargo tie-down rings.
- Distribute the load on the cargo tie-down rings evenly.

- Do not use elastic straps or nets to secure a load, as these are only intended as an anti-slip protection for light loads.
- Do not route tie-downs across sharp edges or corners.
- Pad sharp edges for protection.

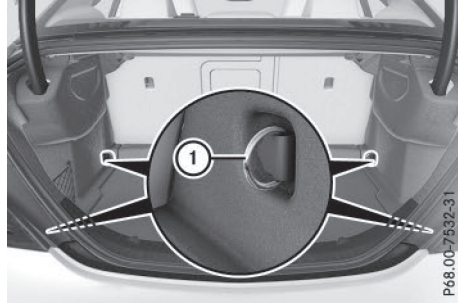

① Cargo tie-down rings

Stowage well under the trunk floor

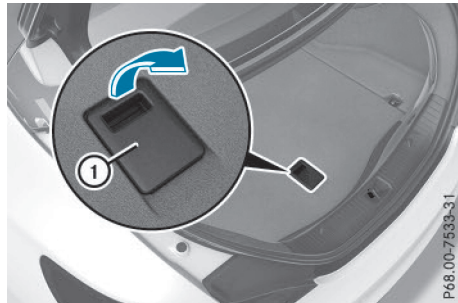

Under the trunk floor you can find a bracket for TIREFIT and the vehicle tool kit, etc.

▶ **To open:** pull handle ① up.

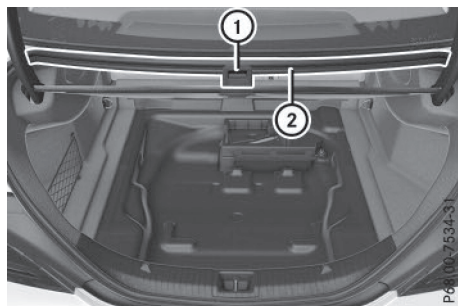

▶ Hook handle ① into rain trough ②.

To enlarge the trunk you can remove the trunk floor.

- ▶ **To remove:** lift the trunk floor almost to rain trough ② and pull it out.

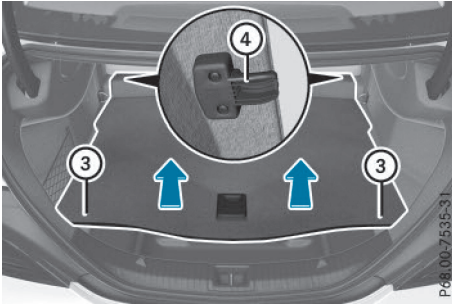

- ▶ **To insert:** place the trunk floor at the bottom in the center.
- ▶ Hold sides of trunk floor ③ and press in the direction of the arrow until it engages in hooks ④.

Roof carrier

Important safety notes

WARNING

When you load the roof, the center of gravity of the vehicle rises and the driving characteristics change. If you exceed the maximum roof load, the driving characteristics, as well as steering and braking, will be greatly impaired. There is a risk of an accident.

Never exceed the maximum roof load and adjust your driving style.

- ❗ Mercedes-Benz recommends that you only use roof carriers that have been tested and approved for Mercedes-Benz vehicles. This helps to prevent damage to the vehicle.

Position the load on the roof rack in such a way that the vehicle will not sustain damage even when it is in motion.

Depending on the vehicle equipment, ensure that when the roof carrier is installed you can:

- open the panorama roof with power tilt/sliding panel fully
- open the trunk lid fully

You will find information on the maximum roof load in the "Technical data" section (> page 314).

An incorrectly secured roof carrier or roof load may become detached from the vehicle. You must therefore ensure that you observe the roof carrier manufacturer's installation instructions.

Attaching the roof carrier

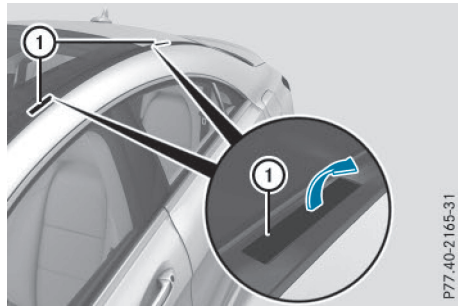

- ▶ Open and fold the covers ① upwards carefully in the direction of the arrow.
- ▶ Only secure the roof carrier to the anchorage points under covers ①.
- ▶ Observe the manufacturer's installation instructions.

Features

Cup holder

Important safety notes

WARNING

The cup holder cannot hold a container secure whilst traveling. If you use a cup holder whilst traveling, the container may be flung around and liquid may be spilled. The vehicle occupants may come into contact with the liquid and if it is hot, they may be scalded. You may be distracted from the traffic conditions and you could lose control of the vehicle. There is a risk of an accident and injury.

Only use the cup holder when the vehicle is stationary. Only use the cup holder for containers of the right size. Always close the container, particularly if the liquid is hot.

WARNING

If objects in the passenger compartment are stowed incorrectly, they can slide or be thrown around and hit vehicle occupants. In addition, cupholders, open stowage spaces and mobile phone brackets cannot always retain all objects they contain. There is a risk of injury, particularly in the event of sudden braking or a sudden change in direction.

- Always stow objects so that they cannot be thrown around in such situations.
- Always make sure that objects do not protrude from stowage spaces, parcel nets or stowage nets.
- Close the lockable stowage spaces before starting a journey.
- Always stow and secure heavy, hard, pointed, sharp-edged, fragile or bulky objects in the trunk.

! Only use the cup holders for containers of the right size and which have lids. The drinks could otherwise spill.

Observe the loading guidelines (▷ page 233). The stowage compartments in the doors provide space for bottles:

- front: capacity up to 34 fl. oz. (1.0 l)
- rear: capacity up to 17 fl. oz. (0.5 l)

Cup holder in the front center console



① Cup holder

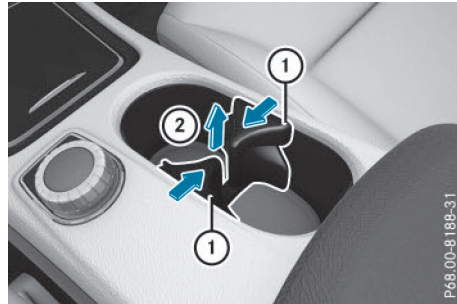

The cup holder and the rubber mat underneath can be removed for cleaning. Clean them with clean, lukewarm water only.

- ▶ **To remove:** carefully pull in upper sections of cup holder ① on the driver's and front-passenger sides until they release.
- ▶ Lift the cup holder upwards ② until it can be removed.

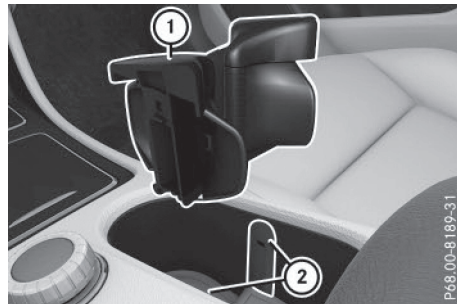

- ▶ **To install:** insert cup holder into lateral curved sections ② in the stowage compartment. Insert the cup holder so that the wedge of the upper section of cup holder ① faces forwards.
- ▶ Press the cup holder downwards until it engages on the right and left-hand sides.

Cup holder in the rear seat armrest

! Do not sit on or support your body weight on the rear seat armrest when it is folded down, as you could otherwise damage it.

! Close the cup holder before folding the rear seat armrest up. Otherwise, the cup holder could be damaged.



- ▶ Fold down the rear seat armrest.
- ▶ **To open:** press the front of cup holder ① or ②. Cup holder ① or ② extends automatically.
- ▶ **To close:** slide cup holder ① or ② back until it engages.

Sun visors

Overview

WARNING

If the mirror cover of the vanity mirror is folded up when the vehicle is in motion, you could be blinded by incident light. There is a risk of an accident.

Always keep the mirror cover folded down while driving.

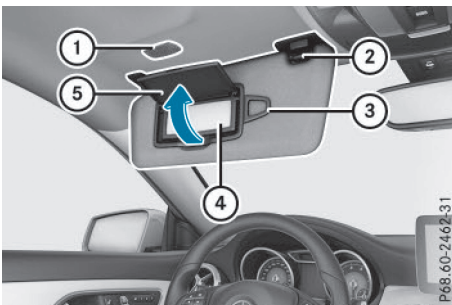

- ① Mirror light
- ② Bracket
- ③ Retaining clip, e.g. for a car park ticket
- ④ Vanity mirror
- ⑤ Mirror cover

Vanity mirror in the sun visor

Mirror light ① only functions if the sun visor is clipped into bracket ② and mirror cover ⑤ has been folded up.

Glare from the side

- ▶ Fold down the sun visor.
- ▶ Pull the sun visor out of retainer ②.
- ▶ Swing the sun visor to the side.

Ashtray

Front ashtray

 The stowage space under the ashtray is not heat resistant. Before placing lit cigarettes in the ashtray, make sure that the ashtray is properly engaged. Otherwise, the stowage space could be damaged.

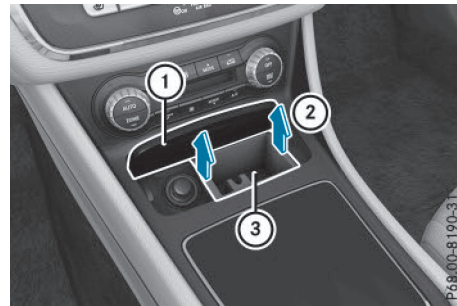

- ▶ **Vehicles with a stowage compartment cover:** press the lower section of cover ①. The stowage compartment opens.
 - ▶ **To remove the insert:** lift insert ③ up ② and out.
 - ▶ **To re-install the insert:** press insert ③ into the holder until it engages.
-  If you remove the ashtray insert, you can use the resulting compartment for stowage.

Rear compartment ashtray

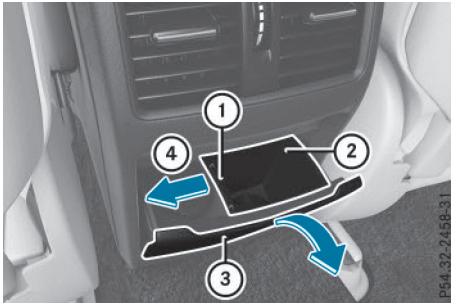

- ▶ **To open:** pull cover (3) out by its top edge.
- ▶ **To remove:** pull insert (2) by recess (1) in the direction of arrow (4) until it audibly releases.
- ▶ Lift insert (2) up and out.
- ▶ **To install the insert:** install insert (2) from above into the holder and press down until it engages.

Cigarette lighter

WARNING

You can burn yourself if you touch the hot heating element or the socket of the cigarette lighter.

In addition, flammable materials can ignite if:

- the hot cigarette lighter falls
- a child holds the hot cigarette lighter to objects, for example

There is a risk of fire and injury.

Always hold the cigarette lighter by the knob. Always make sure that the cigarette lighter is out of reach of children. Never leave children unsupervised in the vehicle.

Your attention must always be focused on the traffic conditions. Only use the cigarette lighter when road and traffic conditions permit.

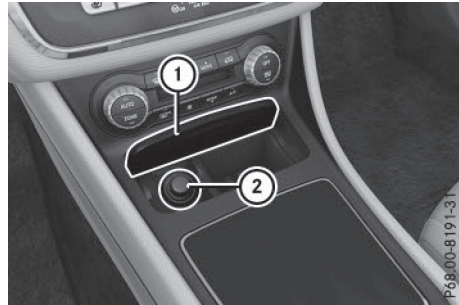

- ▶ Turn the SmartKey to position **2** in the ignition lock (▷ page 121).
- ▶ **Vehicles with a stowage compartment cover:** press the lower section of cover (1). The stowage compartment opens.
- ▶ Press in cigarette lighter (2). Cigarette lighter (2) will pop out automatically when the heating element is red-hot.

12 V sockets

General notes

- ▶ Turn the SmartKey to position **1** in the ignition lock (▷ page 121).

The sockets can be used for accessories with a maximum draw of 180 W (15 A). Accessories include such items as chargers for mobile phones.

If you use the sockets for long periods when the engine is switched off, the battery may discharge.

An emergency cut-out ensures that the on-board voltage does not drop too low. If the on-board voltage is too low, the power to the sockets is automatically cut. This ensures that there is sufficient power to start the engine.

Socket in the front center console

- ▶ **Vehicles with a stowage compartment cover:** press the lower section of the cover. The stowage compartment opens.
- ▶ Lift up the cover of the socket.

Socket in the rear compartment center console

- ▶ Pull the cover out by the top of the handle edge.
- ▶ Lift up the cover of the socket.

Socket in the trunk

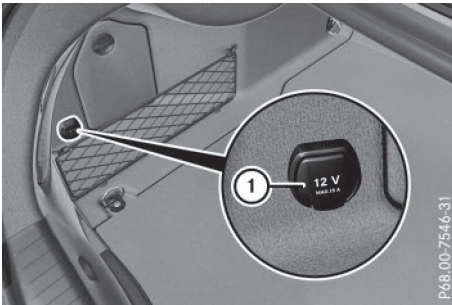

- ▶ Lift up the cover of socket ①.

mbrace

General notes

The mbrace system is only available in the USA. You must have a license agreement to activate the mbrace service. Make sure that your system is activated and operational. To log in, press the  MB Info call button. If any of the steps mentioned are not carried out, the system may not be activated.

If you have questions about the activation, contact one of the following telephone hotlines: Mercedes-Benz Customer Assistance Center at 1-800-FOR-MERCEDES (1-800-367-6372) or 1-866-990-9007

Shortly after successfully registering with the mbrace service, a user ID and password will be sent to you by mail. You can use this password to log onto the mbrace area under "Owners Online" at <http://www.mbusa.com>.

The system is available if:

- it has been activated and is operational
- the corresponding mobile phone network is available for transmitting data to the Customer Center
- a service subscription is available

Determining the location of the vehicle on a map is only possible if:

- GPS reception is available.
- the vehicle position can be forwarded to the Customer Assistance Center

The mbrace system

To adjust the volume during a call, proceed as follows:

- ▶ Press the  or  button on the multi-function steering wheel.

or

- ▶ Use the multimedia system's volume control.

The system offers various services, e.g.:





- Automatic and manual emergency call
- Roadside Assistance call
- MB Info call

You can find information and a description of all available features under "Owners Online" at <http://www.mbusa.com>.

System self-test

After you have switched on the ignition, the system carries out a self-diagnosis.

A malfunction in the system has been detected if one of the following occurs:

- The indicator lamp in the SOS button does not come on during the system self-test.
- The indicator lamp in the  Roadside Assistance button does not light up during self-diagnosis of the system.
- The indicator lamp in the  MB Info call button does not light up during self-diagnosis of the system.
- The indicator lamp in one or more of the following buttons continues to light up red after the system self-diagnosis:
 - SOS button
 -  Roadside Assistance call button
 -  MB Info call button
- The **Inoperative** or the **Service Not Activated** message appears in the multi-function display after the system self-diagnosis.

If a malfunction is indicated as outlined above, the system may not operate as expected. In the event of an emergency, help will have to be summoned by other means.

Have the system checked at the nearest Mercedes-Benz Service Center or contact the following service hotlines:

Mercedes-Benz Customer Assistance Center at 1-800-FOR-MERCEdes (1-800-367-6372) or 1-866-990-9007

Emergency call

Important safety notes

WARNING

It can be dangerous to remain in the vehicle, even if you have pressed the SOS button in an emergency if:

- you see smoke inside or outside of the vehicle, e.g. if there is a fire after an accident
- the vehicle is on a dangerous section of road
- the vehicle is not visible or cannot easily be seen by other road users, particularly when dark or in poor visibility conditions

There is a risk of an accident and injury.

Leave the vehicle immediately in this or similar situations as soon as it is safe to do so.

Move to a safe location along with other vehicle occupants. In such situations, secure the vehicle in accordance with national regulations, e.g. with a warning triangle.

General notes

Observe the notes on system activation (► page 242).

An emergency call is dialed automatically if an air bag or Emergency Tensioning Device is triggered. You cannot end an automatically triggered emergency call yourself.

An emergency call can also be initiated manually.

As soon as the emergency call has been initiated, the indicator lamp in the SOS button flashes. The **Connecting Call** message appears in the multifunction display.

The audio output is muted.

Once the connection has been made, the **Call Connected** message appears in the multifunction display.

All important information on the emergency is transmitted, for example:

- current location of the vehicle (as determined by the GPS system)
- vehicle identification number
- information on the severity of the accident

Shortly after the emergency call has been initiated, a voice connection is automatically established between the Customer Assistance Center and the vehicle occupants.

- If the vehicle occupants respond, the Mercedes-Benz Customer Assistance Center attempts to get more information on the emergency.
- If there is no response from the vehicle occupants, an ambulance is immediately sent to the vehicle.

If no voice connection can be established to the Mercedes-Benz Customer Assistance Center, the system has been unable to initiate an emergency call.

This can occur, for example, if the relevant mobile phone network is not available. The indicator lamp in the SOS button flashes continuously.

The **Call Failed** message appears in the multifunction display and must be confirmed.

In this case, summon assistance by other means.

Making an emergency call

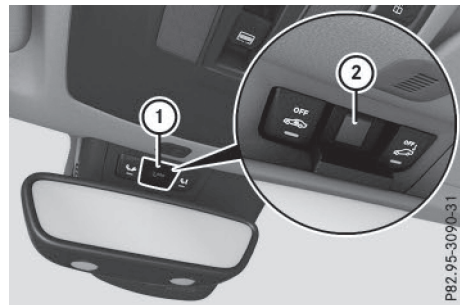

- **To initiate an emergency call manually:** press cover ① briefly to open.
- Press and hold the SOS button for at least one second ②. The indicator lamp in SOS button ② flashes until the emergency call is concluded.
- Wait for a voice connection to the Mercedes-Benz Customer Assistance Center.

► **To end a call:** press the  button on the multifunction steering wheel.

- or
- Press the corresponding multimedia system button for ending a phone call.
 - After the emergency call, close cover ①.

If the mobile phone network is unavailable, mbrace will not be able to make the emergency call. If you leave the vehicle immediately after pressing SOS button ②, you do not know if mbrace has successfully made the emergency call. In this case, always summon assistance by other means.

Breakdown assistance button



- **To make a call:** press Roadside assistance call button ①. This initiates a call to the Mercedes-Benz Customer Assistance Center. The indicator lamp in Roadside assistance button ① flashes while the call is active. The **Connecting Call** message appears on the multifunction display. The audio output is muted.

If a connection can be established, the **Call Connected** message appears in the multifunction display.

If a mobile phone network and GPS reception are available, the system transfers data to the Mercedes-Benz Customer Assistance Center, for example:

- current location of the vehicle
- vehicle identification number

The display of the multimedia system indicates that a call is active. During the call, you can change to the navigation menu by pressing the NAVI button on the multimedia system, for example.

Voice output is not available in this case.

A voice connection is established between the Mercedes-Benz Customer Assistance Center and the vehicle occupants.

From the remote malfunction diagnosis, the Mercedes-Benz Customer Assistance Center can ascertain the nature of the problem (▷ page 247).

The Mercedes-Benz Customer Assistance Center either sends a qualified Mercedes-Benz technician or makes arrangements for your vehicle to be transported to the nearest Mercedes-Benz Service Center.

You may be charged for services such as repair work and/or towing.

You can find more information in the separate mbrace manual.

The system has not been able to initiate a Roadside assistance call, if:

- the  indicator lamp for the Roadside assistance call button is flashing continuously.
- no voice connection to the Mercedes-Benz Customer Assistance Center was established.

This can occur if the relevant mobile phone network is not available, for example.

The **Call Failed** message appears on the multifunction display.

- **To end a call:** press the  button on the multifunction steering wheel.

or

- Press the corresponding multimedia system button for ending a phone call.

MB Info call button



- **To make a call:** press MB Info call button ①. This initiates a call to the Mercedes-Benz Customer Assistance Center.

The indicator lamp in MB Info call button ① flashes while the connection is being made. The **Connecting Call** message appears on the multifunction display. The audio output is muted.

If a connection can be established, the **Call Connected** message appears in the multifunction display.

If a mobile phone network and GPS reception are available, the system transfers data to the Mercedes-Benz Customer Assistance Center, for example:

- current location of the vehicle
- vehicle identification number

The display of the multimedia system indicates that a call is active. During the call, you can change to the navigation menu by pressing the NAVI button on the multimedia system, for example.

Voice output is not available in this case.

A voice connection is established between the Mercedes-Benz Customer Assistance Center and the vehicle occupants.

You receive information about operating your vehicle, about the nearest Mercedes-Benz Service Center and about other products and services from Mercedes-Benz.

You can find further information on the mbrace system under "Owners Online" at <http://www.mbusa.com>.

The system has not been able to initiate an MB Info call, if:

- the indicator lamp in MB Info call button  is flashing continuously.
- no voice connection to the Mercedes-Benz Customer Assistance Center was established.

This can occur if the relevant mobile phone network is not available, for example.

The **Call Failed** message appears on the multifunction display.

► **To end a call:** press the  button on the multifunction steering wheel.

or

► Press the corresponding multimedia system button for ending a phone call.

Call priority

When service calls are active, e.g. Roadside Assistance or MB Info calls, an emergency call can still be initiated. In this case, an emergency call will take priority and override all other active calls.

The indicator lamp of the respective button flashes until the call is ended.

An emergency call can only be terminated by the Mercedes-Benz Customer Assistance Center.

All other calls can be ended by pressing:

- the  button on the multifunction steering wheel
- the corresponding button in the multimedia system to end the voice call

When a call is initiated, the audio system is muted.

The mobile phone is no longer connected to the multimedia system.

However, if you want to use your mobile phone, do so only when the vehicle is stationary and in a safe location.



Downloading destinations

Downloading destinations

Downloading destinations gives you access to a database with over 15 million points of interest (POIs). These can be downloaded on the navigation system in your vehicle. If you know the destination, the address can be downloaded. Alternatively, you can obtain the location of Points of Interest (POIs)/important destinations in the vicinity.

Furthermore, you can download routes with up to four way points.

You are prompted to confirm route guidance to the address entered.

► Select **Yes** by turning  or sliding  the controller and confirm with .

The system calculates the route and subsequently starts the route guidance with the address entered.

If you select **No** the address can be stored in the address book.

The destination download function is available if:

- the vehicle is equipped with a navigation system.
- the relevant mobile phone network is available and data transfer is possible.

Route Assistance

This service is part of the mbrace PLUS Package and cannot be purchased separately.

You can use the Route Assistance function even if the vehicle is not equipped with a navigation system.

Within the framework of this service, you receive a professional and reliable form of navigation support without having to leave your vehicle.

The customer service representative finds a suitable route depending on your vehicle's current position and the desired destination. You will then be guided live through the current route section.

Search & Send

General notes

To use "Search & Send", your vehicle must be equipped with mbrace and a navigation system. Additionally, an mbrace service subscription must be completed.

"Search & Send" is a destination entry service. A destination address found on Google Maps™ can be transferred via mbrace directly to your vehicle's navigation system.

Specifying and sending the destination address

- ▶ Go to the website <http://maps.google.com> and enter a destination address into the entry field.
- ▶ **To send the destination address to the e-mail address of your mbrace account:** click on the corresponding button on the website.
Example:
If you select 'Send to vehicle' and then 'Mercedes-Benz', the destination address will be sent to your vehicle.
- ▶ When the "Send" dialog window appears:

Enter the e-mail address you specified when setting up your mbrace account into the corresponding field.

- ▶ Click "Send".

Information on specific commands such as "Address entry" or "Send" can be found on the website.

Calling up a transmitted destination address

- ▶ Turn the SmartKey to position **2** in the ignition lock (▷ page 121).

The transmitted destination address is loaded into the vehicle's navigation system.

A display message appears, asking whether navigation should be started.

- ▶ Select **Yes** by turning  or sliding  the controller and confirm with .

The system calculates the route and subsequently starts the route guidance with the address entered.

If you select **No** the address can be stored in the address book.

If you have sent more than one destination address, each individual destination must be confirmed separately.

Destination addresses are loaded in the same order as the order in which they were sent.

If you own multiple Mercedes-Benz vehicles with mbrace and activated mbrace accounts:

If multiple vehicles are registered under the same e-mail address, the destination will be sent to all the vehicles.

Vehicle remote opening

You can use the vehicle remote opening if you have unintentionally locked your vehicle and a replacement SmartKey is not available.

The vehicle can be opened by the Mercedes-Benz Customer Assistance Center.

The vehicle can be immediately opened remotely within four days of the ignition being turned off. After this time, the remote unlocking may be delayed by 15 to 60 minutes. After 30 days, the vehicle can no longer be opened remotely.

The vehicle remote unlocking feature is available if the relevant mobile phone network is available and a data connection is possible.

- ▶ Contact the following service hotlines:

Mercedes-Benz Customer Assistance Center at 1-800-FOR-MERCEdes (1-800-367-6372) or 1-866-990-9007

You will be asked for your password.

- ▶ Return to your vehicle at the time agreed upon with the Mercedes-Benz Customer Assistance Center.

Alternatively, the vehicle can be opened via:

- the Internet, under the "Owners Online" section
- telephone applications (e.g. for iPhone®, Android™)

To do this, you will need your identification number and password.

Vehicle remote closing

The vehicle remote-closing feature can be used when you have forgotten to lock the vehicle and you are no longer nearby.

The vehicle can then be locked by the Mercedes-Benz Customer Assistance Center.

The vehicle can be immediately remotely locked within four days of the ignition being turned off. After this time, remote closing may be delayed by 15 to 60 minutes. After 30 days the vehicle can no longer be valet locked remotely.

The vehicle remote closing feature is available if the relevant mobile phone network is available and a data connection is possible.

- ▶ Contact the following service hotlines:
Mercedes-Benz Customer Assistance Center at 1-800-FOR-MERCEdes (1-800-367-6372) or 1-866-990-9007
You will be asked for your password.

The next time you are inside the vehicle and you switch on the ignition, the **Doors Locked Remotely** message appears in the multifunction display.

Alternatively, the vehicle can be locked via:

- the Internet, under the "Owners Online" section
- telephone applications (e.g. for iPhone®, Android™)

To do this, you will need your identification number and password.

Stolen vehicle recovery service

If your vehicle has been stolen:

- ▶ Notify the police.
The police will issue a numbered incident report.
- ▶ This number will be forwarded to the Mercedes-Benz Customer Assistance Center together with your PIN.
The Mercedes-Benz Customer Assistance Center then tries to locate the system. The Mercedes-Benz Customer Assistance Center contacts you and the local law enforcement agency if the vehicle is located.
However, only the law enforcement agency is informed of the location of the vehicle.

If the anti-theft alarm system is activated for longer than 30 seconds, the Mercedes-Benz Customer Assistance Center is automatically notified.

Vehicle Health Check

With the Vehicle Health Check, the Customer Assistance Center can provide improved support for problems with your vehicle. During an existing call, vehicle data is transferred to the Customer Assistance Center.

The customer service representative can use the received data to decide what kind of assistance is required. You are then, for example, guided to the nearest Mercedes-Benz Service Center or a recovery vehicle is called.

If vehicle data needs to be transferred during an MB Info call or a Roadside Assistance call, this is initiated by the Customer Assistance Center.

The **Roadside Assistance Connected** message appears in the display. If the Vehicle Health Check can be started, the **Request for Vehicle Diagnostics Received Start vehicle diagnostics?** message appears in the display.

- ▶ Press the **Yes** button to confirm the message.
- ▶ When the **Vehicle Diagnostics Please Start Ignition** message appears: turn the SmartKey to position **2** in the ignition lock (▷ page 121).
- ▶ If the **Please follow the instructions received by phone and move your vehicle to a safe position.** message appears: please follow the instructions

received by phone and move your vehicle to a safe position.

The message in the display disappears.

The vehicle operating state check begins.

During this procedure, you will see the **Vehicle Diagnostics Active** message.

If you select **Cancel**, the Vehicle Health Check is canceled completely.

When the check is complete, the **Sending vehicle diagnostics data. (Voice connection may be interrupted during data transfer)** message appears. The vehicle data can now be sent.

► Press the **OK** button to confirm the message.

The voice connection with the Customer Assistance Center is terminated.

The **Vehicle Diagnostics: Transferring Data...** message appears.

The vehicle data is sent to the Customer Assistance Center.

Depending on what the customer service representative agreed with you, the voice connection is re-established after the transfer is complete. If necessary, you will be contacted at a later time by another means, e.g. by e-mail or phone.

Another function of the Vehicle Health Check is the transfer of service data to the Customer Assistance Center. If a service is due, the display shows a message to this effect together with information about any special offers at your workshop.

This information can also be called up under "Owners Online" at <http://www.mbusa.com>.

Information on the data stored in the vehicle (▷ page 28).

Information on Roadside Assistance

(▷ page 25).

Downloading routes

Downloading routes allows you to transfer and save predefined routes in the navigation system.

A route can be prepared and sent by either a customer service representative or under "Owners Online" at <http://www.mbusa.com>.

Each route can include up to four way points.

Once a route has been received by the navigation system, you will see the **Do you want to start route guidance? Destination Received destination has been saved**

in "Previous destinations" message on the multimedia system display.

The route is saved.

► **To start route guidance:** select **Yes**.

An overview of the route is shown in the display.

If you select **No**, the saved route can be called up later in the navigation menu.

► Select **Start**.

Route guidance starts.

Downloaded and saved routes can be called up again.

Speed alert

You can define the upper speed limit, which must not be exceeded by the vehicle.

If this selected speed is exceeded by the vehicle, a message will be sent to the Customer Assistance Center. The Customer Assistance Center then forwards this information to you.

You can select the way in which you receive this information beforehand. Possible options include text message, e-mail or an automated call.

The data you receive contains the following information:

- the location where the speed limit was exceeded
- the time at which the speed limit was exceeded
- the selected speed limit which was exceeded

Geo fencing

Geo fencing allows you to select areas which the vehicle should not enter or leave. You will be informed if the vehicle crosses the boundaries of the selected areas. You can select the way in which you receive this information beforehand. Possible options include text message, e-mail or an automated call.

The area can be determined as either a circle or a polygon with a maximum of ten corners. You can specify up to ten areas simultaneously. Different settings are possible for each area.

These settings can be called up under "Owners Online" at <http://www.mbusa.com>.

Alternatively, you can trigger an MB Info call and inform the customer service representative that you wish to activate geo fencing.

Currently inactive areas can be activated by text message.

Triggering the vehicle alarm

With this function, you can trigger the vehicle's panic alarm via text message. An alarm sounds and the exterior lighting flashes. Depending on the setting, the panic alarm lasts five or ten seconds. Afterwards, the alarm switches off.

Garage door opener

General notes

The HomeLink® garage door opener integrated in the rear-view mirror allows you to operate up to three different door and gate systems.

Use the integrated garage door opener only on garage doors that:

- have safety stop and reverse features and
- meet current U.S. federal safety standards

Once programmed, the integrated garage door opener in the rear-view mirror will assume the function of the garage door system's remote control. Please also read the operating instructions for the garage door system.

When programming a garage door opener, park the vehicle outside the garage. Do not leave the engine running while programming.

Certain garage door drives are incompatible with the integrated garage door opener. If you have difficulty programming the integrated garage door opener, contact a Mercedes-Benz Service Center.

Alternatively, you can call the following telephone assistance services:

- **USA:** Mercedes-Benz Customer Assistance Center at 1-800-FOR-MERCEdes
- **Canada:** Customer Service at 1-800-387-0100
- HomeLink® hotline 1-800-355-3515 (free of charge)

More information on HomeLink® and/or compatible products is also available online at <http://www.homelink.com>.

Notes on the declaration of conformity (▷ page 26).

USA: FCC ID: CB2HMIHL4

Canada: IC: 279B-HMIHL4

Important safety notes

⚠ WARNING

When you operate or program the garage door with the integrated garage door opener, persons in the range of movement of the garage door can become trapped or struck by the garage door. There is a risk of injury.

When using the integrated garage door opener, always make sure that nobody is within the range of movement of the garage door.

⚠ WARNING

Combustion engines emit poisonous exhaust gases such as carbon monoxide. Inhaling these exhaust gases leads to poisoning. There is a risk of fatal injury. Therefore never leave the engine running in enclosed spaces without sufficient ventilation.

Programming

Programming the buttons

Pay attention to the "Important safety notes" (▷ page 249).

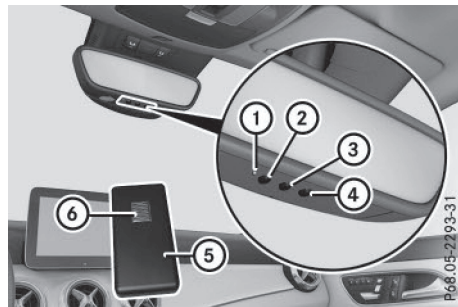

Garage door remote control ⑤ is not included with the integrated garage door opener.

- ▶ Turn the SmartKey to position ② in the ignition lock (▷ page 121).
- ▶ Select one of buttons ② to ④ to control the garage door drive.

- ▶ **To start program mode:** press and hold one of buttons ② to ④ on the integrated garage door opener.

The garage door opener is now in program mode. After a short time, indicator lamp ① lights up yellow.

Indicator lamp ① lights up yellow as soon as button ②, ③ or ④ is stored for the first time. If the selected button has already been programmed, indicator lamp ① will only light up yellow after ten seconds have elapsed.

- ▶ Release button ②, ③ or ④. Indicator lamp ① flashes yellow.
 - ▶ **To program the remote control:** point garage door remote control ⑤ towards buttons ② to ④ on the rear-view mirror at a distance of 2 to 8 in (5 to 20 cm).
 - ▶ Press and hold button ⑥ on remote control ⑤ until indicator lamp ① lights up green. When indicator lamp ① lights up green: programming is finished.
- When indicator lamp ① flashes green: programming was successful. The next step is to synchronize the rolling code (▷ page 250).

- ▶ Release button ⑥ on remote control ⑤ for the garage door drive system. If indicator lamp ① lights up red: repeat the programming procedure for the corresponding button on the rear-view mirror. When doing so, vary the distance between remote control ⑤ and the rear-view mirror.

The required distance between remote control ⑤ and the integrated garage door opener depends on the garage door drive system. Several attempts might be necessary. You should test every position for at least 25 seconds before trying another position.

Synchronizing the rolling code

Pay attention to the "Important safety notes" (▷ page 249).

If the garage door system uses a rolling code, you will also have to synchronize the garage door system with the integrated garage door opener in the rear-view mirror. To do this you will need to use the programming button on the door drive control panel. The programming button may be located in different places depending on the manufacturer. It is usually located on the door drive unit on the garage ceiling.

Familiarize yourself with the garage door drive operating instructions, e.g. under "Program-

ming additional remote controls", before carrying out the following steps.

Your vehicle must be within reach of the garage door or gate opener drive. Make sure that neither your vehicle nor any persons/objects are present within the sweep of the door or gate.

- ▶ Turn the SmartKey to position **2** in the ignition lock (▷ page 121).
- ▶ Get out of the vehicle.
- ▶ Press the programming button on the door drive unit. Usually, you now have 30 seconds to initiate the next step.
- ▶ Get into the vehicle.
- ▶ Press previously programmed button ②, ③ or ④ on the integrated garage door opener repeatedly and in quick succession until the door closes. The rolling code synchronization is then complete.

Notes on programming the remote control

Canadian radio frequency laws require a "break" (or interruption) of the transmission signals after broadcasting for a few seconds. Therefore, these signals may not last long enough for the integrated garage door opener. The signal is not detected during programming. Comparable with Canadian law, some U.S. garage door openers also feature a "break".

Proceed as follows:

- if you live in Canada
 - if you have difficulties programming the garage door opener (regardless of where you live) as you follow the programming steps.
- ▶ Press and hold one of buttons ② to ④ on the integrated garage door opener. After a short time, indicator lamp ① lights up yellow.
 - ▶ Release the button. Indicator lamp ① flashes yellow.
 - ▶ Press button ④ of garage door remote control ⑤ for two seconds, then release it for two seconds.
 - ▶ Press button ⑥ again for two seconds.
 - ▶ Repeat this sequence on button ⑥ of remote control ⑤ until indicator lamp ① lights up green. When indicator lamp ① lights up green: programming is finished.

When indicator lamp ① flashes green: programming was successful. The next step is to synchronize the rolling code.

- ▶ Release button ⑥ of remote control ⑤ of the garage door drive.

If indicator lamp ① lights up red: repeat the programming process for the corresponding button on the rear-view mirror. When doing so, vary the distance between remote control ⑤ and the rear-view mirror.

The required distance between remote control ⑤ and the integrated garage door opener depends on the garage door drive system. Several attempts might be necessary. You should test every position for at least 25 seconds before trying another position.

Problems when programming

If you are experiencing problems programming the integrated garage door opener on the rear-view mirror, take note of the following instructions:

- Check the transmitter frequency used by garage door drive remote control ⑤ and whether it is supported. The transmitter frequency can usually be found on the back of remote control ⑤ for the garage door drive. The integrated garage door opener is compatible with devices that have units which operate in the frequency range of 280 to 433 MHz.
- Replace the batteries in garage door remote control ⑤. This increases the likelihood that garage door remote control ⑤ will transmit a strong and precise signal to the integrated garage door opener.
- When programming, hold remote control ⑤ at varying distances and angles from buttons ② to ④ which you are programming. Try various angles at a distance between 2 and 8 inches (5 to 20 cm) or at the same angle but at varying distances.
- If another remote control ⑤ is available for the same garage door drive, repeat the same programming steps with this remote control ⑤. Before performing these steps, make sure that new batteries have been installed in garage door drive remote control ⑤.
- Note that some remote controls only transmit for a limited amount of time (the indicator lamp on the remote control goes out). Press

button ⑥ on remote control ⑤ again before transmission ends.

- Align the antenna cable of the garage door opener unit. This can improve signal reception/transmission.

Opening/closing the garage door

After it has been programmed, the integrated garage door opener performs the function of the garage door system remote control. Please also read the operating instructions for the garage door system.

- ▶ Turn the SmartKey to position **2** in the ignition lock (▷ page 121).
- ▶ Press button ②, ③ or ④ which you have programmed to operate the garage door. Garage door system with a fixed code: indicator lamp ① lights up green. Garage door system with a rolling code: indicator lamp ① flashes green.

The transmitter will transmit a signal as long as the button is pressed. The transmission is halted after a maximum of ten seconds and indicator lamp ① lights up yellow.

- ▶ Press button ②, ③ or ④ again if necessary.

Clearing the memory

Make sure that you clear the memory of the integrated garage door opener before selling the vehicle.

- ▶ Turn the SmartKey to position **2** in the ignition lock (▷ page 121).
- ▶ Press and hold buttons ② and ④. The indicator lamp initially lights up yellow and then green.
- ▶ Release buttons ② and ④. The memory of the integrated garage door opener in the rear-view mirror is cleared.

Compass

Calling up the compass

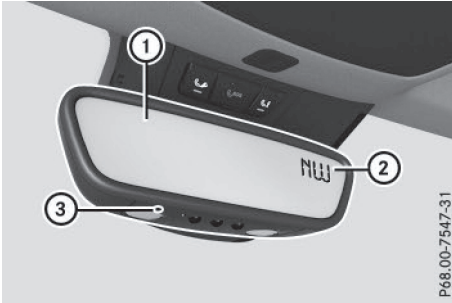

P68.00-7547-31

- ① Rear-view mirror
- ② Compass display
- ③ Opening

The compass displays in which compass direction the vehicle is currently traveling: **N, NE, E, SE, S, SW, W** or **NW**.

To receive a correct compass display reading, the magnetic field zone must be set and the compass calibrated.

Setting the compass

- ▶ Set your location using the magnetic field zone maps (▷ page 252).
- ▶ Push a round pen into opening ③ for approximately three seconds. The magnetic field zone currently selected appears in compass display ②.
- ▶ **To select the magnetic field zone:** push a round pen into opening ③ until the desired magnetic field zone is selected. If, after a few seconds, the display in compass display ② changes direction, the magnetic field zone has been selected.

Calibrating the compass

Notes

In order to calibrate the compass correctly, do the following:

- calibrate the compass in the open and not in the vicinity of steel structures or high-voltage transmission lines.
- switch off electrical consumers such as the climate control, windshield wipers or rear window defroster.
- close all doors and the trunk lid.

Calibrating

- ▶ Make sure that there is sufficient space for you to drive in a circle without impeding traffic.
- ▶ Switch on the ignition.
- ▶ Push a round pen into opening ③ for approximately six seconds, until symbol **C** is shown in compass display ②.
- ▶ Drive your vehicle in a full circle at approximately 3 mph (5 km/h) to 6 mph (10 km/h). When the calibration has been successfully completed, the current direction is shown in compass display ②.

Magnetic field zone maps

North America

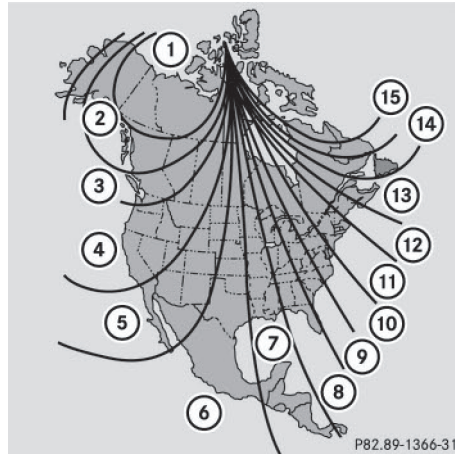

P82.89-1366-31

South America

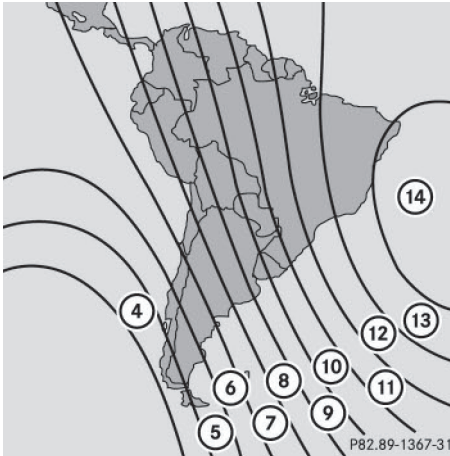

- ▶ Press safety catch knobs ① onto retainers ②.
- ▶ **To remove:** pull the floor mat off retainers ②.
- ▶ Remove the floor mat.

Floor mats

WARNING

Objects in the driver's footwell can restrict the pedal travel or obstruct a depressed pedal. The operating and road safety of the vehicle is jeopardized. There is a risk of an accident.

Make sure that all objects in the vehicle are stowed correctly, and that they cannot enter the driver's footwell. Install the floor mats securely and as specified in order to ensure sufficient clearance for the pedals. Do not use loose floor mats and do not place floor mats on top of one another.

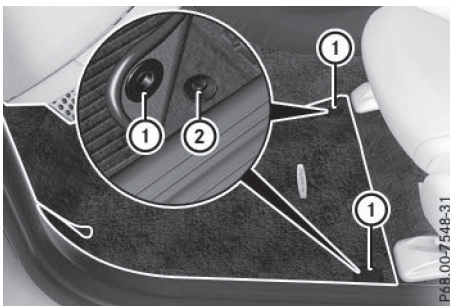

- ▶ Slide the seat backwards.
- ▶ **To install:** place the floor mat in the footwell.

Engine compartment

Hood

Important safety notes

WARNING

If the hood is unlatched, it may open up when the vehicle is in motion and block your view. There is a risk of an accident.

Never unlatch the hood while driving. Before every trip, ensure that the hood is locked.

WARNING

When opening and closing the hood, it may suddenly fall into the closed position. There is a risk of injury to persons within range of movement of the hood.

Open and close the hood only when no one is within its range of movement.

WARNING

Opening the hood when the engine is overheated or when there is a fire in the engine compartment could expose you to hot gases or other service products. There is a risk of injury.

Let an overheated engine cool down before opening the hood. If there is a fire in the engine compartment, keep the hood closed and contact the fire department.

WARNING

The engine compartment contains moving components. Certain components, such as the radiator fan, may continue to run or start again suddenly when the ignition is off. There is a risk of injury.

If you need to do any work inside the engine compartment:

- switch off the ignition
- never reach into the area where there is a risk of danger from moving components, such as the fan rotation area

- remove jewelry and watches
- keep items of clothing and hair, for example, away from moving parts

WARNING

The ignition system and the fuel injection system work under high voltage. If you touch components which are under voltage, you could get an electric shock. There is a risk of injury.

Never touch components of the ignition system or fuel injection system when the ignition is switched on.

Opening the hood

WARNING

Certain components in the engine compartment, such as the engine, radiator and parts of the exhaust system, can become very hot. Working in the engine compartment poses a risk of injury.

Where possible, let the engine cool down and touch only the components described in the following.

WARNING

When the hood is open and the windshield wipers are set in motion, you can be injured by the wiper linkage. There is a risk of injury.

Always switch off the windshield wipers and the ignition before opening the hood.

- ❗ Make sure that the windshield wipers are not folded away from the windshield. You could otherwise damage the windshield wipers or the hood.



- ▶ Make sure that the windshield wipers are switched off.
- ▶ Pull release lever ① on the hood. The hood is released.



- ▶ Reach into the gap between the hood and the radiator trim and press hood catch lever ② to the left.
- ▶ Raise the hood.

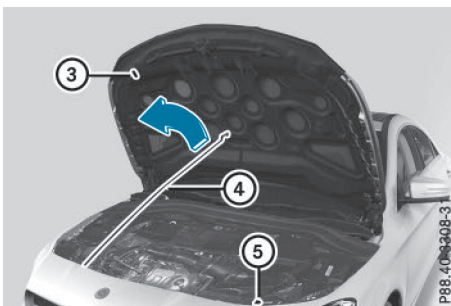

- ▶ Pull support strut ④ out of bracket ⑤.
- ▶ Lift up support strut ④ and insert it into yellow retaining clip ③.

Closing the hood

- ▶ Raise the hood slightly and, at the same time, remove support strut ④ from yellow retaining clip ③.
- ▶ Swing support strut ④ down and press it into bracket ⑤ until it engages.
- ▶ Lower the hood and let it fall from a height of approximately 8 in (20 cm).
- ▶ Check that the hood has engaged properly. If the hood can be raised slightly, it is not properly engaged. Do not press the hood closed. Open the hood again and close it with a little more force.

Engine oil

General notes

Depending on your driving style, the vehicle consumes up to 0.9 US qt (0.8 liters) of oil per 600 miles (1,000 km). The oil consumption may be higher than this when the vehicle is new or if you frequently drive at high engine speeds.

Depending on the engine, the oil dipstick may be in a different location.

When checking the oil level:

- park the vehicle on a level surface.
- the engine should be switched off for approximately five minutes if the engine is at normal operating temperature.
- if the engine is not at normal operating temperature, e.g. if the engine was only started briefly, wait about 30 minutes before carrying out the measurement.

Checking the oil level using the oil dipstick

WARNING

Certain components in the engine compartment, such as the engine, radiator and parts of the exhaust system, can become very hot. Working in the engine compartment poses a risk of injury.

Where possible, let the engine cool down and touch only the components described in the following.

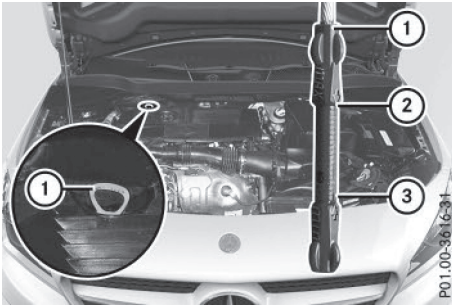

- ▶ Pull oil dipstick ① out of the dipstick guide tube.
- ▶ Wipe off oil dipstick ①.
- ▶ Slowly slide oil dipstick ① into the guide tube to the stop, and take it out again. If the level is between MIN mark ③ and MAX mark ②, the oil level is correct.
- ▶ If the oil level has dropped to MIN mark ③ or below, add 1.1 US qt (1.0 liter) engine oil.

Adding engine oil

WARNING

Certain components in the engine compartment, such as the engine, radiator and parts of the exhaust system, can become very hot. Working in the engine compartment poses a risk of injury.

Where possible, let the engine cool down and touch only the components described in the following.

WARNING

If engine oil comes into contact with hot components in the engine compartment, it may ignite. There is a risk of fire and injury.

Make sure that engine oil is not spilled next to the filler neck. Let the engine cool down and thoroughly clean the engine oil off the components before starting the engine.

Environmental note

When adding oil, take care not to spill any. If oil enters the soil or waterways, it is harmful to the environment.

- ❗ Use only engine oils and oil filters that are approved for vehicles with a service system. A list of the engine oils and oil filters that have been tested and approved in accordance with Mercedes-Benz Specifications for Service Products is available at any authorized Mercedes-Benz Center.

The following cause engine failure or damage to the exhaust system:

- Use of engine oils and oil filters that have not been expressly approved for the service system
- Replacement of engine oil and oil filter after the replacement interval specified by the service system has expired
- Use of engine oil additives

- ❗ Do not add too much oil. adding too much engine oil can result in damage to the engine or to the catalytic converter. Have excess engine oil siphoned off.

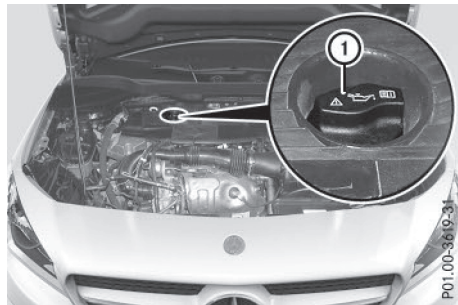

Example: engine oil cap

- ▶ Turn cap ① counter-clockwise and remove it.
- ▶ Add engine oil. If the oil level is at or below the MIN mark on the oil dipstick, add 1.1 US qt (1.0 liter) of engine oil.
- ▶ Replace cap ① on the filler neck and turn clockwise. Ensure that the cap locks into place securely.
- ▶ Check the oil level again with the oil dipstick (▷ page 255).

Further information on engine oil (▷ page 311).

Checking and adding other service products

Checking coolant level

⚠ WARNING

The cooling system is pressurized, particularly when the motor is warm. If you open the cap, you could be scalded if hot coolant sprays out. There is a risk of injury.

Let the engine cool down before you open the cap. Wear gloves and eye protection. Slowly open the cap to relieve pressure.

- ❗ The coolant may only be checked and corrected when the engine is cool (coolant temperature below 104 °F (40 °C)). Checking the coolant when the coolant temperature is above 104 °F (40 °C) may result in damage to the engine or to the engine cooling system.

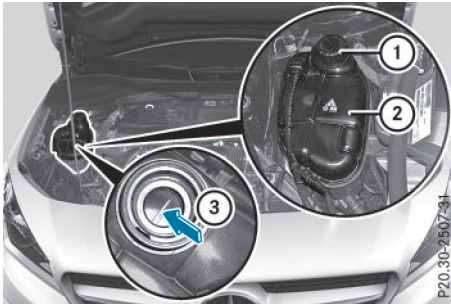

- ▶ Park the vehicle on a level surface. Only check the coolant level when the vehicle is on a level surface and the engine has cooled down.
- ▶ Turn the SmartKey to position **2** in the ignition lock (▷ page 121).
- ▶ Check the coolant temperature display in the instrument cluster. The coolant temperature must be below 104 °F (40 °C).
- ▶ Turn the SmartKey to position **0** (▷ page 121) in the ignition lock.
- ▶ Slowly turn cap **1** counter-clockwise and to relieve excess pressure.
- ▶ Turn cap **1** further counter-clockwise and remove it. If the coolant is at the level of marker bar **3** in the filler neck when cold, there is enough coolant in coolant expansion tank **2**.

- ▶ If necessary, add coolant that has been tested and approved by Mercedes-Benz.
- ▶ Replace cap **1** and turn it clockwise as far as it will go.

For further information on coolant, see (▷ page 312).

Windshield washer system

⚠ WARNING

Certain components in the engine compartment, such as the engine, radiator and parts of the exhaust system, can become very hot. Working in the engine compartment poses a risk of injury.

Where possible, let the engine cool down and touch only the components described in the following.

⚠ WARNING

Windshield washer concentrate could ignite if it comes into contact with hot engine components or the exhaust system. There is a risk of fire and injury.

Make sure that no windshield washer concentrate is spilled next to the filler neck.

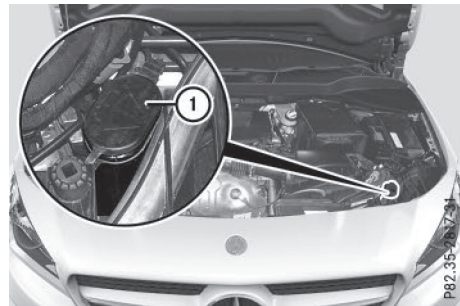

- ▶ **To open:** pull cap **1** upwards by the tab.
- ▶ Add the premixed washer fluid.
- ▶ **To close:** press cap **1** onto the filler neck until it engages.

If the washer fluid level drops below the recommended minimum of 1 liter, a message appears in the multifunction display prompting you to add washer fluid (▷ page 214).

Further information on windshield washer fluid/antifreeze (▷ page 313).

ASSYST PLUS

Service message

The ASSYST PLUS service interval display informs you of the next service due date.

You can find information on the type of service and service intervals in the Maintenance Booklet.

You can obtain further information from an authorized Mercedes-Benz Center or at <http://www.mbusa.com> (USA only).

- i** The ASSYST PLUS service interval display does not show any information on the engine oil level. Observe the notes on the engine oil level (▷ page 255).

The multifunction display shows a service message for several seconds, e.g.:

- Service A in .. days
- Service A due
- Service A overdue by .. days

Depending on the operating conditions of the vehicle, the remaining time or distance until the next service due date is displayed.

The letter **A** or **B**, possibly in connection with a number or another letter, indicates the type of service. **A** stands for a minor service and **B** for a major service.

You can obtain further information from an authorized Mercedes-Benz Center.

The ASSYST PLUS service interval display does not take into account any periods of time during which the battery is disconnected.

Maintaining the time-dependent service schedule:

- ▶ Note down the service due date displayed in the multifunction display before disconnecting the battery.

or

- ▶ After reconnecting the battery, subtract the battery disconnection periods from the service date shown on the display.

Hiding a service message

- ▶ Press the **OK** or **←** button on the steering wheel.

Displaying service messages

- ▶ Switch on the ignition.
- ▶ Press the **◀** or **▶** button to select the **Serv.** menu.
- ▶ Press the **▲** or **▼** button to select the **ASSYST PLUS** submenu and confirm by pressing the **OK** button.
The service due date appears in the multifunction display.

Information about Service

Resetting the ASSYST PLUS service interval display

- i** If the ASSYST PLUS service interval display has been inadvertently reset, this setting can be corrected at a qualified specialist workshop.

Have service work carried out as described in the Maintenance Booklet. This may otherwise lead to increased wear and damage to the major assemblies or the vehicle.

A qualified specialist workshop, e.g. an authorized Mercedes-Benz Center, will reset the ASSYST PLUS service interval display after the service work has been carried out. You can also obtain further information on maintenance work, for example.

Special service requirements

The specified maintenance interval takes only the normal operation of the vehicle into account. Under arduous operating conditions or increased load on the vehicle, maintenance work must be carried out more frequently, for example:

- regular city driving with frequent intermediate stops
- if the vehicle is primarily used to travel short distances
- use in mountainous terrain or on poor road surfaces
- if the engine is often left idling for long periods
- in particularly dusty conditions, or if air-recirculation mode is frequently used

In these or similar operating conditions, have the interior filter, engine air cleaner, engine oil and oil filter, for example, changed more fre-

quently. Under arduous operating conditions, the tires must be checked more often. Further information can be obtained at a qualified specialist workshop, e.g. an authorized Mercedes-Benz Center.

Driving abroad

An extensive Mercedes-Benz Service network is also available in other countries. You can obtain further information from any authorized Mercedes-Benz Center.

Care

General notes

Environmental note

Dispose of empty packaging and cleaning cloths in an environmentally responsible manner.

! For cleaning your vehicle, do not use any of the following:

- dry, rough or hard cloths
- abrasive cleaning agents
- solvents
- cleaning agents containing solvents

Do not scrub.

Do not touch the surfaces or protective films with hard objects, e.g. a ring or ice scraper. You could otherwise scratch or damage the surfaces and protective film.

! Do not park your vehicle for a long period of time directly after cleaning, particularly after cleaning the wheel rim with wheel cleaner. Wheel cleaner can lead to the increased corrosion of the brake discs and pads. Therefore, drive for a few minutes after cleaning. By heating up the brakes, the brake discs and pads dry. The vehicle can then be parked for a long period of time.

Regular care of your vehicle is a condition for retaining the quality in the long term.

Use care products and cleaning agents recommended and approved by Mercedes-Benz.

Washing the vehicle and cleaning the paintwork

Automatic car wash

WARNING

Braking efficiency is reduced after washing the vehicle. There is a risk of an accident.

After the vehicle has been washed, brake carefully while paying attention to the traffic conditions until full braking power is restored.

! When Distance Pilot DISTRONIC or the HOLD function is activated, the vehicle brakes automatically in certain situations. To avoid damage to the vehicle, deactivate Distance Pilot DISTRONIC and the HOLD function in the following or similar situations:

- when towing the vehicle
- in the car wash

! Never clean your vehicle in a Touchless Automatic Car Wash as these use special cleaning agents. These cleaning agents can damage the paintwork or plastic parts.

! Make sure that the automatic transmission is in position **N** when washing your vehicle in a tow-through car wash. The vehicle could be damaged if the transmission is in another position.

! Make sure that:

- the side windows and the sliding sunroof are fully closed.
 - the ventilation/heating is switched off (the OFF button has been pressed/the airflow control is set to position **0**).
 - the windshield wiper switch is in position **0**.
- Otherwise, the vehicle might be damaged.

You can wash the vehicle in an automatic car wash from the very start.

If the vehicle is very dirty, pre-wash it before cleaning it in an automatic car wash.

After using an automatic car wash, wipe off wax from the windshield and the wiper blades. This will prevent smears and reduce wiping noises caused by residue on the windshield.

Washing by hand

In some countries, washing by hand is only allowed at specially equipped washing bays. Observe the legal requirements in each country.

- ▶ Do not use hot water and do not wash the vehicle in direct sunlight.
- ▶ Use a soft sponge to clean.
- ▶ Use a mild cleaning agent, such as a car shampoo approved by Mercedes-Benz.
- ▶ Thoroughly hose down the vehicle with a gentle jet of water.
- ▶ Do not point the water jet directly towards the air inlet.
- ▶ Use plenty of water and rinse out the sponge frequently.
- ▶ Rinse the vehicle with clean water and dry thoroughly with a chamois.
- ▶ Do not let the cleaning agent dry on the paintwork.

Carefully remove all deposits of road salt as soon as possible when driving in winter.

Power washers

WARNING

The water jet from a circular jet nozzle (dirt blasters) can cause invisible exterior damage to the tires or chassis components. Components damaged in this way may fail unexpectedly. There is a risk of an accident.

Do not use power washers with circular jet nozzles to clean the vehicle. Have damaged tires or chassis components replaced immediately.

- ❗ Always maintain a distance of at least 11.8 in (30 cm) between the vehicle and the power washer nozzle. Information about the correct distance is available from the equipment manufacturer.

Move the power washer nozzle around when cleaning your vehicle.

Do not aim directly at any of the following:

- Tires
- Door gaps, roof gaps, joints, etc.
- Electrical components
- Battery
- Connectors

- Lamps
- Seals
- Trim
- Ventilation slots

Damaged seals or electrical components can lead to leaks or failures.

- ❗ Vehicles with decorative film: parts of your vehicle are covered with a decorative film. Maintain a distance of at least 27.5 in (70 cm) between the parts of the vehicle covered with the film and the nozzle of the high pressure cleaner.

Information about the correct distance is available from the equipment manufacturer.

Move the power washer nozzle around when cleaning your vehicle.

Cleaning the paintwork

- ❗ Do not affix:

- stickers
- films
- magnetic plates or similar items

to painted surfaces. You could otherwise damage the paintwork.

Scratches, corrosive deposits, areas affected by corrosion and damage caused by inadequate care cannot always be completely repaired. In such cases, visit a qualified specialist workshop.

- ▶ Remove dirt immediately, where possible, while avoiding rubbing too hard.
- ▶ Soak insect remains with insect remover and rinse off the treated areas afterwards.
- ▶ Soak bird droppings with water and rinse off the treated areas afterwards.
- ▶ Remove coolant, brake fluid, tree resin, oils, fuels and greases by rubbing gently with a cloth soaked in petroleum ether or lighter fluid.
- ▶ Use tar remover to remove tar stains.
- ▶ Use silicone remover to remove wax.

If water no longer forms "beads" on the paint surface, use the paint care products recommended and approved by Mercedes-Benz. This is the case approximately every three to five months, depending on the climate conditions and the care product used.

If dirt has penetrated the paint surface or if the paint has become dull, the paint cleaner recom-

mended and approved by Mercedes-Benz should be used.

Do not use these care products in the sun or on the hood while the hood is hot.

- ▶ Use a suitable touch-up stick, e.g. MB Touch-Up Stick, to repair slight damage to the paintwork quickly and provisionally.

Matte finish care

! Never polish the vehicle or the light alloy wheels. Polishing causes the finish to shine.

! The following may cause the paint to become shiny and thus reduce the matte effect:

- strong rubbing of the paintwork with unsuitable materials
- frequent use of automatic car washes
- washing the vehicle in direct sunlight

! Never use paint cleaner, buffing or polishing products, or gloss preserver, e.g. wax, for the purpose of paintwork care. These products are only suitable for high-gloss surfaces. Their use on vehicles with matte paintwork leads to considerable surface damage or, more specifically, to shiny, spotted areas.

Always have paintwork repairs carried out at a qualified specialist workshop.

! Do not use wash programs with a hot wax treatment under any circumstances.

Observe these notes if your vehicle has a clear matte finish. This will help you to avoid damage to the paintwork due to incorrect treatment.

These notes also apply to light alloy wheels with a clear matte finish.

The vehicle should ideally be washed by hand using a soft sponge, car shampoo and plenty of water.

Use only insect remover and car shampoo from the range of approved Mercedes-Benz care products.

Cleaning the vehicle parts

Cleaning the wheels

WARNING

The water jet from a circular jet nozzle (dirt blasters) can cause invisible exterior damage to the tires or chassis components. Components damaged in this way may fail unexpectedly. There is a risk of an accident.

Do not use power washers with circular jet nozzles to clean the vehicle. Have damaged tires or chassis components replaced immediately.

! Do not use acidic wheel cleaning products to remove brake dust. This could damage wheel bolts and brake components.

! Do not park your vehicle for a long period of time directly after cleaning, particularly after cleaning the wheel rim with wheel cleaner. Wheel cleaner can lead to the increased corrosion of the brake discs and pads. Therefore, drive for a few minutes after cleaning. By heating up the brakes, the brake discs and pads dry. The vehicle can then be parked for a long period of time.

Cleaning the windows

WARNING

You could become trapped by the windshield wipers if they start moving while cleaning the windshield or wiper blades. There is a risk of injury.

Always switch off the windshield wipers and the ignition before cleaning the windshield or wiper blades.

! Only fold the windshield wipers away from the windshield when vertical. Otherwise, you will damage the hood.

! Do not use dry cloths, abrasive products, solvents or cleaning agents containing solvents to clean the inside of the windows. Do not touch the insides of the windows with hard objects, e.g. an ice scraper or ring. There is otherwise a risk of damaging the windows.

- ❗ Clean the water drainage channels of the windshield and the rear window at regular intervals. Deposits such as leaves, petals and pollen may under certain circumstances prevent water from draining away. This can lead to corrosion damage and damage to electronic components.
- ▶ Clean the inside and outside of the windows with a damp cloth and a cleaning product that is recommended and approved by Mercedes-Benz.

Cleaning wiper blades

⚠ WARNING

You could become trapped by the windshield wipers if they start moving while cleaning the windshield or wiper blades. There is a risk of injury.

Always switch off the windshield wipers and the ignition before cleaning the windshield or wiper blades.

- ❗ Only fold the windshield wipers away from the windshield when vertical. Otherwise, you will damage the hood.
- ❗ Do not pull the wiper blade. Otherwise, the wiper blade could be damaged.
- ❗ Do not clean wiper blades too often and do not rub them too hard. Otherwise, the graphite coating could be damaged. This could cause wiper noise.
- ❗ Hold the wiper arm securely when folding back. The windshield could be damaged if the wiper arm smacks against it suddenly.
- ▶ Fold the windshield wiper arms away from the windshield.
- ▶ Carefully clean the wiper blades with a damp cloth.
- ▶ Fold the windshield wiper arms back again before switching on the ignition.

Cleaning the exterior lighting

- ❗ Only use cleaning agents or cleaning cloths which are suitable for plastic light lenses. Unsuitable cleaning agents or cleaning cloths could scratch or damage the plastic light lenses.

- ▶ Clean the plastic lenses of the exterior lights with a wet sponge and a mild cleaning agent, e.g. Mercedes-Benz car shampoo or cleaning cloths.

Cleaning the mirror turn signals

- ❗ Only use cleaning agents or cleaning cloths that are suitable for plastic lenses. Unsuitable cleaning agents or cleaning cloths could scratch or damage the plastic lenses of the mirror turn signals.
- ▶ Clean the plastic lenses of the mirror turn signals in the exterior mirror housing using a wet sponge and mild cleaning agent, e.g. Mercedes-Benz car shampoo or cleaning cloths.

Cleaning the sensors

- ❗ If you clean the sensors with a power washer, make sure that you keep a distance of at least 11.8 in (30 cm) between the vehicle and the power washer nozzle. Information about the correct distance is available from the equipment manufacturer.

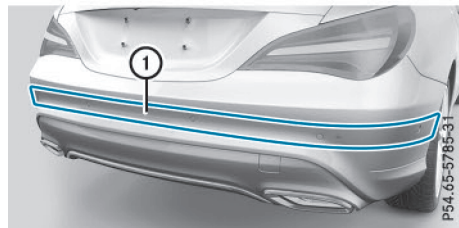

- ▶ Clean sensors ① of the driving systems with water, car shampoo and a soft cloth.

Cleaning the rear view camera

- ❗ Do not clean the camera lens and the area around the rear view camera with a power washer.

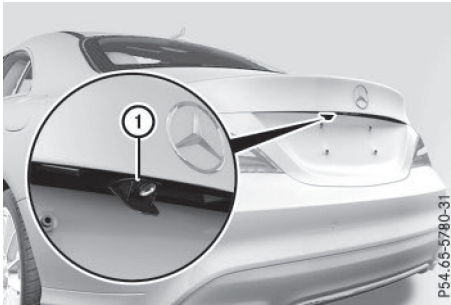

PS4_65-5780-31

- ▶ Make sure that the vehicle is stationary and that the SmartKey is in position **2** in the ignition lock.
- ▶ Open the camera cover for cleaning via the multimedia system (see the separate operating instructions).
- ▶ **To clean the rear view camera:** use clear water and a soft cloth to clean camera lens ①.

Cleaning the exhaust pipes

WARNING

The exhaust tail pipe and tail pipe trim can become very hot. If you come into contact with these parts of the vehicle, you could burn yourself. There is a risk of injury.

Always be particularly careful around the exhaust tail pipe and the tail pipe trim. Allow these components to cool down before touching them.

- ❗ Do not clean the exhaust pipe with acid-based cleaning agents, such as bathroom cleaner or wheel cleaner.
- ❗ Mercedes-AMG vehicles with black exhaust pipes: the black-chrome tailpipe finishers should not be polished with a chrome polish. They will otherwise lose their black sheen. For optimal care, the faceplates should be rubbed with a lightly oiled cloth after every car wash. Commercially available engine and care oils are suitable for this.

For heavier soiling, you can apply a fine paintwork polish with a microfiber cloth. Remove the excess polish residue after polishing.

Impurities combined with the effects of road grit and corrosive environmental factors may cause flash rust to form on the surface. You can

restore the original shine of the exhaust pipe by cleaning it regularly, especially in winter and after washing.

- ▶ Clean the exhaust pipe with a care product tested and approved by Mercedes-Benz.

Interior care

Cleaning the display

❗ For cleaning, do not use any of the following:

- alcohol-based thinner or gasoline
- abrasive cleaning agents
- commercially-available household cleaning agents

These may damage the display surface. Do not put pressure on the display surface when cleaning. This could lead to irreparable damage to the display.

- ▶ Before cleaning the display, make sure that it is switched off and has cooled down.
- ▶ Clean the display surface using a commercially available microfiber cloth and TFT/LCD display cleaner.
- ▶ Dry the display surface using a dry microfiber cloth.

Cleaning the plastic trim

WARNING

Care products and cleaning agents containing solvents cause surfaces in the cockpit to become porous. As a result, plastic parts may come loose in the event of air bag deployment. There is a risk of injury.

Do not use any care products and cleaning agents to clean the cockpit.

❗ Do not affix the following to plastic surfaces:

- stickers
- films
- scented oil bottles or similar items

You can otherwise damage the plastic.

❗ Do not allow cosmetics, insect repellent or sunscreen to come into contact with the plastic trim. This maintains the high-quality look of the surfaces.

- ▶ Wipe the plastic trim with a damp, lint-free cloth, e.g. a microfiber cloth.
- ▶ **Heavy soiling:** use care and cleaning products recommended and approved by Mercedes-Benz. The surface may change color temporarily. Wait until the surface is dry again.

Cleaning the steering wheel and gear or selector lever

- ▶ Thoroughly wipe with a damp cloth or use leather care agents that have been recommended and approved by Mercedes-Benz.

Cleaning genuine wood and trim elements

❗ Do not use solvent-based cleaning agents such as tar remover, wheel cleaners, polishes or waxes. There is otherwise a risk of damaging the surface.

❗ Do not use chrome polish on trim pieces. The trim pieces have a chrome look but are mostly made of anodized aluminum and can lose their shine if chrome polish is used. Use a damp, lint-free cloth instead when cleaning the trim pieces.

If the chrome-plated trim pieces are very dirty, you can use a chrome polish. If you are unsure as to whether the trim pieces are chrome-plated or not, consult an authorized Mercedes-Benz Center.

- ▶ Wipe the wooden trim and trim pieces with a damp, lint-free cloth, e.g. a microfiber cloth.
- ▶ **Heavy soiling:** use care and cleaning products recommended and approved by Mercedes-Benz.

Cleaning the seat covers

General notes

❗ Do not use a microfiber cloth to clean covers made out of real leather, artificial leather or DINAMICA. If used often, these can damage the cover.

Note that regular care is essential to ensure that the appearance and comfort of the covers is retained over time.

Genuine leather seat covers

❗ To retain the natural appearance of the leather, observe the following cleaning instructions:

- Clean genuine leather covers carefully with a damp cloth and then wipe the covers down with a dry cloth.
- Make sure that the leather does not become soaked. It may otherwise become rough and cracked.
- Only use leather care agents that have been tested and approved by Mercedes-Benz. You can obtain these from a qualified specialist workshop.

Leather is a natural product.

It exhibits natural surface characteristics, for example:

- differences in the texture
- marks caused by growth and injury
- slight nuances of color

These are characteristics of leather and not material defects.

Seat covers of other materials

❗ Observe the following when cleaning:

- clean artificial leather covers with a cloth moistened with a solution containing 1% detergent (e.g. dish washing liquid).
- clean cloth covers with a microfiber cloth moistened with a solution containing 1% detergent (e.g. dish washing liquid). Rub carefully and always wipe entire seat sections to avoid leaving visible lines. Leave the seat to dry afterwards. Cleaning results depend on the type of dirt and how long it has been there.
- clean DINAMICA covers with a damp cloth. Make sure that you wipe entire seat sections to avoid leaving visible lines.

Cleaning the seat belts

WARNING

Seat belts can become severely weakened if bleached or dyed. This could cause the seat belts to tear or fail, for instance, in the event of an accident. This poses an increased risk of injury or fatal injury.

Never bleach or dye the seat belts.

! Do not clean the seat belts using chemical cleaning agents. Do not dry the seat belts by heating at temperatures above 176 °F (80 °C) or in direct sunlight.

- ▶ Use clean, lukewarm water and soap solution.

Cleaning the headliner and carpets

- ▶ **Headliner:** if it is very dirty, use a soft brush or dry shampoo.
- ▶ **Carpets:** use the carpet and textile cleaning agents recommended and approved by Mercedes-Benz.

Where will I find...?

Vehicle tool kit

General notes

Vehicles with a TIREFIT kit: the TIREFIT kit is located in the stowage well under the trunk floor.

Vehicles with a tire-change tool kit: the tire-change tool kit is in the stowage well under the trunk floor.

Apart from certain country-specific variations, the vehicles are not equipped with a tire-change tool kit. Some tools for changing a wheel are specific to the vehicle. For more information on which tire changing tools are required and approved to perform a wheel change on your vehicle, consult a qualified specialist workshop.

Tools required for changing a wheel may include, for example:

- Jack
- Wheel chock
- Lug wrench
- Alignment bolt

Vehicles with a TIREFIT kit

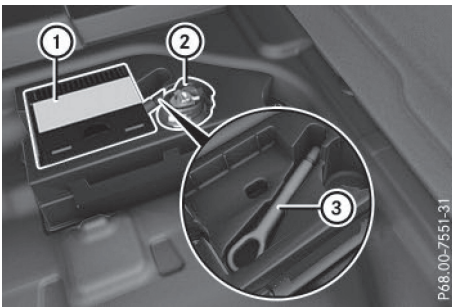

- ① Tire inflation compressor
- ② Tire sealant filler bottle
- ③ Towing eye

- ▶ Open the trunk lid.
- ▶ Lift the trunk floor upwards (▷ page 237).
- ▶ Use the TIREFIT kit (▷ page 268) or remove it. Towing eye ③ is located under tire inflation compressor ①.

Vehicles with a tire-change tool kit

- ▶ Open the trunk lid.
- ▶ Lift the trunk floor upwards (▷ page 237).
- ▶ Remove the tire-change tool kit.

The tire-change tool kit contains:

- Jack
- Lug wrench
- One pair of gloves
- Folding wheel chock

Flat tire

Preparing the vehicle

Your vehicle may be equipped with:

- MOExtended tires (tires with run-flat properties) (▷ page 267)
- Vehicle preparation is not necessary on vehicles with MOExtended tires
- a TIREFIT kit (▷ page 266)

Vehicles equipped with MOExtended tires are not equipped with a TIREFIT kit at the factory. It is therefore recommended that you additionally equip your vehicle with a TIREFIT kit if you mount tires that do not feature run-flat properties, e.g. winter tires. A TIREFIT kit may be obtained from a qualified specialist workshop.

Information on changing and mounting wheels (▷ page 301).

- ▶ Stop the vehicle on solid, non-slippery and level ground, as far away as possible from traffic.
- ▶ Switch on the hazard warning lamps.
- ▶ Secure the vehicle against rolling away (▷ page 140).
- ▶ If possible, bring the front wheels into the straight-ahead position.
- ▶ Switch off the engine.
- ▶ **Vehicles without KEYLESS-GO:** remove the SmartKey from the ignition lock.
- ▶ **Vehicles with KEYLESS-GO start-function or KEYLESS-GO:** open the driver's door. The vehicle electronics now have status **0**. This is the same as the SmartKey having been removed.
- ▶ **Vehicles with KEYLESS-GO start-function or KEYLESS-GO:** remove the Start/Stop button from the ignition lock (▷ page 121).

- ▶ Make sure that the engine cannot be started via your smartphone (▷ page 122).
- ▶ Make sure that the passengers are not endangered as they do so. Make sure that no one is near the danger area while a wheel is being changed. Anyone who is not directly assisting in the wheel change should, for example, stand behind the barrier.
- ▶ Get out of the vehicle. Pay attention to traffic conditions when doing so.
- ▶ Close the driver's door.

MOExtended tires (tires with run-flat properties)

General notes

With MOExtended tires (tires with run flat characteristics), you can continue to drive your vehicle even if there is a total loss of pressure in one or more tires. The affected tire must not show any clearly visible damage.

You can recognize MOExtended tires by the MOExtended marking which appears on the sidewall of the tire. You will find this marking next to the tire size designation, the load-bearing capacity and the speed index (▷ page 296).

MOExtended tires may be used only in conjunction with an activated tire pressure loss warning system (Canada only) or tire pressure monitor (USA only).

If a pressure loss warning message appears in the multifunction display:

- observe the instructions in the display messages (▷ page 209).
- check the tire for damage.
- if driving on, observe the following notes.

The driving distance possible in run-flat mode is approximately 50 miles (80 km) when the vehicle is partially laden. When the vehicle is fully laden it is approximately 19 miles (30 km).

In addition to the vehicle load, the driving distance possible depends upon:

- Vehicle speed
- Road condition
- Outside temperature

The driving distance possible in run-flat mode may be reduced by extreme driving conditions or maneuvers, or it can be increased through a moderate style of driving.

The driving distance possible in run-flat mode is counted from the moment the tire pressure loss warning appears in the multifunction display.

You must not exceed a maximum speed of 50 mph (80 km/h).

When replacing one or all tires, please observe the following specifications for your vehicle's tires:

- size
- type and
- the "MOExtended" marking

If a tire has gone flat and cannot be replaced with a MOExtended tire, a standard tire may be used as a temporary measure. Make sure that you use the proper size and type (summer or winter tire).

Vehicles equipped with MOExtended tires are not equipped with a TIREFIT kit at the factory. It is therefore recommended that you additionally equip your vehicle with a TIREFIT kit if you mount tires that do not feature run-flat properties, e.g. winter tires. A TIREFIT kit may be obtained from a qualified specialist workshop.

Important safety notes

WARNING

When driving in emergency mode, the driving characteristics deteriorate, e.g. when cornering, accelerating quickly and when braking. There is a risk of an accident.

Do not exceed the stated maximum speed. Avoid abrupt steering and driving maneuvers, and driving over obstacles (curbs, potholes, off-road). This applies in particular to a laden vehicle.

Stop driving in emergency mode if:

- you hear banging noises.
- the vehicle starts to shake.
- you see smoke and smell rubber.
- ESP® is intervening constantly.
- there are tears in the sidewalls of the tire.

After driving in emergency mode, have the wheel rims checked at a qualified specialist workshop with regard to their further use. The defective tire must be replaced in every case.

TIREFIT kit**Important safety notes**

TIREFIT is a tire sealant.

You can use TIREFIT to seal punctures of up to 0.16 in (4 mm), particularly those in the tire tread. You can use TIREFIT at outside temperatures down to -4 °F (-20 °C).

⚠ WARNING

In the following situations, the tire sealant is unable to provide sufficient breakdown assistance, as it is unable to seal the tire properly:

- there are cuts or punctures in the tire larger than those mentioned above.
- the wheel rim is damaged.
- you have driven at very low tire pressures or on a flat tire.

There is a risk of an accident.

Do not drive the vehicle. Contact a qualified specialist workshop.

⚠ WARNING

The tire sealant is harmful and causes irritation. It must not come into contact with your skin, eyes or clothing or be swallowed. Do not inhale TIREFIT fumes. Keep tire sealant away from children. There is a risk of injury.

If you come into contact with the tire sealant, observe the following:

- Rinse off the tire sealant from your skin immediately with water.
- If the tire sealant comes into contact with your eyes, immediately rinse them thoroughly with clean water.
- If tire sealant is swallowed, immediately rinse your mouth out thoroughly and drink plenty of water. Do not induce vomiting, and seek medical attention immediately.
- Immediately change out of clothing which has come into contact with tire sealant.
- If an allergic reaction occurs, seek medical attention immediately.

- ❗ Residue from the tire sealant may come out of the filler hose after use. This could cause stains.

Therefore, place the filler hose in the plastic bag which contained the TIREFIT kit.

♻ Environmental note

Have the used tire sealant bottle disposed of professionally, e.g. at a qualified specialist workshop.

- ❗ Do not operate the tire inflation compressor for longer than ten minutes at a time without a break. It may otherwise overheat.

The tire inflation compressor can be operated again once it has cooled down.

Comply with the manufacturer's safety instructions on the sticker on the tire inflation compressor.

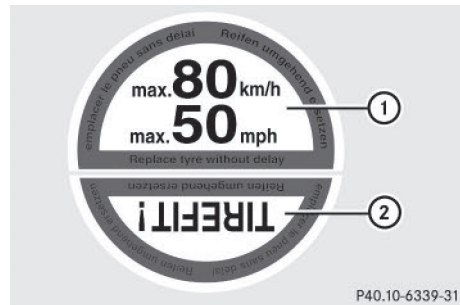
Using the TIREFIT kit

- ▶ Do not remove any foreign objects which have penetrated the tire, e.g. screws or nails.
- ▶ Remove the tire sealant bottle, the accompanying TIREFIT sticker and the tire inflation compressor from the stowage well underneath the trunk floor (▷ page 266).
- ▶ Affix part ① of the TIREFIT sticker to the instrument cluster within the driver's field of vision.
- ▶ Affix part ② of the TIREFIT sticker near the valve on the wheel with the defective tire.

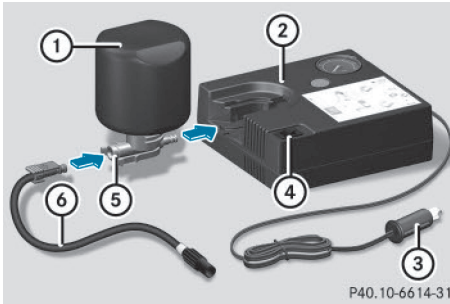

P40.10-6614-31

- ▶ Remove filler hose (6) and connector (3) from the bottom section of the tire inflation compressor housing (2).
- ▶ Slide the yellow filler hose connector into the mounting on yellow cap (5) of tire sealant filler bottle (1) until the connector engages.
- ▶ With the sealing rings in front, slide yellow cap (5) of tire sealant bottle (1) into the mounting of tire inflation compressor (2). Yellow cap (5) and both hooks must engage.

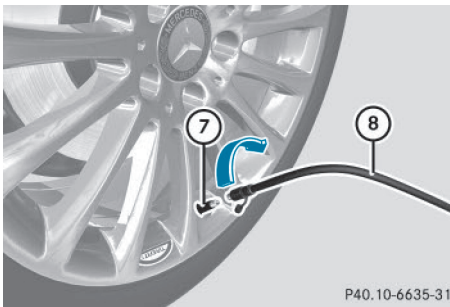

P40.10-6635-31

- ▶ Remove the cap from valve (7) on the faulty tire.
- ▶ Screw filler hose (8) onto valve (7).
- ▶ Insert plug (3) into a 12 V socket in your vehicle. Observe the notes on sockets (▷ page 241).
- ▶ Turn the SmartKey to position 1 in the ignition lock (▷ page 121).
- ▶ Press on and off switch (4) on the tire inflation compressor to **ON**. The tire inflation compressor is switched on. The tire is inflated.

First, tire sealant is pumped into the tire. The pressure can briefly rise to approximately 500 kPa (5 bar/73 psi).

Do not switch off the tire inflation compressor during this phase.

- ▶ Let the tire inflation compressor run for a maximum of ten minutes. The tire should then have attained a pressure of at least 200 kPa (2.0 bar/29 psi).

If a pressure of 200 kPa (2.0 bar/29 psi) has been attained after five minutes, see "Tire pressure reached" (▷ page 270).

If a tire pressure of 200 kPa (2.0 bar/29 psi) has not been attained after five minutes, see "Tire pressure not reached" (▷ page 269).

If tire sealant has escaped, clean it off affected areas as quickly as possible. Use plain water if possible.

If your clothes are soiled with tire sealant, have them cleaned with perchloroethylene at a dry cleaner as soon as possible.

Tire pressure not reached

If a tire pressure of 200 kPa (2.0 bar/29 psi) has not been attained after ten minutes:

- ▶ Switch off the tire inflation compressor.
- ▶ Unscrew the filler hose from the valve of the faulty tire. Note that tire sealant may escape when you unscrew the filler hose.
- ▶ Very slowly drive forwards or reverse approximately 30 ft (10 m).
- ▶ Pump up the tire again. After a maximum of ten minutes, the tire pressure must be at least 200 kPa (2.0 bar/29 psi).

⚠ WARNING

If the required tire pressure is not reached after the specified time, the tire is too badly damaged. The tire sealant cannot repair the tire in this instance. Damaged tires and a tire pressure that is too low can significantly impair the vehicle's braking and driving characteristics. There is a risk of accident.

Do not continue driving. Contact a qualified specialist workshop.

Tire pressure reached

WARNING

A tire temporarily sealed with tire sealant impairs the driving characteristics and is not suitable for higher speeds. There is a risk of accident.

You should therefore adapt your driving style accordingly and drive carefully. Do not exceed the specified maximum speed with a tire that has been repaired using tire sealant.

The maximum permissible speed for a tire sealed with tire sealant is 50 mph (80 km/h). The upper part of the TIREFIT sticker must be affixed to the instrument cluster in the driver's field of vision.

If a tire pressure of 200 kPa (2.0 bar/29 psi) has been attained after ten minutes:

- ▶ Switch off the tire inflation compressor.
- ▶ Unscrew the filler hose from the valve of the faulty tire.
 - Note that tire sealant may escape when you unscrew the filler hose.
- ▶ Stow the tire sealant bottle and the tire inflation compressor.
- ▶ **Pull away immediately.**
- ▶ Stop after driving for approximately ten minutes and check the tire pressure with the tire inflation compressor.
 - The tire pressure must now be at least 130 kPa (1.3 bar/19 psi).

WARNING

If the required tire pressure is not reached after driving for a short period, the tire is too badly damaged. The tire sealant cannot repair the tire in this instance. Damaged tires and a tire pressure that is too low can significantly impair the vehicle's braking and driving characteristics. There is a risk of accident.

Do not continue driving. Contact a qualified specialist workshop.

-  In cases such as the one mentioned above, contact an authorized Mercedes-Benz Center. Or call 1-800-FOR-MERCEDES (in the USA) or 1-800-387-0100 (in Canada).

- ▶ Correct the tire pressure if it is still at least 130 kPa (1.3 bar/19 psi). See the Tire and Loading Information placard on the driver's side B-pillar or the tire pressure table in the fuel filler flap for values.
- ▶ **To increase the tire pressure:** switch on the tire inflation compressor.

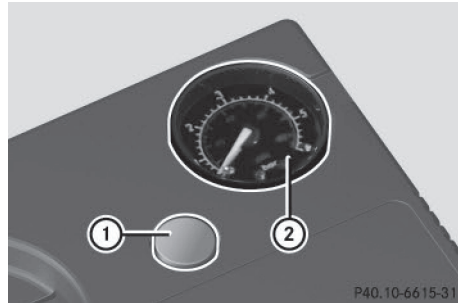

- ▶ When the tire pressure is correct, unscrew the filler hose from the valve of the sealed tire. Note that tire sealant may escape when you unscrew the filler hose.
- ▶ Screw the valve cap onto the tire valve of the sealed tire.

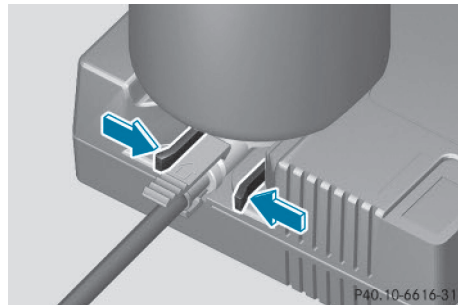

- ▶ To remove the tire sealant bottle from the tire inflation compressor, press together the locking tabs on the yellow cap.
- ▶ Pull the tire sealant bottle out of the tire inflation compressor.
 - The filler hose remains attached to the tire sealant bottle.
- ▶ Drive to the nearest qualified specialist workshop and have the tire changed there.
- ▶ Have the tire sealant bottle and the filler hose replaced as soon as possible at a qualified specialist workshop.
- ▶ Have the tire sealant bottle replaced every four years at a qualified specialist workshop.

Battery (vehicle)

Important safety notes

Special tools and expert knowledge are required when working on the battery, e.g. removal and installation. You should therefore have all work involving the battery carried out at a qualified specialist workshop.

WARNING

Work carried out incorrectly on the battery can lead, for example, to a short circuit and thus damage the vehicle electronics. This can lead to function restrictions applying to safety-relevant systems, e.g. the lighting system, the ABS (anti-lock braking system) or the ESP® (Electronic Stability Program). The operating safety of your vehicle may be restricted. You could lose control of the vehicle, for example:

- when braking
- in the event of abrupt steering maneuvers and/or when the vehicle's speed is not adapted to the road conditions

There is a risk of an accident.

In the event of a short circuit or a similar incident, contact a qualified specialist workshop immediately. Do not drive any further. You should have all work involving the battery carried out at a qualified specialist workshop.

For further information about ABS and ESP®, see (> page 60) and (> page 63).

WARNING

Electrostatic build-up can lead to the creation of sparks, which could ignite the highly explosive gases of a battery. There is a risk of an explosion.

Before handling the battery, touch the vehicle body to remove any existing electrostatic build-up.

The highly flammable gas mixture forms when charging the battery as well as when jump-starting.

Always make sure that neither you nor the battery is electrostatically charged. A build-up of electrostatic charge can be caused, for example:

- by wearing clothing made from synthetic fibers
- due to friction between clothing and seats
- if you push or pull the battery across the carpet or other synthetic materials
- if you rub the battery with a cloth

WARNING

During the charging process, a battery produces hydrogen gas. If a short circuit occurs or sparks are created, the hydrogen gas can ignite. There is a risk of an explosion.

- Make sure that the positive terminal of a connected battery does not come into contact with vehicle parts.
- Never place metal objects or tools on a battery.
- It is important that you observe the described order of the battery terminals when connecting and disconnecting a battery.
- When jump-starting, make sure that the battery poles with identical polarity are connected.
- It is particularly important to observe the described order when connecting and disconnecting the jumper cables.
- Never connect or disconnect the battery terminals while the engine is running.

WARNING

Battery acid is caustic. There is a risk of injury. Avoid contact with skin, eyes or clothing. Do not inhale any battery gases. Do not lean over the battery. Keep children away from batteries. Wash away battery acid immediately with plenty of clean water and seek medical attention.

Environmental note



Batteries contain dangerous substances. It is against the law to dispose of them with



the household rubbish. They must be collected separately and recycled to protect the environment.

Dispose of batteries in an environmentally friendly manner. Take discharged batteries to a qualified specialist workshop or a special collection point for used batteries.

- ❗ Have the battery checked regularly at a qualified specialist workshop. Observe the service intervals in the Maintenance Booklet or contact a qualified specialist workshop for more information.

- ❗ You should have all work involving the battery carried out at a qualified specialist workshop. In the exceptional case that it is necessary for you to disconnect the battery yourself, make sure that:

- you switch off the engine and remove the key. On vehicles with KEYLESS-GO, ensure that the ignition is switched off. Check that all the indicator lamps in the instrument cluster are off. Otherwise, electronic components, such as the alternator, may be damaged.
- you first remove the negative terminal clamp and then the positive terminal clamp. Never swap the terminal clamps. Otherwise, the vehicle's electronic system may be damaged.
- in vehicles with automatic transmission, the transmission is locked in position **P** after disconnecting the battery. The vehicle is secured against rolling away. You can then no longer move the vehicle.

The battery and the cover of the positive terminal clamp must be installed securely during operation.

Comply with safety precautions and take protective measures when handling batteries.



Risk of explosion.



Fire, open flames and smoking are prohibited when handling the battery. Avoid creating sparks.



Battery acid is caustic. Avoid contact with skin, eyes or clothing.

Wear suitable protective clothing, especially gloves, apron and face-guard.

Rinse any acid spills immediately with clear water. Contact a physician if necessary.



Wear eye protection.



Keep children away.



Observe this Operator's Manual.

For safety reasons, Mercedes-Benz recommends that you only use batteries which have been tested and approved for your vehicle by Mercedes-Benz. These batteries provide increased impact protection to prevent vehicle occupants from suffering acid burns should the battery be damaged in the event of an accident. In order for the battery to achieve the maximum possible service life, it must always be sufficiently charged.

Like other batteries, the vehicle battery may discharge over time if you do not use the vehicle. In this case, have the battery disconnected at a qualified specialist workshop. You can also charge the battery with a charger recommended by Mercedes-Benz. Contact a qualified specialist workshop for further information.

Have the battery condition of charge checked more frequently if you use the vehicle mainly for short trips or if you leave it standing idle for a lengthy period. Consult a qualified specialist workshop if you wish to leave your vehicle parked for a long period of time.

Only replace a battery with a battery that has been recommended by Mercedes-Benz.

Remove the SmartKey if you park the vehicle and do not require any electrical consumers. The vehicle will then use very little energy, thus conserving battery power.

If the power supply has been interrupted, e.g. if you reconnect the battery, you will have to:

- set the clock using the multimedia system; see the separate operating instructions.
- reset the function for folding the exterior mirrors in/out automatically, by folding the mirrors out once (▷ page 96)

Charging the battery

WARNING

During charging and jump-starting, explosive gases can escape from the battery. There is a risk of an explosion.

Particularly avoid fire, open flames, creating sparks and smoking. Ensure there is sufficient ventilation while charging and jump-starting. Do not lean over a battery.

WARNING

Battery acid is caustic. There is a risk of injury. Avoid contact with skin, eyes or clothing. Do not inhale any battery gases. Do not lean over the battery. Keep children away from batteries. Wash away battery acid immediately with plenty of clean water and seek medical attention.

WARNING

A discharged battery can freeze at temperatures below freezing point. When jump-start-

ing the vehicle or charging the battery, gases can escape from the battery. There is a risk of an explosion.

Allow the frozen battery to thaw out before charging it or jump-starting.

 Only use battery chargers with a maximum charging voltage of 14.8 V.

 Only charge the battery using the jump-starting connection point.

The jump-starting connection point is in the engine compartment (▷ page 273).

▶ Open the hood.

▶ Connect the battery charger to the positive terminal and ground point in the same order as when connecting the donor battery in the jump-starting procedure (▷ page 273).

If the indicator/warning lamps do not light up in the instrument cluster at low temperatures, it is very likely that the discharged battery has frozen. In this case you may neither jump-start the vehicle nor charge the battery. The service life of a thawed-out battery may be shorter. The starting characteristics can be impaired, particularly at low temperatures. Have the thawed-out battery checked at a qualified specialist workshop.

Only charge the installed battery with a battery charger which has been tested and approved by Mercedes-Benz. A battery charger unit specially adapted for Mercedes-Benz vehicles and tested and approved by Mercedes-Benz is available as an accessory. It permits the charging of the battery in its installed position. Contact an authorized Mercedes-Benz Center for further information and availability. Read the battery charger's operating instructions before charging the battery.

Jump-starting

For the jump-starting procedure, use only the jump-starting connection point, consisting of a positive terminal and a ground point, in the engine compartment.

WARNING

Battery acid is caustic. There is a risk of injury.

Avoid contact with skin, eyes or clothing. Do not inhale any battery gases. Do not lean over the battery. Keep children away from batteries. Wash away battery acid immediately with plenty of clean water and seek medical attention.

 **WARNING**

During charging and jump-starting, explosive gases can escape from the battery. There is a risk of an explosion.

Particularly avoid fire, open flames, creating sparks and smoking. Ensure there is sufficient ventilation while charging and jump-starting. Do not lean over a battery.

 **WARNING**

During the charging process, a battery produces hydrogen gas. If a short circuit occurs or sparks are created, the hydrogen gas can ignite. There is a risk of an explosion.

- Make sure that the positive terminal of a connected battery does not come into contact with vehicle parts.
- Never place metal objects or tools on a battery.
- It is important that you observe the described order of the battery terminals when connecting and disconnecting a battery.
- When jump-starting, make sure that the battery poles with identical polarity are connected.
- It is particularly important to observe the described order when connecting and disconnecting the jumper cables.
- Never connect or disconnect the battery terminals while the engine is running.

 **WARNING**

A discharged battery can freeze at temperatures below freezing point. When jump-starting the vehicle or charging the battery, gases can escape from the battery. There is a risk of an explosion.

Allow the frozen battery to thaw out before charging it or jump-starting.

- ❗ **Avoid repeated and lengthy starting attempts. Otherwise, the catalytic converter could be damaged by the non-combusted fuel.**

If the indicator/warning lamps do not light up in the instrument cluster at low temperatures, it is very likely that the discharged battery has frozen. In this case you may neither jump-start the vehicle nor charge the battery. Let the battery thaw first. The service life of a thawed-out battery may be shorter. The starting characteristics can be impaired, particularly at low temperatures. Have the thawed-out battery checked at a qualified specialist workshop.

Do not start the vehicle using a rapid charging device. If your vehicle's battery is discharged, the engine can be jump-started from another vehicle or from a second battery using jumper cables. Observe the following points:

- The battery is not accessible in all vehicles. If the other vehicle's battery is not accessible, jump-start the vehicle using a second battery or a jump-starting device.
- You may only jump-start the vehicle when the engine and exhaust system are cold.
- Do not start the engine if the battery is frozen. Let the battery thaw first.
- Only jump-start from batteries with a 12 V voltage rating.
- Only use jumper cables that are not damaged and have a sufficient cross-section and insulated terminal clamps.
- Make sure that the two vehicles do not touch.

Make sure that:

- The jumper cables are not damaged.
 - Non-insulated parts of the terminal clamps do not come into contact with other metal parts while the jumper cables are connected to the battery
 - The jumper cables cannot come into contact with parts that can move when the engine is running, such as the V-belt pulley or the fan
- ▶ Secure the vehicle by applying the electric parking brake.
- ▶ Shift the transmission to position **P**.
- ▶ Turn the SmartKey to position **0** in the ignition lock and remove it.
- ▶ Switch off all electrical consumers, e.g. rear window defroster, lighting, etc.
- ▶ Open the hood.

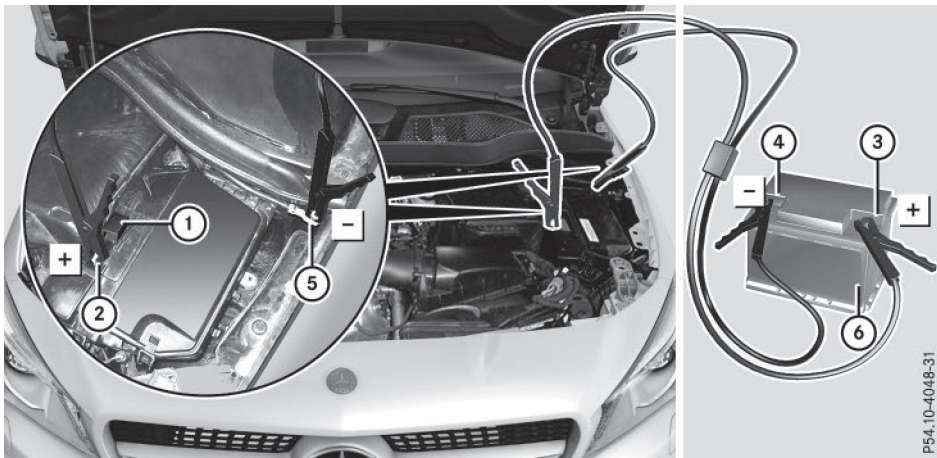

Position number ⑥ identifies the charged battery of the other vehicle or an equivalent jump-starting device.

- ▶ Press together cover ① of positive clamp ② and slide it back.
- ▶ Connect positive terminal ② on your vehicle to positive terminal ③ of donor battery ⑥ using the jumper cable, beginning with your own battery.
- ▶ Start the engine of the donor vehicle and run it at idling speed.
- ▶ Connect negative terminal ④ of donor battery ⑥ to ground point ⑤ of your vehicle using the jumper cable, connecting the jumper cable to battery of other vehicle ⑥ first.
- ▶ If the battery is fully discharged, leave the battery that is being used to jump-start connected for a few minutes before attempting to start. This charges the battery slightly.
- ▶ Start the engine.
- ▶ Before disconnecting the jumper cables, let the engine run for several minutes.
- ▶ First, remove the jumper cables from ground point ⑤ and negative terminal ④, then from positive clamp ② and positive terminal ③. Begin each time at the contacts on your own vehicle first.
- ▶ Close cover ① of positive terminal ② after removing the jumper cables.
- ▶ Close the hood.
- ▶ Have the battery checked at a qualified specialist workshop.

i Jump-starting is not considered to be a normal operating condition.

i Jumper cables and further information regarding jump-starting can be obtained at any qualified specialist workshop.

Towing and tow-starting

Important safety notes

WARNING

Functions relevant to safety are restricted or no longer available if:

- the engine is not running.
- the brake system or the power steering is malfunctioning.
- there is a malfunction in the voltage supply or the vehicle's electrical system.

If your vehicle is being towed, much more force may be necessary to steer or brake. There is a risk of an accident.

In such cases, use a tow bar. Before towing, make sure that the steering moves freely.

WARNING

You can no longer steer the vehicle if the steering wheel lock has been engaged. There is a risk of an accident.

Always switch off the ignition when towing the vehicle with a tow cable or a tow bar.

WARNING

When towing or tow-starting another vehicle and its weight is greater than the permissible gross weight of your vehicle, the:

- the towing eye could detach itself
- the vehicle/trailer combination could roll-over.

There is a risk of an accident.

When towing or tow-starting another vehicle, its weight should not be greater than the permissible gross weight of your vehicle.

Details on the permissible gross vehicle weight of your vehicle can be found on the vehicle identification plate (▷ page 308).

! When Active Brake Assist, Distance Pilot DISTRONIC or the HOLD function is activated,

the vehicle brakes automatically in certain situations.

To avoid damage to the vehicle, deactivate these systems in the following or similar situations:

- when towing the vehicle
- in the car wash

! Make sure that the electric parking brake is released. If the electric parking brake is faulty, visit a qualified specialist workshop.

! Only secure the tow rope or tow bar at the towing eyes. Otherwise, the vehicle could be damaged.

! Do not use the towing eyes for recovery purposes as this could damage the vehicle. If in doubt, recover the vehicle with a crane.

! When towing, pull away slowly and smoothly. If the tractive power is too high, the vehicles could be damaged.

! The vehicle can be towed a maximum of 30 miles (50km). The towing speed of 30 mph (50km/h) must not be exceeded.

If the vehicle has to be towed more than 30 miles (50km), the front axle must be raised or the entire vehicle raised and transported.

! Do not tow with sling-type equipment. This could damage the vehicle.

! When towing vehicles with KEYLESS-GO, use the key instead of the Start/Stop button. Otherwise, the automatic transmission may shift to position **P** when the driver's or front-passenger door are opened, which could lead to damage to the transmission.

! Vehicles with automatic transmission must not be started by tow-starting. This could otherwise damage the transmission.

It is better to have the vehicle transported than to have it towed away.

If the vehicle can no longer be driven because of an accident or breakdown, you have the following options:

- transporting the vehicle

As a rule, you should have the vehicle transported.

- towing the vehicle with a tow rope or tow bar
Only tow the vehicle in exceptional cases. The battery must be connected and charged. Otherwise, you:

- cannot turn the SmartKey to position **2** in the ignition lock
- cannot release the electric parking brake
- cannot move the transmission to position **N**

The function of the electric parking brake and the parking lock is dependent on the on-board voltage.

If the on-board voltage is low or if there is a system malfunction:

- the electric parking brake may not be applied in certain circumstances, or
- the transmission may not be shifted to **P**

Switch off non-essential consumers, e.g. the radio.

Disarm the automatic locking feature before the vehicle is towed (▷ page 184). You could otherwise be locked out when pushing or towing the vehicle.

Installing/removing the towing eye

Installing the towing eye

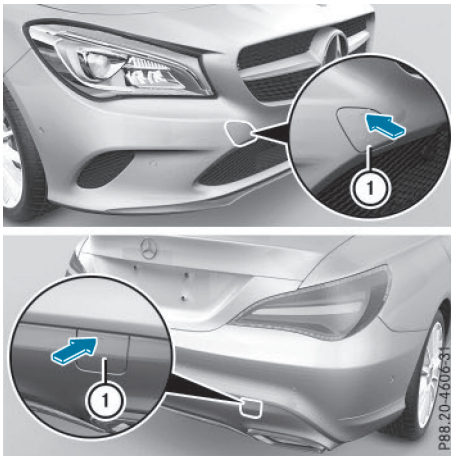

The brackets for the screw-in towing eye are located in the bumpers. They are at the rear and at the front, under covers ①.

- ▶ Remove the towing eye from the stowage space.

The towing eye is located with the vehicle tool kit under the cargo compartment floor (▷ page 266).

Vehicles with the TIREFIT kit: the towing eye is beneath the tire inflation compressor.

- ▶ Press the mark on cover ① inwards in the direction of the arrow.
- ▶ Take cover ① off the opening.
- ▶ Screw in the towing eye clockwise to the stop.

Removing the towing eye

- ▶ Unscrew and remove the towing eye.
- ▶ Attach cover ① to the bumper and press until it engages.
- ▶ Place the towing eye in the stowage well beneath the cargo compartment floor in the cargo compartment (▷ page 266).
- ▶ Vehicles with the TIREFIT kit: put back the tire inflation compressor.

Towing the vehicle with the front axle raised

Observe the important safety notes when towing your vehicle with the front axle raised (▷ page 276).

Only vehicles without 4MATIC can be towed with the front axle raised.

- ❗ Vehicles with 4MATIC must not be towed with either the front or the rear axle raised, as doing so will damage the transmission.

Vehicles with 4MATIC may either be towed away with both axles on the ground or be loaded up and transported.

- ❗ The ignition must be switched off if the vehicle is being towed with the front axle raised. Otherwise, ESP® may intervene and damage the brake system.

- ▶ **On vehicles with KEYLESS-GO or the KEYLESS-GO start function:** you must use the SmartKey instead of the Start/Stop button (▷ page 122).
- ▶ Make sure that the vehicle is stationary.
- ▶ Turn the SmartKey to position **2** in the ignition lock.

- ▶ When the vehicle is stationary, depress the brake pedal and keep it depressed.
- ▶ Shift the automatic transmission to position **P**.
- ▶ Release the brake pedal.
- ▶ Release the electric parking brake.
- ▶ Switch off the automatic locking (> page 184).
- ▶ Switch on the hazard warning lamps (> page 101).
- ▶ Turn the SmartKey in the ignition lock to position **0** and leave the SmartKey in the ignition lock.

Towing a vehicle with both axles on the ground

It is important that you observe the safety instructions when towing away your vehicle (> page 276).

- ▶ **On vehicles with KEYLESS-GO or the KEYLESS-GO start function:** you must use the SmartKey instead of the Start/Stop button (> page 122).

The automatic transmission automatically shifts to position **P** when you open the driver's or front-passenger door or when you remove the SmartKey from the ignition lock. In order to ensure that the automatic transmission stays in position **N** when towing the vehicle, you must observe the following points:

- ▶ Make sure that the vehicle is stationary.
- ▶ Turn the SmartKey to position **2** in the ignition lock.
- ▶ Depress and hold the brake pedal.
- ▶ Shift the automatic transmission to position **N**.
- ▶ Leave the SmartKey in position **2** in the ignition lock.
- ▶ Release the brake pedal.
- ▶ Release the electric parking brake.
- ▶ Switch on the hazard warning lamps (> page 101).

- i** In order to signal a change of direction when towing the vehicle with the hazard warning lamps switched on, use the combination switch as usual. In this case, only the indicator lamps for the direction of travel flash. After

resetting the combination switch, the hazard warning lamp starts flashing again.

Transporting the vehicle

4MATIC vehicles or vehicles with automatic transmission

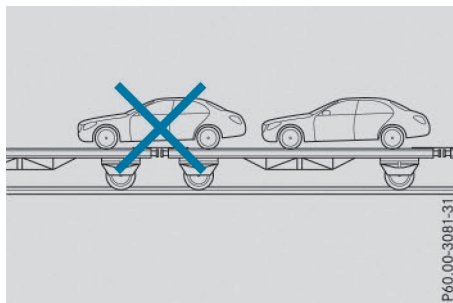

- !** When the vehicle is loaded for transport, the front and rear axles must be stationary and on the same transportation vehicle. Positioning over the connection point of the transport vehicle is not permitted. The drive train may otherwise be damaged.

All vehicles

- !** You may only secure the vehicle by the wheels, not by parts of the vehicle such as axle or steering components. Otherwise, the vehicle could be damaged.
- ▶ Turn the SmartKey to position **2** in the ignition lock (> page 121).
- ▶ Shift the transmission to position **N**.

As soon as the vehicle has been loaded:

- ▶ Prevent the vehicle from rolling away by applying the electric parking brake.
- ▶ Shift the transmission to position **P**.
- ▶ Turn the SmartKey to position **0** in the ignition lock and remove it.
- ▶ Secure the vehicle.

The towing eye can be used to pull the vehicle onto a trailer or transporter for transporting purposes.

Notes on 4MATIC vehicles

! Vehicles with 4MATIC must not be towed with either the front or the rear axle raised, as doing so will damage the transmission.

Vehicles with 4MATIC may only either be towed away with both axles on the ground or be loaded up and transported.

If the vehicle's transmission, front, or rear axle is damaged, have the vehicle transported on a truck or trailer.

In the event of damage to the electrical system:

If the battery is defective, the automatic transmission will be locked in position **P**. To shift the automatic transmission to position **N**, you must provide power to the vehicle's electrical system in the same way as when jump-starting (▷ page 273).

Have the vehicle transported on a transporter or trailer.

Tow-starting (emergency engine starting)

! Vehicles with automatic transmission must not be tow-started. You could otherwise damage the automatic transmission.

i You can find information on "Jump-starting" under (▷ page 273).

Fuses

Important safety notes

WARNING

If you manipulate or bridge a faulty fuse or if you replace it with a fuse with a higher amperage, the electric cables could be overloaded. This could result in a fire. There is a risk of an accident and injury.

Always replace faulty fuses with the specified new fuses having the correct amperage.

! Only use fuses that have been approved for Mercedes-Benz vehicles and which have the correct fuse rating for the system concerned. Only use fuses marked with an "S". Other-

wise, components or systems could be damaged.

! Make sure that no moisture can enter the fuse box when the cover is open.

! When closing the cover, make sure that it is lying correctly on the fuse box. Moisture seeping in or dirt could otherwise impair the operation of the fuses.

The fuses in your vehicle serve to close down faulty circuits. If a fuse blows, all the components on the circuit and their functions stop operating.

Blown fuses must be replaced with fuses of the same rating, which you can recognize by the color and value. The fuse ratings are listed in the fuse allocation chart.

The fuse allocation chart is in the fuse box in the front-passenger footwell (▷ page 280).

If a newly inserted fuse also blows, have the cause traced and rectified at a qualified specialist workshop, e.g. an authorized Mercedes-Benz Center.

Before changing a fuse

- ▶ Secure the vehicle against rolling away (▷ page 140).
- ▶ Switch off all electrical consumers.
- ▶ **Vehicles without KEYLESS-GO:** remove the SmartKey from the ignition lock.
- ▶ **Vehicles with KEYLESS-GO start-function or KEYLESS-GO:** open the driver's door. The vehicle electronics now have status **0**. This is the same as the SmartKey having been removed.

The fuses are located in various fuse boxes:

- Fuse box in the engine compartment on the left-hand side of the vehicle, when viewed in the direction of travel

- Fuse box in the front-passenger footwell

The fuse allocation chart is on the fuse box in the front-passenger footwell (▷ page 280).

Fuse box in the engine compartment

WARNING

When the hood is open and the windshield wipers are set in motion, you can be injured by the wiper linkage. There is a risk of injury. Always switch off the windshield wipers and the ignition before opening the hood.

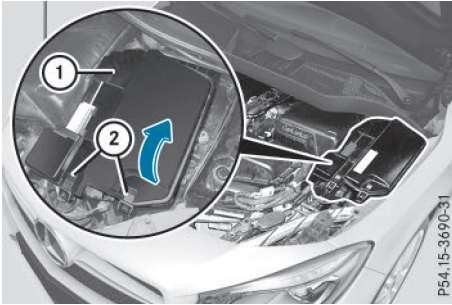

- ▶ Open the hood.
- ▶ Use a dry cloth to remove any moisture from the fuse box.
- ▶ **To open:** open clamps (2).
- ▶ Fold up cover (1) in the direction of the arrow and remove it.

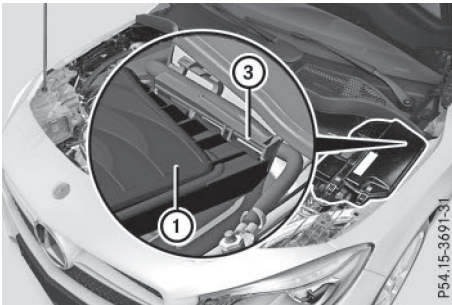

- ▶ **To close:** check whether the seal is lying correctly in cover (1).
- ▶ Insert cover (1) at the back into openings (3) on the fuse box.
- ▶ Fold down cover (1).

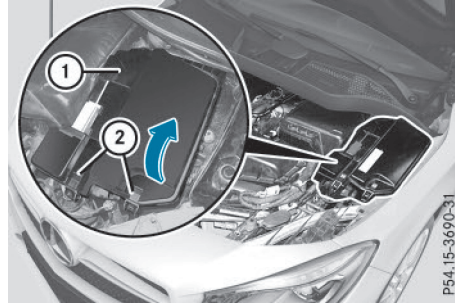

- ▶ Hook clamps (2) into the fuse box and close.
- ▶ Close the hood.

Fuse box in the front-passenger footwell



- ▶ **To open:** open the front-passenger door.
- ▶ Remove the floormat.
- ▶ Fold out perforated floor covering (1) in the direction of the arrow.

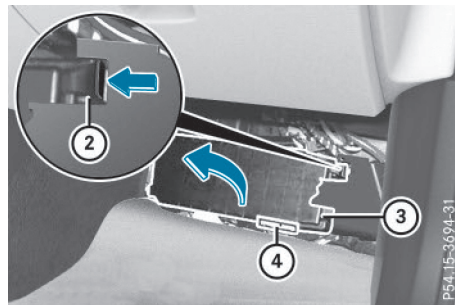

- ▶ To release cover (3), press retaining clamp (2).
- ▶ Fold out cover (3) in the direction of the arrow to the catch.

- ▶ Remove cover ③ forwards.
Fuse allocation chart ④ is located on the lower right-hand side of cover ③.
- ▶ **To close:** insert cover ③ on the left-hand side of the fuse box into the retainer.
Cover ③ engages in the retainers.
- ▶ Fold down cover ③ until clamps ② lock audibly.
- ▶ Fold back perforated floor covering ①.
- ▶ Install the floor mats.

Important safety notes

WARNING

If wheels and tires of the wrong size are used, the wheel brakes or suspension components may be damaged. There is a risk of an accident.

Always replace wheels and tires with those that fulfill the specifications of the original part.

When replacing wheels, make sure to use the correct:

- designation
- model

When replacing tires, make sure to use the correct:

- designation
- manufacturer
- model

WARNING

A flat tire severely impairs the driving, steering and braking characteristics of the vehicle. There is a risk of accident.

Tires without run-flat characteristics:

- do not drive with a flat tire.
- immediately replace the flat tire with your emergency spare wheel or spare wheel, or consult a qualified specialist workshop.

Tires with run-flat characteristics:

- pay attention to the information and warning notices on MOExtended tires (tires with run-flat characteristics).

Accessories that are not approved for your vehicle by Mercedes-Benz or are not being used correctly can impair the operating safety.

Before purchasing and using non-approved accessories, visit a qualified specialist workshop and inquire about:

- suitability
- legal stipulations
- factory recommendations

Further information regarding wheels and tires can be found under "Wheel/tire combinations" (▷ page 306).

You can ask for information regarding permitted wheel-tire combinations at an authorized Mercedes-Benz Center.

Information on tire pressure can be found:

- on the Tire and Loading Information placard on the B-pillar on the driver's side (▷ page 292)
- in the tire pressure table in the fuel filler flap (▷ page 138)
- under "Tire pressure" (▷ page 285)

Operation

Information on driving

Check the tire pressure when the vehicle is heavily laden and adjust prior to a trip.

While driving, pay attention to vibrations, noises and unusual handling characteristics, e.g. pulling to one side. This may indicate that the wheels or tires are damaged. If you suspect that a tire is defective, reduce your speed immediately. Stop the vehicle as soon as possible to check the wheels and tires for damage. Hidden tire damage could also be causing the unusual handling characteristics. If you find no signs of damage, have the tires and wheels checked at a qualified specialist workshop.

When parking your vehicle, make sure that the tires do not get deformed by the curb or other obstacles. If they cannot be avoided, drive over obstacles such as curbs slowly and at an obtuse angle. Otherwise, you may damage the wheels or tires.

Regular checking of wheels and tires

WARNING

Damaged tires can cause tire inflation pressure loss. As a result, you could lose control of your vehicle. There is a risk of accident.

Check the tires regularly for signs of damage and replace any damaged tires immediately.

Check wheels and tires for damage at least once a month. Check wheels and tires after driving off-road or on rough roads. Damaged wheels can cause a loss of tire pressure. Pay particular attention to damage such as:

- cuts in the tires
- punctures in the tires
- tears in the tires
- bulges on tires
- deformation or severe corrosion on wheels

Regularly check the tire tread depth and the condition of the tread across the whole width of the tire (▷ page 283). If necessary, turn the front wheels to full lock in order to inspect the inner side of the tire surface.

All wheels must have a valve cap to protect the valve against dirt and moisture. Do not mount anything onto the valve other than the standard valve cap or other valve caps approved by Mercedes-Benz for your vehicle. Do not use any other valve caps or systems, e.g. tire pressure monitoring systems.

Regularly check the pressure of all the tires particularly prior to long trips. Adjust the tire pressure as necessary (▷ page 285).

The service life of tires depends, among other things, on the following factors:

- Driving style
- Tire pressure
- Distance covered

Notes on tire tread

WARNING

Insufficient tire tread will reduce tire traction. The tire is no longer able to dissipate water. This means that on wet road surfaces, the risk of hydroplaning increases, in particular where speed is not adapted to suit the driving conditions. There is a risk of accident.

If the tire pressure is too high or too low, tires may exhibit different levels of wear at different locations on the tire tread. Thus, you should regularly check the tread depth and the condition of the tread across the entire width of all tires.

Minimum tire tread depth for:

- Summer tires: $\frac{1}{8}$ in (3 mm)
- M+S tires: $\frac{1}{8}$ in (4 mm)

For safety reasons, replace the tires before the legally prescribed limit for the minimum tire tread depth is reached.

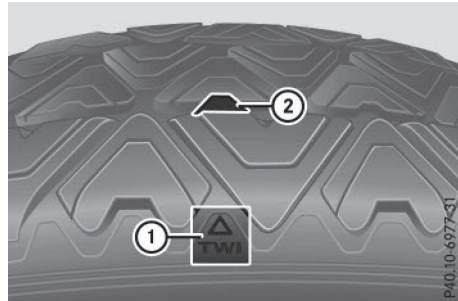

Marking ① shows where bar indicator ② for tread wear is integrated into the tire tread.

Treadwear indicators (TWI) are required by law. Six indicators are positioned on the tire tread. They are visible once a tread depth of approximately $\frac{1}{16}$ in (1.6 mm) has been reached. If this is the case, the tire is so worn that it must be replaced.

Selecting, mounting and replacing tires

WARNING

Exceeding the stated tire load-bearing capacity and the approved maximum speed could lead to tire damage or the tire bursting. There is a risk of accident.

Therefore, only use tire types and sizes approved for your vehicle model. Observe the tire load rating and speed rating required for your vehicle.

- Only mount tires and wheels of the same type and make.
Exception: it is permissible to install a different type or make in the event of a flat tire. Observe here the "MOExtended tires (tires

with run-flat characteristics)" section (> page 267).

- Only mount tires of the correct size onto the wheels.
- Break in new tires at moderate speeds for the first 60 miles (100 km). The new tires only reach their full performance after this distance.
- Do not drive with tires which have too little tread depth, as this significantly reduces the traction on wet roads (hydroplaning).
- Replace the tires after six years at the latest, regardless of wear.

MOExtended tires (tires with run-flat properties)

With MOExtended tires (tires with run flat characteristics), you can continue to drive your vehicle even if there is a total loss of pressure in one or more tires.

MOExtended tires may only be used in conjunction with an activated tire pressure loss warning system (Canada only) or tire pressure monitor (USA only) and only on wheels specifically tested by Mercedes-Benz.

Notes on driving with MOExtended tires with a flat tire (> page 267).

Vehicles equipped with MOExtended tires are not equipped with a TIREFIT kit at the factory. It is therefore recommended that you additionally equip your vehicle with a TIREFIT kit if you mount tires that do not feature run-flat properties, e.g. winter tires. A TIREFIT kit may be obtained from a qualified specialist workshop.

Winter operation

General notes

Have your vehicle winter-proofed at a qualified specialist workshop at the onset of winter.

Observe the notes in the "Changing a wheel" section (> page 301).

Driving with summer tires

At temperatures below 45 °F (+7 °C), summer tires lose elasticity and therefore traction and braking power. Change the tires on your vehicle to M+S tires. Using summer tires at very cold

temperatures could cause cracks to form, thereby damaging the tires permanently. Mercedes-Benz cannot accept responsibility for this type of damage.

WARNING

Damaged tires can cause tire inflation pressure loss. As a result, you could lose control of your vehicle. There is a risk of accident.

Check the tires regularly for signs of damage and replace any damaged tires immediately.

M+S tires

WARNING

M+S tires with a tire tread depth of less than $\frac{1}{8}$ in (4 mm) are not suitable for use in winter and do not provide sufficient traction. There is a risk of an accident.

M+S tires with a tread depth of less than $\frac{1}{8}$ in (4 mm) must be replaced immediately.

At temperatures below 45 °F (+7 °C), use winter tires or all-season tires. Both types of tire are identified by the M+S marking.

Only winter tires bearing the  snowflake symbol in addition to the M+S marking provide the best possible grip in wintry road conditions. Only these tires will allow driving safety systems such as ABS and ESP® to function optimally in winter. These tires have been developed specifically for driving in snow.

Use M+S tires of the same make and tread on all wheels to maintain safe handling characteristics.

Always observe the maximum permissible speed specified for the M+S tires you have mounted.

When you have mounted the M+S tires:

- ▶ Check the tire pressures (> page 285).
- ▶ Restart the tire pressure monitor (USA only) (> page 291).
- ▶ Restart the tire pressure loss warning system (Canada) (> page 289)

Snow chains

WARNING

If snow chains are mounted on the rear wheels, the snow chains could cause abrasion to the vehicle body or to chassis components. This could cause damage to the vehicle or the tires. There is a risk of an accident.

To avoid hazardous situations:

- never mount snow chains on the rear wheels
- only mount snow chains in pairs on the front wheels.

! On some tire sizes there is not enough space for snow chains. To avoid damage to the vehicle or tires, observe the "Wheel and tire combinations" section under "Tires and wheels".

For safety reasons, Mercedes-Benz recommends that you only use snow chains that have been specially approved for your vehicle by Mercedes-Benz, or are of a corresponding standard of quality. For more information, please contact a qualified specialist workshop. If you intend to mount snow chains, please bear the following points in mind:

- Snow chains may not be mounted on all wheel/tire combinations. Permissible wheel-tire combinations (▷ page 306).
- Only use snow chains when driving on roads completely covered by snow. Remove the snow chains as soon as possible when you come to a road that is not snow-covered.
- Local regulations may restrict the use of snow chains. Observe the appropriate regulations if you wish to mount snow chains.
- Do not exceed the maximum permissible speed of 30 mph (50 km/h).
- Do not use Parking Pilot when snow chains are installed (▷ page 162).

You may wish to deactivate ESP® (▷ page 63) when pulling away with snow chains installed. You can thereby allow the wheels to spin in a controlled manner, achieving an increased driving force (cutting action).

Tire pressure

Tire pressure specifications

Important safety notes

WARNING

Underinflated or overinflated tires pose the following risks:

- the tires may burst, especially as the load and vehicle speed increase.
- the tires may wear excessively and/or unevenly, which may greatly impair tire traction.
- the driving characteristics, as well as steering and braking, may be greatly impaired.

There is a risk of an accident.

Follow recommended tire inflation pressures and check the pressure of all the tires including the spare wheel:

- monthly, at least
- if the load changes
- before beginning a long journey
- under different operating conditions, e.g. off-road driving

If necessary, correct the tire pressure.

i The data on the Tire and Loading Information placard and tire pressure table shown here are examples. Tire pressure specifications are vehicle-specific and may deviate from the data shown here. The tire pressure specifications that are valid for your vehicle can be found on the Tire and Loading Information placard and tire pressure table on the vehicle.

General notes

The recommended tire pressures for the tires mounted at the factory can be found on the labels described here.

Further information on tire pressures can be obtained at a qualified specialist workshop.

Tire and Loading Information placard

TIRE RENSEIGNEMENTS SUR LES PNEUS ET LE CHARGEMENT

SEATING CAPACITY / NOMBRE DE PLACES: 7
 The combined weight of occupants and cargo should never exceed 7000 lbs. (3150 kg) or the vehicle's gross vehicle weight rating (GVWR).

TIRE PNEU	SIZE DIMENSIONS	COLD TIRE PRESSURE PRESSION DES PNEUS À FROID
FRONT AVANT	255/40 ZR18 99V XL	200 kPa, 29 PSI
REAR ARRIÈRE	285/35 ZR18 101Y XL	200 kPa, 29 PSI
SPARE DE SECOURS	175/55-18 95P	420 kPa, 60 PSI

SEE OWNER'S MANUAL FOR ADDITIONAL INFORMATION. VOIR LE MANUEL DE L'USAGER POUR PLUS DE RENSEIGNEMENTS.

P40.00-2223-31

① Recommended tire pressures

The Tire and Loading Information placard is on the B-pillar on the driver's side (▷ page 292). The Tire and Loading Information placard contains the recommended tire pressures for cold tires. The recommended tire pressures are valid for the maximum permissible load and up to the maximum permissible vehicle speed.

Tire pressure table

The tire pressure table is on the inside of the fuel filler flap. It shows the tire pressure for all tires permitted at the factory for this vehicle; see illustration (example).

COLD TIRE PRESSURE

LOAD CONDITION	FRONT	REAR
normal load	200 kPa / 29 PSI	200 kPa / 29 PSI
maximum load	200 kPa / 29 PSI	200 kPa / 29 PSI

Warm tires up to: + 4 psi

P40.00-2229-31

The tire pressure table contains the recommended pressures for cold tires for various operating conditions, i.e. differing load and speed conditions.

If a tire size precedes a tire pressure, the following tire pressure information is only valid for that tire size; see illustration (example).

LUFTDRUCK PRESSURE PRESSION PRESSION

für kalte Reifen / for cold tires / des pneus froids / de inflado

100 kPa = 1 bar

Tire Size	Normal Load	Maximum Load	Warm Tires
195/55 R16	200 kPa / 29 PSI	200 kPa / 29 PSI	+ 30 kPa / + 4 PSI
215/45 R17	200 kPa / 29 PSI	200 kPa / 29 PSI	+ 30 kPa / + 4 PSI
215/40 R18	200 kPa / 29 PSI	200 kPa / 29 PSI	+ 30 kPa / + 4 PSI

Warme Reifen / Warm tires up to: + 30 kPa / + 4 PSI. Pneus chauffés jusqu'à: Neumáticos calientes hasta: + 30 kPa / + 4 PSI.

P40.00-2228-31

The load conditions "partially laden" and "fully laden" are defined in the table for different numbers of occupants and amounts of luggage. The actual number of seats may differ.

Lufdruck für kalte Reifen
Tire pressure cold tires / Pression des pneus froids / Presión de inflado

100 kPa = 1 bar

Rim Diameter	Normal Load	Maximum Load	Warm Tires
R18	200 kPa / 29 PSI	200 kPa / 29 PSI	+ 30 kPa / + 4 PSI
R19	200 kPa / 29 PSI	200 kPa / 29 PSI	+ 30 kPa / + 4 PSI

Warme Reifen bis: Warm tires up to: + 30 kPa / + 4 PSI. Pneus chauffés jusqu'à: Neumáticos calientes hasta: + 30 kPa / + 4 PSI.

P40.00-2230-31

Some tire pressure tables show only the rim diameters instead of the full tire size, e.g. **R18**. Rim diameter is part of the tire size and can be found on the tire sidewall (▷ page 296).

If the tire pressures have been set to the lower values for lighter loads and/or lower road speeds, the pressures should be reset to the higher values:

- if you want to drive with an increased load and/or
- if you want to drive at higher speeds

i The tire pressures for increased loads and/or higher road speeds, shown in the tire pressure table, may have a negative effect on driving comfort.

If the tire pressure is not set correctly, this can lead to an excessive build up of heat and a sudden loss of pressure.

For more information, contact a qualified specialist workshop.

Important notes on tire pressure

WARNING

If the tire pressure drops repeatedly, the wheel, valve or tire may be damaged. Tire pressure that is too low may result in a tire blow-out. There is a risk of an accident.

- Check the tire for foreign objects.
- Check whether the wheel is losing air or the valve is leaking.

If you are unable to rectify the damage, contact a qualified specialist workshop.

WARNING

If you fit unsuitable accessories onto tire valves, the tire valves may be overloaded and malfunction, which can cause tire pressure loss. Due to their design, retrofitted tire pressure monitors keep the tire valve open. This can also result in tire pressure loss. There is a risk of an accident.

Only screw the standard valve cap or other valve caps approved by Mercedes-Benz for your vehicle onto the tire valve.

Use a suitable pressure gauge to check the tire pressure. The outer appearance of a tire does not permit any reliable conclusion about the tire pressure. On vehicles equipped with the electronic tire pressure monitor, the tire pressure can be checked in the on-board computer.

The tire temperature and pressure increase when the vehicle is in motion. This is dependent on the driving speed and the load.

Therefore, you should only correct tire pressures when the tires are cold.

The tires are cold:

- if the vehicle has been parked with the tires out of direct sunlight for at least three hours and
- if the vehicle has been driven less than 1 mile (1.6 km)

The tire temperature changes depending on the outside temperature, the vehicle speed and the tire load. If the tire temperature changes by 18 °F (10 °C), the tire pressure changes by approximately 10 kPa (0.1 bar / 1.5 psi). Take this into account when checking the pressure of warm tires. Only correct the tire pressure if it is

too low for the current operating conditions. If you check the tire pressure when the tires are warm, the resulting value will be higher than if the tires were cold. This is normal. Do not reduce the tire pressure to the value specified for cold tires. The tire pressure would otherwise be too low.

Observe the recommended tire pressures for cold tires:

- on the Tire and Loading Information placard on the B-pillar on the driver's side
- in the tire pressure table in the fuel filler flap (> page 138)

Underinflated or overinflated tires

Underinflated tires

WARNING

Tires with pressure that is too low can overheat and burst as a consequence. In addition, they also suffer from excessive and/or irregular wear, which can severely impair the braking properties and the driving characteristics. There is a risk of an accident.

Avoid tire pressures that are too low in all the tires, including the spare wheel.

Underinflated tires may:

- overheat, leading to tire defects
- adversely affect handling
- wear excessively and/or unevenly
- have an adverse effect on fuel consumption

Overinflated tires

WARNING

Tires with excessively high pressure can burst because they are damaged more easily by road debris, potholes etc. In addition, they also suffer from irregular wear, which can severely impair the braking properties and the driving characteristics. There is a risk of an accident.

Avoid tire pressures that are too high in all the tires, including the spare wheel.

Overinflated tires may:

- increase the braking distance
- adversely affect handling
- wear excessively and/or unevenly
- have an adverse effect on ride comfort
- be more susceptible to damage

Maximum tire pressures



- ① Example: maximum permissible tire pressure

Never exceed the maximum permissible tire inflation pressure. Always observe the recommended tire pressure for your vehicle when adjusting the tire pressure (▷ page 285).

- i** The actual values for tires are vehicle-specific and may deviate from the values in the illustration.

Checking the tire pressures

Important safety notes

Observe the notes on tire pressure (▷ page 285).

Information on air pressure for the tires on your vehicle can be found:

- on the vehicle's Tire and Loading Information placard on the B-pillar
- in the tire pressure table in the fuel filler flap (▷ page 138)
- in the "Tire pressure" section

Checking tire pressures manually

To determine and set the correct tire pressure, proceed as follows:

- ▶ Remove the valve cap of the tire that is to be checked.
- ▶ Press the tire pressure gauge securely onto the valve.
- ▶ Read the tire pressure and compare it to the recommended value on the Tire and Loading Information placard or the tire pressure table (▷ page 285).
- ▶ If the tire pressure is too low, increase the tire pressure to the recommended value.
- ▶ If the tire pressure is too high, release air. To do so, press down the metal pin in the valve, using the tip of a pen for example. Then check the tire pressure again using the tire pressure checker.
- ▶ Screw the valve cap onto the valve.
- ▶ Repeat these steps for the other tires.

Tire pressure loss warning system (Canada only)

General notes

While the vehicle is in motion, the tire pressure loss warning system monitors the set tire pressure using the rotational speed of the wheels. This enables the system to detect significant pressure loss in a tire. If the speed of rotation of a wheel changes as a result of a loss of pressure, a corresponding warning message will appear in the multifunction display.

You can recognize the tire pressure loss warning by the **Run Flat Indicator Active Press 'OK' to Restart** message in the multifunction display in the **Serv.** menu. Information on the message display can be found in the "Restarting the tire pressure loss warning system" section (▷ page 289).

Important safety notes

The tire pressure warning system does not warn you of an incorrectly set tire pressure. Observe the notes on the recommended tire pressure (▷ page 285).

The tire pressure loss warning does not replace the need to regularly check the tire pressure. An even loss of pressure on several tires at the

same time cannot be detected by the tire pressure loss warning system.





The tire pressure monitor is not able to warn you of a sudden loss of pressure, e.g. if the tire is penetrated by a foreign object. In the event of a sudden loss of pressure, bring the vehicle to a halt by braking carefully. Avoid abrupt steering movements.

The function of the tire pressure loss warning system is limited or delayed if:





- snow chains are mounted on your vehicle's tires.
- road conditions are wintry.
- you are driving on sand or gravel.
- you adopt a very sporty driving style (cornering at high speeds or driving with high rates of acceleration).
- you are driving with a heavy load (in the vehicle or on the roof)

Restarting the tire pressure loss warning system





Restart the tire pressure loss warning system if you have:

- changed the tire pressure
- changed the wheels or tires
- mounted new wheels or tires
- ▶ Before restarting, make sure that the tire pressures are set properly on all four tires for the respective operating conditions.
The recommended tire pressure can be found on the Tire and Loading Information placard on the B-pillar. Additionally, a tire pressure table is attached to the fuel filler flap. The tire pressure loss warning system can only give reliable warnings if you have set the correct tire pressure. If an incorrect tire pressure is set, these incorrect values will be monitored.
- ▶ Also observe the notes in the section on tire pressures (▷ page 285).
- ▶ Make sure that the SmartKey is in position 2 in the ignition lock (▷ page 121).
- ▶ Press  or  on the steering wheel to select the **Serv.** menu.
- ▶ Press the  or  button to select **Tire Pressure**.
- ▶ Press the  button.
The **Run Flat Indicator Active Press 'OK' to Restart** message appears in the multifunction display.

If you wish to confirm the restart:

- ▶ Press the  button.
The **Tire Pressure Now OK?** message appears in the multifunction display.
- ▶ Press the  or  button to select **Yes**.
- ▶ Press the  button.
The **Run Flat Indicator Restarted** message appears in the multifunction display.
After a teach-in period, the tire pressure loss warning system will monitor the set tire pressures of all four tires.

If you wish to cancel the restart:

- ▶ Press the  button.
or
- ▶ If the **Tire Pressure Now OK?** message appears, press the  or  button to select **Cancel**.
- ▶ Press the  button.
The tire pressure values stored at the last restart will continue to be monitored.

Tire pressure monitor

General notes

If a tire pressure monitor is installed, the vehicle's wheels have sensors that monitor the tire pressures in all four tires. The tire pressure monitor warns you if the pressure drops in one or more of the tires. The tire pressure monitor only functions if the corresponding sensors are installed in all wheels.

Information on tire pressures is displayed in the multifunction display. After a few minutes of driving, the current tire pressure of each tire is shown in the **Serv.** menu of the multifunction display, see illustration (example).



For information on the message display, refer to the "Checking the tire pressure electronically" section (▷ page 291).

Important safety notes**⚠ WARNING**

Each tire, including the spare (if provided), should be checked at least once every two weeks when cold and inflated to the pressure recommended by the vehicle manufacturer on the Tire and Loading Information placard on the driver's door B-pillar or the tire pressure label on the inside of the fuel filler flap. If your vehicle has tires of a different size than the size indicated on the Tire and Loading Information placard or, if available, the tire pressure label, you should determine the proper tire pressure for those tires.

As an added safety feature, your vehicle has been equipped with a tire pressure monitoring system (TPMS) that illuminates a low tire pressure telltale when one or more of your tires are significantly underinflated. Accordingly, when the low tire pressure telltale lights up, you should stop and check your tires as soon as possible, and inflate them to the proper pressure. Driving on a significantly underinflated tire causes the tire to overheat and can lead to tire failure.

Underinflation also reduces fuel efficiency and tire tread life, and may affect the vehicle's handling and stopping ability. Please note that the TPMS is not a substitute for proper tire maintenance, and it is the driver's responsibility to maintain correct tire pressure, even if underinflation has not reached the level to trigger illumination of the TPMS low tire pressure telltale.

Your vehicle has also been equipped with a TPMS malfunction indicator to indicate when the system is not operating properly. The TPMS malfunction indicator is combined with the low tire pressure telltale. When the system detects a malfunction, the warning lamp will flash for approximately a minute and then remain continuously illuminated. This sequence will be repeated every time the vehicle is started as long as the malfunction exists. When the malfunction indicator is illu-

minated, the system may not be able to detect or signal low tire pressure as intended.

TPMS malfunctions may occur for a variety of reasons, including the installation of incompatible replacement or alternate tires or wheels on the vehicle that prevent the TPMS from functioning properly. Always check the TPMS malfunction telltale after replacing one or more tires or wheels on your vehicle to ensure that the replacement or alternate Tires and wheels allow the TPMS to continue to function properly.

It is the driver's responsibility to set the tire pressure to that recommended for cold tires which is suitable for the operating situation (> page 285). Note that the correct tire pressure for the current operating situation must first be taught-in to the tire pressure monitor. If a substantial loss of pressure occurs, the warning threshold for the warning message is aligned to the taught-in reference values. Restart the tire pressure monitor after adjusting the pressure of the cold tires (> page 291). The current pressures are saved as new reference values. As a result, a warning message will appear if the tire pressure drops significantly.

The tire pressure monitor does not warn you of an incorrectly set tire pressure. Observe the notes on the recommended tire pressure (> page 285).

The tire pressure monitor is not able to warn you of a sudden loss of pressure, e.g. if the tire is penetrated by a foreign object. In the event of a sudden loss of pressure, bring the vehicle to a halt by braking carefully. Avoid abrupt steering movements.

The tire pressure monitor has a yellow warning lamp in the instrument cluster for indicating pressure loss or a malfunction. Whether the warning lamp flashes or lights up indicates whether a tire pressure is too low or the tire pressure monitor is malfunctioning:

- if the warning lamp is lit continuously, the tire pressure on one or more tires is significantly too low. The tire pressure monitor is not malfunctioning.
- if the warning lamp flashes for around a minute and then remains lit constantly, the tire pressure monitor is malfunctioning.

In addition to the warning lamp, a message appears in the multifunction display. Observe





the information on display messages (> page 209).

It may take up to ten minutes for a malfunction of the tire pressure monitor to be indicated. A malfunction will be indicated by the tire pressure warning lamp flashing for approximately one minute and then remaining lit. When the malfunction has been rectified, the tire pressure warning lamp goes out after a few minutes of driving.

The tire pressure values indicated by the on-board computer may differ from those measured at a gas station with a pressure gauge. The tire pressures shown by the on-board computer refer to those measured at sea level. At high altitudes, the tire pressure values indicated by a pressure gauge are higher than those shown by the on-board computer. In this case, do not reduce the tire pressures.

The operation of the tire pressure monitor can be affected by interference from radio transmitting equipment (e.g. radio headphones, two-way radios) that may be being operated in or near the vehicle.

Checking the tire pressure electronically

- ▶ Make sure that the SmartKey is in position 2 in the ignition lock (> page 121).
- ▶ Press  or  on the steering wheel to select the **Serv.** menu.
- ▶ Press the  or  button to select **Tire Pressure**.
- ▶ Press the  button.
The current tire pressure of each tire is shown in the multifunction display.

If the vehicle was parked for longer than 20 minutes, the **Tire pressure will be displayed after driving a few minutes** message is shown.

After a teach-in process, the tire pressure monitor automatically detects new wheels or new sensors. As long as a clear allocation of the tire pressure value to the individual wheels is not possible, the **Tire Pressure Monitor Active** message is shown instead of the tire pressure display. The tire pressures are already being monitored.

Tire pressure monitor warning messages

If the tire pressure monitor detects a pressure loss in one or more tires, a warning message is shown in the multifunction display. The yellow tire pressure warning lamp then lights up.

- If the **Please Correct Tire Pressure** message appears in the multifunction display, the tire pressure in at least one tire is too low. The tire pressure must be corrected when the opportunity arises.
- If the **Check Tire Pressure** message appears in the multifunction display, the tire pressure in one or more tires has dropped significantly. The tires must be checked.
- If the **Tire Pressure Warning Tire Failure** message appears, the tire pressure in one or more tires has dropped suddenly. The tires must be checked.

Observe the instructions and safety notes in the display messages in the "Tires" section (> page 209).

If the wheel positions on the vehicle are rotated, the tire pressures may be displayed for the wrong positions for a short time. This is rectified after a few minutes of driving, and the tire pressures are displayed for the correct positions.

Restarting the tire pressure monitor

When you restart the tire pressure monitor, all existing warning messages are deleted and the warning lamps go out. The monitor uses the currently set tire pressures as the reference values for monitoring. In most cases, the tire pressure monitor will automatically detect the new reference values after you have changed the tire pressure. However, you can also set reference values manually as described here. The tire pressure monitor then monitors the new tire pressure values.

- ▶ Set the tire pressure to the value recommended for the corresponding driving situation on the Tire and Loading Information placard on the driver's side B-pillar (> page 285).
You can find more tire pressure values for various operating conditions in the tire pressure table inside the fuel filler flap (> page 138).
- ▶ Make sure that the tire pressure is correct on all four wheels.

- ▶ Make sure that the SmartKey is in position 2 in the ignition lock (▷ page 121).
- ▶ Press or on the steering wheel to select the **Serv.** menu.
- ▶ Press the or button to select **Tire Pressure**.
- ▶ Press the button.
The multifunction display shows the current tire pressure for each tire or the **Tire pressure will be displayed after driving a few minutes** message.
- ▶ Press the button.
The multifunction display shows the **Use Current Pressures as New Reference Values** message.

If you wish to confirm the restart:

- ▶ Press the button.
The **Tire Press. Monitor Restarted** message appears in the multifunction display.
After driving for a few minutes, the system checks whether the current tire pressures are within the specified range. The new tire pressures are then accepted as reference values and monitored.

If you wish to cancel the restart:

- ▶ Press the button.
The tire pressure values stored at the last restart will continue to be monitored.

Radio type approval for the tire pressure monitor

Country	Radio type approval number
USA	FCC ID: MRXMW2433A FCC ID: MRXGG4 FCC ID: MRXMC34MA4
Canada	IC: 2546A-MW2433A IC: 2546A-GG4 IC: 2546A-MC34MA4

Loading the vehicle

Instruction labels for tires and loads

WARNING

Overloaded tires can overheat, causing a blowout. Overloaded tires can also impair the

steering and driving characteristics and lead to brake failure. There is a risk of accident.

Observe the load rating of the tires. The load rating must be at least half of the GAWR of your vehicle. Never overload the tires by exceeding the maximum load.

Two instruction labels on your vehicle show the maximum possible load.

- (1) The Tire and Loading Information placard is on the B-pillar on the driver's side. The Tire and Loading Information placard shows the maximum permissible number of occupants and the maximum permissible vehicle load. It also contains details of the tire sizes and corresponding pressures for tires mounted at the factory.
- (2) The vehicle identification plate is on the B-pillar on the driver's side. The vehicle identification plate informs you of the gross vehicle weight rating. It is made up of the vehicle weight, all vehicle occupants, the fuel and the cargo. You can also find information about the maximum gross axle weight rating on the front and rear axle.

The maximum gross axle weight rating is the maximum weight that can be carried by one axle (front or rear axle). Never exceed the maximum load or the maximum gross axle weight rating for the front or rear axle.

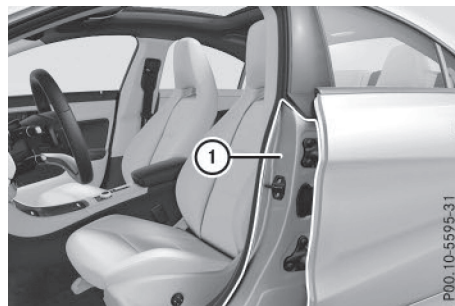

① B-pillar, driver's side

Maximum permissible gross vehicle weight rating

TIRE LOADING INFORMATION
RENSEIGNEMENTS SUR LES PNEUS ET LE CHARGEMENT

SEATING CAPACITY / NOMBRE DE PLACES: TOTAL 7 | FRONT AVANT 2 | MIDDLE MILIEU 3 | REAR ARRIERE 2

The combined weight of occupants and cargo should never exceed XXX kg or XXX lbs.
Le poids total des occupants et du chargement ne doit jamais dépasser XXX kg ou XXX lb.*

TIRE PNEU	SIZE DIMENSIONS	COLD TIRE PRESSURE / PRESSION DES PNEUS A FROID	SEE OWNER'S MANUAL FOR ADDITIONAL INFORMATION / VOIR LE MANUEL DE L'USAGER POUR PLUS DE RENSEIGNEMENTS
FRONT AVANT	255/40 ZR18 99Y XL	200 KPA, 29 PSI	
REAR ARRIERE	285/35 ZR18 101Y XL	200 KPA, 29 PSI	
SPARE DE SECOURS	175/55-18 95P	420 KPA, 60 PSI	

P40.00-2224-31

- Specification for maximum gross vehicle weight (1) is listed in the Tire and Loading Information placard: "The combined weight of occupants and cargo should never exceed XXX kilograms or XXX lbs."

The gross weight of all vehicle occupants, load and luggage must not exceed the specified value.

- i The specifications shown on the Tire and Loading Information placard in the illustration are examples. The maximum permissible gross vehicle weight rating is vehicle-specific and may differ from that in the illustration. You can find the valid maximum permissible gross vehicle weight rating for your vehicle on the Tire and Loading Information placard.

Number of seats

TIRE LOADING INFORMATION
RENSEIGNEMENTS SUR LES PNEUS ET LE CHARGEMENT

SEATING CAPACITY / NOMBRE DE PLACES: TOTAL 7 | FRONT AVANT 2 | MIDDLE MILIEU 3 | REAR ARRIERE 2

The combined weight of occupants and cargo should never exceed XXX kg or XXX lbs.
Le poids total des occupants et du chargement ne doit jamais dépasser XXX kg ou XXX lb.*

TIRE PNEU	SIZE DIMENSIONS	COLD TIRE PRESSURE / PRESSION DES PNEUS A FROID	SEE OWNER'S MANUAL FOR ADDITIONAL INFORMATION / VOIR LE MANUEL DE L'USAGER POUR PLUS DE RENSEIGNEMENTS
FRONT AVANT	255/40 ZR18 99Y XL	200 KPA, 29 PSI	
REAR ARRIERE	285/35 ZR18 101Y XL	200 KPA, 29 PSI	
SPARE DE SECOURS	175/55-18 95P	420 KPA, 60 PSI	

P40.00-2225-31

Example: steps 1 to 3

The following table shows examples on how to calculate total and cargo load capacities with varying seating configurations and number and size of occupants. The following examples use a load limit of

Maximum number of seats (1) indicates the maximum number of occupants allowed to travel in the vehicle. This information can be found on the Tire and Loading Information placard.

- i The specifications shown on the Tire and Loading Information placard in the illustration are examples. The number of seats is vehicle-specific and can differ from the details shown. The number of seats in your vehicle can be found on the Tire and Loading Information placard.

Determining the correct load limit

Step-by-step instructions

The following steps have been developed as required of all manufacturers under Title 49, Code of U.S. Federal Regulations, Part 575 pursuant to the "National Traffic and Motor Vehicle Safety Act of 1966".

- **Step 1:** Locate the statement "The combined weight of occupants and cargo should never exceed XXX kg or XXX lbs." on your vehicle's Tire and Loading Information placard.
- **Step 2:** Determine the combined weight of the driver and passengers that will be riding in your vehicle.
- **Step 3:** Subtract the combined weight of the driver and passengers from XXX kilograms or XXX lbs.
- **Step 4:** The resulting figure equals the available amount of cargo and luggage load capacity. For example, if the "XXX" amount equals 1400 lbs and there will be five 150-lb passengers in your vehicle, the amount of available cargo and luggage load capacity is 650 lbs (1400 - 750 (5 x 150) = 650 lbs).
- **Step 5:** Determine the combined weight of luggage and cargo being loaded on the vehicle. That weight may not safely exceed the available cargo and luggage load capacity calculated in step 4.

1500 lbs (680 kg). **This is for illustration purposes only.** Make sure you are using the actual load limit for your vehicle stated on your vehicle's Tire and Loading Information placard (▷ page 292). The greater the combined weight of the occupants, the lower the maximum luggage load.

Step 1

	Example 1	Example 2	Example 3
Combined maximum weight of occupants and cargo (data from the Tire and Loading Information placard)	1500 lbs (680 kg)	1500 lbs (680 kg)	1500 lbs (680 kg)

Step 2

	Example 1	Example 2	Example 3
Number of people in the vehicle (driver and occupants)	5	3	1
Distribution of the occupants	Front: 2 Rear: 3	Front: 1 Rear: 2	Front: 1
Weight of the occupants	Occupant 1: 150 lbs (68 kg) Occupant 2: 180 lbs (82 kg) Occupant 3: 160 lbs (73 kg) Occupant 4: 140 lbs (63 kg) Occupant 5: 120 lbs (54 kg)	Occupant 1: 200 lbs (91 kg) Occupant 2: 190 lbs (86 kg) Occupant 3: 150 lbs (68 kg)	Occupant 1: 150 lbs (68 kg)
Gross weight of all occupants	750 lbs (340 kg)	540 lbs (245 kg)	150 lbs (68 kg)

Step 3

	Example 1	Example 2	Example 3
Permissible load (maximum gross vehicle weight rating from the Tire and Loading Information placard minus the gross weight of all occupants)	1500 lbs (680 kg) - 750 lbs (340 kg) = 750 lbs (340 kg)	1500 lbs (680 kg) - 540 lbs (245 kg) = 960 lbs (435 kg)	1500 lbs (680 kg) - 150 lbs (68 kg) = 1350 lbs (612 kg)

Vehicle identification plate

Even if you have calculated the total cargo carefully, you should still make sure that the gross

vehicle weight rating and the gross axle weight rating are not exceeded. Details can be found on the vehicle identification plate on the B-pillar on the driver's side of the vehicle (▷ page 292).

Permissible Gross Vehicle Weight Rating (GVWR): the gross weight of the vehicle, all passengers, load and trailer load/noseweight (if applicable) must not exceed the permissible gross vehicle weight.

Gross Axle Weight Rating (GAWR): the maximum permissible weight that can be carried by one axle (front or rear axle).

To ensure that your vehicle does not exceed the maximum permissible values (gross vehicle weight and maximum gross axle weight rating), have your loaded vehicle (including driver, occupants, cargo, and full trailer load if applicable) weighed on a suitable vehicle weighbridge.

All about wheels and tires

Uniform Tire Quality Grading Standards

Overview of Tire Quality Grading Standards

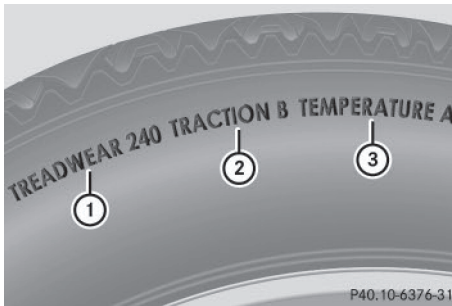

Uniform Tire Quality Grading Standards are U.S. government specifications. Their purpose is to provide drivers with uniform reliable information on tire performance data. Tire manufacturers have to grade tires using three performance factors: ① tread wear grade, ② traction grade and ③ temperature grade. These regulations do not apply to Canada. Nevertheless, all tires sold in North America are provided with the corresponding quality grading markings on the sidewall of the tire.

Quality grades can be found, where applicable, on the tire sidewall between tread shoulder and maximum section width.

Example:

- **Treadwear grade:** 200
- **Traction grade:** AA
- **Temperature grade:** A

All passenger car tires must conform to the statutory safety requirements in addition to these grades.

i The actual values for tires are vehicle-specific and may deviate from the values in the illustration.

Treadwear

The treadwear grade is a comparative rating based on the wear rate of the tire when tested under controlled conditions on a specified U.S. government course. For example, a tire graded 150 would wear one and one-half times as well on the government course as a tire graded 100.

The relative performance of tires depends upon the actual conditions of their use, however, and may depart significantly from the norm due to variations in driving habits, service practices and differences in road characteristics and climate.

Traction

⚠ WARNING

The traction grade assigned to this tire is based on straight-ahead braking traction tests, and does not include acceleration, cornering, hydroplaning, or peak traction characteristics.

! Avoid wheelspin. This can lead to damage to the drive train.

The traction grades – from highest to lowest – are AA, A, B and C. Those grades represent the tire's ability to stop on wet pavement as measured under controlled conditions on specified government test surfaces of asphalt and concrete. A tire marked C may have poor traction performance.

The safe speed on a wet, snow covered or icy road is always lower than on dry road surfaces. You should pay special attention to road conditions when temperatures are around freezing point.

Mercedes-Benz recommends a minimum tread depth of $\frac{1}{8}$ in (4 mm) on all four winter tires.

Observe the legally required minimum tire tread depth (▷ page 283). Winter tires can reduce the braking distance on snow-covered surfaces in comparison with summer tires. The braking distance is still much further than on surfaces that are not icy or covered with snow. Take appropriate care when driving.

Further information on winter tires (M+S tires) (▷ page 284).

Temperature

WARNING

The temperature grade for this tire is established for a tire that is properly inflated and not overloaded. Excessive speed, underinflation, or excessive loading, either separately or in combination, can cause excessive heat build-up and possible tire failure.

The temperature grades are A (the highest), B, and C, representing the tire's resistance to the generation of heat and its ability to dissipate heat when tested under controlled conditions on a specified indoor laboratory test wheel. Sustained high temperature can cause the material of the tire to degenerate and reduce tire life, and excessive temperature can lead to sudden tire failure. The grade C corresponds to a level of performance which all passenger car tires must meet under the Federal Motor Vehicle Safety Standard No. 109. Grades B and A represent higher levels of performance on the laboratory test wheel than the minimum required by law.

Tire labeling

Overview

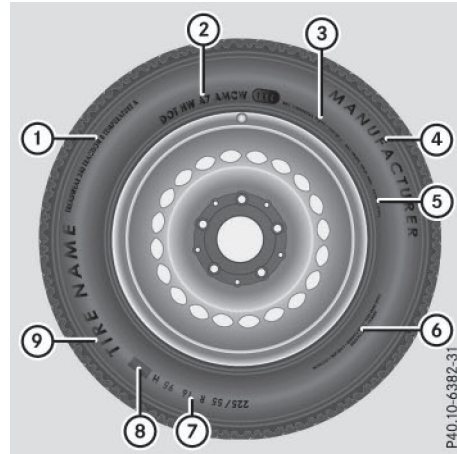

- ① Uniform Tire Quality Grading Standards (▷ page 300)
- ② Department of Transportation, Tire Identification Number (▷ page 299)
- ③ Maximum load rating (▷ page 298)
- ④ Maximum tire pressures (▷ page 288)
- ⑤ Manufacturer
- ⑥ Tire material (▷ page 299)
- ⑦ Tire size designation, load-bearing capacity and speed rating (▷ page 296)
- ⑧ Load index (▷ page 298)
- ⑨ Tire name

The markings described above are on the tire in addition to the tire name (sales designation) and the manufacturer's name.

i Tire data is vehicle-specific and may deviate from the data in the example.

Tire size designation, load-bearing capacity and speed rating

WARNING

Exceeding the stated tire load-bearing capacity and the approved maximum speed could lead to tire damage or the tire bursting. There is a risk of accident.

Therefore, only use tire types and sizes approved for your vehicle model. Observe the

tire load rating and speed rating required for your vehicle.

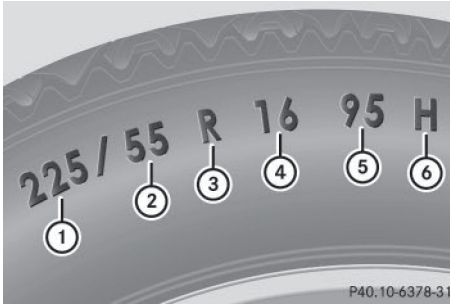

- ① Tire width
- ② Nominal aspect ratio in %
- ③ Tire code
- ④ Rim diameter
- ⑤ Load bearing index
- ⑥ Speed rating

General: depending on the manufacturer's standards, the size imprinted in the tire wall may not contain any letters or may contain one letter that precedes the size description.

If there is no letter preceding the size description (as shown above): these are passenger vehicle tires according to European manufacturing standards.

If "P" precedes the size description: these are passenger vehicle tires according to U.S. manufacturing standards.

If "LT" precedes the size description: these are light truck tires according to U.S. manufacturing standards.

If "T" precedes the size description: compact emergency wheels with high tire pressure that are only designed for temporary use in an emergency.

Tire width: tire width ① shows the nominal tire width in millimeters.

Aspect ratio: aspect ratio ② is the size ratio between the tire height and tire width and is shown in percent. The aspect ratio is calculated by dividing the tire width by the tire height.

Tire code: tire code ③ specifies the tire type. "R" represents radial tires; "D" represents diagonal tires; "B" represents diagonal radial tires.

Optionally, tires with a maximum speed of over 149 mph (240 km/h) may have "ZR" in the size

description, depending on the manufacturer (e.g. 245/40 ZR 18).

Rim diameter: rim diameter ④ is the diameter of the bead seat, not the diameter of the rim flange. The rim diameter is specified in inches (in).

Load-bearing index: load-bearing index ⑤ is a numerical code that specifies the maximum load-bearing capacity of a tire.

Do not overload the tires by exceeding the specified load limit. The maximum permissible load can be found on the vehicle's Tire and Loading Information placard on the B-pillar on the driver's side (▷ page 292).

Example:

Load-bearing index 91 indicates a maximum load of 1,356 lb (615 kg) that the tires can bear. For further information on the maximum tire load in kilograms and lbs, see (▷ page 298).

For further information on the load bearing index, see "Load index" (▷ page 298).

Speed rating: speed rating ⑥ specifies the approved maximum speed of the tire.

i Tire data is vehicle-specific and may deviate from the data in the example.

Regardless of the speed rating, always observe the speed limits. Drive carefully and adapt your driving style to the traffic conditions.

Summer tires

Index	Speed rating
Q	up to 100 mph (160 km/h)
R	up to 106 mph (170 km/h)
S	up to 112 mph (180 km/h)
T	up to 118 mph (190 km/h)
H	up to 130 mph (210 km/h)
V	up to 149 mph (240 km/h)
W	up to 168 mph (270 km/h)
Y	up to 186 mph (300 km/h)
ZR...Y	up to 186 mph (300 km/h)
ZR...(..Y)	over 186 mph (300 km/h)
ZR	over 149 mph (240 km/h)

- Optionally, tires with a maximum speed of over 149 mph (240 km/h) may have "ZR" in

the size description, depending on the manufacturer (e.g. 245/40 ZR18).

The service specification is made up of load-bearing index ⑤ and speed rating ⑥.

- If the size description of your tire includes "ZR" and there are no service specifications, ask the tire manufacturer in order to find out the maximum speed.

If a service specification is available, the maximum speed is limited according to the speed rating in the service specification. Example: 245/40 ZR18 97 Y. In this example, "97 Y" is the service specification. The letter "Y" represents the speed rating. The maximum speed of the tire is limited to 186 mph (300 km/h).

- The size description for all tires with maximum speeds of over 186 mph (300 km/h) must include "ZR" **and** the service specification must be given in parentheses. Example: 275/40 ZR 18 (99 Y). Speed rating "Y" indicates that the maximum speed of the tire is over 186 mph (300 km/h). Ask the tire manufacturer about the maximum speed.

All-weather tires and winter tires

Index	Speed rating
Q M+S ¹	up to 100 mph (160 km/h)
T M+S ¹	up to 118 mph (190 km/h)
H M+S ¹	up to 130 mph (210 km/h)
V M+S ¹	up to 149 mph (240 km/h)

- i** Not all tires with the M+S marking provide the driving characteristics of winter tires. In addition to the M+S marking, winter tires also have the  snowflake symbol on the tire wall. Tires with this marking fulfill the requirements of the Rubber Manufacturers Association (RMA) and the Rubber Association of Canada (RAC) regarding the tire traction on snow. They have been especially developed for driving on snow.

An electronic speed limiter prevents your vehicle from exceeding a speed of 130 mph (210 km/h).

The speed rating of tires mounted at the factory may be higher than the maximum speed that the electronic speed limiter permits.

¹ Or M+S  for winter tires.

Make sure that your tires have the required speed rating, e.g. when buying new tires. The required speed rating for your vehicle can be found in the "Tires" section (▷ page 306).

Further information about reading tire data can be obtained from any qualified specialist workshop.

Load index



In addition to the load-bearing index, load index ① may be imprinted after the letters that identify speed rating on the sidewall of the tire. Speed rating (▷ page 296).

- If no specification is given: no text (as in the example above), represents a standard load (SL) tire
- XL or Extra Load: represents a reinforced tire
- Light Load: represents a light load tire
- C, D, E: represents a load range that depends on the maximum load that the tire can carry at a certain pressure

- i** Tire data is vehicle-specific and may deviate from the data in the example.

Maximum load rating

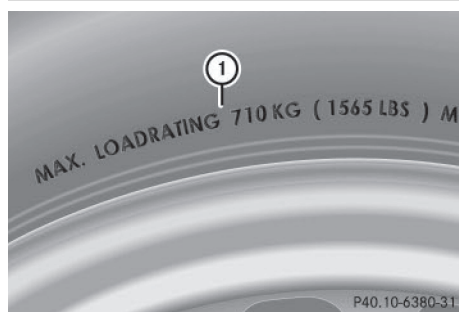

Maximum tire load ① is the maximum permissible weight for which the tire is approved.

Do not overload the tires by exceeding the specified load limit. The maximum permissible load can be found on the vehicle's Tire and Loading Information placard on the B-pillar on the driver's side (▷ page 292).

- ① The actual values for tires are vehicle-specific and may deviate from the values in the illustration.

DOT, Tire Identification Number (TIN)

US tire regulations stipulate that every tire manufacturer or retreader must imprint a TIN in or on the sidewall of each tire produced.

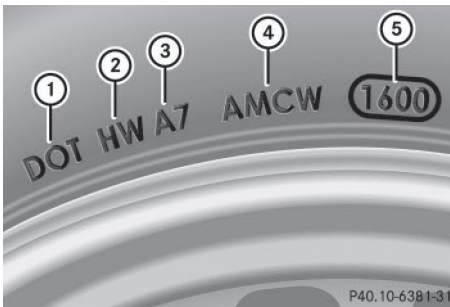

The TIN is a unique identification number. The TIN enables the tire manufacturers or retreaders to inform purchasers of recalls and other safety-relevant matters. It makes it possible for the purchaser to easily identify the affected tires.

The TIN is made up of manufacturer identification code ②, tire size ③, tire type code ④ and manufacturing date ⑤.

DOT (Department of Transportation): tire symbol ① marks that the tire complies with the requirements of the U.S. Department of Transportation.

Manufacturer identification code: manufacturer identification code ② provides details on the tire manufacturer. New tires have a code with two symbols. Retreaded tires have a code with four symbols.

For further information about retreaded tires, see (▷ page 306).

Tire size: identifier ③ describes the tire size.

Tire type code: tire type code ④ can be used by the manufacturer as a code to describe specific characteristics of the tire.

Date of manufacture: date of manufacture ⑤ provides information about the age of a tire. The first and second positions represent the week of manufacture, starting with "01" for the first calendar week. Positions three and four represent the year of manufacture. For example, a tire that is marked with "3208", was manufactured in week 32 in 2008.

- ① Tire data is vehicle-specific and may deviate from the data in the example.

Tire characteristics

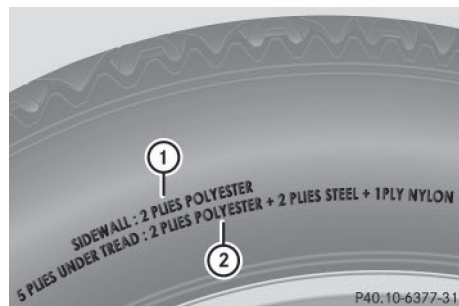

This information describes the type of tire cord and the number of layers in sidewall ① and under tire tread ②.

- ① Tire data is vehicle-specific and may deviate from the data in the example.

Definition of terms for tires and loading

Tire ply composition and material used

Describes the number of plies or the number of layers of rubber-coated fabric in the tire tread and sidewall. These are made of steel, nylon, polyester and other materials.

Bar

Metric unit for tire pressure. 14.5038 pounds per square inch (psi) and 100 kilopascals (kPa) are the equivalent of 1 bar.

DOT (Department of Transportation)

DOT-marked tires fulfill the requirements of the U S Department of Transportation.

Normal occupant weight

The number of occupants for which the vehicle is designed multiplied by 68 kilograms (150 lbs).

Uniform Tire Quality Grading Standards

A uniform standard to grade the quality of tires with regards to tread quality, tire traction and temperature characteristics. The quality grading assessment is made by the manufacturer following specifications from the U.S. government. The ratings are molded into the sidewall of the tire.

Recommended tire pressures

The recommended tire pressure applies to the tires mounted at the factory.

The Tire and Loading Information placard contains the recommended tire pressures for cold tires on a fully loaded vehicle and for the maximum permissible vehicle speed.

The tire pressure table contains the recommended pressures for cold tires for various operating conditions, i.e. differing load and speed conditions.

Increased vehicle weight due to optional equipment

The combined weight of all standard and optional equipment available for the vehicle, regardless of whether it is actually installed on the vehicle or not.

Rim

This is the part of the wheel on which the tire is mounted.

GAWR (Gross Axle Weight Rating)

The GAWR is the maximum gross axle weight rating. The actual load on an axle must never exceed the gross axle weight rating. The gross axle weight rating can be found on the vehicle identification plate on the B-pillar on the driver's side.

Speed rating

The speed rating is part of the tire identification. It specifies the speed range for which the tire is approved.

GVW (Gross Vehicle Weight)

The gross vehicle weight includes the weight of the vehicle including fuel, tools, the spare wheel, accessories installed, occupants, luggage and the drawbar noseweight, if applicable. The gross vehicle weight must not exceed the gross vehicle weight rating GVWR as specified on the vehicle identification plate on the B-pillar on the driver's side.

GVWR (Gross Vehicle Weight Rating)

The GVWR is the maximum permissible gross weight of a fully loaded vehicle (the weight of the vehicle including all accessories, occupants, fuel, luggage and the drawbar noseweight, if applicable). The gross vehicle weight rating is specified on the vehicle identification plate on the B-pillar on the driver's side.

Maximum loaded vehicle weight

The maximum weight is the sum of:

- the curb weight of the vehicle
- the weight of the accessories
- the load limit
- the weight of the factory installed optional equipment

Kilopascal (kPa)

Metric unit for tire pressure. 6.9 kPa corresponds to 1 psi. Another unit for tire pressure is bar. 100 kilopascals (kPa) are the equivalent of 1 bar.

Load index

In addition to the load-bearing index, the load index may also be imprinted on the sidewall of the tire. This specifies the load-bearing capacity more precisely.

Curb weight

The weight of a vehicle with standard equipment including the maximum capacity of fuel, oil and coolant. It also includes the air-conditioning system and optional equipment if these are installed in the vehicle, but does not include passengers or luggage.

Maximum load rating

The maximum tire load is the maximum permissible weight in kilograms or lbs for which a tire is approved.

Maximum permissible tire pressure

Maximum permissible tire pressure for one tire.

Maximum load on one tire

Maximum load on one tire. This is calculated by dividing the maximum axle load of one axle by two.

PSI (pounds per square inch)

A standard unit of measure for tire pressure.

Aspect ratio

Relationship between tire height and tire width in percent.

Tire pressure

This is pressure inside the tire applying an outward force to each square inch of the tire's surface. The tire pressure is specified in pounds per square inch (psi), in kilopascal (kPa) or in bar. The tire pressure should only be corrected when the tires are cold.

Cold tire pressure

The tires are cold:

- if the vehicle has been parked with the tires out of direct sunlight for at least three hours and
- if the vehicle has not been driven further than 1 mile (1.6 km)

Tread

The part of the tire that comes into contact with the road.

Bead

The tire bead ensures that the tire sits securely on the wheel. There are several steel wires in the bead to prevent the tire from coming loose from the wheel rim.

Sidewall

The part of the tire between the tread and the bead.

Weight of optional extras

The combined weight of those optional extras that weigh more than the replaced standard parts and more than 2.3 kg (5 lbs). These optional extras, such as high-performance brakes, level control, a roof rack or a high-performance battery, are not included in the curb weight and the weight of the accessories.

TIN (Tire Identification Number)

This is a unique identifier which can be used by a tire manufacturer to identify tires, for example for a product recall, and thus identify the purchasers. The TIN is made up of the manufacturer's identity code, tire size, tire type code and the manufacturing date.

Load bearing index

The load bearing index (also load index) is a code that contains the maximum load bearing capacity of a tire.

Traction

Traction is the result of friction between the tires and the road surface.

Treadwear indicators

Narrow bars (tread wear bars) that are distributed over the tire tread. If the tire tread is level with the bars, the wear limit of $\frac{1}{16}$ in (1.6 mm) has been reached.

Occupant distribution

The distribution of occupants in a vehicle at their designated seating positions.

Total load limit

Nominal load and luggage load plus 68 kg (150 lbs) multiplied by the number of seats in the vehicle.

Changing a wheel**Flat tire**

The "Breakdown assistance" section (> page 266) contains information and notes on how to deal with a flat tire. Information on driving with MOExtended tires in the event of a flat tire can be found under "MOExtended tires (tires with run-flat characteristics)" (> page 267).

Rotating the wheels **WARNING**

Interchanging the front and rear wheels may severely impair the driving characteristics if the wheels or tires have different dimensions. The wheel brakes or suspension components may also be damaged. There is a risk of accident.

Rotate front and rear wheels only if the wheels and tires are of the same dimensions.

- ! On vehicles equipped with a tire pressure monitor, electronic components are located in the wheel.

Tire-mounting tools should not be used near the valve. This could damage the electronic components.

Only have tires changed at a qualified specialist workshop.

Observe the instructions and safety notes in the "Changing a wheel" section (▷ page 301).

The wear patterns on the front and rear tires differ, depending on the operating conditions. Rotate the wheels before a clear wear pattern has formed on the tires. Front tires typically wear more on the shoulders and the rear tires in the center.

On vehicles that have the same size front and rear wheels, you can rotate the wheels according to the intervals in the tire manufacturer's warranty book in your vehicle documents. If no warranty book is available, the tires should be rotated every 3,000 to 6,000 miles (5,000 to 10,000 km). Depending on tire wear, this may be required earlier. Do not change the direction of wheel rotation.

Clean the contact surfaces of the wheel and the brake disc thoroughly every time a wheel is rotated. Check the tire pressure and, if necessary, restart the tire pressure loss warning system (Canada only) or the tire pressure monitor (USA only).

Direction of rotation

Tires with a specified direction of rotation have additional benefits, e.g. if there is a risk of hydroplaning. These advantages can only be gained if the tires are installed corresponding to the direction of rotation.

An arrow on the sidewall of the tire indicates its correct direction of rotation.

Storing wheels

Store wheels that are not being used in a cool, dry and preferably dark place. Protect the tires from oil, grease, gasoline and diesel.

Mounting a wheel

Preparing the vehicle

- ▶ Stop the vehicle on solid, non-slippery and level ground.
- ▶ Apply the electric parking brake manually.
- ▶ Bring the front wheels into the straight-ahead position.
- ▶ Shift the transmission to position **P**.
- ▶ Switch off the engine.
- ▶ **Vehicles without KEYLESS-GO:** remove the SmartKey from the ignition lock.
- ▶ **Vehicles with KEYLESS-GO start-function or KEYLESS-GO:** open the driver's door. The vehicle electronics now have status **0**. This is the same as the SmartKey having been removed.
- ▶ **Vehicles with KEYLESS-GO start-function or KEYLESS-GO:** remove the Start/Stop button from the ignition lock (▷ page 121).
- ▶ Make sure that the engine cannot be started via your smartphone (▷ page 122).
- ▶ If included in the vehicle equipment, remove the tire-change tool kit from the vehicle.
- ▶ Safeguard the vehicle against rolling away (▷ page 140).

Securing the vehicle to prevent it from rolling away

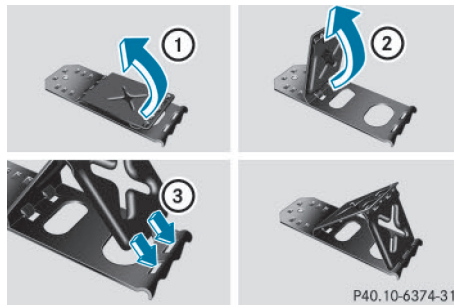

If your vehicle is equipped with a wheel chock, it can be found in the tire-change tool kit (▷ page 266).

The folding wheel chock is an additional safety measure to prevent the vehicle from rolling away, for example when changing a wheel.

- ▶ Fold both plates upwards ①.
- ▶ Fold out lower plate ②.
- ▶ Guide the lugs on the lower plate fully into the openings in base plate ③.

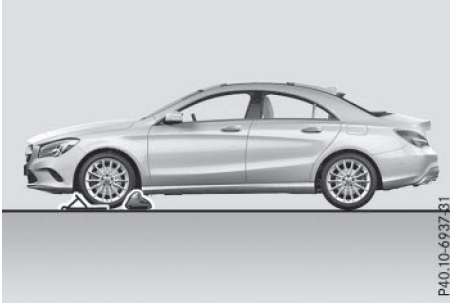

P40.10-6937-31

- ▶ Place chocks or other suitable items under the front and rear of the wheel that is diagonally opposite the wheel you wish to change.

Raising the vehicle

WARNING

If you do not position the jack correctly at the appropriate jacking point of the vehicle, the jack could tip over with the vehicle raised. There is a risk of injury.

Only position the jack at the appropriate jacking point of the vehicle. The base of the jack must be positioned vertically, directly under the jacking point of the vehicle.

- ❗ The jack is designed exclusively for jacking up the vehicle at the jacking points. Otherwise, your vehicle could be damaged.

Observe the following when raising the vehicle:

- To raise the vehicle, only use the vehicle-specific jack that has been tested and approved by Mercedes-Benz. If used incorrectly, the jack could tip over with the vehicle raised.
- The jack is designed only to raise and hold the vehicle for a short time while a wheel is being changed. It must not be used for performing maintenance work under the vehicle.
- Avoid changing the wheel on uphill and downhill slopes.
- Before raising the vehicle, secure it from rolling away by applying the parking brake and

inserting wheel chocks. Do not disengage the parking brake while the vehicle is raised.

- The jack must be placed on a firm, flat and non-slip surface. On a loose surface, a large, flat, load-bearing underlay must be used. On a slippery surface, a non-slip underlay must be used, e.g. rubber mats.
- Do not use wooden blocks or similar objects as a jack underlay. Otherwise, the jack will not be able to achieve its load-bearing capacity due to the restricted height.
- Make sure that the distance between the underside of the tires and the ground does not exceed 1.2 in (3 cm).
- Never place your hands and feet under the raised vehicle.
- Do not lie under the vehicle.
- Do not start the engine when the vehicle is raised.
- Do not open or close a door or the trunk lid when the vehicle is raised.
- Make sure that no persons are present in the vehicle when the vehicle is raised.

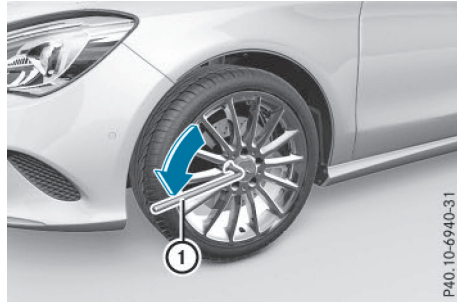

P40.10-6940-31

- ▶ Using lug wrench ①, loosen the bolts on the wheel you wish to change by about one full turn. Do not unscrew the bolts completely.

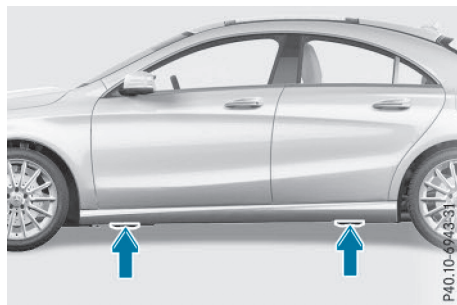

P40.10-6943-31

Jacking points

The jacking points are located just behind the front wheel housings and just in front of the rear wheel housings (arrows).

Mercedes-AMG vehicles and vehicles with AMG equipment: to protect the vehicle body, the vehicle has covers installed next to the jacking points on the outer sills.



Covers, front (example: vehicles with AMG equipment)

- ▶ **Mercedes-AMG vehicles and vehicles with AMG equipment:** fold cover ② upwards.

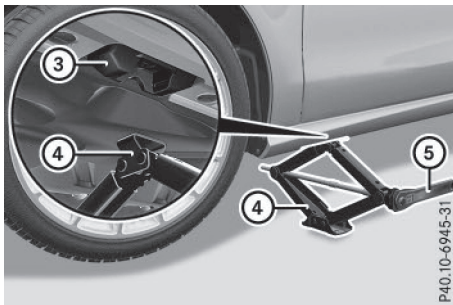

- ▶ Take ratchet wrench ⑤ out of the vehicle tool kit and place it on the hexagon nut of jack ④ so that the letters **AUF** are visible.
- ▶ Position jack ④ at jacking point ③.

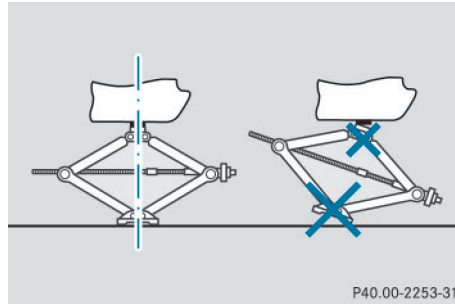

- ▶ Make sure the foot of the jack is directly beneath the jacking point.
- ▶ Turn ratchet wrench ⑤ until jack ④ sits completely on jacking point ③ and the base of the jack lies evenly on the ground.
- ▶ Turn ratchet wrench ⑤ until the tire is raised a maximum of 1.2 in (3 cm) from the ground.

Removing a wheel

- ⚠ Do not place wheel bolts in sand or on a dirty surface. The bolt and wheel hub threads could otherwise be damaged when you screw them in.
- ▶ Unscrew the wheel bolts.
- ▶ Remove the wheel.

Mounting a new wheel

⚠ WARNING

Oiled or greased wheel bolts or damaged wheel bolts/hub threads can cause the wheel bolts to come loose. As a result, you could lose a wheel while driving. There is a risk of accident.

Never oil or grease wheel bolts. In the event of damage to the threads, contact a qualified specialist workshop immediately. Have the damaged wheel bolts or hub threads replaced/renewed. Do not continue driving.

⚠ WARNING

If you tighten the wheel bolts or wheel nuts when the vehicle is raised, the jack could tip over. There is a risk of injury.

Only tighten the wheel bolts or wheel nuts when the vehicle is on the ground.

Always pay attention to the instructions and safety notes in the "Changing a wheel" section (▷ page 301).

Only use wheel bolts that have been designed for the wheel and the vehicle. For safety reasons, Mercedes-Benz recommends that you only use wheel bolts which have been approved for Mercedes-Benz vehicles and the respective wheel.

! To prevent damage to the paintwork, hold the wheel securely against the wheel hub while screwing in the first wheel bolt.



P40.10-6941-31

- ▶ Clean the wheel and wheel hub contact surfaces.
- ▶ Place the new wheel on the wheel hub and push it on.
- ▶ Tighten the wheel bolts until they are finger-tight.

Lowering the vehicle

WARNING

The wheels could work loose if the wheel nuts and bolts are not tightened to the specified tightening torque. There is a risk of accident.

Have the tightening torque immediately checked at a qualified specialist workshop after a wheel is changed.

- ▶ Place the ratchet wrench onto the hexagon nut of the jack so that the letters **AB** are visible.
- ▶ Turn the ratchet wrench until the vehicle is once again standing firmly on the ground.
- ▶ Place the jack to one side.

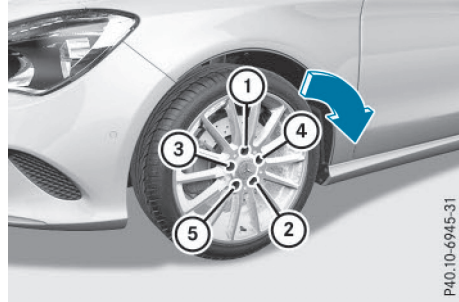

P40.10-6945-31

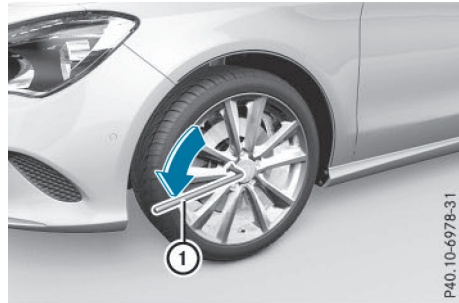

P40.10-6978-31

- ▶ Tighten the wheel bolts evenly in a crosswise pattern in the sequence indicated (① to ⑤). The specified tightening torque is **96 lb-ft (130 Nm)**.
- ▶ Turn the jack back to its initial position.
- ▶ Stow the jack and the rest of the vehicle tools in the vehicle again.
- ▶ **Mercedes-AMG vehicles and vehicles with AMG equipment:** insert the cover into the outer sill.
- ▶ Check the tire pressure of the newly mounted wheel and adjust it if necessary. Observe the recommended tire pressure (▷ page 285).

Canada only: as long as you are driving with the emergency spare wheel mounted, the tire pressure loss warning system cannot function reliably. Only restart the tire pressure loss warning system when the defective wheel has been replaced with a new wheel.

Vehicles with tire pressure monitor (USA only): all mounted wheels must be equipped with functioning sensors.

Wheel and tire combinations

General notes

You can ask for information regarding permitted wheel/tire combinations at an authorized Mercedes-Benz Center.

You should regularly check the pressure of the emergency spare wheel, particularly prior to long trips, and correct the pressure as necessary (▷ page 285). The value on the wheel is valid.

! For safety reasons, Mercedes-Benz recommends that you only use tires and wheels which have been approved by Mercedes-Benz specifically for your vehicle.

These tires have been specially adapted for use with the control systems, such as ABS or ESP®, and are marked as follows:

- MO = Mercedes-Benz Original
- MOE = Mercedes-Benz Original Extended (tires featuring run-flat characteristics)
- MO1 = Mercedes-Benz Original (only certain AMG tires)

Mercedes-Benz Original Extended tires may only be used on wheels that have been specifically approved by Mercedes-Benz.

Only use tires, wheels or accessories tested and approved by Mercedes-Benz. Certain characteristics, e.g. handling, vehicle noise emissions or fuel consumption, may otherwise be adversely affected. In addition, when driving with a load, tire dimension variations could cause the tires to come into contact with the bodywork and axle components. This could result in damage to the tires or the vehicle.

Mercedes-Benz accepts no liability for damage resulting from the use of tires, wheels or accessories other than those tested and approved.

Information on tires, wheels and approved combinations can be obtained from any qualified specialist workshop.

! Retreaded tires are neither tested nor recommended by Mercedes-Benz, since previous damage cannot always be detected on retreaded tires. As a result, Mercedes-Benz cannot guarantee vehicle safety if retreaded tires are mounted. Do not mount used tires if you have no information about their previous usage.

The recommended pressures for various operating conditions can be found:

- on the Tire and Loading Information placard on the B-pillar on the driver's side
- in the tire pressure table in the fuel filler flap

Observe the notes on recommended tire pressures under various operating conditions (▷ page 285).

Check tire pressures regularly, and only when the tires are cold. Comply with the maintenance recommendations of the tire manufacturer in the vehicle document wallet.

Notes on the vehicle equipment – always equip the vehicle:

- with tires of the same size on a given axle (left and right)
- with the same type of tire (summer tires, MOExtended tires, winter tires)

Exception: it is permissible to install a different type or make in the event of a flat tire. Observe the "MOExtended tires (tires with run-flat characteristics)" section (▷ page 267).

Vehicles equipped with MOExtended tires are not equipped with a TIREFIT kit at the factory. It is therefore recommended that you additionally equip your vehicle with a TIREFIT kit if you mount tires that do not feature run-flat properties, e.g. winter tires. A TIREFIT kit may be obtained from a qualified specialist workshop.

Information regarding technical data

- i** The data stated here specifically refers to a vehicle with standard equipment. Consult an authorized Mercedes-Benz Center for the data for all vehicle variants and trim levels.

Vehicle electronics

Installing two-way radios and mobile phones (RF transmitters)

⚠ WARNING

The electromagnetic radiation from modified or incorrectly retrofitted RF-transmitters can interfere with the vehicle electronics. This can compromise the operational safety of the vehicle. There is a risk of an accident.

You should have all work to electrical and electronic equipment carried out at a qualified specialist workshop.

⚠ WARNING

The electromagnetic radiation from incorrectly operated RF transmitters can interfere with the vehicle electronics, for example:

- if the RF transmitter is not connected with an exterior antenna
- the exterior antenna has been installed incorrectly or is not a low-reflection type

This can compromise the operational safety of the vehicle. There is a risk of an accident.

Have the low-reflection exterior antenna mounted at a qualified specialist workshop. When operating RF transmitters in the vehicle, always connect them with the low-reflection exterior antenna.

- !** The operating permit may be invalidated if the instructions for installation and use of RF transmitters are not observed.

In particular, the following conditions must be complied with:

- only approved wavebands may be used.
- observe the maximum permissible output in these wavebands.
- only approved antenna positions may be used.

Excessive levels of electromagnetic radiation may cause damage to your health and the health of others. Using an exterior antenna takes into account current scientific discussions relating to the possible health hazards that may result from electromagnetic fields.

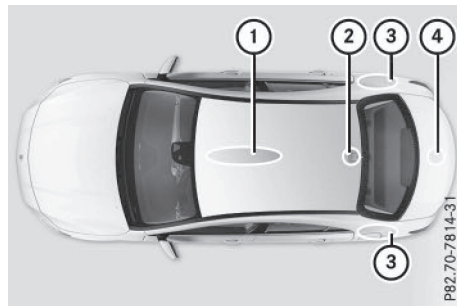

Approved antenna positions

- ① Front roof area
- ② Rear roof area
- ③ Rear fender
- ④ Trunk lid

- i** On vehicles with panorama roof with power tilt/sliding panel, installing an antenna to the front or rear roof area is not permitted.

On the rear fenders, it is recommended to position the antenna on the side of the vehicle closest to the center of the road.

Use the Technical Specification ISO/TS 21609 when retrofitting RF transmitters (Road Vehicles - EMC guidelines for installation of aftermarket radio frequency transmitting equipment). Observe the legal requirements for accessory parts.

If your vehicle has installations for two-way radio equipment, use the power supply or antenna connections intended for use with the basic wiring. Be sure to observe the manufacturer's Supplement when installing.

Deviations with respect to frequency bands, maximum transmission outputs or antenna positions must be approved by Mercedes-Benz.

The maximum transmission output (PEAK) at the base of the antenna must not exceed the following values:

Frequency band	Maximum transmission output
Short wave 3 - 54 MHz	100 W
4 m waveband 74 - 88 MHz	30 W
2 m waveband 144 - 174 MHz	50 W
Trunked radio system/ Tetra 380 - 460 MHz	10 W
70 cm waveband 400 - 460 MHz	35 W
Mobile communications (2G/3G/4G)	10 W

The following can be used in the vehicle without restrictions:

- RF transmitters with a maximum transmission output of up to 100 mW
- RF transmitters with transmitter frequencies in the 380 - 410 MHz frequency band and a maximum transmission output of up to 2 W (trunked radio system/Tetra)
- Mobile phones (2G/3G/4G)

There is no restriction for antenna positions on the outside of the vehicle for the following frequency bands:

- Trunked radio system/Tetra
- 70 cm waveband
- 2G/3G/4G

Identification plates

Vehicle identification plate with vehicle identification number (VIN)



- Open the driver's door.
You will see vehicle identification plate ①.

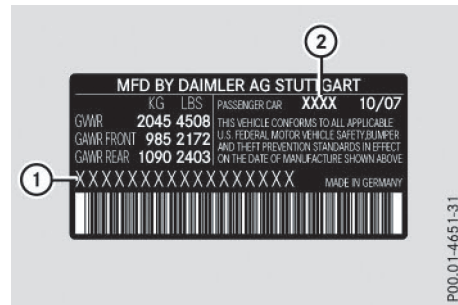

Example: vehicle identification plate (USA only)

- ① VIN
② Paint code

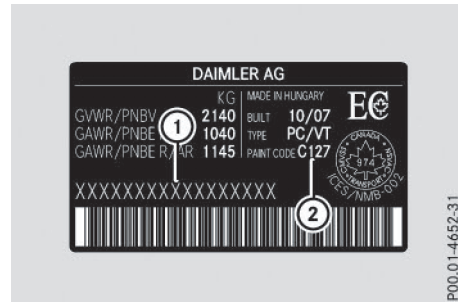

Example: vehicle identification plate (Canada only)

- ① VIN
② Paint code
 ⓘ The data shown on the vehicle identification plate is used only as an example. This data is

different for every vehicle and can deviate from the data shown here. You can find the data applicable to your vehicle on the vehicle identification plate.

Vehicle identification number (VIN)

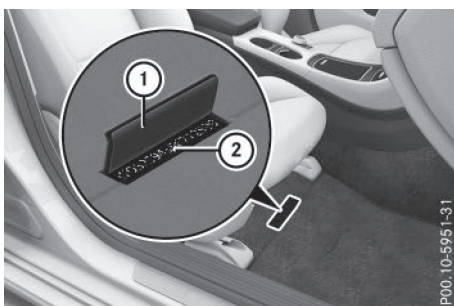

- ▶ Slide the right-hand front seat to its rearmost position.
- ▶ Fold floor covering ① upwards. You will see VIN ②.

The VIN can also be found on the vehicle identification plate (▷ page 308).

The VIN can also be found at the lower edge of the windshield (▷ page 309).

Engine number

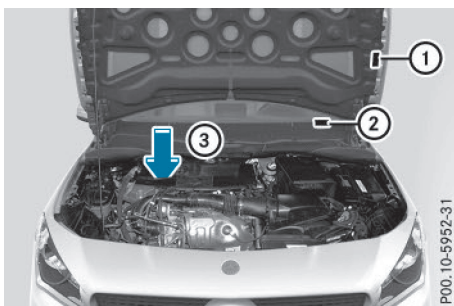

- ① Emission control information plate, including the certification of both federal and Californian emissions standards
- ② VIN (on the lower edge of the windshield)
- ③ Engine number (stamped into the crankcase)

Service products and filling capacities

Important safety notes

WARNING

Service products may be poisonous and hazardous to health. There is a risk of injury.

Comply with instructions on the use, storage and disposal of service products on the labels of the respective original containers. Always store service products sealed in their original containers. Always keep service products out of the reach of children.

Environmental note

Dispose of service products in an environmentally responsible manner.

Service products include the following:

- Fuels
- Lubricants (e.g. engine oil, transmission oil)
- Coolant
- Brake fluid
- Windshield washer fluid
- Climate control system refrigerant

Components and service products must match. Only use products recommended by Mercedes-Benz. Damage which is caused by the use of products which have not been recommended is not covered by the Mercedes-Benz warranty or goodwill gestures. They are listed in this Mercedes-Benz Operator's Manual in the appropriate section.

Information on tested and approved products can be obtained at a Mercedes-Benz Service Center or on the Internet at <http://bevo.mercedes-benz.com>.

You can recognize service products approved by Mercedes-Benz by the following inscription on the containers:

- MB-Freigabe (e.g. MB-Freigabe 229.51)
- MB-Approval (e.g. MB-Approval 229.51)

Other designations or recommendations indicate a level of quality or a specification in accordance with an MB Sheet Number (e.g. MB 229.5). They have not necessarily been approved by Mercedes-Benz.

Other identifications, for example:

- 0 W-30
- 5 W-30
- 5 W-40

Fuel

Important safety notes

WARNING

Fuel is highly flammable. If you handle fuel incorrectly, there is a risk of fire and explosion.

You must avoid fire, open flames, creating sparks and smoking. Switch off the engine and, if applicable, the auxiliary heating before refueling.

WARNING

Fuel is poisonous and hazardous to health. There is a risk of injury.

You must make sure that fuel does not come into contact with your skin, eyes or clothing and that it is not swallowed. Do not inhale fuel vapors. Keep fuel away from children.

If you or others come into contact with fuel, observe the following:

- Wash away fuel from skin immediately using soap and water.
- If fuel comes into contact with your eyes, immediately rinse them thoroughly with clean water. Seek medical assistance without delay.
- If fuel is swallowed, seek medical assistance without delay. Do not induce vomiting.
- Immediately change out of clothing which has come into contact with fuel.

Tank capacity

Model	Total capacity
CLA 250	13.2 US gal (50.0 l)
All other models	14.8 US gal (56.0 l)

Model	Of which reserve
Mercedes-AMG vehicles	Approx. 2.1 US gal (8.0 l)
All other models	Approx. 1.6 US gal (6.0 l)

Gasoline

Fuel grade

 Do not use diesel to refuel vehicles with a gasoline engine. Do not switch on the ignition if you accidentally refuel with the wrong fuel. Otherwise, the fuel will enter the fuel system. Even small amounts of the wrong fuel could result in damage to the fuel system and the engine. Notify a qualified specialist workshop and have the fuel tank and fuel lines drained completely.

 Only refuel using unleaded premium grade gasoline with at least 91 AKI/95 RON.

 E10 fuel contains up to 10% bioethanol. Your vehicle is E10-compatible. You can refuel your vehicle using E10 fuel.

 Only use the fuel recommended. Operating the vehicle with other fuels can lead to damage to the fuel system, engine and exhaust system.

 Do not use the following:

- E15 (gasoline with 15% ethanol)
- E85 (gasoline with 85% ethanol)
- E100 (100% ethanol)
- M15 (gasoline with 15% methanol)
- M30 (gasoline with 30% methanol)
- M85 (gasoline with 85% methanol)

- M100 (100% methanol)
- Gasoline with metalliferous additives
- Diesel

Do not mix such fuels with the fuel recommended for your vehicle.

! To ensure the longevity and full performance of the engine, only premium-grade unleaded gasoline must be used.

If standard unleaded gasoline is unavailable and you have to refuel with unleaded gasoline of a lower grade, observe the following precautions:

- Only fill the fuel tank to half full with regular unleaded gasoline and fill the rest with premium-grade unleaded gasoline as soon as possible.
- Do not drive at the maximum speed.
- Avoid sudden acceleration and engine speeds over 3,000 rpm.

You will usually find information about the fuel grade on the pump. If you cannot find the label on the pump, ask the staff for assistance.

i For further information, consult a qualified specialist workshop or visit <http://www.mbusa.com> (USA only).

CLA 250, CLA 250 Sport, CLA 250 4MATIC, CLA 250 Sport 4MATIC: as a temporary measure, if the recommended fuel is not available, you may also use regular unleaded gasoline with an octane rating of 88 AKI/93 RON.

All other models: as a temporary measure, if the recommended fuel is not available, you may also use regular unleaded gasoline with an octane rating of 87 AKI/91 RON. This may reduce engine performance and increase fuel consumption. Avoid driving at full throttle and sudden acceleration. Never refuel using gasoline with a lower AKI.

Information on refueling (▷ page 138).

Additives

! Operating the engine with fuel additives added later can lead to engine failure. Do not mix fuel additives with fuel. This does not include additives for the removal and prevention of residue buildup. Gasoline must only be mixed with additives recommended by Mercedes-Benz. Comply with the instructions for use on the product label. More information about recommended additives can be

obtained from any authorized Mercedes-Benz Center.

Mercedes-Benz recommends that you use branded fuels that have additives.

The fuel quality available in some countries may not be sufficient. Residue could build up in the fuel injection system as a result. In such cases, and in consultation with an authorized Mercedes-Benz Center, the fuel may be mixed with the cleaning additive recommended by Mercedes-Benz. You must observe the notes and mixing ratios specified on the container.

Engine oil

General notes



! Never use engine oil or an oil filter of a specification other than is necessary to fulfill the prescribed service intervals. Do not change the engine oil or oil filter in order to achieve longer replacement intervals than those prescribed. You could otherwise cause engine damage or damage to the exhaust gas aftertreatment.

Follow the instructions in the service interval display regarding the oil change. Otherwise, you may damage the engine and the exhaust gas aftertreatment.

When handling engine oil, observe the important safety notes on service products (▷ page 309).

The engine oils are matched to the performance of Mercedes-Benz engines and service intervals. You should therefore only use engine oils and oil filters that are approved for vehicles with maintenance systems.

For a list of approved engine oils and oil filters, consult an authorized Mercedes-Benz Center. Or visit the website <http://bevo.mercedes-benz.com>.

The table shows which engine oils have been approved for your vehicle.

Model	MB-Freigabe or MB-Approval
All models	229.5

Use only SAE 0W-40 or SAE 5W-40 engine oils for Mercedes-AMG vehicles.

- i** MB approval is indicated on the oil containers.

Filling capacities

The following values refer to an oil change including the oil filter.

Model	Capacity
Mercedes-AMG vehicles	5.8 US qt (5.5 l)
All other models	5.9 US qt (5.6 l)

Additives

- !** Do not use any additives in the engine oil. This could damage the engine.

Brake fluid

WARNING

The brake fluid constantly absorbs moisture from the air. This lowers the boiling point of the brake fluid. If the boiling point of the brake fluid is too low, vapor pockets may form in the brake system when the brakes are applied hard. This would impair braking efficiency. There is a risk of an accident.

You should have the brake fluid renewed at the specified intervals.

When handling brake fluid, observe the important safety notes on service products (▷ page 309).

The brake fluid change intervals can be found in the Maintenance Booklet.

Only use brake fluid approved by Mercedes-Benz in accordance with MB-Freigabe or MB-Approval 331.0.

Information about approved brake fluid can be obtained at any qualified specialist workshop or

on the Internet at <http://bevo.mercedes-benz.com>.

- i** Have the brake fluid regularly replaced at a qualified specialist workshop and the replacement confirmed in the Maintenance Booklet.

Coolant

Important safety notes

WARNING

If antifreeze comes into contact with hot components in the engine compartment, it may ignite. There is a risk of fire and injury.

Let the engine cool down before you add antifreeze. Make sure that antifreeze is not spilled next to the filler neck. Thoroughly clean the antifreeze from components before starting the engine.

- !** Only add coolant that has been premixed with the desired antifreeze protection. You could otherwise damage the engine. Further information on coolants can be found in the Mercedes-Benz Specifications for Service Products, MB BeVo 310.1, e.g. on the Internet at <http://bevo.mercedes-benz.com>. Or contact a qualified specialist workshop.
- !** Always use a suitable coolant mixture, even in countries where high temperatures prevail. Otherwise, the engine cooling system is not sufficiently protected from corrosion and overheating.
- i** Have the coolant regularly replaced at a qualified specialist workshop and the replacement confirmed in the Maintenance Booklet.

Comply with the important safety precautions for service products when handling coolant (▷ page 309).

The coolant is a mixture of water and corrosion inhibitor/antifreeze concentrate. It performs the following tasks:

- Anti-corrosion protection
- Antifreeze protection
- Raising the boiling point

If the coolant has antifreeze protection down to -35 °F (-37 °C), the boiling point of the coolant

during operation is approximately 266 °F (130 °C).

The antifreeze concentrate/corrosion inhibitor concentration in the engine cooling system should:

- be at least 50%. This will protect the engine cooling system against freezing down to approximately -35 °F (-37 °C)
- not exceed 55% (antifreeze protection down to -49 °F [-45 °C]). Otherwise, heat will not be dissipated as effectively

Mercedes-Benz recommends a coolant or corrosion inhibitor/antifreeze concentrate in accordance with MB Specifications for Service Products 310.1.

- i** When the vehicle is first delivered, it is filled with a coolant mixture that ensures adequate antifreeze and anti-corrosion protection.
- i** The coolant is checked with every maintenance interval at a qualified specialist workshop.

Filling capacities

Model	Capacity
Mercedes-AMG vehicles	Approx. 12.6 US qt (11.9 l)
All other models	Approx. 8.2 US qt (7.8 l)

Windshield washer system

Important safety notes

WARNING

Windshield washer concentrate could ignite if it comes into contact with hot engine components or the exhaust system. There is a risk of fire and injury.

Make sure that no windshield washer concentrate is spilled next to the filler neck.

- !** Only MB SummerFit and MB WinterFit washer fluid should be mixed together. The spray nozzles may otherwise become blocked.

Do not use distilled or de-ionized water. Otherwise, the level sensor may give a false reading.

When handling washer fluid, observe the important safety notes on service products (> page 309).

At temperatures above freezing:

- ▶ Fill the washer fluid reservoir with a mixture of water and windshield washer fluid, e.g. MB SummerFit.

Add 1 part MB SummerFit to 100 parts water.

At temperatures below freezing:

- ▶ Fill the washer fluid reservoir with a mixture of water and washer fluid, e.g. MB WinterFit.

For the correct mixing ratio refer to the information on the antifreeze reservoir.

- i** Add windshield washer fluid, e.g. MB SummerFit or MB WinterFit, to the washer fluid all year round.

Climate control system refrigerant

Important safety notes

The climate control system of your vehicle is filled with refrigerant R-134a.

The instruction label regarding the refrigerant type used can be found on the left, on the underside of the hood.

- !** Only the refrigerant R-134a and the PAG oil approved by Mercedes-Benz may be used. The approved PAG oil may not be mixed with any other PAG oil that is not approved for R-134a refrigerant. Otherwise, the climate control system may be damaged.

Service work, such as refilling with refrigerant or replacing component parts, may only be carried out by a qualified specialist workshop. All applicable regulations, as well as SAE standard J639, must be adhered to.

Always have work on the climate control system carried out at a qualified specialist workshop.

Refrigerant instruction label

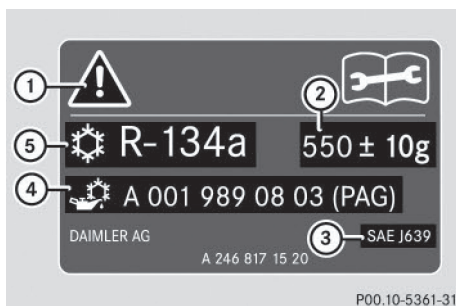

Example: refrigerant instruction label

- ① Warning symbol
- ② Refrigerant filling capacity
- ③ Applicable standards
- ④ PAG oil part number
- ⑤ Type of refrigerant

Warning symbol ① advises you about:

- Possible dangers
- Having service work carried out at a qualified specialist workshop

Filling capacities

Model	Refrigerant
Mercedes-AMG vehicles	23.6 ± 0.4 oz (670 ± 10 g)
All other models	22.9 ± 0.4 oz (650 ± 10 g)

Model	PAG oil
All models	4.2 oz (120 g)

Vehicle data

General notes

Please note that for the specified vehicle data:

- the heights specified may vary as a result of:
 - Tires
 - Load
 - Condition of the suspension
 - Optional equipment
- optional equipment reduces the maximum payload.

Dimensions and weights

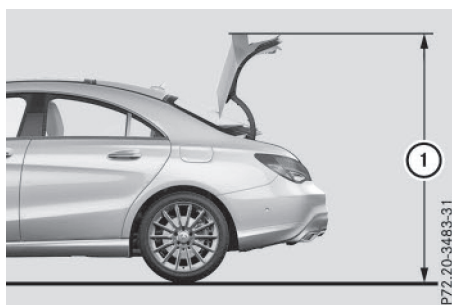

Model	① Opening height
Mercedes-AMG vehicles	68.0 in (1727 mm)
All other models	68.9 in (1749 mm)

Missing values were not available at time of going to print.

Model	
Vehicle width including exterior mirrors	80.0 in (2032 mm)
Wheelbase	106.3 in (2699 mm)
Turning radius	36.1 ft (11.0 m)

Model	Vehicle length
Mercedes-AMG vehicles	184.7 in (4691 mm)
All other models	182.7 in (4640 mm)

Model	Vehicle height
Mercedes-AMG vehicles	55.7 in (1416 mm)
All other models	56.5 in (1436 mm)

Model	Maximum roof load
Mercedes-AMG vehicles	220.5 lb (100 kg)
All other models	

Model	Maximum trunk load
Mercedes-AMG vehicles	220.5 lb (100 kg)
All other models	

