



Digitally in the vehicle

Familiarize yourself with the content of the Operator's Manual directly in the multimedia system of your vehicle (menu item "Vehicle"). Start with the quick guide, discover your vehicle's highlights or broaden your knowledge with useful tips.



Vehicle document wallet in the vehicle

Here you can find comprehensive information about operating your vehicle and about services and warranties in printed form.



Digitally on the Internet

You can find the Operator's Manual on the Mercedes-Benz homepage.



Digitally as an app

The Mercedes-Benz Guides app is available free-of-charge in familiar app stores.

E-Class



Mercedes-Benz

E-Class

Operator's Manual

Mercedes-Benz



2135840301

Order no. P213 0089 13 Part no. 213 584 03 01
Edition B-2017



Apple® iOS



Android™

Symbols

In this Operator's Manual, you will find the following symbols:

DANGER Danger due to failure to observe warning notices

Warning notices draw your attention to hazards that may endanger your health or life, or the health or life of others.

▶ Please observe the warning notices in these instructions.

ENVIRONMENTAL NOTE Environmental damage due to failure to observe environmental notes

Environmental notes include information on environmentally responsible behavior or environmentally responsible disposal.

▶ Observe environmental notes.

NOTE Damage to property due to failure to observe notes on material damage

Notes on material damage inform you of risks which may lead to your vehicle being damaged.

▶ Observe notes on material damage.

 Useful instructions or further information that could be helpful to you.

▶ Instruction

(→ page) Further information on a topic

Display Information in the multifunction display/multimedia display



Highest menu level, which is to be selected in the multimedia system



Corresponding submenus, which are to be selected in the multimedia system

*

Indicates a cause

Publication details

Internet

Further information about Mercedes-Benz vehicles and about Daimler AG can be found on the following websites:

<http://www.mbusa.com> (USA only)

<http://www.mercedes-benz.ca> (Canada only)

Editorial office

©Daimler AG: Not to be reprinted, translated or otherwise reproduced, in whole or in part, without written permission from Daimler AG.

Vehicle manufacturer

Daimler AG

Mercedesstrasse 137

70327 Stuttgart

Germany

Welcome to the world of Mercedes-Benz ...	5	Problems with your vehicle	25	Seats and stowing	81
At a glance	6	Reporting safety defects	25	Correct driver's seat position	81
Cockpit	6	Limited Warranty	26	Seats	82
Warning and indicator lamps	8	QR code for rescue card	26	Steering wheel	90
Overhead control panel	12	Data stored in the vehicle	26	Using the memory function	93
Door control panel and seat adjustment	14	Copyright	28	Stowage areas	94
Emergencies and breakdowns	16			Cup holder	103
		Occupant safety	30	Ashtray and cigarette lighter	104
Digital Operator's Manual	18	Restraint system	30	Sockets	105
Calling up the Digital Operator's Manual	18	Seat belts	33	Wireless charging of the mobile phone and connection with the exterior antenna ..	107
		Airbags	37	Installing/removing floor mats	109
General notes	19	PRE-SAFE®	44		
Protection of the environment	19	Children in the vehicle	45	Light and visibility	110
Mercedes-Benz GenuineParts	19	Pets in the vehicle	54	Exterior lighting	110
Operator's Manual	20			Interior lighting	114
Service and vehicle operation	21	Opening and closing	55	Windshield wiper and windshield washer system	115
Operating safety	22	SmartKey	55	Mirrors	118
Declaration of conformity for wireless vehicle components	23	Doors	59	Operating the sun visors	120
Diagnostics connection	24	Trunk	63		
Qualified specialist workshop	25	Roller sun blinds	69	Climate control	121
Correct use of the vehicle	25	Side windows	70	Overview of climate control systems	121
		Sliding sunroof	74	Operating the climate control system	121
		Anti-theft protection	79		

Driving and parking	126
Driving	126
DYNAMIC SELECT switch	133
Automatic transmission	134
Function of the automatic transmission	136
Manual gearshifting	137
Gearshift recommendation	137
Using kickdown	138
Refueling	138
Parking	139
Driving and driving safety systems	146

Instrument Display and on-board computer	190
Instrument Display overview	190
Overview of the buttons on the multi-function steering wheel	191
Operating the on-board computer	191
Displays in the multifunction display	193
Adjusting the instrument lighting	193
Menus and submenus	194
Head-up Display	200

Multimedia system	202
Overview and operation	202
System settings	210
Navigation	218
Telephone	220
Online and Internet functions	233
Media	239
Radio	252
Sound	258

Maintenance and care	261
ASSYST PLUS service interval display	261
Engine compartment	262
Cleaning and care	268

Breakdown assistance	276
Emergency	276
Vehicle tool kit	277
Flat tire	278
Battery (vehicle)	283
Tow starting or towing away	288
Electrical fuses	292

Wheels and tires	295
Noise or unusual handling characteristics	295
Regular checking of wheels and tires	295
Notes on snow chains	296
Tire pressure	297
Loading the vehicle	303
Tire labeling	308
Definitions for tires and loading	313
Changing a wheel	316

Technical data	324
Notes on technical data	324
Vehicle electronics	324
Vehicle identification plate, VIN and engine number	326
Operating fluids	328
Vehicle data	334

Display messages and warning/indicator lamps	336
Display messages	336
Warning and indicator lamps	379

Index **394**

Before you first drive off, read this Operator's Manual carefully and familiarize yourself with your vehicle. For your own safety and a longer vehicle life, follow the instructions and warning notices in this manual. Disregarding them may lead to damage to the vehicle or personal injury.

Vehicle damage resulting from the instructions being ignored is not covered by the Mercedes-Benz Limited Warranty.

The equipment or product designation of your vehicle may vary according to:

- Model
- Order
- National version
- Availability

Mercedes-Benz reserves the right to introduce changes in the following areas:

- Design
- Equipment
- Technical features

Therefore, the description given may vary in certain cases from the equipment in your vehicle.

The following are integral parts of the vehicle:

- Digital Operator's Manual
- Printed Operator's Manual
- Maintenance Booklet
- Equipment-dependent Supplements

Keep these documents in the vehicle at all times. If you sell the vehicle, always pass all of the documents on to the new owner.

Mercedes-Benz USA, LLC

Mercedes-Benz Canada, Inc.

A Daimler Company



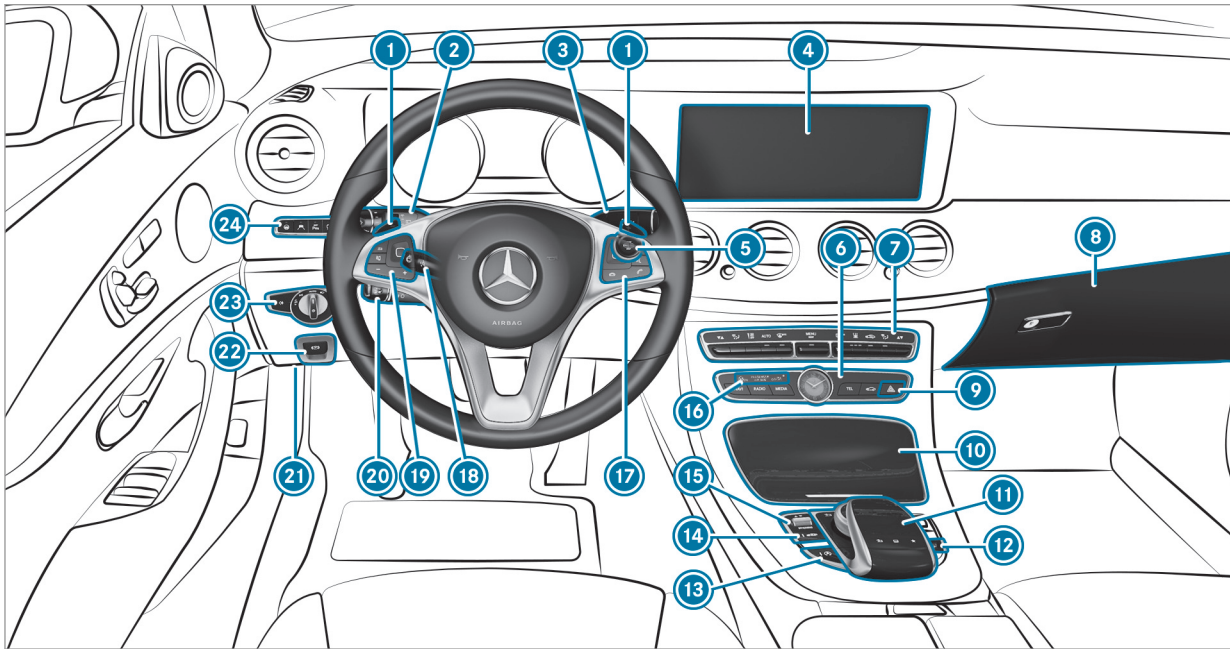



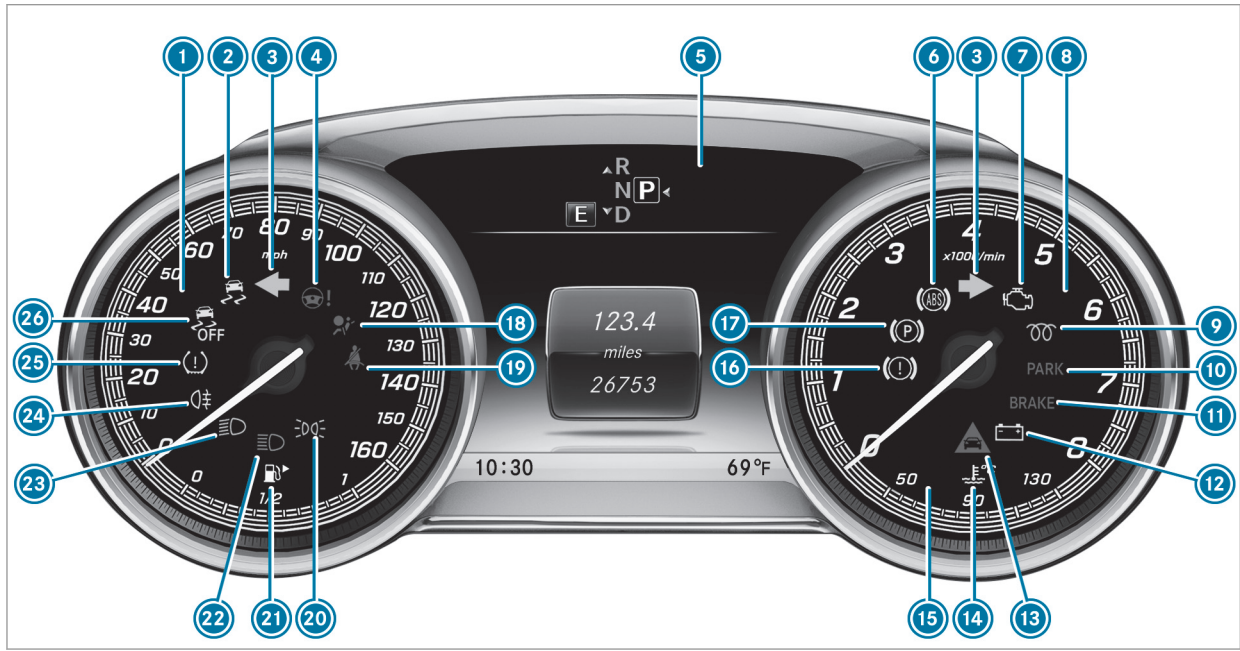





6 At a glance - Cockpit















① Steering wheel gearshift paddle	→	137	⑮ DYNAMIC SELECT switch	→	134
② Combination switch	→	111	⑯ PASSENGER AIRBAG indicator lamp	→	41 ,
③ DIRECT SELECT selector lever	→	134	⑰ Control panel for multimedia system	→	191
④ Display (multimedia system)	→	202	⑱ Adjusts the steering wheel	→	91
⑤ Start/Stop button	→	127	⑲ Control panel for on-board computer	→	191
⑥ Control panel for multimedia system	→	202	⑳ Cruise control lever	→	156
⑦ Climate control systems	→	121	㉑ To unlock the engine hood	→	262
⑧ Glove box	→	96	㉒ Electric parking brake	→	143
⑨ Hazard warning lights	→	112	㉓ Light switch	→	110
⑩ Stowage compartment	→	95	㉔ Control panel for:		
⑪ Controls for the multimedia system	→	202	Steering Pilot	→	165
⑫ Rear window roller sun blind	→	69	Active Lane Keeping Assist	→	188
⑬ ECO start/stop function	→	132	PARKTRONIC	→	171
⑭ Sets the vehicle level	→	169	360° camera	→	175
Parking Pilot	→	179	Head-up Display	→	201



Instrument display (standard)







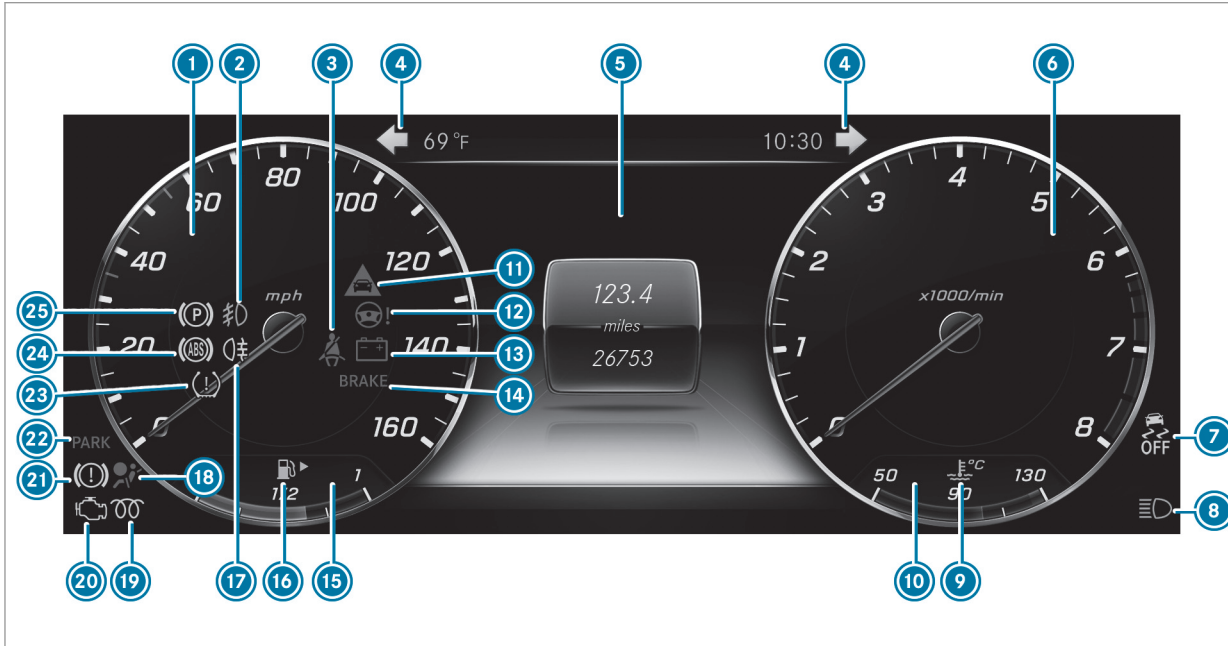





①	Speedometer	→	190
②	 ESP®		
③	  Turn signal light	→	111
④	 Steering assistance malfunction		
⑤	Multifunction display	→	193
⑥	 ABS malfunction		
⑦	 Engine diagnosis		
⑧	Tachometer	→	190
⑨	 Diesel engine: preglow		
⑩	Electric parking brake applied (red)		
	 USA only		
	 Canada only		
⑪	Brakes (red)		
	 USA only		
	 Canada only		
⑫	 Electrical malfunction		













⑬	 Distance warning		
⑭	 Coolant too hot/cold		
⑮	Coolant temperature display	→	190
⑯	 Brakes (yellow)		
⑰	 Electric parking brake (yellow)		
⑱	 Restraint system	→	31
⑲	 Seat belt is not fastened		
⑳	 Parking lamps	→	110
㉑	Fuel level display		
	 Fuel reserve with fuel filler cap location indicator		
㉒	 High beam	→	111
㉓	 Low beam	→	110
㉔	 Rear fog light	→	111
㉕	 Tire pressure monitoring system		
㉖	 ESP® OFF		

10 At a glance – Warning and indicator lamps







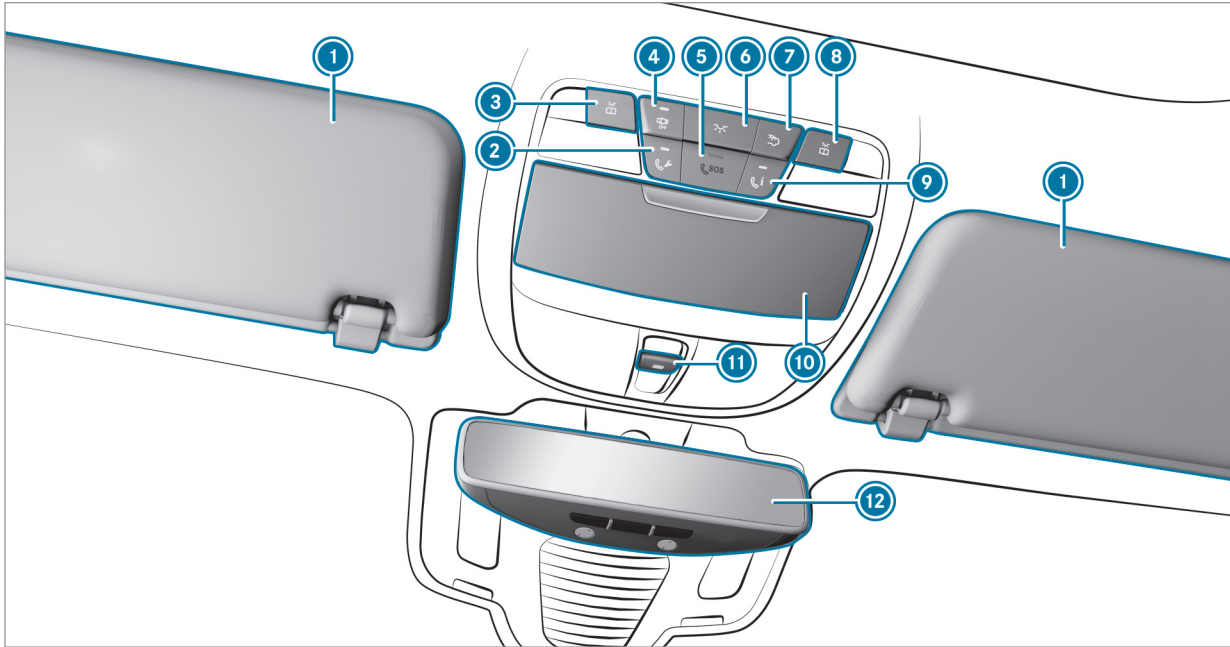

Instrument display in the widescreen cockpit

①	Speedometer	→	190
②	Fog light		
③	 Seat belt is not fastened		
④	  Turn signal light	→	111
⑤	Multifunction display	→	193
⑥	Tachometer	→	190
⑦	 ESP® OFF		
	 ESP®		
⑧	 High beam	→	111
	 Low beam	→	110
	 Parking lamps	→	110
⑨	 Coolant too hot/cold		
⑩	Coolant temperature display	→	190
⑪	 Distance warning		
⑫	 Steering assistance malfunction		
⑬	 Electrical malfunction		

⑭	Brakes (red)		
	 USA only		
	 Canada only		
⑮	Fuel level display		
⑯	 Fuel reserve with fuel filler cap location indicator		
⑰	 Rear fog light	→	111
⑱	 Restraint system	→	31
⑲	 Diesel engine: preglow		
⑳	 Engine diagnosis		
㉑	 Brakes (yellow)		
㉒	Electric parking brake applied (red)		
	 USA only		
	 Canada only		
㉓	 Tire pressure monitoring system		
㉔	 ABS malfunction		
㉕	 Electric parking brake (yellow)		







12 At a glance – Overhead control panel

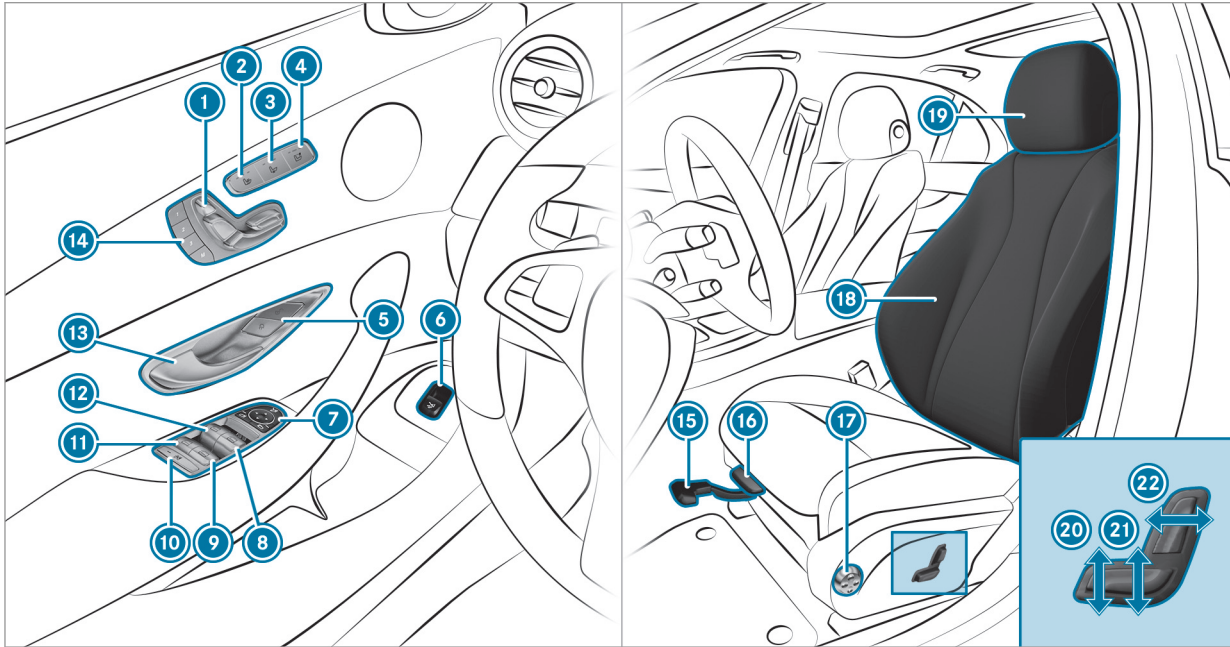

① Sun visors	→	120	⑧  Switches the right-hand reading lamp on/off	→	114
② Roadside Assistance call button (mbrace®)	→	232	⑨ MB Info call button (mbrace®)	→	232
③  Switches the left-hand reading lamp on/off	→	114	⑩ Eyeglasses box	→	96
④  Switches the automatic lighting control on/off	→	114	⑪  Opens/closes the panoramic sliding sunroof	→	74
⑤ SOS button (mbrace®)	→	231	Opens/closes the roller sun blinds	→	74
⑥  Switches the front interior lighting on/off	→	114	⑫ Inside mirror	→	119
⑦  Switches the rear interior lighting on/off	→	114			

14 At a glance – Door control panel and seat adjustment



①	Adjusts the seats electrically	→	84	⑫	 Opens/closes the left side window	→	70
②	Switches the seat heater on/off	→	89	⑬	Opens the door	→	59
③	Switches the seat ventilation on/off	→	90	⑭	Sets the memory function	→	93
④	Adjusts the front passenger seat from the driver's seat			⑮	Sets the seat fore-and-aft adjustment	→	84
⑤	  Locks/unlocks the vehicle	→	59	⑯	Adjusts the seat cushion length	→	84
⑥	Opens/closes the trunk lid	→	63	⑰	Adjusts the 4-way lumbar support	→	85
⑦	Adjusts and folds the outside mirrors out/in electrically	→	118	⑱	Seat adjustment using the multimedia system	→	87
⑧	 Opens/closes the right side window	→	70	⑲	Adjusts the head restraints	→	85
⑨	 Opens/closes the rear right side window	→	70	⑳	Adjusts the seat cushion inclination	→	84
⑩	Child safety lock for the rear side windows	→	53	㉑	Adjusts the seat height	→	84
⑪	 Opens/closes the rear left side window	→	70	㉒	Adjusts the seat backrest inclination	→	84

16 At a glance – Emergencies and breakdowns

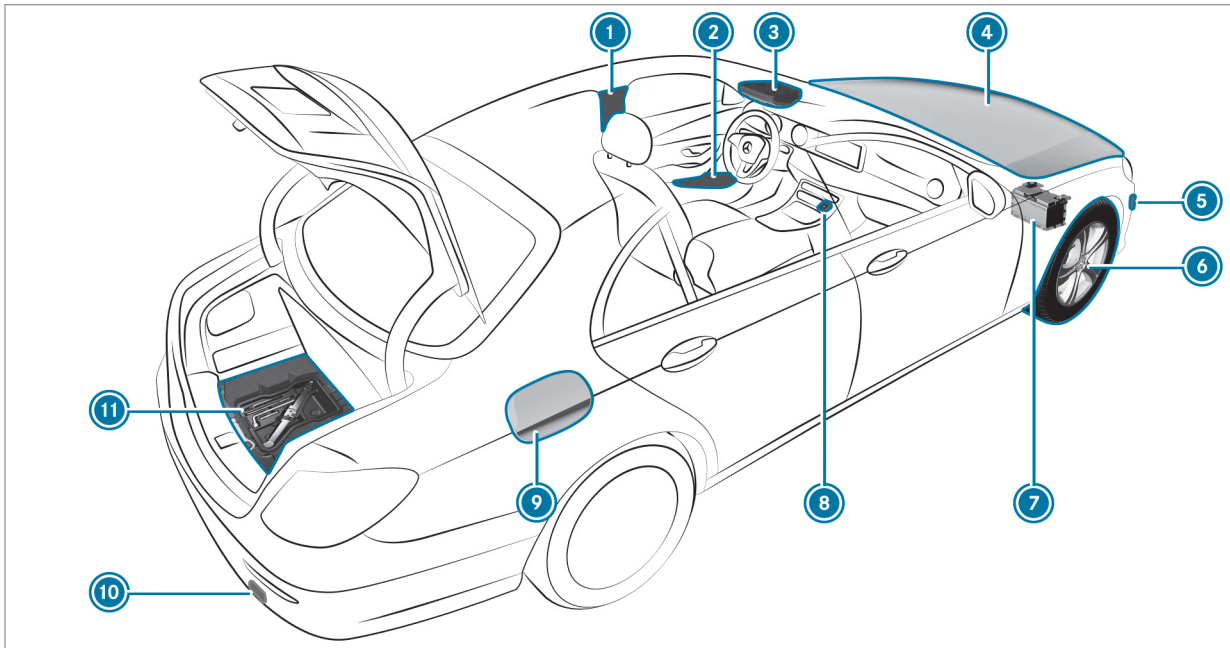

What to do in the event of an accident			⑦ Starting assistance	→	285
① QR code for accessing the rescue card	→	26	⑧ Hazard warning lights	→	112
② Safety vests	→	276	⑨ Fuel filler flap with instruction labels for tire pressure, fuel type and QR code for accessing the rescue card	→	138
③ Button for the SOS emergency call system and Roadside Assistance	→	230	⑩ Tow-starting and towing away	→	288
④ Checking and adding operating fluids	→	328	⑪ Vehicle tool kit	→	277
⑤ Tow-starting and towing away	→	288	TIREFIT KIT	→	279
⑥ Flat tire	→	278			

Calling up the Digital Operator's Manual

Multimedia system:

→ Vehicle → ⓘ Operator's Manual



▶ Select a menu item.

In addition, you can also call up the Operator's Manual within a main function (e.g. via [Info on Phone](#)).

The Digital Operator's Manual describes the function and operation of:

- The vehicle
- The multimedia system

For safety reasons, the Digital Operator's Manual is deactivated while driving.

The Digital Operator's Manual contains the following menu items:

- **Search:** allows you to search precisely for keywords.
- **Quick start:** provides you with important information so that you can start using your vehicle immediately.
- **Tips:** provides tips on how to use your vehicle in certain situations.
- **Highlights:** shows you vehicle highlights using pictures and animations.
- **Messages:** provides you with further information about the messages in the instrument cluster.
- **Bookmarks:** provides you with a list of all the bookmarks you have stored yourself.

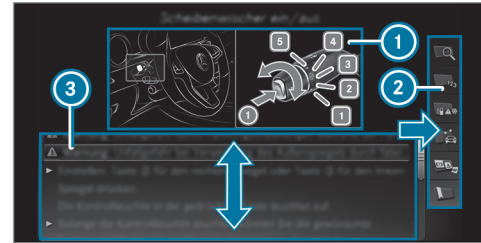

- ① Picture
- ② Menu
- ③ Navigation window

Some sections of the Digital Operator's Manual, such as warning notes can be made visible by highlighting and pressing them.

- ⓘ The Operator's Manual can also be found in the Mercedes-Benz Guides App in all common App Stores.

Protection of the environment

! ENVIRONMENTAL NOTE Environmental damage due to operating conditions and personal driving style

The pollutant emission of your vehicle is directly related to the way you operate your vehicle.

You can help to protect the environment by operating your vehicle in an environmentally-responsible manner. Please observe the following recommendations on operating conditions and personal driving style.

Operating conditions:

- ▶ Make sure that the tire pressure is correct.
- ▶ Do not carry any unnecessary weight (e.g. roof luggage racks once you no longer need them).
- ▶ Adhere to the service intervals. A regularly serviced vehicle will contribute to environmental protection.

- ▶ Always have service work carried out at a qualified specialist workshop.

Personal driving style:

- ▶ Do not depress the accelerator pedal when starting the engine.
- ▶ Do not warm up the engine while the vehicle is stationary.
- ▶ Drive carefully and maintain a suitable distance from the vehicle in front.
- ▶ Avoid frequent, sudden acceleration and braking.
- ▶ Change gear in good time and use each gear only up to $\frac{2}{3}$ of its maximum engine speed.
- ▶ Switch off the engine in stationary traffic.
- ▶ Keep an eye on the vehicle's fuel consumption.

Environmental issues and recommendations:

It is recommended that you re-use or recycle materials first instead of just disposing of them.

The relevant environmental regulations and guidelines serve to protect the environment and must be strictly observed.

Mercedes-Benz GenuineParts

! ENVIRONMENTAL NOTE Environmental damage caused by the non-use of reconditioned components.

Daimler AG offers recycled reconditioned components and parts with the same quality as new parts. The same entitlement from the limited warranty is valid as for new parts.

- ▶ Use recycled reconditioned components and parts from Daimler AG.

! **NOTE** Impairment of the operating efficiency of the restraint systems from installing accessories or from repairs or welding

Airbags, Emergency Tensioning Devices, as well as control units and sensors for the restraint systems, may be installed in the following areas of your vehicle:

- Doors
- Door pillars
- Door sills
- Seats
- Cockpit
- Instrument cluster
- Center console

- ▶ Do not install accessories such as audio systems in these areas.
- ▶ Do not carry out repairs or welding.
- ▶ Have accessories retrofitted at a qualified specialist workshop.

You could jeopardize the operating safety of your vehicle if you use parts, tires and wheels as well as accessories relevant to safety which have not been approved by Mercedes-Benz. This could lead to malfunctions in safety-relevant systems, e.g. the brake system. Only use Mercedes-Benz GenuineParts or parts of equal quality. Only use tires, wheels and accessories that have been specifically approved for your vehicle model.

Mercedes-Benz GenuineParts are subject to strict quality control. Each part has been specially developed, manufactured or selected for Mercedes-Benz vehicles and fine-tuned for them. Therefore, only Mercedes-Benz GenuineParts should be used.

More than 300,000 different Mercedes-Benz GenuineParts are available for Mercedes-Benz models.

All Mercedes-Benz service centers maintain a supply of Mercedes-Benz GenuineParts for necessary service and repair work. In addition, strategically located parts-delivery centers provide for quick and reliable parts service.

Always specify the vehicle identification number (VIN) when ordering Mercedes-Benz GenuineParts (→ page 326).

Operator's Manual

This Operator's Manual describes all models and all standard and optional equipment available for your vehicle at the time of this Operator's Manual going to press. Country-specific differences are possible. Note that your vehicle may not be equipped with all features described. This is also the case for systems and functions relevant to safety. Therefore, the equipment on your vehicle may differ from that in the descriptions and illustrations.

The original purchase contract documentation for your vehicle contains a list of all of the systems in your vehicle.

Should you have any questions concerning equipment and operation, please consult an authorized Mercedes-Benz service center.

The Operator's Manual and maintenance booklet are important documents and should be kept in the vehicle.

Service and vehicle operation

Vehicle operation outside the USA or Canada

When you are abroad with your vehicle, observe the following points:

- Service points or replacement parts may not be available immediately.
- Unleaded fuel may not be available for vehicles with a catalytic converter. Leaded fuel may cause damage to the catalytic converter.
- The fuel may have an extremely low octane number. Unsuitable fuel can cause engine damage.

Some Mercedes-Benz models are available in Europe through our European Delivery Program. For more information, please consult an authorized Mercedes-Benz service center, or write to one of the following address:

In the USA:

Mercedes-Benz USA, LLC
European Delivery Department
One Mercedes Drive
Montvale, NJ 07645-0350

In Canada:

Mercedes-Benz Canada, Inc.
European Delivery Department
98 Vanderhoof Avenue
Toronto, Ontario M4G 4C9

Maintenance

The maintenance and warranty information booklet describes all the necessary maintenance work which should be carried out at regular intervals.

Always bring the maintenance and warranty information booklet with you when bringing the vehicle to a Mercedes-Benz service center. The customer service advisor will record every service for you in the maintenance and warranty information booklet.

Roadside Assistance

The Mercedes-Benz Roadside Assistance Program offers technical help in the case of a breakdown. Your calls to the toll-free Roadside

Assistance Hotline are answered by our agents 24 hours a day, 365 days a year.

1-800-FOR-MERCEdes (1-800-367-6372) (USA)
1-800-387-0100 (Canada)

You can find further information in the Mercedes-Benz Roadside Assistance Program brochure (USA) or the "Roadside Assistance" section in the maintenance and warranty information booklet (Canada). You will find both in the vehicle document wallet.

Change of address or change of ownership

In the event of a change of address, please send us the "Notification of address change" in the Service and Guarantee booklet or simply call the Mercedes-Benz Customer Assistance Center (USA) on the hotline number 1-800-FOR-MERCEdes (1-800-367-6372) or Customer Service (Canada) on 1-800-387-0100. We can then reach you in a timely fashion, if necessary.

If you sell your Mercedes, please leave the entire literature in the vehicle so that it is available to

the next owner. If you have purchased a used car, please send us the "Notice of Purchase of Used Car" in the Service and Guarantee booklet or simply call the Mercedes-Benz Customer Assistance Center (USA) on the hotline number 1-800-FOR-MERCEdes (1-800-367-6372) or Customer Service (Canada) on 1-800-387-0100.

Important notice for California retail buyers and lessees of Mercedes-Benz automobiles

Under California law you may be entitled to a replacement of your vehicle or a refund of the purchase price or lease price, if after a reasonable number of repair attempts Mercedes-Benz USA, LLC and/or its authorized repair or service facilities fail to fix one or more substantial defects or malfunctions in the vehicle that are covered by its express warranty.

During a period of 18 months from original delivery of the vehicle or a kilometer/mileage reading of 18,000 miles (29,000 km), whichever occurs first, vehicle repair is presumed for a retail buyer or lessee if one or more of the following occurs:

- (1) the serious defect or damage can result in deadly or serious injury to the vehicle occupants while driving AND this defect has already been repaired at least twice AND Mercedes-Benz, LLC has been informed in writing of the necessity of a repair.
- (2) the defect or damage, though less serious than (1) above, has already been repaired at least four times AND Mercedes-Benz has been informed in writing of the necessity of a repair.
- (3) the vehicle cannot be used for longer than 30 calendar days because of repair work resulting from this or other serious defects or damage.

Please send your written notice to:
Mercedes-Benz USA, LLC
Customer Assistance Center

3 Mercedes Drive
Montvale, NJ 07645-0350

Operating safety

⚠ WARNING Risk of accident due to malfunctions or system failures

If you do not have the prescribed service/maintenance work or any required repairs carried out, this could result in malfunctions or system failures.

► Always have the prescribed service/maintenance work as well any required repairs carried out at a qualified specialist workshop.

⚠ WARNING Risk of fire due to flammable materials on hot parts of the exhaust system

Flammable material such as leaves, grass or twigs may ignite if they come into contact with hot parts of the exhaust system.

- ▶ When driving on unpaved roads or off-road, regularly check the vehicle underside.
- ▶ Remove trapped plants or other flammable material, in particular.
- ▶ If there is damage, consult a qualified specialist workshop immediately.

⚠ WARNING Risk of accident or injury due to incorrect modifications on electronic component parts

Modification to electronic components, their software or wiring could impair their function and/or the function of other networked component parts. In particular, systems relevant to safety could also be affected.

As a result, these may no longer function properly and/or jeopardize the operating safety of the vehicle.

- ▶ Never tamper with the wiring and electronic component parts or their software.

- ▶ You should have all work on electrical and electronic components carried out at a qualified specialist workshop.

! **NOTE** Damage to the vehicle

Damage to the vehicle may occur in the following cases:

- The vehicle becomes grounded, e.g. on a high curb or an unpaved road.
- The vehicle is driven too fast over an obstacle, e.g. a curb or a pothole in the road.
- A heavy object strikes the underbody or parts of the chassis.

In situations like this, the body, the underbody, chassis parts, wheels or tires could be damaged without the damage being visible. Components damaged in this way can unexpectedly fail or, in the case of an accident, no longer withstand the strain they are designed to.

If the underbody paneling is damaged, flammable materials such as leaves, grass or twigs can gather between the underbody and the underbody paneling. If these materials come into contact with hot parts on the exhaust system, they may catch fire.

- ▶ Have the vehicle checked and repaired immediately at a qualified specialist workshop.

or

- ▶ If driving safety is impaired while continuing your journey, pull over and stop the vehicle immediately, paying attention to road and traffic conditions, and contact a qualified specialist workshop.

Declaration of conformity for wireless vehicle components

USA: "The wireless devices of this vehicle comply with Part 15 of the FCC Rules. Operation is subject to the following two conditions: 1) These devices may not cause harmful interference, and 2) These devices must accept any interference

received, including interference that may cause undesired operation. Changes or modifications not expressly approved by the party responsible for compliance could void the user's authority to operate the equipment."

Canada: "The wireless devices of this vehicle comply with Industry Canada license-exempt RSS standard(s). Operation is subject to the following two conditions: (1) These devices may not cause interference, and (2) These devices must accept any interference, including interference that may cause undesired operation of the device."

Diagnosics connection

The diagnosics connection is only intended for the connection of diagnostic devices at a qualified specialist workshop.

⚠ WARNING Risk of accident due to connecting devices to the diagnostics connection

If you connect equipment to a diagnostics connection in the vehicle, it may affect the operation of vehicle systems.

As a result, the operating safety of the vehicle could be affected.

- ▶ Only connect equipment to a diagnostics connection in the vehicle which is approved for your vehicle by Mercedes-Benz.

⚠ WARNING Risk of accident due to objects in the driver's footwell

Objects in the driver's footwell may impede pedal travel or block a depressed pedal.

This jeopardizes the operating and road safety of the vehicle.

- ▶ Stow all objects in the vehicle securely so that they cannot get into the driver's footwell.

- ▶ Always install the floor mats securely and as prescribed in order to ensure that there is always sufficient room for the pedals.
- ▶ Do not use loose floor mats and do not place floor mats on top of one another.

! NOTE Battery discharging from using devices connected to the diagnostics connection

Using devices at the diagnostics connection drains the battery.

- ▶ Check the charge level of the battery.
- ▶ If the charge level is low, charge the battery, e.g. by driving a considerable distance.

Connecting equipment to the diagnostics connection can lead to emissions monitoring information being reset, for example. This may lead to the vehicle failing to meet the requirements of the next emissions inspection during the main inspection.

Qualified specialist workshop

An authorized Mercedes-Benz service center is a qualified specialist workshop. It has the necessary specialist knowledge, tools and qualifications to correctly carry out the work required on your vehicle. This particularly applies to work relevant to safety.

For the following, always have your vehicle checked at an authorized Mercedes-Benz service center:

- Work relevant to safety
- Service and maintenance work
- Repair work
- Modifications, installations and conversions
- Work on electronic component parts

Correct use of the vehicle

If you remove any warning stickers, you or others could fail to recognize certain dangers. Leave warning stickers in position.

Observe the following information when driving your vehicle:

- the safety notes in this manual
- the vehicle technical data
- traffic rules and regulations
- laws and safety standards pertaining to motor vehicles

Problems with your vehicle

If you should experience a problem with your vehicle, particularly one that you believe may affect its safe operation, we urge you to contact an authorized Mercedes-Benz service center immediately to have the problem diagnosed and rectified. If the problem is not resolved to your satisfaction, please discuss the problem again with the authorized Mercedes-Benz service center or, if necessary, contact us at one of the following addresses.

In the USA:

Customer Assistance Center
Mercedes-Benz USA, LLC

3 Mercedes Drive
Montvale, NJ 07645-0350

In Canada:

Customer Relations Department
Mercedes-Benz Canada, Inc.
98 Vanderhoof Avenue
Toronto, Ontario M4G 4C9

Reporting safety defects

USA only:

The following text is published as required of manufacturers under Title 49, Code of U.S. Federal Regulations, Part 575 pursuant to the "National Traffic and Motor Vehicle Safety Act of 1966".

If you believe that your vehicle has a defect which could cause a crash or could cause injury or death, you should immediately inform the National Highway Traffic Safety Administration (NHTSA) in addition to notifying Mercedes-Benz USA, LLC.

If NHTSA receives similar complaints, it may open an investigation, and if it finds that a safety defect exists in a group of vehicles, it may order a recall and remedy campaign. However, NHTSA cannot become involved in individual problems between you, your dealer, or Mercedes-Benz USA, LLC.

To contact NHTSA, you may call the Vehicle Safety Hotline toll-free at 1-888-327-4236 (TTY: 1-800-424-9153); go to <http://www.safercar.gov> or write to: Administrator, NHTSA, 400 Seventh Street, SW., Washington, DC 20590, USA.

You can find more information on vehicle safety under: <http://www.safercar.gov>

Limited Warranty

! **NOTE** Damage to the vehicle arising from culpable violation of these operating instructions.

Damage to the vehicle can arise from culpable violation of these operating instructions.

This damage is not covered either by the Mercedes-Benz Limited Warranty or by the New Vehicle or Used Vehicle Warranty.

▶ Follow the instructions in this manual on proper operation of your vehicle as well as on possible vehicle damage.

QR code for rescue card

The QR code is secured in the fuel filler flap and on the opposite side on the B-pillar. In the event of an accident, rescue services can use the QR code to quickly find the appropriate rescue card for your vehicle. The current rescue card contains the most important information about your vehicle in a compact form, e.g. the routing of the electric lines.

You can find more information under http://portal.aftersales.i.daimler.com/public/content/asportal/en/communication/informationen_fuer/QRCode.html.

Data stored in the vehicle

Data Recording

A wide range of electronic components in your vehicle contain data memories.

These data memories temporarily or permanently store technical information about:

- The vehicle's operating state
- Events
- Malfunctions

In general, the technical information documents the state of a component part, a module, a system or the surroundings.

This includes, for example:

- Operating conditions of system components, e.g. fluid levels.
- The vehicle's status messages and those of its individual components, e.g. number of wheel revolutions/speed, deceleration, lateral acceleration, accelerator pedal position.
- Malfunctions and defects in important system components, e.g. lights, brakes.

- Vehicle reactions and operating conditions in special driving situations, e.g. airbag deployment, intervention of stability control systems.
- Ambient conditions, e.g. outside temperature.

This data is of an exclusively technical nature and can be used to:

- Assist in detecting and rectifying malfunctions and defects.
- Analyze vehicle functions, e.g. after an accident.
- Optimize vehicle functions.

The data cannot be used to trace the vehicle's movements.

When your vehicle is serviced, technical information can be read from the event data memory and fault data memory.

Services include, for example:

- Repair services
- Service processes
- Warranty events

The vehicle is read out by employees of the service network (including the manufacturer) using special diagnostic devices. You can obtain more information there, if required.

After a malfunction has been rectified, the information is deleted from the fault memory or is continually overwritten.

When operating the vehicle, situations are conceivable in which this technical data, in connection with other information (if necessary, after consultation with an authorized expert), could be traced to a person.

Examples include:

- Accident reports
- Damage to the vehicle
- Witness statements

Further additional functions that have been contractually agreed upon with the customer allow certain vehicle data to be conveyed by the vehicle as well. The additional functions include, for example, vehicle location in case of an emergency.

COMAND/mbrace

If the vehicle is equipped with COMAND or mbrace, additional data about the vehicle's operation, the use of the vehicle in certain situations, and the location of the vehicle may be compiled through COMAND or the mbrace system.

For additional information please refer to the chapter Multimediasystem and/or the mbrace Terms and Conditions.

Event Data Recorders

This vehicle is equipped with an event data recorder (EDR). The main purpose of an EDR is to record, in certain crash or near crash-like situations, such as an air bag deployment or hitting a road obstacle, data that will assist in understanding how a vehicle's systems performed. The EDR is designed to record data related to vehicle dynamics and safety systems for a short period of time, typically 30 seconds or less.

The EDR in this vehicle is designed to record such data as:

- How various systems in your vehicle were operating;

- Whether or not the driver and passenger safety belts were buckled/fastened;
- How far (if at all) the driver was depressing the accelerator and/or brake pedal; and,
- How fast the vehicle was traveling.

These data can help provide a better understanding of the circumstances in which crashes and injuries occur. NOTE: EDR data are recorded by your vehicle only if a non-trivial crash situation occurs; no data are recorded by the EDR under normal driving conditions and no personal data (e.g., name, gender, age, and crash location) are recorded. However, other parties, such as law enforcement could combine the EDR data with the type of personally identifying data routinely acquired during a crash investigation.

Access to the vehicle and/or the EDR is needed to read data that is recorded by an EDR, and special equipment is required. In addition to the vehicle manufacturer, other parties that have the special equipment, such as law enforcement, can read the information by accessing the vehicle or the EDR.

EDR data may be used in civil and criminal matters as a tool in accident reconstruction, accident claims and vehicle safety. Since the Crash Data Retrieval CDR tool that is used to extract data from the EDR is commercially available, Mercedes-Benz USA, LLC ("MBUSA") expressly disclaims any and all liability arising from the extraction of this information by unauthorized Mercedes-Benz personnel.

MBUSA will not share EDR data with others without the consent of the vehicle owners or, if the vehicle is leased, without the consent of the lessee. Exceptions to this representation include responses to subpoenas by law enforcement; by federal, state or local government; in connection with or arising out of litigation involving MBUSA or its subsidiaries and affiliates; or, as required by law.

Warning: The EDR is a component of the Restraint System Module. Tampering with, altering, modifying or removing the EDR component may result in a malfunction of the Restraint System Module and other systems.

State laws or regulations regarding EDRs that conflict with federal regulation are pre\empted.

This means that in the event of such conflict, the federal regulation governs. As of February 2013, 13 states have enacted laws relating to EDRs.

Copyright

Information on licenses for free and open-source software

Information on licenses for free and open-source software used in your vehicle and its electronic components is available online at:

<http://www.mercedes-benz.com/opensource>

Registered trademarks:

- Bluetooth® is a registered trademark of Bluetooth SIG Inc.
- DTS™ is a registered trademark of DTS, Inc.
- Dolby® and MLP™ are registered trademarks of DOLBY Laboratories.
- BabySmart™, ESP® and PRE-SAFE® are registered trademarks of Daimler AG.
- HomeLink® is a registered trademark of Johnson Controls.

- iPod® and iTunes® are registered trademarks of Apple Inc.
- Burmester® is a registered trademark of Burmester Audiosysteme GmbH.
- Microsoft® and Windows Media® are registered trademarks of Microsoft Corporation.
- SIRIUS® is a registered trademark of Sirius XM Radio Inc.
- HD Radio™ is a registered trademark of iBiquity Digital Corporation.
- Gracenote® is a registered trademark of Gracenote, Inc.
- ZAGATSurvey® and related brands are registered trademarks of ZagatSurvey, LLC.

Restraint system

Protection by the restraint system

The restraint system includes the following:

- Seat belt system
- Airbags
- Child restraint system
- Child seat securing system

In the event of an accident, the restraint system can:

- Reduce the risk of vehicle occupants coming into contact with parts of the vehicle interior.
- Reduce the forces to which the vehicle occupants are subjected.

A seat belt can only provide the best level of protection if it is worn correctly. Depending on the detected accident situation, Emergency Tensioning Devices and/or airbags supplement the protection offered by a correctly worn seat belt. Emergency Tensioning Devices and/or airbags are not deployed in every accident.

So that the restraint system can provide protection, each vehicle occupant must:

- With the seat belt fastened correctly
- In an almost upright position with their back against the seat backrest
- Sit with their feet resting on the floor, if possible.
- Always be secured in an additional restraint system suitable for Mercedes-Benz vehicles if they are under 5 ft (1.50 m) tall.

However, no system available today can completely eliminate injuries and fatalities in every accident situation. In particular, the seat belt and airbag generally do not protect against objects penetrating the vehicle from the outside. A risk of injury caused by the airbag deploying can also not be completely ruled out.

Reduced restraint system protection

⚠ WARNING Risk of injury or death from modifications to the restraint system

Modifications to the restraint system may cause it to no longer work as intended.

The restraint system may then not protect the vehicle occupants as intended by failing in an accident or triggering unexpectedly, for example

- ▶ Never alter the parts of the restraint system.
- ▶ Never tamper with the wiring or any electronic component parts or their software.

If it is necessary to modify the vehicle to accommodate a person with disabilities, contact a qualified specialist workshop. Mercedes-Benz recommends that you only use seat belts which have been approved specifically for your vehicle by Mercedes-Benz.



- Contact a Mercedes-Benz service center for details.

- **USA only:** For details, contact our Customer Assistance Center on 1-800-FOR-MERcedes (1-800-367-6372).

Restraint system functionality

When the ignition is switched on, a system self-test is performed, during which the  restraint system warning lamp lights up. It goes out no later than a few seconds after the vehicle is started. The components of the restraint system are then functional.

Restraint system malfunction

- The  restraint system warning lamp does not light up when the ignition is switched on.
- The  restraint system warning lamp lights up continuously or repeatedly during a journey.

⚠ WARNING Risk of injury or fatal injury due to a malfunction in the restraint system

If the restraint system is malfunctioning, restraint system components may be triggered unintentionally or might not be triggered at all in the event of an accident. This may affect the Emergency Tensioning Device or airbag, for example.

- ▶ Have the restraint system checked and repaired immediately at a qualified specialist workshop.

Function of the restraint system in an accident

How the restraint system works is determined by the severity of the impact detected and the type of accident anticipated:

- Frontal impact
- Rear impact
- Side impact
- Rollover

The activation thresholds for the components of the restraint system are determined based on the evaluation of the sensor values measured at various points in the vehicle. This process is preemptive in nature. The triggering/deployment of the components of the restraint system should take place in good time at the start of the collision.

Factors which can only be seen and measured after a collision has occurred cannot play a decisive role in air bag deployment, nor do they provide an indication of air bag deployment.

The vehicle may be deformed significantly without an air bag being deployed. This is the case if only parts which are relatively easily deformed are affected and the rate of vehicle deceleration is not high. Conversely, an air bag may be deployed even though the vehicle suffers only minor deformation. If very rigid vehicle parts such as longitudinal members are hit, for example, this may result in sufficiently high levels of vehicle deceleration.

The components of the restraint system can be activated or deployed independently of each other:

Component	Detected deployment situation
Emergency Tensioning Devices	Frontal impact, rear impact, side impact, rollover
Driver's air bag, front passenger air bag, knee air bag	Frontal impact
Side air bag	Side impact
Window air bag	Side impact, rollover, frontal impact
Belt air bag	Frontal impact
PRE-SAFE® Impulse Side	Side impact

The front passenger air bag can only be deployed in an accident if the PASSENGER AIR BAG OFF indicator lamp is off. If the front

passenger seat is occupied, make sure, both before and during the journey, that the status of the front passenger air bag is correct (→ page 41) .

⚠ WARNING Risk of burns from hot airbag components

The airbag parts are hot after an airbag has been deployed.

- ▶ Do not touch the airbag parts.
- ▶ Have a deployed airbag replaced at a qualified specialist workshop as soon as possible.

i Mercedes-Benz recommends that you have the vehicle towed to a qualified specialist workshop following an accident. This is particularly important when an Emergency Tensioning Device was triggered or an air bag was deployed.

If the Emergency Tensioning Devices are triggered or an air bag is deployed, you will hear a bang, and a small amount of powder may also be released:

- The bang will not generally affect your hearing.
- In general, the powder released is not hazardous to health but may cause short-term breathing difficulties to persons suffering from asthma or other pulmonary conditions. Provided it is safe to do so, leave the vehicle immediately or open the window in order to prevent breathing difficulties.

Air bags and pyrotechnic Emergency Tensioning Devices contain perchlorate material, which may require special handling or environmental protection measures. National guidelines regarding waste disposal must be observed. In California, see www.dtsc.ca.gov/HazardousWaste/Perchlorate/index.cfm.

Seat belts

Protection provided by the seat belt

Always fasten your seat belt correctly before starting a journey. A seat belt can only provide the best level of protection if it is worn correctly.

⚠ WARNING Risk of injury or death due to incorrectly fastened seat belt

If the seat belt is not worn correctly, it cannot perform its intended protective function. In addition, an incorrectly fastened seat belt can also cause injuries, for example, in the event of an accident or when braking or changing direction suddenly.

▶ Always ensure that all vehicle occupants have their seat belts fastened correctly and are sitting properly.

- The seat belt must:
 - Not be twisted and must fit tightly and snugly across your body.

- Be routed across the center of your shoulder and as low down across your hips as possible.
- The shoulder section of the seat belt should not touch your neck nor be routed under your arm or behind your back.
- Avoid wearing bulky clothing, e.g. a winter coat.
- Push the lap belt down as far as possible across your hips and pull tight with the shoulder section of the belt. Never route the lap belt across your abdomen.
- Never route the seat belt across sharp, pointed, abrasive or fragile objects.
- Only one person should use each seat belt at any one time. Never allow babies and children to travel sitting on the lap of another vehicle occupant.
- Never secure objects with a seat belt if the seat belt is also being used by one of the vehicle's occupants. Always observe the instructions for loading the vehicle when securing objects, luggage or loads (→ page 94).

All seat belts in the vehicle except the driver's seat belt are equipped with a child seat safety feature. You can find further information under "Child seat safety feature" (→ page 47).

If children are traveling in the vehicle, be sure to observe the instructions and safety notes on "Children in the vehicle" (→ page 45).

Reduced protection

⚠ WARNING Risk of injury due to an incorrect seat position

The seat belt does not offer the intended level of protection if you have not moved the seat backrest to an almost vertical position. When braking or in the event of an accident, you could slide underneath the seat belt and sustain abdomen or neck injuries, for example. This poses an increased risk of injury or even fatal injury.

▶ Adjust the seat correctly before starting the journey.

- ▶ Always ensure that the seat backrest is in an almost vertical position and that the shoulder section of your seat belt is routed across the center of your shoulder.

⚠ WARNING Risk of injury or death when additional restraint systems are not used for persons with a smaller build

Persons under 5 ft (1.50 m) tall cannot wear the seat belt correctly without a suitable additional restraint system.

If the seat belt is not worn correctly, it cannot perform its intended protective function. In addition, an incorrectly fastened seat belt can also cause injuries, for example, in the event of an accident or when braking or changing direction suddenly.

- ▶ Always secure persons under 5 ft (1.50 m) tall in a suitable restraint system.

⚠ WARNING Risk of injury or death due to blocked seat belt buckle or seat belt anchorage

Objects next to the front seat that block the seat belt buckle or the moving seat belt anchorage on the front seat impair the function of the Emergency Tensioning Devices.

The Emergency Tensioning Devices can, then, not function as intended and the seat belt can no longer provide the intended protection.

- ▶ Before starting the journey, make sure that there are no objects around the seat belt buckle or between the front seat and door.

⚠ WARNING Risk of injury or death due to damaged or modified seat belts

Seat belts cannot provide protection in the following situations:

- If the seat belts are damaged, modified, extremely dirty, bleached or dyed

- If the seat belt buckle is damaged or extremely dirty
- If the Emergency Tensioning Devices, seat belt anchorages or seat belt retractors have been modified

Seat belts may be damaged in an accident, although the damage may not be visible, e.g. due to splinters of glass.

Modified or damaged seat belts may tear or fail, e.g. in an accident.

Modified Emergency Tensioning Devices could accidentally trigger or fail to function as intended.

- ▶ Never modify the seat belts, Emergency Tensioning Devices, seat belt anchorages or seat belt retractors.
- ▶ Make sure that the seat belts are undamaged, not worn and clean.
- ▶ Always have the seat belts checked immediately after an accident at a qualified specialist workshop.

Only use seat belts that have been approved for your vehicle by Mercedes-Benz.

⚠ WARNING Risk of injury or death from deployed pyrotechnic Emergency Tensioning Devices

Pyrotechnic Emergency Tensioning Devices that have been deployed are no longer operational and are unable to perform their intended protective function.

- ▶ Therefore, have deployed pyrotechnic Emergency Tensioning Devices immediately replaced at a qualified specialist workshop.

Mercedes-Benz recommends that you have the vehicle towed to a qualified specialist workshop following an accident.

! NOTE Damage caused by trapping the seat belt

If an unused seat belt is not fully retracted, it may become trapped in the door or in the seat mechanism.

- ▶ Always ensure that an unused seat belt is fully retracted.

Information on the belt airbag in the rear seat belt

The BELTBAG symbol indicates that a rear seat belt is equipped with a belt airbag.

When activated, the belt airbag increases the protected area of the vehicle occupant's ribcage.

⚠ WARNING Risk of injury or death due to use of a non-approved child restraint system

In an accident, the beltbag may damage a non-approved child restraint system.

As a result, the child restraint system may not be able to provide the intended level of protection.

- ▶ Therefore, always use LATCH-type (ISO-FIX) to fasten a child seat equipped with an integrated restraint system.

- ▶ For vehicles equipped with the optional rear seat-belt air bags ("beltbag"), only use a Mercedes-Benz approved booster seat with integrated backrest.
- ▶ Never use an air bag equipped seat belt to fasten a front- or rear-facing child restraint system or a non-approved booster seat.
- ▶ Please contact an authorized Mercedes-Benz Center for information on approved child restraint systems.

Fastening and adjusting the seat belts

If the seat belt is pulled quickly or sharply, the seat belt retractor locks. The seat belt strap cannot be extracted any further.

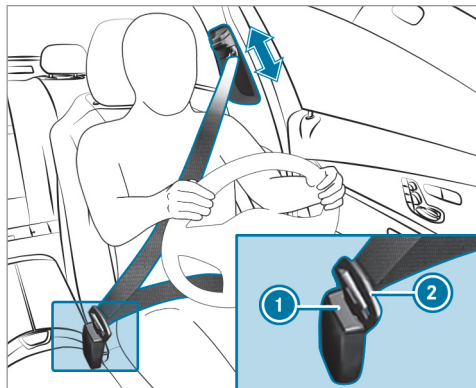

- ▶ Always engage seat belt tongue ② of the seat belt into seat belt buckle ① of the corresponding seat.
- ▶ Press and hold the seat belt outlet release and slide the seat belt outlet into the desired position.
- ▶ Let go of the belt outlet release and ensure that the seat belt outlet locks in position.

Vehicles with PRE-SAFE®: If the front seat belt is not pulled tight across your body, the seat belt adjustment may automatically apply a certain tightening force. Do not hold the seat belt tightly while it is adjusting. You can activate and deactivate the seat belt adjustment function using the multimedia system.

! **NOTE** Deployment of the Emergency Tensioning Device when the front passenger seat is unoccupied

If the seat belt tongue is engaged in the seat belt buckle of the front passenger seat and the front passenger seat is unoccupied, the Emergency Tensioning Device may deploy in the event of an accident.

- ▶ Only one person should use each seat belt at any one time.

Releasing the seat belts

- ▶ Press the release button in the seat belt buckle and guide the seat belt back with the seat belt tongue.

Activating or deactivating seat belt adjustment via the multimedia system

Multimedia system:

▶ **Vehicle** ▶ **Vehicle Settings** ▶ **Belt Adjustment**

- ▶ Activate or deactivate the function.

Seat belt warning for the driver and front passenger

The  seat belt warning lamp in the Instrument Display is a reminder that all vehicle occupants must wear their seat belts correctly.

The  seat belt warning lamp lights up for six seconds after every engine start.

In addition, there may be a warning tone.

When the front doors are closed and the driver and front passenger have fastened their seat belts, the seat belt warning goes out.

During a journey, the seat belt warning lights up if:

- The vehicle speed exceeds 15 mph (25 km/h) and the driver's or front passenger seat belt is not fastened.
- The driver or front passenger unfastens their seat belt while the vehicle is in motion.

Airbags

Overview of air bags

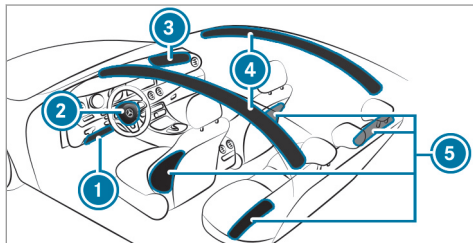

- ① Knee air bag
- ② Driver's air bag

- ③ Front passenger air bag
- ④ Window air bag
- ⑤ Side air bag

The installation location of an air bag is identified by the AIRBAG symbol.

When activated, an air bag can provide additional protection for the respective vehicle occupant.

AIRBAG	Potential protection for ...
Knee air bag	Thigh, knee and lower leg
Driver's air bag, front passenger air bag	Head and ribcage
Window air bag	Head
Side air bag	Ribcage, also pelvis for front seat occupants

The front passenger air bag can only be deployed in an accident if the PASSENGER AIR BAG OFF indicator lamp is off. If the front

passenger seat is occupied, make sure, both before and during the journey, that the status of the front passenger air bag is correct (→ page 41) .

! **NOTE** Important points to remember if the front passenger seat is unoccupied

In an accident, the components of the restraint system may deploy unnecessarily on the front passenger side if:

- There are heavy objects on the front passenger seat.
 - The seat belt tongue is engaged in the seat belt buckle of the front passenger seat and the front passenger seat is unoccupied.
- ▶ Stow objects in a suitable place.
- ▶ Only one person should use each seat belt at any one time.

Protection by the airbags

Depending on the accident situation, an airbag can add to the protection offered by a correctly fastened seat belt.

⚠ WARNING Risk of injury or death due to incorrect seat position

If you deviate from the correct seat position, the airbag cannot perform its intended protective function and deployment may even cause further injuries.

To avoid hazardous situations, always make sure that all vehicle occupants:

- Are seated properly and keep as far away as possible from the airbags.
 - Observe the following information.
- ▶ Always make sure that there are no objects between the airbag and the vehicle occupant.

To avoid risks resulting from the deployment of the airbag:

- Before starting your journey, adjust your seat correctly; the driver's seat and front passenger seat should be moved as far back as possible.

When doing so, always observe the information on the correct driver's seat position (→ page 81).

- Only hold the steering wheel by the steering wheel rim. This allows the airbag to be fully deployed.
- Always lean against the seat backrest when the vehicle is in motion. Do not lean forwards or lean against the door or side window. You may otherwise be in the deployment area of the airbags.
- Always keep your feet on the floor. Do not put your feet on the cockpit, for example. Your feet may otherwise be in the deployment area of the airbag.
- If children are traveling in the vehicle, observe the additional notes (→ page 45).
- Always stow and secure objects correctly.

Objects in the vehicle interior may prevent an airbag from functioning correctly. Therefore always ensure that:

- There are no people, animals or objects between the vehicle occupants and an airbag.
- There are no objects between the seat, door and door pillar (B-pillar).
- No hard objects, e.g. coat hangers, are hanging on the grab handles or coat hooks.
- No accessories, such as cup holders, are attached to the vehicle within the deployment area of an airbag, e.g. to doors, side windows or side paneling.
- No heavy, sharp-edged or fragile objects are in the pockets of your clothing. Store such objects in a suitable place.

Reduced airbag protection

⚠ WARNING Risk of injury from modifications to the airbag cover

If you modify an airbag cover or affix objects such as stickers to it, the airbag can no longer function correctly.

- ▶ Never modify an airbag cover and do not affix objects to it.

⚠ WARNING Risk of injury due to unsuitable seat covers

Unsuitable seat covers can obstruct or prevent the deployment of the airbags integrated into the seats.

Consequently, the airbags cannot protect vehicle occupants as they are designed to do. In addition, the operation of the automatic front passenger airbag shutoff system could be restricted. This poses an increased risk of injury or even fatal injury.

- ▶ You should only use seat covers that have been approved for the corresponding seats by Mercedes-Benz.

⚠ WARNING Risk of injury due to malfunctions of the sensors in the door paneling

Sensors to control the airbags are located in the doors. Modifications or work not performed correctly to the doors or door paneling, as well as damaged doors, can lead to the function of the sensors being impaired. The airbags might therefore not function properly any more.

Consequently, the airbags cannot protect vehicle occupants as they are designed to do.

- ▶ Never modify the doors or parts of the doors.
- ▶ Always have work on the doors or door paneling carried out at a qualified specialist workshop.

⚠ WARNING Risk of injury due to deployed airbag

A deployed airbag no longer has a protective function and cannot protect as intended in the event of an accident.

- ▶ Have the vehicle towed to a qualified specialist workshop in order to have the deployed airbag replaced.

Have deployed airbags replaced immediately.

Status of the front passenger airbag

Points to remember when the front passenger seat is occupied

The automatic front passenger airbag shutoff is able to detect whether the front passenger seat is occupied by a person or a child restraint system. The front passenger airbag is enabled or disabled accordingly.

When installing a child restraint system on the front passenger seat:

- Ensure that the child restraint system is positioned correctly .

- Always observe the child restraint system manufacturer's installation instructions.
- Never place objects under or behind the child restraint system, e.g. cushions.
- Fully retract the seat cushion length adjustment.
- The entire base of the child restraint system must always rest on the sitting surface of the front passenger seat.
- The backrest of the forward-facing child restraint system must lie as flat as possible against the backrest of the front passenger seat.
- The child restraint system must not touch the roof or be put under strain by the head restraints. Adjust the seat backrest inclination and the head restraint setting accordingly.

⚠ WARNING Risk of injury or death due to objects between the sitting surface and the child restraint system

Objects between the sitting surface and the child restraint system could affect the function of the automatic front passenger airbag shutoff.

This could result in the front passenger airbag not functioning as intended during an accident.

- ▶ Do not place any objects between the sitting surface and the child restraint system.
- ▶ The entire base of the child restraint system must always rest on the sitting surface of the front passenger seat.
- ▶ The backrest of the forward-facing child restraint system must lie as flat as possible against the backrest of the front passenger seat.
- ▶ Always comply with the child restraint system manufacturer's installation instructions.

A person in the front passenger seat must:

- Have their seat belt fastened correctly.
- Sit in an almost upright position with their back against the seat backrest.
- With their feet resting on the floor, if possible

Otherwise, the front passenger airbag may be deactivated by mistake, for example because the front passenger:

- Transfers their weight by supporting themselves on a vehicle armrest.
- Sits in such a way that their weight is raised from the sitting surface.

⚠ WARNING Risk of injury or death due to deactivated front passenger airbag

If the PASSENGER AIR BAG OFF indicator lamp is lit, the front passenger airbag is disabled. It will not be deployed in the event of an accident and cannot perform its intended protective function.

A person in the front passenger seat could then, for example, come into contact with

the vehicle interior, especially if the person is sitting too close to the cockpit.

If the front passenger seat is occupied, always ensure that:

- The classification of the person in the front passenger seat is correct and the front passenger airbag is enabled or disabled in accordance with the person in the front passenger seat.
 - The front passenger seat has been moved as far back as possible.
 - The person is seated correctly.
- Ensure, both before and during the journey, that the status of the front passenger airbag is correct.

PASSENGER AIR BAG indicator lamp

System self-test

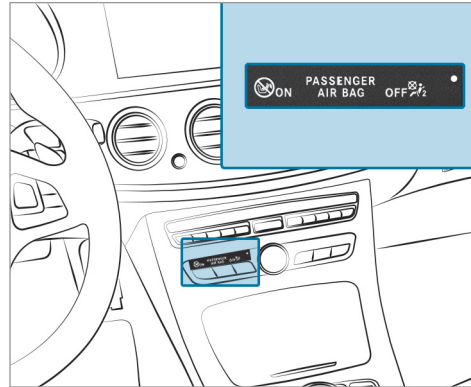

When the ignition is switched on, a system self-test is performed during which the two PASSENGER AIR BAG ON and OFF indicator lamps light up simultaneously.

The status of the front passenger airbag is then displayed:

- PASSENGER AIR BAG ON lights up for 60 seconds, subsequently both indicator lamps are off (PASSENGER AIR BAG ON and OFF): the front passenger airbag is able to deploy in the event of an accident.
- PASSENGER AIR BAG OFF lights up continuously: the front passenger airbag is disabled. It will then not be deployed in the event of an accident.

If the PASSENGER AIR BAG ON indicator lamp is off, only the PASSENGER AIR BAG OFF indicator lamp shows the status of the front passenger airbag. The PASSENGER AIR BAG OFF indicator lamp may be lit continuously or be off.

If the PASSENGER AIR BAG OFF indicator lamp and the  restraint system warning lamp light up simultaneously, the front passenger seat may not be used. Also in this case, do not install a child restraint system on the front passenger seat. Have the automatic front passenger airbag shutoff checked and repaired immediately at a qualified specialist workshop.

Status display

If the front passenger seat is occupied, ensure, both before and during the journey, that the status of the front passenger air bag is correct for the prevailing situation.

After installing a rearward-facing child restraint system on the front passenger seat:

The PASSENGER AIR BAG OFF indicator lamp must be lit continuously.

⚠ WARNING Risk of injury or death caused by using a rearward-facing child restraint system when the front passenger airbag is enabled

If you secure a child in a rearward-facing child restraint system on the front passenger seat and the PASSENGER AIR BAG OFF indicator lamp is off, the front passenger airbag can deploy in the event of an accident. The child could be struck by the airbag.

Always make sure that the front passenger airbag is disabled. The PASSENGER AIR BAG OFF indicator lamp must be lit.

When installing a child restraint system on the front passenger seat, observe the vehicle-specific information (→ page 39).

Depending on the child restraint system and the stature of the child, the PASSENGER AIR BAG OFF indicator lamp may be off. In this case, do not install the rearward-facing child restraint system on the front passenger seat.

Instead, install the rearward-facing child restraint system on a suitable rear seat.

After installing a forward-facing child restraint system on the front passenger seat:

Depending on the child restraint system and the stature of the child, the PASSENGER AIR BAG OFF indicator lamp may be permanently lit or off. Always observe the following information.

⚠ WARNING Risk of injury or death due to incorrect positioning of the forward-facing child restraint system

If you secure a child in a forward-facing child restraint system on the front passenger seat and you position the front passenger seat too close to the cockpit, in the event of an accident, the child could:

- Come into contact with parts of the vehicle interior if the PASSENGER AIR BAG OFF indicator lamp is lit, for example.
 - Be struck by the airbag if the PASSENGER AIR BAG OFF indicator lamp is off
- ▶ Always move the front passenger seat as far back as possible and fully retract the seat cushion length adjustment. Always make sure that the shoulder belt strap is correctly routed from the seat belt outlet on the vehicle to the shoulder belt guide on the child restraint system. The shoulder belt strap must be routed forwards and downwards from the seat belt outlet. If necessary, adjust

the seat belt outlet and the front passenger seat accordingly.

- ▶ Always observe the child restraint system manufacturer's installation instructions.

When installing a child restraint system on the front passenger seat, observe the vehicle-specific information (→ page 39).

If a person is sitting in the front passenger seat:

The PASSENGER AIR BAG OFF indicator lamp may be lit continuously or be off, depending on the person's stature. Always observe the following information.

If the front passenger seat is occupied by:

- An adult or a person with a build corresponding to that of an adult, the PASSENGER AIR BAG OFF indicator lamp must be off. This indicates that the front passenger air bag is enabled.

If the PASSENGER AIR BAG OFF indicator lamp is lit continuously, an adult or person with a build corresponding to that of an adult should not use the front passenger seat. Instead, they should use a rear seat.

- A person with a smaller build (e.g. a teenager or small adult), the PASSENGER AIR BAG OFF indicator lamp either lights up and remains lit depending on the result of the classification or, alternatively, goes out.
 - PASSENGER AIRBAG OFF is off: move the front passenger seat as far back as possible or a person with a smaller stature should use a rear seat.
 - If the PASSENGER AIR BAG OFF indicator lamp is lit continuously: a person with a smaller stature should not use the front passenger seat.

⚠ WARNING Risk of injury or death when the PASSENGER AIR BAG OFF indicator lamp is lit

If the PASSENGER AIR BAG OFF indicator lamp remains lit after the system self-test,

the front passenger airbag is disabled. It will not be deployed in the event of an accident. In this case, the front passenger airbag cannot perform its intended protective function, e.g. when a person is seated in the front passenger seat.

That person could, for example, come into contact with the vehicle interior, especially if the person is sitting too close to the cockpit.

If the front passenger seat is occupied, always ensure that:

- The classification of the person in the front passenger seat is correct and the front passenger airbag is enabled or disabled in accordance with the person in the front passenger seat.
- The person is seated properly with a correctly fastened seat belt.
- The front passenger seat has been moved as far back as possible.

Further related subjects:

- Child restraint system on the front passenger seat (→ page 51).

PRE-SAFE®

Information on PRE-SAFE® (anticipatory occupant protection)

PRE-SAFE® is able to detect certain critical driving situations and implement pre-emptive measures to protect the vehicle occupants.

PRE-SAFE® can implement the following measures independently of each other:

- Tighten the seat belts on the driver's seat and front passenger seat.
- Close the side windows.
- **Vehicles with sliding sunroof:** Close the sliding sunroof.
- **Vehicles with memory function:** Move the front passenger seat to a more favorable seat position.
- **Vehicles with multicontour seat:** Increase the air pressure in the seat side bolsters of the seat backrest.
- PRE-SAFE® Sound: provided that the multimedia system is switched on, generates a

brief noise signal to stimulate the innate protective mechanism of a person's hearing.

NOTE Damage caused by objects in the footwell or behind the seat

The automatic adjustment of the seat position may result in damage to the seat and/or the object.

▶ Stow objects in a suitable place.

Reversing the PRE-SAFE® measures

If an accident did not occur, the pre-emptive measures that were taken are reversed. You will need to perform certain settings yourself.

▶ If the seat belt pre-tensioning is not reduced, move the seat backrest back slightly. The locking mechanism releases.

PRE-SAFE® PLUS (anticipatory occupant protection plus)

PRE-SAFE® PLUS can detect certain impacts, particularly an imminent rear impact, and take pre-emptive measures to protect the vehicle occupants. These measures cannot necessarily prevent an imminent impact.

PRE-SAFE® PLUS can implement the following measures independently of each other:

- Tightening the seat belts on the driver's seat and front passenger seat.
If an accident does not occur, the pre-emptive measures that were taken are reversed (→ page 44).
- Increasing brake pressure when the vehicle is stationary. This brake application is canceled automatically when the vehicle pulls away.

PRE-SAFE® PLUS system limitations

- No measures are implemented:
 - if the vehicle is backing up.
- The brakes are not applied:

- while the vehicle is in motion.
or
- when entering or exiting a parking space while using Active Parking Assist.

Information on PRE-SAFE® Impulse Side

If an imminent side impact is detected, PRE-SAFE® Impulse Side can pre-emptively move the front-seat vehicle occupant's upper body towards the center of the vehicle. It does this by rapidly inflating an air cushion in the outer seat side bolster of the seat backrest on the side on which the impact is anticipated. This increases the distance between the door and the vehicle occupant.

If PRE-SAFE® Impulse Side has been deployed or is faulty, the display message **PRE-SAFE Impulse Side Inoperative** See Operator's Manual is displayed (→ page 337) .

Children in the vehicle

Notes on the safe transportation of children

⚠ WARNING Risk of accident and injury due to children left unattended in the vehicle

If you leave children unaccompanied in the vehicle, they may be able to set the vehicle in motion, for example by:

- Releasing the parking brake.
- Shifting the transmission out of park position **P**.
- Starting the engine.

In addition, they may operate vehicle equipment.

- ▶ Never leave children and animals unattended in the vehicle.
- ▶ When leaving the vehicle, always take the SmartKey with you and lock the vehicle.

⚠ WARNING Risk of fatal injury due to exposure to extreme heat or cold in the vehicle

If people – particularly children – are exposed to extreme heat or cold over an extended period of time, there is a risk of injury or even fatal injury.

- ▶ Never leave anyone – particularly children – unattended in the vehicle.

⚠ WARNING Risk of burns when the child seat is exposed to direct sunlight

If the child restraint system is exposed to direct sunlight or heat, parts could heat up. Children could suffer burns on these parts, particularly on metallic parts of the child restraint system.

- ▶ Always make sure that the child restraint system is not exposed to direct sunlight.
- ▶ Protect it with a blanket, for example.

- ▶ If the child restraint system has been exposed to direct sunlight, allow it to cool before securing a child into it.
- ▶ Never leave children unattended in the vehicle.

The use of seat belts and child restraint systems is required by law in:

- all 50 states
- the U.S. territories
- the District of Columbia
- all Canadian provinces

All child restraint systems must meet the following standards:

- U.S. Federal Motor Vehicle Safety Standards 213 and 225
- Canadian Motor Vehicle Safety Standards 213 and 210.2

You can obtain further information about the correct child restraint system from any authorized Mercedes-Benz Center.

To improve protection for children younger than 12 years old and under 5 ft (1.50 m) in height, Mercedes-Benz recommends you observe the following notes:

- Only secure children using a child restraint system which is suitable for Mercedes-Benz vehicles and which is appropriate for the age, weight and height of the child. Be sure to observe the instructions for correct use of the child restraint system.
- Install the child restraint system on a rear seat if possible.
- Only use the following securing systems for child restraint systems:
 - The seat belt system.
 - The LATCH-type (ISOFIX) mounting bracket.
 - The Top Tether anchorages.
- The manufacturer's installation instructions for the child restraint system.
- The warning labels in the vehicle interior and on the child restraint system.

⚠ WARNING Risk of injury caused by incorrect installation of the child restraint system

If the child restraint system is incorrectly installed on a suitable seating position, it cannot perform its intended protective function.

The child cannot be restrained in the event of an accident, heavy braking or a sudden change of direction. This poses an increased risk of injury or even fatal injury.

- ▶ Always comply with the manufacturer's installation instructions for the child restraint system and its correct use.
- ▶ Make sure that the entire base of the child restraint system always rests on the sitting surface of the seat.
- ▶ Never place objects under or behind the child restraint system, e.g. a cushion.
- ▶ Always use child restraint systems with the original cover designed for them.

- ▶ Always replace damaged covers with genuine covers.

▲ WARNING Risk of accident caused by incorrectly installed child restraint systems

If the child restraint system is not correctly installed or secured, it could release in the event of an accident, sudden braking or a sudden change in direction.

The child restraint system could be flung around and hit vehicle occupants. This poses an increased risk of injury or even fatal injury.

- ▶ Always install child restraint systems correctly, even when not in use.
- ▶ Always comply with the child restraint system manufacturer's installation instructions.

▲ WARNING Risk of injury caused by the use of damaged child restraint systems

Child restraint systems or their retaining systems that have been subjected to a load in an accident may then not be able to perform their intended protective function.

The child cannot be restrained in the event of an accident, heavy braking or a sudden change of direction. This poses an increased risk of injury or even fatal injury.

- ▶ Always replace child restraint systems immediately that have been damaged or involved in an accident.
- ▶ Have the securing systems for the child restraint systems checked at a qualified specialist workshop before installing a child restraint system again.

A booster seat may be necessary to achieve proper seat belt positioning for children that weigh more than 40 lbs (18 kg) or until they reach a height where a three-point seat belt can be worn properly without a booster seat.

The following notes must be observed:

- When installing a child restraint system on the front passenger seat, the information on installing a child restraint system on the front passenger seat (→ page 51).
- Instructions and safety notes on automatic front passenger airbag shutoff (→ page 39).
- Safety notes and instructions on the correct use of the seat belt (→ page 36).

Activating/deactivating the child seat safety feature of the seat belt

▲ WARNING Risk of injury or death if a seat belt is unfastened while the vehicle is in motion

If the seat belt is released while the vehicle is in motion, the child restraint system is no longer correctly secured. The child seat safety feature is deactivated and the seat belt is drawn in a bit by the inertia reel.

It is therefore not possible to engage the seat belt again.

- ▶ Pull over and stop the vehicle safely as soon as possible, paying attention to road and traffic conditions.
- ▶ Activate the child seat safety feature again and correctly secure the child restraint system.

When enabled, the special seatbelt retractor ensures that the seat belts of the rear seats do not slacken once the child restraint system is secured.

Always comply with the manufacturer's installation instructions when installing and removing the child restraint system.

Activating the child seat safety feature:

- ▶ Pull the seat belt out fully and let the inertia reel retract it again. When the child seat safety feature is activated, you should hear a ratcheting sound.
- ▶ Push the child restraint system down until the seat belt sits tightly.

Deactivating the child seat safety feature:

- ▶ Press the release button of the seat belt buckle.
- ▶ Hold the seat belt tongue and guide back to the seat belt outlet.

LATCH-type (ISOFIX) child seat attachment

Notes on LATCH-type (ISOFIX) child seat attachments

⚠ WARNING Risk of injury when using the LATCH-type (ISOFIX) child restraint system and exceeding the permissible weight

LATCH-type (ISOFIX) child restraint systems do not offer sufficient protection for children weighing more than 49 lb (22 kg) who are secured using the seat belt integrated in the child restraint system.

For example, the child may not be restrained correctly in the event of an accident. This poses an increased risk of injury or even fatal injury.

- ▶ If the child weighs more than 49 lb (22 kg), only use LATCH-type (ISOFIX) child restraint systems with which the child is secured using the seat belt of the vehicle seat.
- ▶ Also secure the child restraint system with the Top Tether belt, if available.

When installing a child restraint system, be sure to observe the manufacturer's installation instructions and the instructions for correct use of the child restraint system.

ISOFIX is a standardized securing system for special restraint systems. LATCH-type (ISOFIX) child restraint systems are approved in accordance with ECE R-44.

Only child restraint systems that have been approved in accordance with ECE R-44 may be attached to LATCH-type (ISOFIX) mounting brackets.



The symbol for attaching a LATCH-type (ISOFIX) child restraint system

Installing LATCH-type (ISOFIX) child seat attachments

▲ WARNING Risk of injury when using the LATCH-type (ISOFIX) child restraint system and exceeding the permissible weight

LATCH-type (ISOFIX) child restraint systems do not offer sufficient protection for children weighing more than 49 lb (22 kg) who are secured using the seat belt integrated in the child restraint system.

For example, the child may not be restrained correctly in the event of an accident. This poses an increased risk of injury or even fatal injury.

- ▶ If the child weighs more than 49 lb (22 kg), only use LATCH-type (ISOFIX) child restraint systems with which the child is secured using the seat belt of the vehicle seat.
- ▶ Also secure the child restraint system with the Top Tether belt, if available.

When installing a child restraint system, be sure to observe the manufacturer's installation instructions and the instructions for correct use of the child restraint system.

Before every trip, make sure that the LATCH-type (ISOFIX) child restraint system is engaged correctly in both LATCH-type (ISOFIX) mounting brackets.

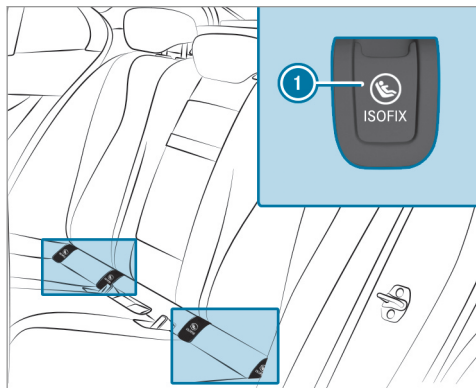

① LATCH-type (ISOFIX) mounting brackets

1 **NOTE** Damage to the seat belt for the center seat

When installing a child restraint system, the seat belt for the center seat could be damaged.

▶ Make sure that the seat belt is not trapped.

- ▶ Remove each cover for LATCH-type (ISOFIX) mounting brackets ①.
- ▶ Attach the LATCH-type (ISOFIX) child restraint system to both LATCH-type (ISOFIX) mounting brackets ①.
- ▶ Replace each cover for LATCH-type (ISOFIX) mounting brackets ① after removing the child seat.

Securing Top Tether

⚠ WARNING Risk of injury if the rear bench seat/rear seat and seat backrest are not engaged

If the rear bench seat/rear seat and seat backrest are not engaged they could fold forwards, e.g. when braking suddenly or in the event of an accident.

- If this is the case, the vehicle occupant would be forced into the seat belt by the rear bench seat/rear seat or by the seat backrest. The seat belt cannot protect as intended and could result in additional injury.
- Objects or loads in the trunk cannot be restrained by the seat backrest.
- ▶ Make sure that the seat backrest and the rear bench seat/rear seat are engaged before every trip.

If the seat backrest is not engaged and locked, this will be shown in the multifunction display in the instrument cluster.

The risk of injury can be reduced by Top Tether as Top Tether provides an additional connection between the child restraint system secured with LATCH-type (ISOFIX) and the vehicle.

The child restraint system must be equipped with a Top Tether belt.

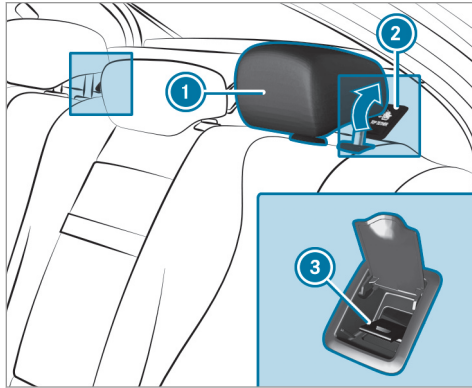

- ▶ If necessary, move head restraint ① up (→ page 87).
- ▶ Fold up cover ② of Top Tether anchorage ③.
- ▶ Install the LATCH-type (ISOFIX) child restraint system with Top Tether. Always comply with the child restraint system manufacturer's installation instructions when doing so.

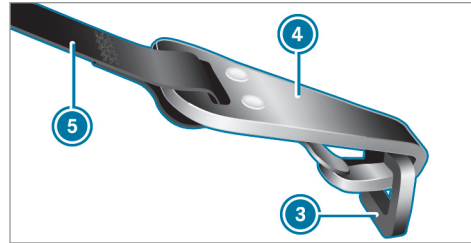

- ▶ Route Top Tether belt ⑤ under head restraint ① between the two head restraint bars.
- ▶ Hook Top Tether hook ④ of Top Tether belt ⑤ without twisting into Top Tether anchorage ③.
- ▶ Tension Top Tether belt ⑤. Always comply with the child restraint system manufacturer's installation instructions when doing so.
- ▶ Fold down cover ② of Top Tether anchorage ③.
- ▶ If necessary, move head restraint ① down (→ page 87). Make sure that you do not

interfere with the correct routing of Top Tether belt ⑤.

Child restraint systems on the front passenger seat

Notes on child restraint systems on the front passenger seat

Accident statistics show that children secured in the rear seats are safer than children secured in the front seats. For this reason, Mercedes-Benz strongly advises that you install a child restraint system on a rear seat.

If it is absolutely necessary to install a child restraint system on the front passenger seat, always observe the information on the automatic front passenger air bag shutoff (→ page 39).

By doing this, you can avoid risks caused by:

- A child restraint system that is not detected by the automatic front passenger air bag shutoff.
- The unintentionally deactivated front passenger air bag.

- Incorrect positioning of the child restraint system.

Forward-facing and rearward-facing child restraint systems on the front passenger seat

When using a rearward-facing child restraint system on the front passenger seat, the front passenger airbag must always be disabled. This is only the case if the PASSENGER AIR BAG OFF indicator lamp is lit continuously (→ page 41) .

When using a child restraint system on the front passenger seat, it is essential to observe the following:

- Move the front passenger seat as far back as possible.
- Retract the seat cushion length as far as possible.
- The entire base of the child restraint system must always rest on the sitting surface of the front passenger seat.
- The backrest of the forward-facing child restraint system must lie as flat as possible against the backrest of the front passenger seat. The child restraint system must not

touch the roof or be put under strain by the head restraints.

- Adjust the angle of the seat backrest and the head restraint position accordingly.
- Move the seat cushion inclination to the highest, most vertical position.
- Always make sure that the shoulder belt strap is correctly routed from the seat belt outlet of the vehicle to the shoulder belt guide on the child restraint system. The shoulder belt strap must be routed forwards and downwards from the seat belt outlet.
- If necessary, adjust the seat belt outlet and the front passenger seat accordingly.
- Never place objects under or behind the child restraint system, e.g. a cushion.

Always comply with the manufacturer's installation and operating instructions for the child restraint system used.

Child safety locks

Activating/deactivating the child safety lock for the rear doors

⚠ WARNING Risk of accident and injury due to children left unattended in the vehicle

If you leave children unattended in the vehicle, they may be able to set the vehicle in motion, for example by:

- Releasing the parking brake.
- Shifting the automatic transmission out of park position **P** or shifting the manual transmission into neutral.
- Starting the engine.

In addition, they may operate vehicle equipment.

- ▶ Never leave children and animals unattended in the vehicle.
- ▶ When leaving the vehicle, always take the SmartKey with you and lock the vehicle.

⚠ WARNING Risk of fatal injury due to exposure to extreme heat or cold in the vehicle

If people – particularly children – are exposed to extreme heat or cold over an extended period of time, there is a risk of injury or even fatal injury.

- ▶ Never leave anyone – particularly children – unattended in the vehicle.

⚠ WARNING There is a risk of accident and injury if you leave children unattended in the vehicle

If children are traveling in the vehicle, they could:

- Open doors, thereby endangering other persons or road users.
- Get out of the vehicle and be hit by oncoming traffic.
- Operate vehicle equipment and become trapped, for example.

- ▶ Always activate the child safety locks available if children are traveling in the vehicle.
- ▶ Never leave children unattended in the vehicle.
- ▶ When leaving the vehicle, always take the SmartKey with you and lock the vehicle.

Child safety locks are available for the rear doors and for the rear side windows. The child safety lock on the rear doors secures each door separately. The doors can no longer be opened from the inside.

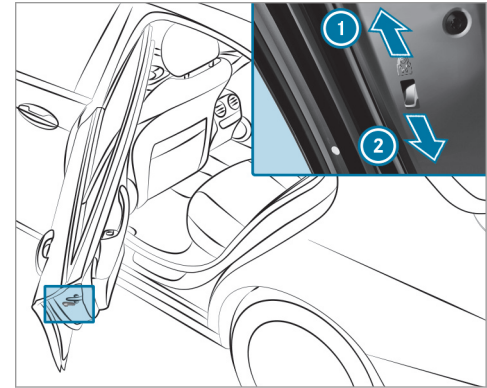

- ▶ Press the lever in direction ① (**activate**) or ② (**deactivate**).
- ▶ Make sure that the child safety locks are working properly.

Activating/deactivating the child safety lock for the rear side windows

Child safety locks are available for the rear doors and for the rear side windows.

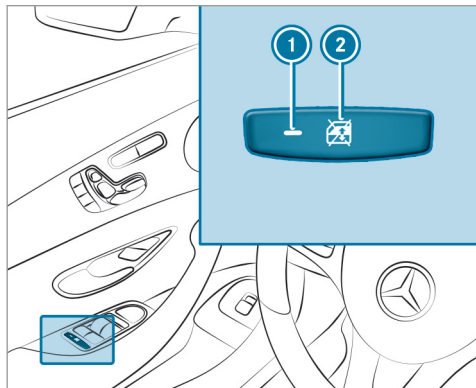

▶ **To activate/deactivate:** press button ②.

Opening/closing the rear side windows is possible:

- With indicator lamp ① lit: via the switch on the driver's door.
- With indicator lamp ① off: via the switch on the corresponding rear door or driver's door.

Pets in the vehicle

⚠ WARNING Risk of accident and injury due to animals left unattended in the vehicle

If you leave animals in the vehicle unattended or unsecured, they could possibly press down buttons or switches.

Thereby an animal may:

- activate vehicle equipment and become trapped, for example.
- switch systems on or off and endanger other road users.

Unsecured animals may be thrown around in the vehicle in the event of an accident or sudden steering and braking maneuvers and injure vehicle occupants in the process.

- ▶ Never leave animals in the vehicle unattended.
- ▶ Always correctly secure animals while driving, e.g. using a suitable animal carrier.

SmartKey

Overview of SmartKey functions

⚠ WARNING - Danger of accident or injury if children are left unattended in the vehicle

If children are left unattended in the vehicle, they could:

- open doors, thereby endangering other persons or road users.
- get out of the vehicle and be hit by oncoming traffic.
- operate vehicle equipment.

Moreover, children could also set the vehicle in motion by, for example:

- releasing the parking brake.
- shifting the automatic transmission out of park position P **P** or shifting manual transmission into idle position.
- starting the engine.

- ▶ Never leave children and animals unattended in the vehicle.
- ▶ When leaving the vehicle, always take the key with you and lock the vehicle.
- ▶ Keep the vehicle key out of the reach of children.

! NOTE Damage to the key caused by magnetic fields

- ▶ Keep the key away from strong magnetic fields.

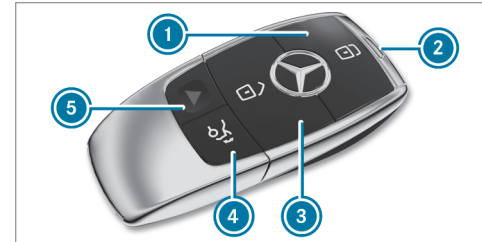

- ① To lock
- ② Battery check lamp
- ③ To unlock
- ④ To open/close the trunk lid
- ⑤ Panic alarm

The SmartKey locks and unlocks the following components:

- The doors
- The trunk lid
- The fuel filler flap

If you do not open the vehicle within approximately 40 seconds after unlocking:

- The vehicle is locked again.
- Anti-theft protection is reactivated.

Do not keep the SmartKey together with electronic devices or metal objects. This can affect the operation of the SmartKey.

- ❗ If battery check lamp ❷ does not light up after pressing the  or  button, the battery is discharged.

Activating/deactivating the acoustic locking verification signal

Multimedia system:

➔ [Vehicle](#) ➔ [Vehicle Settings](#) ➔ [Acoustic Lock](#)

- ▶ Activate or deactivate the function.

Priming/deactivating the panic alarm

Prerequisites

- Ignition switched off.



- ▶ **To prime:** press button ❶ for approximately one second.

A visual and audible alarm is triggered.

- ▶ **To deactivate:** briefly press button ❶ again.



or

- ▶ Press the start/stop button on the cockpit (the SmartKey is inside the vehicle).

Changing the unlocking settings

Possible unlocking functions of the SmartKey:

- Central unlocking.
- Unlocking the driver's door and fuel filler flap

- ▶ **To switch between settings:** press the  and  buttons simultaneously for approximately six seconds until the battery check lamp flashes twice.

If the unlocking function for the driver's door and fuel filler flap has been selected:

- Pressing the  button a second time centrally unlocks the vehicle.
- **Vehicles with KEYLESS-GO:** If you touch the inner surface of the door handle on the driver's door, only the driver's door and fuel filler flap are unlocked.

Reducing the energy consumption of the key

If you do not intend to use the vehicle for an extended period of time, you can deactivate the following functions on the key.

- KEYLESS-GO starting function
- KEYLESS-GO

- ▶ **To deactivate:** press the  button on the key twice in rapid succession. The battery indicator lamp of the key flashes twice briefly and lights up once.
- ▶ **To activate:** press any button on the key.
- ⓘ When the vehicle is started with the key in the stowage compartment of the center console (→ page 129), the key functions are automatically activated.

Inserting/removing the emergency key

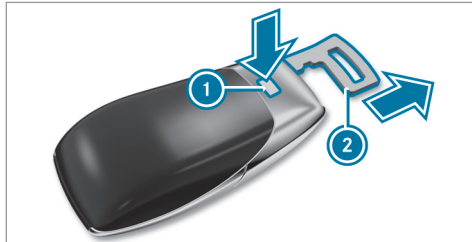

- ▶ Press release knob ①. Emergency key ② is pushed out slightly.

- ▶ Pull out emergency key ② until it engages.
- ⓘ You can use the emergency key in this position to attach the SmartKey onto a key ring.
- ▶ Press release knob ① again and remove the emergency key.
- ▶ **To insert:** insert the emergency key along the inside of the SmartKey until it engages.
- ▶ Press release knob ① and press in the emergency key fully until it engages.

Replacing the SmartKey battery

⚠ DANGER Serious damage to health caused by swallowing batteries

Batteries contain toxic and corrosive substances. Swallowing batteries may cause serious damage to health.

There is a risk of fatal injury.

- ▶ Keep batteries out of the reach of children.
- ▶ If batteries are swallowed, seek medical attention immediately.

! **ENVIRONMENTAL NOTE** Environmental damage caused by improper disposal of batteries



Batteries contain pollutants. It is illegal to dispose of them with the household rubbish.



Dispose of batteries in an environmentally responsible manner. Take discharged batteries to a qualified specialist workshop or to a collection point for used batteries.

Prerequisites

You require a CR 2032 3 V cell battery.

Mercedes-Benz recommends that you have the battery replaced at a qualified specialist workshop.

- ▶ Remove the emergency key (→ page 57).



- ▶ Press release button ② down fully and remove cover ①.
- ▶ Remove battery compartment ③.
- ▶ Insert the new battery into battery compartment ③. Observe the positive pole marking in the battery compartment and on the battery.
- ▶ Push in battery compartment ③.
- ▶ Replace cover ① so that it engages.

Problems with the SmartKey

Problem	Possible causes/consequences and ▶ Solutions
<p>You can no longer lock or unlock the vehicle.</p>	<p>Possible causes are:</p> <ul style="list-style-type: none"> • The SmartKey battery is discharged or nearly discharged. • There is interference from a powerful radio signal source. • The SmartKey is faulty. <ul style="list-style-type: none"> ▶ Check the battery using the battery check lamp and replace if necessary (→ page 57). ▶ Use the emergency key to lock or unlock the vehicle (→ page 57). ▶ Have the SmartKey checked at a qualified specialist workshop.
<p>You have lost a SmartKey.</p>	<ul style="list-style-type: none"> ▶ Have the SmartKey deactivated at a qualified specialist workshop.

Problem**Possible causes/consequences and ► Solutions**

- If necessary, have the mechanical locking mechanism changed as well.

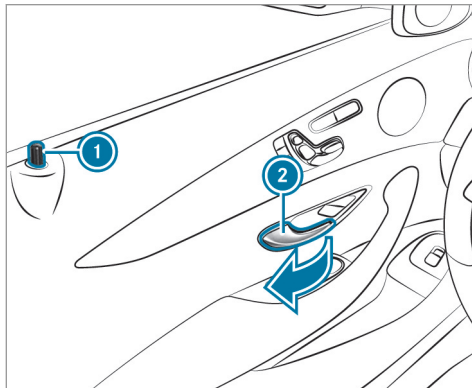
Doors**Unlocking and opening doors from the inside**

- **To unlock and open a front door:** pull door handle ②. Locking pin ① pops up when the door unlocks.
- **To unlock a rear door:** pull the rear door handle. The locking pin pops up when the rear door is unlocked.
- **To open a rear door:** pull the rear door handle again.

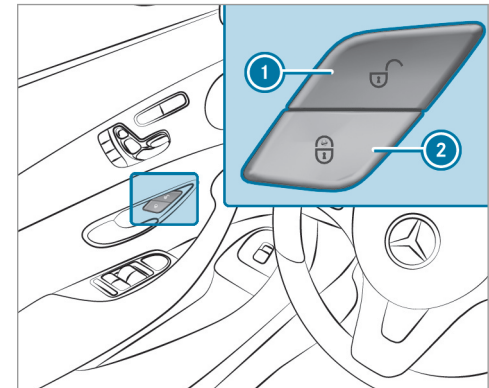
Locking/unlocking the vehicle centrally from the inside

- **To unlock:** press button ①.
- **To lock:** press button ②.

This does not lock or unlock the fuel filler flap.
The vehicle is not unlocked:

- If you have locked the vehicle using the SmartKey.
- If you have locked the vehicle using KEY-LESS-GO.

Unlocking/locking the vehicle via a mobile phone

Prerequisites

- Vehicle with the electronic vehicle SmartKey function in the smartphone.
- The electronic vehicle SmartKey function is activated in the smartphone via the Mercedes connect me web app: <http://www.mercedes.me>.
- Suitable mobile phone with an NFC antenna (Near Field Communication).
- Sufficient charge level of the mobile phone.

i You can check the suitability of your mobile phone by entering the phone number at <http://www.mercedes.me>.

i Further information on suitable mobile phones can be obtained from an authorized Mercedes-Benz Center or at <http://www.mercedes-benz.com/connect>.

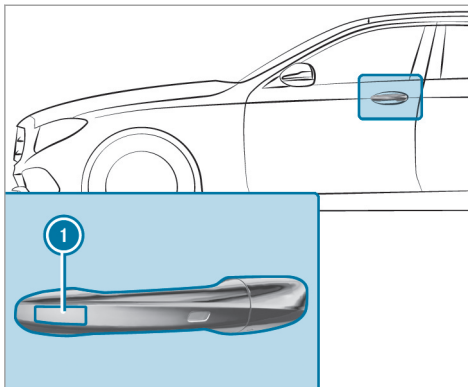

▶ With the part of the mobile phone where the NFC antenna is located, touch the door han-

dle on the driver's door in the area where NFC antenna **1** is located.
The vehicle is locked and unlocked alternately.

Locking and unlocking the vehicle with KEY-LESS-GO

Prerequisites

- The SmartKey must be outside the vehicle.
- The distance between the SmartKey and the vehicle must not exceed 3 ft (1 m).
- The driver's door and the door of the handle being used must both be closed.

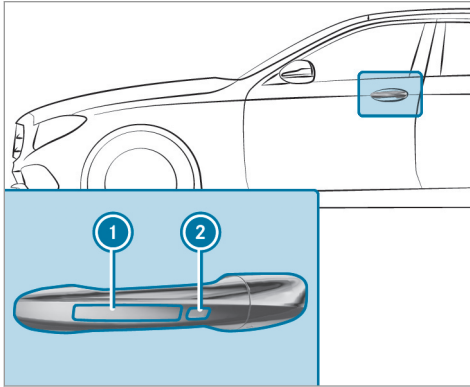

▶ **To unlock the vehicle:** touch the inner surface of the door handle.

▶ **To lock the vehicle:** touch sensor surface ① or ②.

▶ **Convenience closing:** touch recessed sensor surface ② for an extended period.

① For further information on convenience closing (→ page 72).

If you pull the handle of the trunk lid, the trunk lid is automatically unlocked.

Problems with KEYLESS-GO

Problem	Possible causes/consequences and ► Solutions
<p>You can no longer lock or unlock the vehicle using KEYLESS-GO.</p>	<p>Possible causes are:</p> <ul style="list-style-type: none"> • KEYLESS-GO has been deactivated (→ page 56). • The SmartKey battery is discharged or nearly discharged. • There is interference from a strong radio signal source.

Problem	Possible causes/consequences and ► Solutions
	<ul style="list-style-type: none">• The SmartKey is faulty.► Activate KEYLESS-GO (→ page 56).► Check the SmartKey battery using the battery check lamp and replace if necessary (→ page 57).► Use the emergency key to lock or unlock the vehicle (→ page 57).► Have the vehicle and SmartKey checked at a qualified specialist workshop.

Switching the automatic locking feature on/off

The vehicle is locked automatically when the ignition is switched on and the wheels are turning.

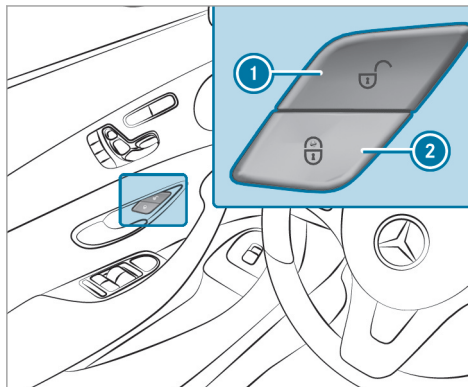

► **To deactivate:** press and hold button ① for approximately five seconds until an acoustic signal sounds.

► **To activate:** press and hold button ② for approximately five seconds until an acoustic signal sounds.

Danger of being locked out when the function is activated:

- If the vehicle is being tow started/pushed.
- On a roller dynamometer.

Unlocking/locking the driver's door using the emergency key

- i** If you wish to lock the vehicle entirely using the emergency key, first press the button for locking from the inside while the driver's door is open. Then proceed to lock the driver's door using the emergency key.

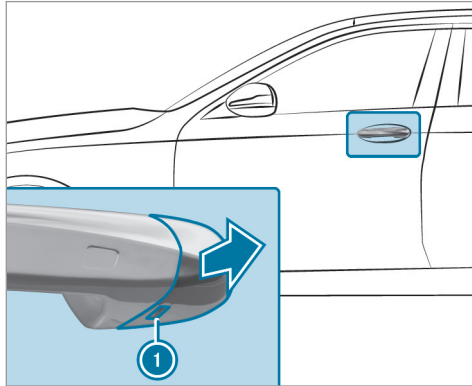

- ▶ Insert the emergency key into opening **1** in the cover.
- ▶ Pull and hold the door handle.
- ▶ Pull the cover on the emergency key as straight as possible away from the vehicle until it releases.
- ▶ Release the door handle.

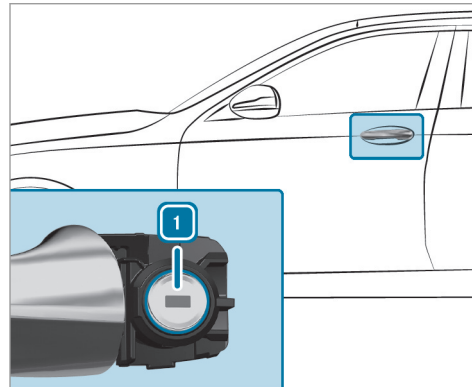

- ▶ **To unlock:** turn the emergency key counter-clockwise to position **1**.
- ▶ **To lock:** turn the emergency key clockwise to position **1**.
- ▶ Carefully press the cover onto the lock cylinder until it engages and is seated firmly.

Trunk

Opening the trunk lid

⚠ WARNING Risk of exhaust gas poisoning

Combustion engines emit poisonous exhaust gases such as carbon monoxide. Exhaust gases can enter the vehicle interior if the trunk lid is open when the engine is running, especially if the vehicle is in motion.

- ▶ Always switch off the engine before opening the trunk lid.
- ▶ Never drive with the trunk lid open.

! **NOTE** Damage to the trunk lid by obstacles above the vehicle

The trunk lid swings upwards when it is opened.

- ▶ Therefore, make sure that there is sufficient clearance above the trunk lid.

You have the following options to open the trunk lid:

- ▶ Pull the trunk lid handle.
- ▶ Press the  button in the SmartKey twice.

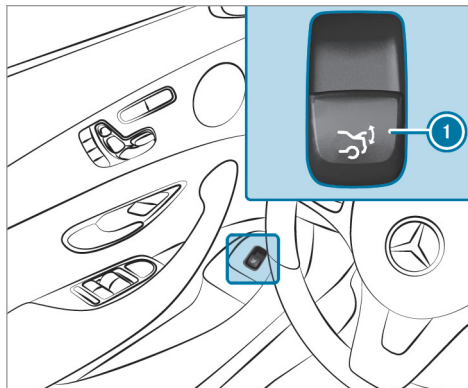

- ▶ Pull trunk lid remote operating switch ①.
- ▶ **Vehicles with HANDS-FREE ACCESS:** Use your foot to kick below the bumper (→ page 66).

Vehicles with trunk lid convenience closing:
If an object restricts the trunk lid during the automatic opening process, the obstacle detection stops the trunk lid.

Closing the trunk lid

! **WARNING** Risk of injury from unsecured items in the vehicle

If objects, luggage or loads are not secured or not secured sufficiently, they could slip, tip over or be flung around and thereby hit vehicle occupants.

There is a risk of injury, particularly in the event of sudden braking or a sudden change in direction.

- ▶ Always store objects in such a way that they cannot be flung around.
- ▶ Before the journey, secure objects, luggage or loads against slipping or tipping over.

! **WARNING** Risk of entrapment during automatic closing of the trunk lid

Parts of the body could become trapped during automatic closing of the trunk lid. Moreover, people, e.g. children, may be standing

in the closing area or may enter the closing area during the closing process.

- ▶ Make sure that nobody is in the vicinity of the closing area during the closing process.

Use one of the following options to stop the closing process:

- Press the  button on the SmartKey.
- Press or pull the remote operating switch on the driver's door.
- - Press the closing or locking button on the trunk lid.
- Pull the trunk lid handle.

Vehicles with HANDS-FREE ACCESS: It is also possible to stop the closing process by performing a kicking movement under the rear bumper.

You have the following options to close the trunk lid:

- ▶ Pull the trunk lid down using the handle recess and push it closed.

- ▶ **Vehicles with trunk lid convenience closing:** Briefly press the  button on the SmartKey twice (with the SmartKey located in the immediate vicinity of the vehicle).

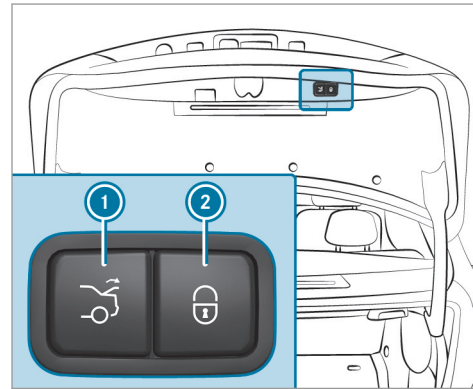

- ▶ **Vehicles with trunk lid convenience closing:** Press closing button ① in the trunk lid.

- ▶ **Vehicles with trunk lid convenience closing and KEYLESS-GO:** Press locking button ② in the trunk lid. If a SmartKey is detected outside the vehicle, the trunk lid closes and the vehicle is locked.

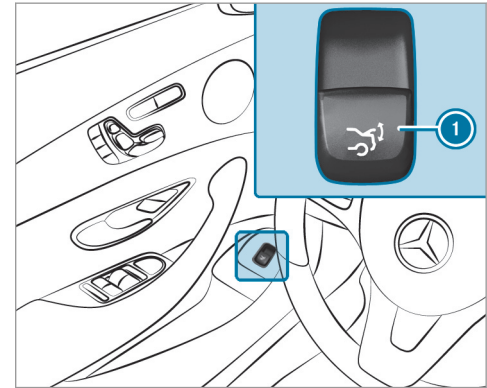

- ▶ **Vehicles with trunk lid convenience closing:** Press trunk lid remote operating switch ①.

▶ **Vehicles with HANDS-FREE ACCESS:** Use your foot to kick below the bumper (→ page 66).

Automatic reversing function of the trunk lid

If an object restricts the trunk lid during the automatic closing process, the trunk lid opens again automatically. The automatic reversing function is only an aid and is not a substitute for your attentiveness.

▶ When closing, make sure that no body parts are in the closing area.

⚠ WARNING Risk of becoming trapped despite the reversing function

The reversing function does not react:

- To soft, light and thin objects, e.g. fingers.
- Over the last $\frac{1}{3}$ in (8 mm) of the closing movement.

In these situations in particular, the reversing function cannot prevent someone being trapped.

▶ When closing, make sure that no body parts are in the closing area.

If someone is trapped:

- Press the  button on the SmartKey, or
- Press the remote operating switch on the driver's door, or
- Press the closing or locking button on the trunk lid, or
- Pull the trunk lid handle.

HANDS-FREE ACCESS function

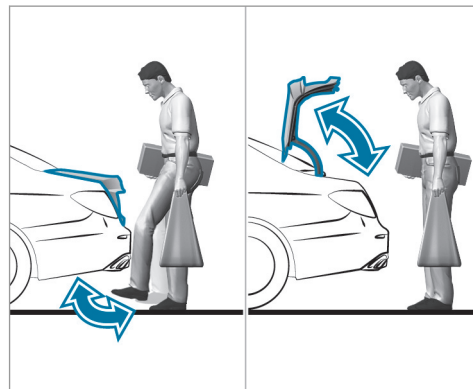

With HANDS-FREE ACCESS you can open, close or stop the opening/closing process of the trunk lid by performing a kicking movement under the bumper.

The kicking movement triggers the opening or closing process alternately.

Observe the notes when opening (→ page 63) and closing (→ page 64) the trunk lid.

- ⓘ A warning tone sounds while the trunk lid is opening or closing.

⚠ WARNING Risk of burns caused by a hot exhaust system

The vehicle exhaust system can become very hot. If you use HANDS-FREE ACCESS, you could burn yourself by touching the exhaust system.

- ▶ Always ensure that you only make a kicking movement within the detection range of the sensors.

! NOTE Damage to the vehicle caused by unintentionally opening the trunk lid

- When using an automatic car wash
- When using a high pressure cleaner
- ▶ Deactivate KEYLESS-GO or make sure that the SmartKey located is at least

10 ft (3 m) away from the vehicle in such situations.

When making the kicking movement, make sure that you are standing firmly on the ground you could otherwise lose your balance, e.g. on ice.

Requirements:

- The SmartKey is behind the vehicle.
- Stand at least 12 in (30 cm) away from the vehicle while performing the kicking movement.
- Do not come into contact with the bumper while making the kicking movement.
- Do not carry out the kicking movement too slowly.
- The kicking movement must be towards the vehicle and back.

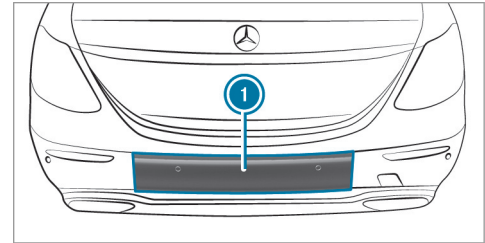

ⓘ Sensor detection range

If several consecutive kicking movements are not successful, wait ten seconds.

System limitations

The system may be impaired or may not function if:

- The area around the sensor is dirty, e.g. road salt.
- The kicking movement is made using a prosthetic leg.

The trunk lid could thus be opened or closed unintentionally in the following situations:

- If persons move arms or legs in the sensor detection range, e.g. when polishing the vehicle, sitting on the edge of the trunk, or picking up objects.
- If objects are guided behind or placed behind the vehicle, e.g. charging cables, tensioning straps or luggage.
- When working on the trailer coupling, on trailers or rear bicycle racks.

Deactivate KEYLESS-GO (→ page 56) or do not carry the SmartKey about your person in such situations.

Switching separate trunk locking on/off

If you centrally unlock the vehicle while separate locking is activated, the trunk remains locked.

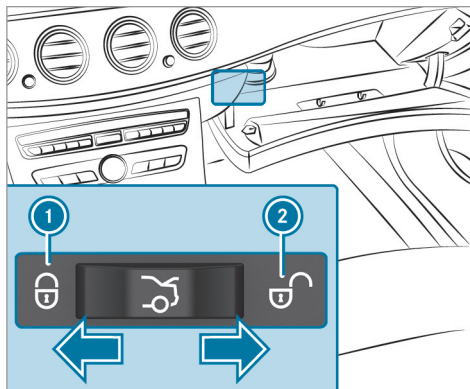

- ▶ **To switch on:** slide the switch to position ①.
 - ▶ **To switch off:** slide the switch to position ②.
- ⓘ If an accident has been detected, the trunk unlocks even if separate locking is switched on.

Unlocking the trunk from inside with the emergency release

Prerequisites

The 12 V vehicle battery is connected and charged.

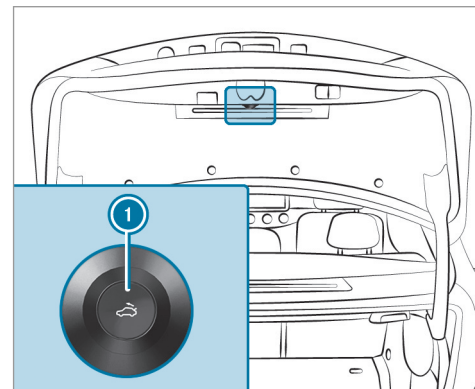

- ▶ Press emergency release button ① briefly. The trunk lid is unlocked and opens.

Activating/deactivating the trunk lid opening limiter

Multimedia system:

↳ Vehicle ▶ Vehicle Settings ▶ Trunk Lid Restriction

Activating the function allows you to avoid bumping the trunk lid on a low garage ceiling, for example.

▶ Activate or deactivate the function.

Roller sun blinds

Extending the rear side window roller sun blinds

! **NOTE** Damage to the inertia reel due to it snapping back

If suddenly snapped back, the inertia reel may be damaged.

▶ Always move the roller sun blind by hand.

▶ Do not drive with the roller sun blind hooked in and side windows opened at the same time.

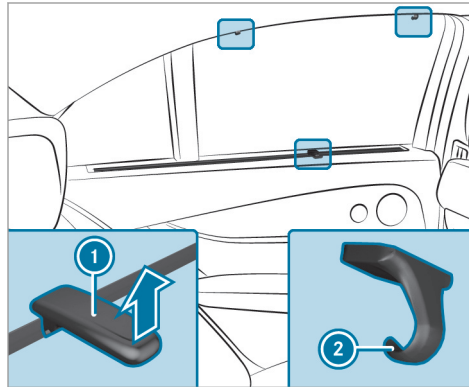

▶ Pull the roller sun blind out by tab ① and hook it onto brackets ②.

Extending or retracting the rear window roller sun blind

! **WARNING** Risk of entrapment when extending or retracting the roller sun blind

Body parts could become entrapped in the sweep of the roller sun blind when it is being extended or retracted.

- ▶ Make sure that no body parts are in the sweep of the roller sun blind when it is being extended or retracted.
- ▶ If someone becomes trapped, briefly press the button again. The opening or closing process is briefly stopped. The roller sun blind then returns to its starting position.

! **NOTE** Damage caused by objects

▶ Make sure that the roller sun blind can move freely.

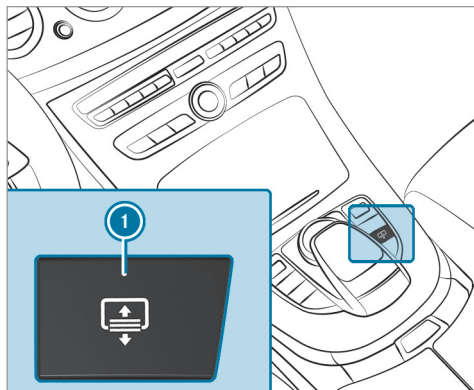

▶ **To extend or retract:** press button ①.

Side windows

Opening/closing the side windows

⚠ WARNING Risk of entrapment when opening a side window

When opening a side window, parts of the body could be drawn in or become trapped between the side window and window frame.

- ▶ When opening, make sure that nobody is touching the side window.
- ▶ If someone is trapped, release the button immediately or pull it in order to close the side window again.

⚠ WARNING Risk of becoming trapped when closing a side window

When closing a side window, body parts could be trapped in the closing area in the process.

- ▶ When closing, make sure that no body parts are in the closing area.

- ▶ If someone is trapped, release the button immediately or press the button in order to reopen the side window.

⚠ WARNING Risk of becoming trapped when children operate the side windows

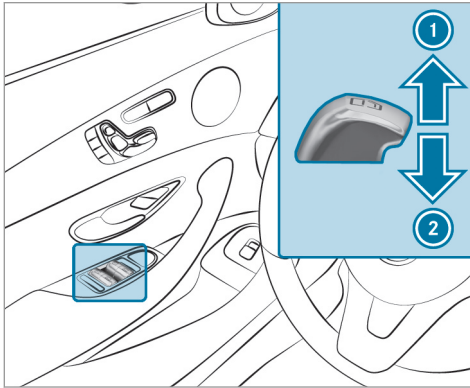

Children could become trapped if they operate the side windows, particularly when unattended.

- ▶ Activate the child safety lock for the rear side windows.
- ▶ When leaving the vehicle, always take the SmartKey with you and lock the vehicle.
- ▶ Never leave children unattended in the vehicle.



- ① To close
- ② To open

The buttons in the driver's door take precedence.

- ▶ **To start automatic operation:** press/pull the  button beyond the pressure point.
- ▶ **To interrupt automatic operation:** press or pull the  button again.

Automatic reversing function for the side windows

If an object blocks a side window during the automatic closing process, the side window opens again automatically. The automatic reversing function is only an aid and is not a substitute for your attentiveness.

- ▶ When closing, make sure that no body parts are in the closing area.

⚠ WARNING Risk of becoming trapped despite reversing protection on the side window

The reversing function does not react:

- To soft, light and thin objects, e.g. small fingers.
- Over the last $\frac{1}{6}$ (4 mm) of the closing movement.
- During resetting.
- When closing the side window again manually immediately after automatic reversing.

This means that the reversing function cannot prevent someone from being trapped in these situations.

- ▶ When closing, make sure that no body parts are in the closing area.
- ▶ If someone becomes trapped, press the  button to open the side window again.

Ventilating the vehicle before starting a journey (convenience opening)

⚠ WARNING Risk of entrapment when opening a side window

When opening a side window, parts of the body could be drawn in or become trapped between the side window and window frame.

- ▶ When opening, make sure that nobody is touching the side window.
- ▶ Release the button immediately if somebody becomes trapped.

▶ Press and hold the  button on the SmartKey.

The following functions are performed:

- The vehicle is unlocked.
- The side windows are opened.
- The sliding sunroof is opened.
- The roller sun blinds and then the panoramic sliding sunroof are opened.
- The seat ventilation of the driver's seat is switched on.

▶ **To interrupt convenience opening:** release the .

Closing side windows from the outside (convenience closing)

⚠ WARNING Risk of entrapment caused by inadvertent convenience closing

When the convenience closing feature is operating, parts of the body could become trapped in the closing area of the side window and the sliding sunroof.

- ▶ Observe the complete closing procedure when using convenience closing.
- ▶ When closing, make sure that no body parts are in the closing area.

▶ Press and hold the  button on the SmartKey.

The following functions are performed:

- The vehicle is locked.
- The side windows are closed.
- The sliding sunroof is closed.
- The panoramic sliding sunroof and then the roller sun blinds are closed.

▶ **To interrupt convenience closing:** release the .

i Tips:

- Convenience closing can also be operated with KEYLESS-GO (→ page 60).

Problems with the side windows

Problem	Possible causes/consequences and ▶ Solutions
A side window cannot be closed and you cannot see the cause.	▶ Check to see if any objects are in the window guide.

Problem**Possible causes/consequences and ► Solutions**

⚠ WARNING Risk of entrapment if reversing protection is not activated

If you close a side window again immediately after it has been blocked or reset, the side window closes with increased or maximum force. The reversing function is then not active.

Parts of the body could be trapped in the closing area in the process.

- Make sure that no parts of the body are in the closing area.
- To stop the closing process, release the button or press the button again to reopen the side window.

If a side window is obstructed during closing and reopens again slightly:

- Immediately after the window blocks, pull the corresponding button again until the side window has closed, and hold the button for an additional second.
The side window is closed with increased force.

If a side window is obstructed again during closing and reopens again slightly:

- Repeat the previous step.
The side window is closed without the automatic reversing function.

Sliding sunroof

Opening/closing the sliding sunroof

- ❗ The term "sliding sunroof" also refers to the panoramic sliding sunroof.

⚠ WARNING Risk of becoming trapped while opening and closing the sliding sunroof

During opening and closing, parts of the body could get caught in the sweep of the sliding sunroof.

- ▶ When opening or closing, make sure that no body parts are in the sweep.
- ▶ Release the button immediately if somebody becomes trapped.

or

- ▶ Press the button in any direction during the automatic opening/closing process. The opening/closing process is stopped.

⚠ WARNING Risk of becoming trapped if the sliding sunroof is operated by children

Children operating the sliding sunroof could get caught in the moving parts, particularly if unattended.

- ▶ Never leave children unattended in the vehicle.
- ▶ When leaving the vehicle, always take the key with you and lock the vehicle.

⚠ WARNING Risk of becoming trapped while opening and closing the roller sun blind

When opening or closing, make sure that no body parts become trapped between the roller sun blind and frame or the sliding sunroof.

- ▶ When opening or closing, make sure that no body parts are in the sweep of the roller sun blind.

- ▶ Release the button immediately if somebody becomes trapped.

or

- ▶ Press the button in any direction during the automatic opening/closing process. The opening/closing process is stopped.

! NOTE Malfunction caused by snow and ice

Snow and ice may lead to a malfunction of the sliding sunroof.

- ▶ Only open the sliding sunroof if it is free of snow and ice.

! NOTE Damage caused by protruding objects

Objects that protrude from the sliding sunroof may damage the sealing strips.

- ▶ Do not allow anything to protrude from the sliding sunroof.

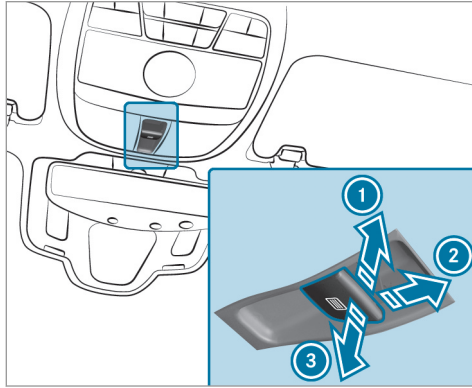



- ① To raise
- ② To open
- ③ To close/lower

Use the  button to operate the sliding sunroof and the roller sun blind.

- The panoramic sliding sunroof can only be opened when the roller sun blind is open.

- The roller sun blind can only be operated when the sliding sunroof is closed.

- ▶ **To start automatic operation:** press/pull the  button beyond the pressure point.
- ▶ **To interrupt automatic operation:** press or pull the  button again.

Restrictions:

- Vehicles without a panoramic sliding sunroof:** The automatic opening and raising feature is available only when the sliding sunroof is closed.
- Vehicles with a panoramic sliding sunroof:** The automatic raising feature is only available when the sliding sunroof is closed or raised.
- The panoramic sliding sunroof cannot be opened if a roof rack is installed. The panoramic sliding sunroof closes again automatically when it encounters resistance.

Automatic reversing function of the sliding sunroof

If there is an object obstructing the sliding sunroof during the closing process, the sliding sun-

roof opens again automatically. The automatic reversing function is only an aid and is not a substitute for your attentiveness.

- ▶ When closing, make sure that no body parts are in the closing area.

⚠ WARNING Risk of becoming trapped despite the reversing function being active

The reversing function does not react:

- to soft, light and thin objects, e. g. small fingers
- during the last 1/6 in (4 mm) of the closing path
- during resetting
- when closing the sliding sunroof again manually immediately after automatic reversing

This means that the reversing function cannot prevent someone being trapped in these situations.

- ▶ When closing, make sure that no body parts are in the closing area.
 - ▶ Release the button immediately if somebody becomes trapped.
- or
- ▶ Press the button in any direction during the automatic closing process. The closing process is stopped.

Automatic reversing function of the roller sun blind

If there is an object obstructing the roller sun blind during the closing process, the roller sun blind opens again automatically. The automatic reversing function is only an aid and is not a substitute for your attentiveness.

- ▶ When opening or closing the roller sun blind, make sure that no body parts are in the sweep.

⚠ WARNING Risk of becoming trapped despite the reversing function being active

In particular, the reversing function does not react to soft, light and thin objects, for example small fingers.

This means that the reversing function cannot prevent entrapment in these situations.

- ▶ When opening or closing the roller sun blind, make sure that no body parts are in the sweep.
 - ▶ Release the button immediately if somebody becomes trapped.
- or
- ▶ Press the button in any direction during the automatic closing process. The closing process is stopped.

Automatic features of the sliding sunroof

- ① The term "sliding sunroof" also refers to the panoramic sliding sunroof.

By pushing or pulling the  button you can interrupt the automatic functions: "Rain closing function when driving" and "Automatic lowering feature".

Rain closing function when driving

Vehicles with a panoramic sliding sunroof: If it starts to rain, the raised sliding sunroof is automatically lowered while the vehicle is in motion.

Automatic lowering feature

Vehicles with a panoramic sliding sunroof: If the sliding sunroof is raised at the rear, the sliding sunroof is automatically lowered slightly at higher speeds. At low speeds it is raised again automatically.

⚠ WARNING Risk of entrapment by automatic lowering of the sliding sunroof

At high speeds the raised sliding sunroof automatically lowers slightly at the rear.

This could trap you or other persons.

- ▶ Make sure that nobody reaches into the sweep of the sliding sunroof whilst the vehicle is in motion.
- ▶ If somebody becomes trapped, immediately pull back the sliding sunroof button.
The sliding sunroof lifts during opening.

Problems with the sliding sunroof

- ❗ The term "sliding sunroof" also refers to the panoramic sliding sunroof.

Problem

The sliding sunroof cannot be closed and you cannot see the cause.

Possible causes/consequences and ► Solutions

⚠ **WARNING** Risk of becoming trapped by closing the sliding sunroof again

If you close the sliding sunroof again immediately after it has been blocked or reset, the sliding sunroof closes with increased or maximum force.







The reversing function is then not active. Parts of the body could be trapped in the closing area in the process. This poses an increased risk of injury or even fatal injury.

- ▶ Make sure that no parts of the body are in the closing area.
- ▶ Release the button immediately if somebody becomes trapped.

or

- ▶ Press the button in any direction during the automatic closing process.
The closing process is stopped.

If the sliding sunroof is obstructed during closing and reopens again slightly:

Problem	Possible causes/consequences and ► Solutions
	<ul style="list-style-type: none"> ► Immediately after automatic reversing, pull the  button down again to the point of resistance until the sliding sunroof is closed. The sliding sunroof is closed with increased force. <p>If the sliding sunroof is obstructed again during closing and reopens again slightly:</p> <ul style="list-style-type: none"> ► Repeat the previous step. The sliding sunroof is closed again with increased force.
<p>Vehicles without a panoramic sliding sunroof: The sliding sunroof does not operate smoothly.</p>	<ul style="list-style-type: none"> ► Raise the sliding sunroof fully at the rear. ► Press the  button for another second. ► Use automatic operation to fully raise and then close the sliding sunroof.
<p>Vehicles with a panoramic sliding sunroof: The sliding sunroof or the roller sun blind does not operate smoothly.</p>	<ul style="list-style-type: none"> ► Pull the  button repeatedly to the point of resistance in the direction of arrow until the sliding sunroof is fully closed. ► Pull the  button for another second. ► Pull and hold the  button down until the roller sun blind is completely closed. ► Pull the  button for another second. ► Use automatic operation to fully open and then close the sliding sunroof.

Anti-theft protection

Immobilizer

The immobilizer prevents your vehicle from being started without the correct key.

The immobilizer is automatically activated when the ignition is switched off and deactivated when the ignition is switched on.

When leaving the vehicle, always take the key with you and lock the vehicle. Anyone can start the engine if a valid key has been left inside the vehicle.

- i In the event that the engine cannot be started (yet the starter battery is charged), the system is not operational. Contact an authorized Mercedes-Benz Center or call 1-800-FOR-MERCEdes (in the USA) or 1-800-387-0100 (in Canada).

ATA (anti-theft alarm system)

Function of the ATA system (anti-theft alarm system)

If the ATA system is armed, a visual and audible alarm is triggered in the following situations:

- A door is opened
- The trunk lid is opened
- The engine hood is opened

The ATA system is armed automatically after approximately 10 seconds:

- After locking the vehicle with the SmartKey.
- After locking the vehicle using KEYLESS-GO.

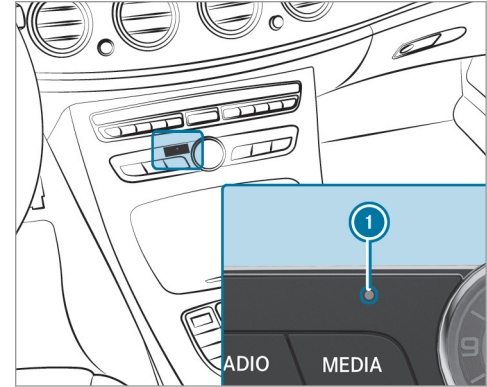

When the ATA system is armed, indicator lamp ① flashes.

The ATA system is automatically deactivated:

- After unlocking the vehicle with the SmartKey.
- After pressing the start/stop button with the SmartKey inside the vehicle.

- After unlocking the vehicle using KEYLESS-GO.
- ① If the mbrace service (→ page 231) is active and the alarm stays on for more than 30 seconds, a message is automatically sent to the Customer Assistance Center.

Deactivating the ATA (anti-theft alarm system) alarm

▶ Press the ,  or  button on the SmartKey.

or

▶ Press the start/stop button on the cockpit (the SmartKey is inside the vehicle).

Stopping the alarm using KEYLESS-GO

▶ Grasp the outside door handle (with the SmartKey outside the vehicle).

Correct driver's seat position

⚠ WARNING Risk of injury from adjusting the vehicle settings while the vehicle is in motion

You could lose control of the vehicle in the following situations:

- if you adjust the driver's seat, the head restraint, the steering wheel or the mirror while the vehicle is in motion
- if you fasten your seat belt while the vehicle is in motion

▶ Before starting the engine: adjust the driver's seat, the head restraint, the steering wheel or the mirror and fasten your seat belt.

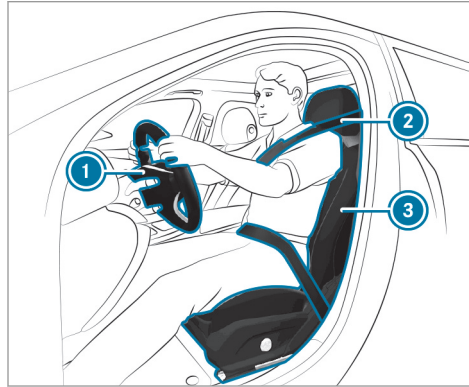

Observe the following when adjusting steering wheel ①, seat belt ② and driver's seat ③:

- You are as far away from the driver's airbag as possible.
- You are sitting in a normal upright position.
- Your thighs are slightly supported by the seat cushion.

- Your legs are not entirely stretched and you can depress the pedals properly.
- The back of your head is supported at eye level by the center of the head restraint.
- You can hold the steering wheel with your arms slightly bent.
- You can move your legs freely.
- You can see all the displays in the instrument cluster clearly.
- You should have a good overview of traffic conditions.
- The seat belt is pulled snugly against the body and must be routed across the center of your shoulder and across your hips in the pelvic area.

Seats

Adjusting the front seat manually and electrically (without Seat Comfort Package)

⚠ WARNING Risk of becoming trapped if the seats are adjusted by children

Children could become trapped if they adjust the seats, particularly when unattended.

- ▶ When leaving the vehicle, always take the SmartKey with you and lock the vehicle.
- ▶ Never leave children unattended in the vehicle.

The seats can still be adjusted when there is no SmartKey in the ignition lock.

⚠ WARNING Risk of becoming trapped when adjusting the seats

When you adjust a seat, you or other vehicle occupants could become trapped, e.g. on the seat guide rail.

- ▶ Make sure when adjusting a seat that no one has any body parts in the sweep of the seat.

Observe the safety notes on "Airbags" and "Children in the vehicle".

⚠ WARNING Risk of accident due to the driver's seat not being engaged

If the driver's seat is not engaged, it could move unexpectedly while the vehicle is in motion.

This could cause you to lose control of the vehicle.

- ▶ Always make sure that the driver's seat is engaged before starting the vehicle.

⚠ WARNING Risk of injury from adjusting the vehicle settings while the vehicle is in motion

You could lose control of the vehicle in the following situations:

- if you adjust the driver's seat, the head restraint, the steering wheel or the mirror while the vehicle is in motion
- if you fasten your seat belt while the vehicle is in motion

- ▶ Before starting the engine: adjust the driver's seat, the head restraint, the steering wheel or the mirror and fasten your seat belt.

⚠ WARNING Risk of becoming trapped if the seat height is adjusted carelessly

If you adjust the seat height carelessly, you or other vehicle occupants could be trapped and thereby injured.

Children in particular could accidentally press the electrical seat adjustment buttons and become trapped.

- ▶ While moving the seats, make sure that hands or other body parts do not get under the lever assembly of the seat adjustment system.

⚠ WARNING Risk of injury due to head restraints which are not installed or are adjusted incorrectly

If head restraints are not installed or are adjusted incorrectly, the head restraints cannot provide protection as intended.

There is an increased risk of injury in the head and neck area, e.g. in the event of an accident or when braking.

- ▶ Always drive with the head restraints installed.
- ▶ Before driving off, make sure for every vehicle occupant that the center of the head restraint supports the back of the head at about eye level.

Do not interchange the head restraints of the front and rear seats. Otherwise, you cannot adjust the height and angle of the head restraints correctly.

Adjust the head restraint fore-and-aft position so that it is as close as possible to the back of your head.

⚠ WARNING Risk of injury due to an incorrect seat position

The seat belt does not offer the intended level of protection if you have not moved the seat backrest to an almost vertical position.

When braking or in the event of an accident, you could slide underneath the seat belt and sustain abdomen or neck injuries, for example. This poses an increased risk of injury or even fatal injury.

- ▶ Adjust the seat correctly before starting the journey.
- ▶ Always ensure that the seat backrest is in an almost vertical position and that the shoulder section of your seat belt is

routed across the center of your shoulder.

! NOTE Damage to the seats when moving the seats back

The seats may be damaged by objects when moving the seats back.

- ▶ When moving the seats back, make sure that there are no objects in the footwell or under or behind the seats.

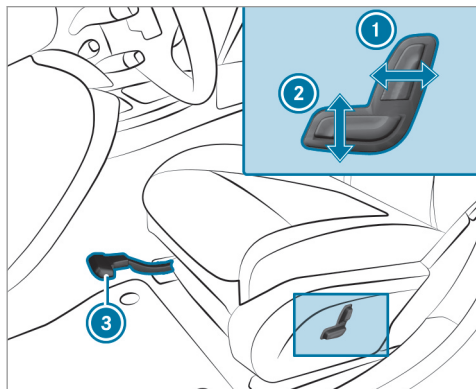

- ① Seat backrest inclination
- ② Seat height
- ③ Seat fore-and-aft position

- ▶ **To adjust the seat fore-and-aft position:** lift lever ③ and slide the seat into the desired position.
- ▶ Make sure that the seat is engaged.

Adjusting the front seat manually and electrically (with Seat Comfort Package)

Observe the safety notes on "Airbags" and "Children in the vehicle".

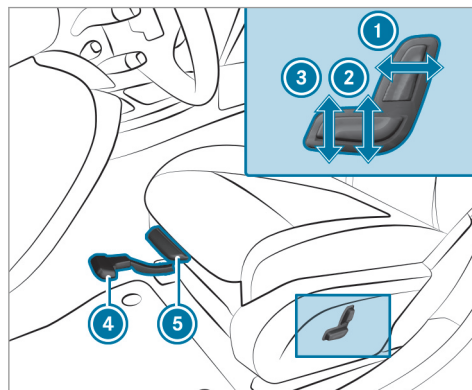

- ① Seat backrest inclination
- ② Seat height
- ③ Seat cushion inclination

- ④ Seat fore-and-aft position
- ⑤ Seat cushion length

- ▶ **To adjust the seat fore-and-aft position:** lift lever ④ and slide the seat forwards or backwards.
- ▶ Make sure that the seat is engaged.
- ▶ **To adjust the seat cushion length:** lift lever ⑤ and slide the front section of the seat cushion forwards or backwards.

Adjusting the seats electrically

The seats can still be adjusted when there is no SmartKey in the ignition lock.

Observe the safety notes on "Airbags" and "Children in the vehicle".

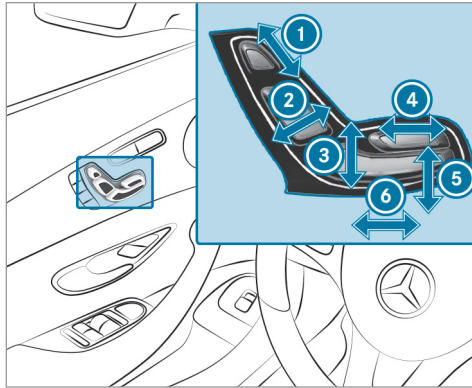

- ① Head restraint height
- ② Seat backrest inclination
- ③ Seat height
- ④ Seat cushion length
- ⑤ Seat cushion inclination
- ⑥ Seat fore-and-aft position

▶ Save the settings with the memory function (→ page 93).

Adjusting the 4-way lumbar support

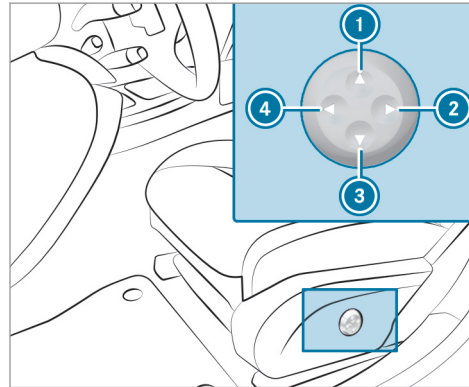

- ① To raise
- ② To soften
- ③ To lower
- ④ To harden

▶ Using buttons ① to ④, adjust the contour of the backrest individually to suit your back.

Head restraints

Adjusting the front seat head restraints manually

⚠ WARNING Risk of injury from adjusting the vehicle settings while the vehicle is in motion

You could lose control of the vehicle in the following situations:

- if you adjust the driver's seat, the head restraint, the steering wheel or the mirror while the vehicle is in motion
- if you fasten your seat belt while the vehicle is in motion

▶ Before starting the engine: adjust the driver's seat, the head restraint, the steering wheel or the mirror and fasten your seat belt.

⚠ WARNING Risk of injury due to head restraints which are not installed or are adjusted incorrectly

If head restraints are not installed or are adjusted incorrectly, the head restraints cannot provide protection as intended.

There is an increased risk of injury in the head and neck area, e.g. in the event of an accident or when braking.

- ▶ Always drive with the head restraints installed.
- ▶ Before driving off, make sure for every vehicle occupant that the center of the head restraint supports the back of the head at about eye level.

Do not interchange the head restraints of the front and rear seats. Otherwise, you cannot adjust the height and angle of the head restraints correctly.

Adjust the head restraint fore-and-aft position so that it is as close as possible to the back of your head.

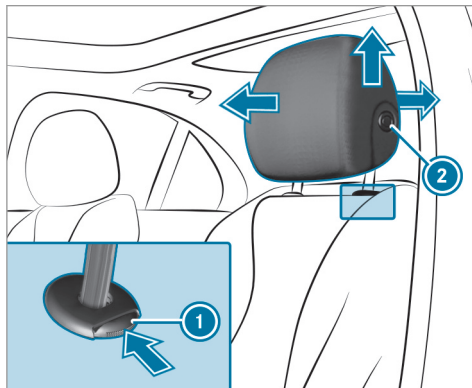

▶ **To raise:** pull the head restraint up.

▶ **To lower:** press release knob ① in the direction of the arrow and push the head restraint down.

Adjusting the gap between the head restraint and the back of your head:

▶ **To move forwards:** pull the head restraint forwards.

▶ **To move backwards:** press release knob ② and push the head restraint backwards.

Adjusting the front seat luxury head restraint manually

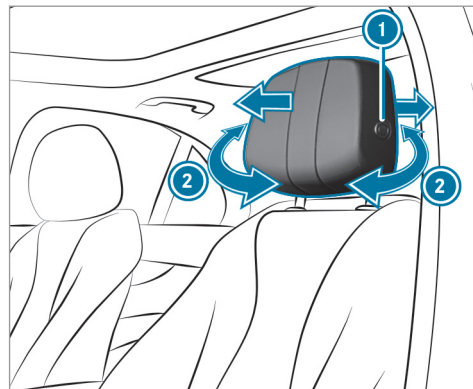

▶ **To adjust the side bolsters of the head restraint:** pull or push the right or left-hand side bolster ②.

Adjusting the gap between the head restraint and the back of your head:

- ▶ **To move forwards:** pull the head restraint forwards.
- ▶ **To move backwards:** press release knob ❶ and push the head restraint backwards.

Adjusting the rear seat head restraints

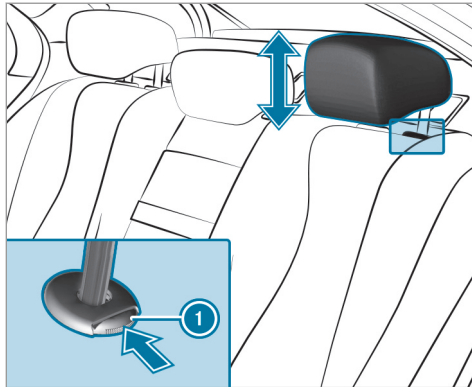

- ▶ **To raise:** pull the head restraint up.
 - ▶ **To lower:** press release knob ❶ in the direction of the arrow and push the head restraint down.
- The head restraints can only be removed on vehicles with folding rear seat backrests.

- ▶ Release the rear seat backrest and fold it slightly forwards.
- ▶ **To remove:** pull the head restraint up to the stop.
- ▶ Push release knob ❶ in the direction of the arrow and pull out the head restraint.
- ▶ **To install:** insert the head restraint so that the notches on the bar are on the left when viewed in the direction of travel.
- ▶ Push the head restraint down until it engages.
- ▶ Fold the rear seat backrest back until it engages.

Configuring seat adjustment

Multimedia system:

↳ Vehicle ▶ Seats

- ▶ Select **Driver's Seat** or **Front Passenger**.

Adjusting the backrest side bolsters

- ▶ Select **Side Bolsters**.
- ▶ Select the setting.

Adjusting the seat contour in the lumbar region of the seat backrest

- ▶ Select **Lumbar**.
- ▶ Adjust the air cushion.

Adjusting the dynamic multicontour seat

Multimedia system:

↳ Vehicle ▶ Seats

The dynamic lateral cornering support can be adjusted using this function.

- ▶ Select **Driver's Seat** or **Front Passenger**.
- ▶ Select **Dynamic Seat**.
- ▶ **Select setting:** **Off**, **Level 1** or **Level 2**.

Overview of massage and workout programs

The following massage programs can be selected:

Massage program for the front seats	Function
Hot Relaxing Massage for back	Relaxing massage program starting in the pelvic area. Warm pressure points can be felt, full back massage, stretching the pelvic area. Ending with gentle stroking motions.
Hot Relaxing Massage for shoulders	Relaxing massage program starting in the shoulder area. Warm pressure points can be felt, full twin-wave back massage, stretching the shoulder area. Ending with gentle stroking motions.
Activating Massage	Activating back massage with increasing twin-waves and then soothing movements.
Classic Massage	Massage with increasing twin-waves and soothing movements.
Wave Massage	Relaxing and activating massage program, starting on your back and continuing in the cushion. Subsequent stroking motions across the entire spinal column.
Mobilizing Massage	Mobilization of the spinal column and upper body using pressure points in the lumbar and back. You can increase the mobilization effect by relaxing into the pressure points. This process helps to improve your posture.

Active Workout programs

The Active Workout programs require your active cooperation and are a convenient way of exercising

your abdomen and back muscles during a traffic jam, for example, by tensing and releasing the specific muscle groups. Tensing and releasing

also helps to improve blood flow in your muscles. Press against a pressure point as soon as you feel it.

Workout program	Function
Active Workout backrest	To stimulate the muscles in your abdomen and back: press against the pressure points in the backrest. Keep the pressure under your feet even. Continue to breathe normally; do not hold your breath. When the pressure in the seat backrest stops, stop pressing against it and relax briefly.
Active Workout cushion	To stimulate the muscles in your lower back: press against the pressure points in the seat cushion. Keep the pressure under your feet even. Continue to breathe normally; do not hold your breath. When the pressure in the seat cushion stops, stop pressing against it and relax briefly.

Selecting the massage program for the front seats

Multimedia system:

↳ Vehicle » Seats

- ▶ Select **Driver's Seat** or **Front Passenger**.
- ▶ Select **Massage**.
- ▶ Select a massage program.
The massage program runs for approximately 15 to 25 minutes, depending on the setting.
- ▶ To set the massage intensity: switch **High Intensity** on or off .

Resetting seat and massage settings

Multimedia system:

↳ Vehicle » Seats » Reset

- ▶ Select **Yes** or **No**.

Depending on whether the settings for the driver or front passenger seat are selected, only the selected seat can be reset.

Switching the seat heater on/off

⚠ WARNING Risk of burns due to repeatedly switching on the seat heater

Repeatedly switching on the seat heater can cause the seat cushion and seat backrest padding to become very hot.

The health of persons with limited temperature sensitivity or a limited ability to react to excessively high temperatures may be affected or they may even suffer burn-like injuries.

- ▶ Do not repeatedly switch on the seat heater.

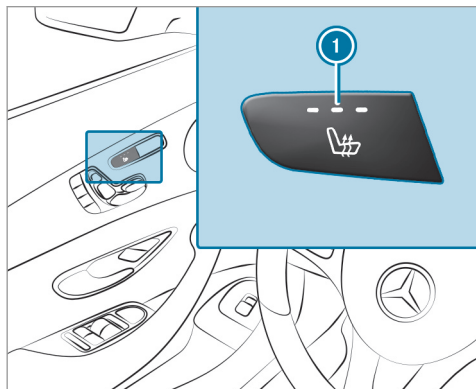

- ▶ **To switch on/increase the level:** press button ❶ repeatedly until the desired heating level is set. Depending on the heating level, up to three indicator lamps light up.
- ▶ **To switch off/reduce the level:** press button ❶ repeatedly until all the indicator lamps go out.

❶ The seat heater automatically switches down from the three heating levels after certain periods of time: 8, 10 and 20 minutes until the seat heater is switched off.

Switching the seat ventilation on/off

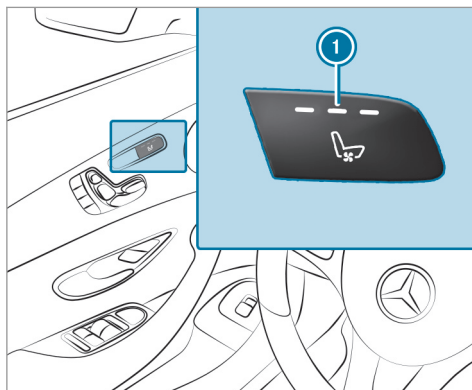

- ▶ **To switch on/increase the level:** press button ❶ repeatedly until the desired ventilation level is set. Depending on the ventilation level, up to three indicator lamps light up.
- ▶ **To switch off/reduce the level:** press button ❶ repeatedly until all the indicator lamps go out.

Steering wheel

Adjusting the steering wheel manually

⚠ WARNING Risk of injury from adjusting the vehicle settings while the vehicle is in motion

You could lose control of the vehicle in the following situations:

- if you adjust the driver's seat, the head restraint, the steering wheel or the mirror while the vehicle is in motion
- if you fasten your seat belt while the vehicle is in motion

- ▶ Before starting the engine: adjust the driver's seat, the head restraint, the steering wheel or the mirror and fasten your seat belt.

⚠ WARNING Risk of entrapment for children when adjusting the steering wheel

Children could injure themselves if they adjust the steering wheel.

- ▶ Never leave children unattended in the vehicle.
- ▶ When leaving the vehicle, always take the key with you and lock the vehicle.

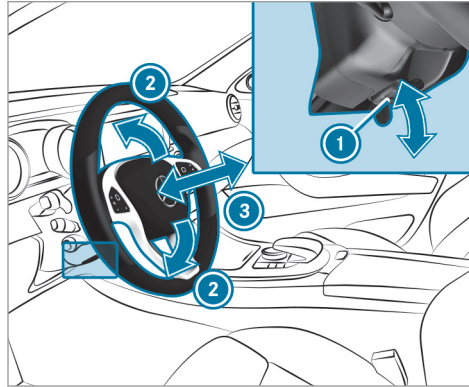

- ▶ To unlock the steering column: push release lever ① down completely.
- ▶ Adjust height ② and distance to steering wheel ③.
- ▶ To lock the steering column: push release lever ① up as far as it will go.
- ▶ Check and ensure that the steering column is locked by moving the steering wheel.

Adjusting the steering wheel electrically

The steering wheel can be adjusted when the SmartKey is removed from the ignition lock.

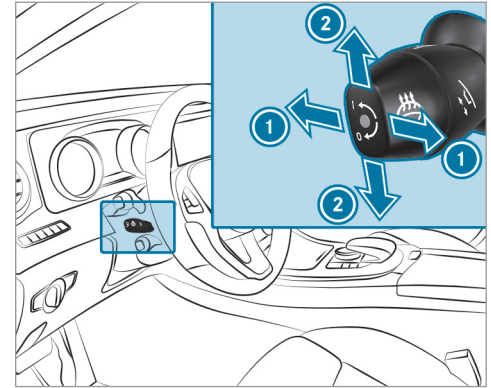

- ① Adjusts the distance to the steering wheel
- ② Adjusts the height
- ▶ Save the settings with the memory function (→ page 93).

Switching the steering wheel heater on/off

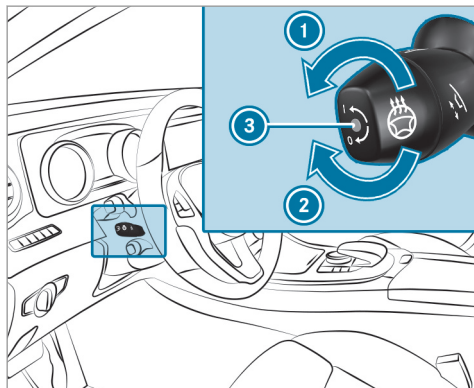

- ① To switch on
- ② To switch off
- ③ Indicator lamp

Easy entry and exit feature

How the easy entry and exit feature operates

⚠ WARNING Risk of accident when driving off while adjusting the easy exit feature

- If you drive off while the easy entry and exit feature is making adjustments, you could lose control of the vehicle.

- ▶ Always wait until the adjustment process is complete before driving off.

⚠ WARNING Risk of entrapment when adjusting the easy entry and exit feature

- When the easy entry and exit feature adjusts the steering wheel, you and other vehicle occupants – particularly children – could become trapped.

- ▶ - While the easy entry and exit feature is making adjustments, make sure that no one has any body parts in the sweep of the steering wheel.

- ▶ Move the adjustment lever of the steering wheel if there is a risk of becoming trapped by the steering wheel. The adjustment process is stopped.
- ▶ Never leave children unattended in the vehicle.
- ▶ When leaving the vehicle, always take the key with you and lock the vehicle.

The easy entry and exit feature makes getting in and out of your vehicle easier.

If the easy entry and exit feature is active, the steering wheel will move upwards in the following situations:

- if you remove the SmartKey from the ignition lock.
- if you open the driver's door when the ignition is switched on.

The steering wheel moves back to the last drive position in the following cases:

- if you insert the SmartKey into the ignition lock when the driver's door is closed.

- if you close the driver's door when the ignition is switched on.

The last drive position of the steering wheel is saved:

- when you switch off the ignition.
- using the last setting stored using the memory function.

If you press one of the memory function position buttons, the adjustment process is stopped.

The crash-responsive exit aid only functions when the easy entry and exit feature is active.

Setting the easy entry and exit feature

Multimedia system:

↳ [Vehicle](#) » [Vehicle Settings](#) » [Easy Entry/Exit](#)

▶ Activate or deactivate the function.

Using the memory function

⚠ WARNING Risk of an accident if memory function is used while driving

If you use the memory function on the driver's side while driving, you could lose control of the vehicle as a result of the adjustments being made.

- ▶ Only use the memory function on the driver's side when the vehicle is stationary.

⚠ WARNING Risk of entrapment when setting the seat with the memory function

When the memory function adjusts the seat or steering wheel, you and other vehicle occupants – particularly children – could become trapped.

- ▶ During the setting procedure of the memory function, ensure that no body parts are in the sweep of the seat or the steering wheel.

- ▶ If somebody becomes trapped, immediately release the memory function position button.
The adjustment process is stopped.

⚠ WARNING Risk of entrapment if the memory function is activated by children

Children could become trapped if they activate the memory function, particularly when unattended.

- ▶ Never leave children unattended in the vehicle.
- ▶ When leaving the vehicle, always take the key with you and lock the vehicle.

The memory function can be used even when the key has been removed.

Driver-seat comfort positions for up to three people can be stored and called up using the memory function.

The following systems can be operated using the memory function:

- Seat, backrest and head restraint

- Steering wheel
- Outside mirrors
- Head-up Display

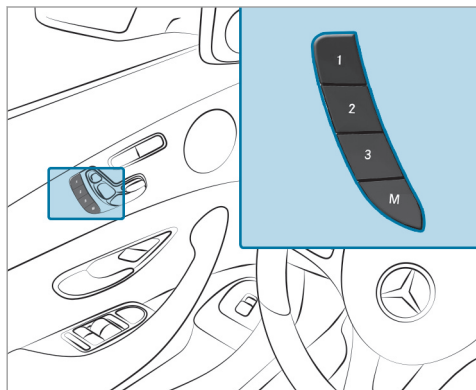

▶ **To save:** set the seat, the steering wheel, the Head-up Display and the outside mirror to the desired position.

- ▶ Press the memory button M together with one of the storage position buttons 1, 2 or 3. The settings are stored. An acknowledgment tone sounds.
- ▶ **To call up:** press and hold button 1, 2 or 3 until all the driver-seat comfort systems are in the stored position.

Stowage areas

Notes on loading the vehicle

⚠ WARNING Risk of exhaust gas poisoning

Combustion engines emit poisonous exhaust gases such as carbon monoxide. Exhaust gases can enter the vehicle interior if the trunk lid is open when the engine is running, especially if the vehicle is in motion.

- ▶ Always switch off the engine before opening the trunk lid.
- ▶ Never drive with the trunk lid open.

⚠ WARNING Risk of injury from unsecured items in the vehicle

If objects are not secured or not secured sufficiently, they could slip, tip over or be thrown around; this could result in vehicle occupants being hit. This also applies to:

- Luggage or loads
- Seats that have been removed and are transported in the vehicle as an exception.

There is a risk of injury, particularly in the event of sudden braking or a sudden change in direction.

- ▶ Always stow objects in such a way that they cannot be thrown around.
- ▶ Before the journey, secure objects, luggage or loads against slipping or tipping over.
- ▶ If a seat has been removed, preferably store the seat outside of the vehicle.

⚠ WARNING Risk of injury from incorrectly stowed objects

If objects in the vehicle interior are stowed incorrectly, they can slide or be thrown around and hit vehicle occupants. In addition, cup holders, open stowage spaces and mobile phone brackets cannot always retain all objects they contain.

There is a risk of injury, particularly in the event of sudden braking or a sudden change in direction.

- ▶ Always stow objects so that they cannot be thrown around in such situations.
- ▶ Always make sure that objects do not protrude from stowage spaces, luggage nets or stowage nets.
- ▶ Close the lockable stowage spaces before starting a journey.
- ▶ Always stow and secure heavy, hard, pointed, sharp-edged, fragile or bulky objects in the trunk.

⚠ WARNING Risk of burns from tailpipes and tailpipe trim

The tailpipe and tailpipe trim can become very hot. If you come into contact with these parts of the vehicle, you could burn yourself.

- ▶ Always be particularly careful around the tailpipe and the tailpipe trim.
- ▶ Allow the vehicle parts to cool down before you touch them.

The handling characteristics of your vehicle are dependent on the distribution of the load within the vehicle. You should bear the following in mind when loading the vehicle:

- never exceed the maximum permissible gross mass or the gross axle weight rating for the vehicle (including occupants). The values are specified on the vehicle identification plate on the vehicle's B-pillar.
- the load must not protrude above the upper edge of the seat backrests.
- always place the load behind unoccupied seats if possible.

- secure the load using the tie-down eyes and distribute the load evenly.

Interior stowage compartments

Overview of the front stowage compartments

Observe the notes on loading the vehicle (→ page 94).

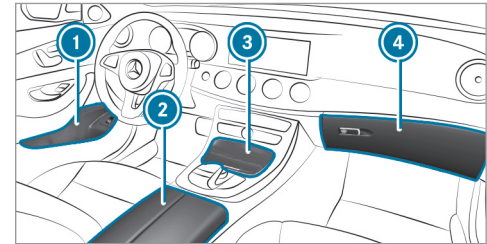

- ① Stowage compartment in the doors
- ② Stowage/telephone compartment in the armrest with multimedia connections and stowage compartment, e.g. for an MP3 player

- ③ Stowage compartment in the front center console with a USB port (depending on the vehicle's equipment)
- ④ Glove box

Locking/unlocking the glove box

Observe the notes on loading the vehicle (→ page 94).

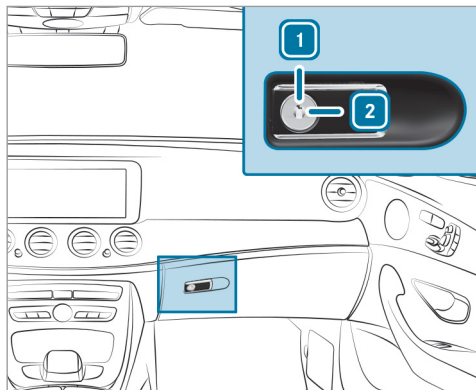

- ▶ Turn the emergency key a quarter turn clockwise ② (to lock) or counter-clockwise ① (to unlock).

Opening the eyeglasses box

Observe the notes on loading the vehicle (→ page 94).

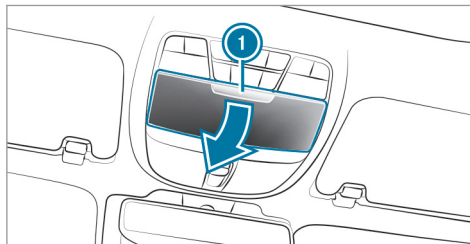

- ▶ **To open:** press button ①.

Opening the stowage compartment in the rear armrest

Observe the notes on loading the vehicle (→ page 94).

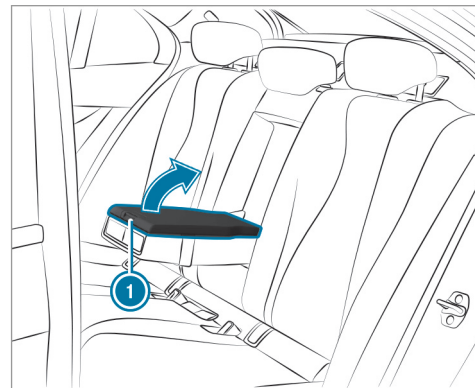

- ▶ **To open:** press release catch ① and swing the cover of the armrest upwards.

Through-loading feature in the rear bench seat

Folding the rear seat backrest forwards

⚠ WARNING Risk of injury if the rear bench seat/rear seat and seat backrest are not engaged

If the rear bench seat/rear seat and seat backrest are not engaged they could fold forwards, e.g. when braking suddenly or in the event of an accident.

- If this is the case, the vehicle occupant would be forced into the seat belt by the rear bench seat/rear seat or by the seat backrest. The seat belt cannot protect as intended and could result in additional injury.
 - Objects or loads in the trunk cannot be restrained by the seat backrest.
- ▶ Make sure that the seat backrest and the rear bench seat/rear seat are engaged before every trip.

If the rear seat backrest is not engaged and locked, this will be shown in the multifunction display in the instrument cluster.

The center and outer seat backrests can be folded forwards separately.

- ▶ Fully insert the rear seat backrest head restraints.

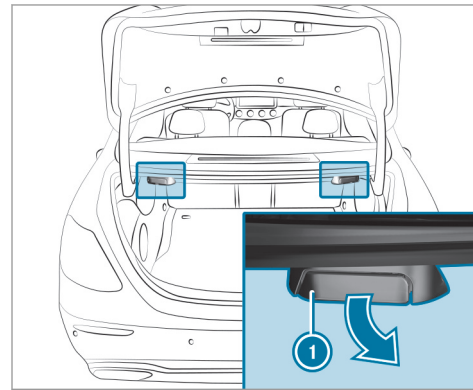

- ▶ **Left and right seat backrest:** pull release lever **1**.

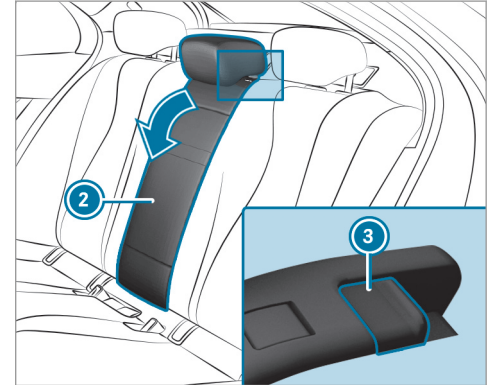

- ▶ **Center seat backrest:** pull seat backrest release **2** forwards.
- ▶ Fold the corresponding seat backrest forwards.

Folding the rear seat backrest back

1 NOTE Damage to the seat belt

The seat belt could become trapped and thus damaged when folding back the seat backrest.

- ▶ Make sure that the seat belt is not trapped when folding back the seat backrest.

If the rear seat backrest is not engaged and locked, this will be shown in the multifunction display in the instrument cluster.

- ▶ Move the driver's or front passenger seat forwards, if necessary.

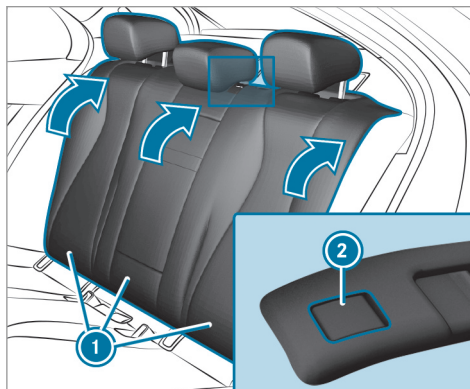

- ▶ Fold corresponding seat backrest **1** back until it engages.

Left and right seat backrests: if the seat backrest is not correctly engaged, this will be shown in the multifunction display in the instrument cluster.

Center seat backrest: if the seat backrest is not correctly engaged, red lock verification indicator **2** will be visible.

Locking the center rear seat backrest

Lock the center seat backrest if you want to secure the load compartment from unauthorized access. The center seat backrest can then only be folded forwards together with the left seat backrest.

Both seat backrests must be engaged and joined together.

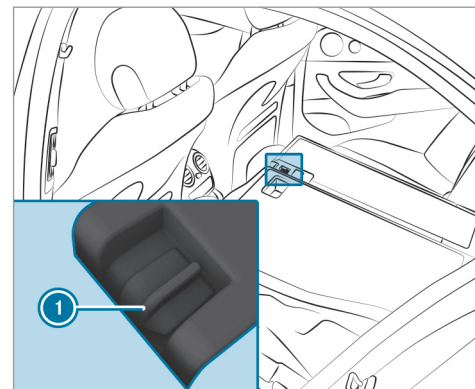

- ▶ Fold the center and left seat backrest forwards.
- ▶ **To lock:** slide catch ❶ upwards. The release mechanism of the center seat backrest is locked.
- ▶ **To unlock:** slide catch ❶ downwards.

Overview of the tie-down eyes

Observe the notes on loading the vehicle (→ page 94).

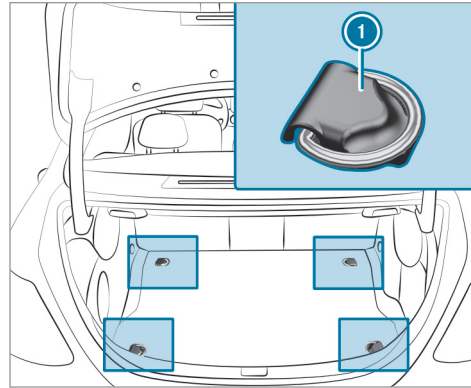

- ❶ Tie-down eyes (vehicles with through-loading feature in the rear bench seat)

EASY-PACK trunk box

Adjusting the height of the EASY-PACK trunk box to any position

⚠ WARNING Risk of becoming trapped and injured when moving the floor up

When the floor moves up, your hands may become trapped on the frame of the EASY-PACK trunk box and objects may be thrown up.

- ▶ When the floor moves up, make sure that your hands are not within the sweep of the floor.
- ▶ If someone becomes trapped, carefully push the center of the floor downward.
- ▶ Remove all objects from the floor before moving it up.

⚠ WARNING Risk of becoming trapped when pressing the EASY-PACK trunk box in

When the EASY-PACK trunk box is pressed into the retracted position, your hands may become trapped. Children, in particular, may injure themselves when doing so.

- ▶ When pressing the EASY-PACK trunk box in, make sure that your hands are not within the sweep of the EASY-PACK trunk box.
- ▶ When leaving the vehicle, always take the SmartKey with you and lock the vehicle.
- ▶ Never leave children unattended in the vehicle.

! NOTE Damage to the extended EASY-PACK trunk box

The EASY-PACK trunk box may be damaged when the EASY-PACK trunk box is extended.

▶ Do not place any objects on or press down on the EASY-PACK trunk box frame.

▶ Do not close the trunk lid when the EASY-PACK trunk box is extended.

! NOTE Damage to the EASY-PACK trunk box caused by objects which are sharp-edged, pointed, fragile, rounded or heavy and objects that roll

Objects which are sharp-edged, pointed, fragile, rounded or heavy and objects that roll can damage the EASY-PACK trunk box and be thrown out.

- ▶ Do not transport objects which are sharp-edged, pointed, rounded or fragile and objects that roll in the EASY-PACK trunk box.
- ▶ Always stow and secure such objects outside of the box in the trunk.
- ▶ Always observe the maximum permitted load of the EASY-PACK trunk box.

▶ Do not use the EASY-PACK trunk box when the rear seats are folded forwards.

The maximum permitted load of the EASY-PACK trunk box is 22 lbs (10 kg). To prevent the box from being overloaded, the box floor lowers onto the trunk floor when the load reaches approximately 11 lbs (5 kg).

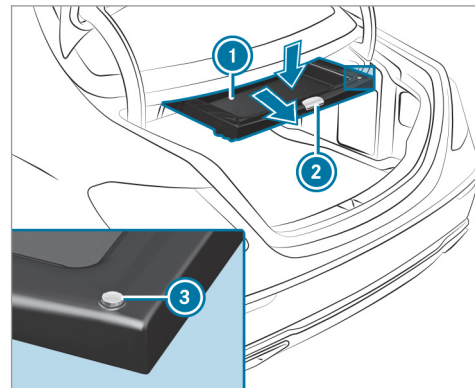

- ▶ Pull the box out using handle ②.
 - ▶ **To increase the load capacity:** press the center of floor ① downward to the desired position and box size.
 - ▶ **To reduce the load capacity:** press button ③.
 - ▶ **To stow:** press the box in completely using handle ②, until it locks in place.
- ⓘ Observe the notes on cleaning the EASY-PACK trunk box (→ page 273).

Installing/removing the EASY-PACK trunk box

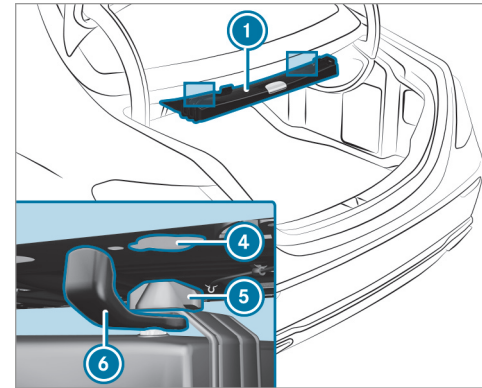
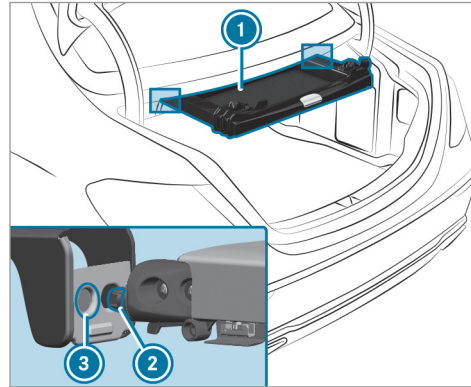

- ▶ **To install:** open rotating catch ⑥ and turn it outwards.
- ▶ Insert brackets ② of box ① into outer holes ③.
- ▶ Raise box ① and press hooks ⑤ into rear shelf ④.
- ▶ Turn rotating catch ⑥ inwards to the stop.

- ▶ **To remove:** turn left-hand rotating catch ⑥ clockwise and right-hand rotating catch ⑥ counter-clockwise by 90°.
- ▶ Lower box ① and pull it out of anchorages ④, then pull box ① backwards and out of holes ③.

Opening the stowage space under the trunk floor

1 NOTE Damage to the handle in the trunk floor

If the handle in the trunk is left protruding, the handle may be damaged.

- ▶ Unhinge the handle before you close the trunk lid and clip it in place.

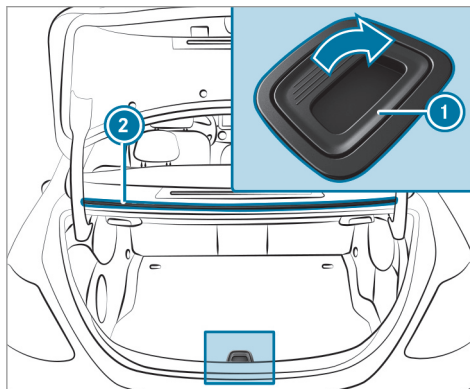

- ▶ Pull handle ① up and hook it into rain trough ②.

Attaching the roof rack

⚠ WARNING Risk of injury by exceeding the maximum roof load

When you load the roof, the vehicle center of gravity rises and the driving characteristics change.

If you exceed the maximum roof load, the driving characteristics, as well as the steering and braking, will be greatly impaired.

- ▶ Never exceed the maximum roof load and adjust your driving style.

You will find information on the maximum roof load in the "Technical data" section.

Prerequisites

- Only use roof racks tested and approved by Mercedes-Benz.
- When the roof rack has been installed, make sure that the sliding sunroof can be fully raised and the trunk lid fully opened.
- Do not open the panoramic sliding sunroof if a roof rack is installed. The panoramic sliding

sunroof closes again automatically when it encounters resistance.

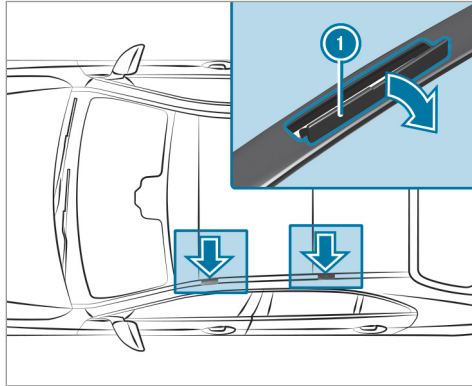

! NOTE Damage to the covers

The covers may be damaged and scratched when being opened.

- ▶ Do not use metallic or hard objects.

- ▶ Fold covers ① carefully upwards in the direction of the arrow.
- ▶ Only secure the roof rack to the anchorage points under covers ①.
- ▶ Always comply with the roof rack manufacturer's installation instructions.
- ▶ Secure the load on the roof rack.

Cup holder

Installing or removing the cup holder in the center console

! WARNING - Risk of accident or injury when using the cup holder while the vehicle is moving

The cup holder cannot secure containers while the vehicle is moving.

If you use a cup holder while the vehicle is moving, the container may be flung around and liquids may be spilled. The vehicle occupants may come into contact with the liquid and if it is hot, they could be scalded. You

could be distracted from traffic conditions and you may lose control of the vehicle.

- ▶ Only use the cup holder when the vehicle is stationary.
- ▶ Only use the cup holder for containers of the right size.
- ▶ Close the container, particularly if the liquid is hot.

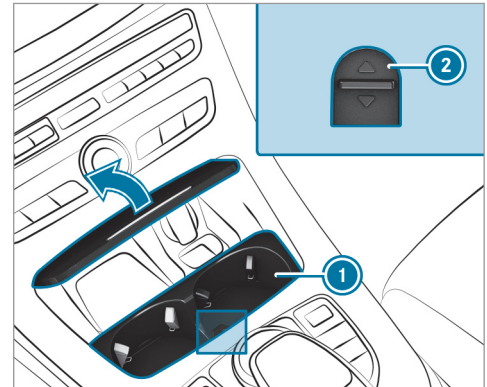

▶ **To remove:** slide catch ② forwards and pull out cup holder ①.

▶ **To install:** insert cup holder ① and slide back catch ②.

ⓘ The rubber mat of the cup holder can be removed for cleaning, e.g. using clean, lukewarm water.

Opening the cup holder in the rear armrest

! **NOTE** Damage to the cup holder

When the rear armrest is folded back the cup holder could become damaged.

▶ Only fold the rear armrest back when the cup holder is closed.

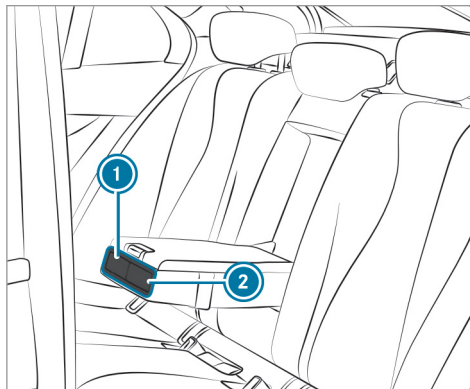

▶ **To open:** press on cup holder ① or ②.

▶ **To fold in or out:** place or remove a container from cup holder ① or ②.

Ashtray and cigarette lighter

Using the ashtray in the front center console

! **NOTE** Damage to the stowage compartment under the ashtray

The stowage compartment under the ashtray is not heat resistant and could be damaged if you rest a lit cigarette on it.

▶ Make sure that the ashtray is fully engaged.

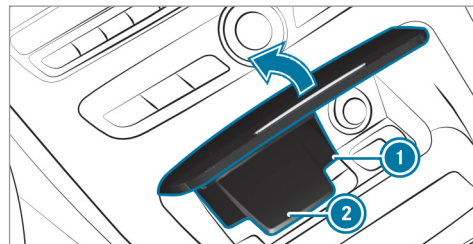

▶ **To open:** push the cover of the ashtray upwards on its right ② or left side.

- ▶ **To remove the insert:** press insert ① upwards slightly and pull it out upwards.
- ▶ **To install the insert:** press insert ① into the holder until the insert engages.

Using the rear passenger compartment ash-tray

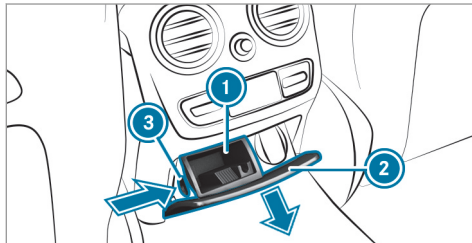

- ▶ **To open:** pull cover ② out by its top handle edge.
- ▶ **To remove the insert:** push ribbing ③ from the left side and pull insert ① upwards and out.

- ▶ **To install the insert:** install insert ① from above and press down into the holder until it engages.

Using the cigarette lighter

⚠ WARNING - Risk of fire and injury from hot cigarette lighter

You can burn yourself if you touch the hot heating element or the socket of the cigarette lighter.

In addition, flammable materials may ignite if:

- you drop the hot cigarette lighter
- a child holds the hot cigarette lighter to objects, for example
 - ▶ Always hold the cigarette lighter by the knob.
 - ▶ Always make sure that the cigarette lighter is out of reach of children.
 - ▶ Never leave children unattended in the vehicle.

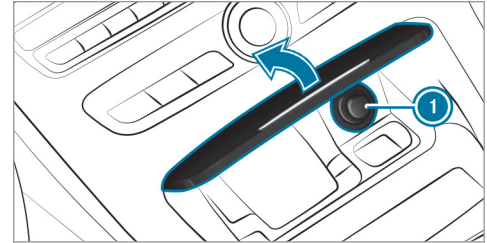

- ▶ Press in cigarette lighter ①. The cigarette lighter will pop out automatically when the heating element is red-hot.

Sockets

Using the 12 V socket in the front center console

Requirements:

- Only connect devices up to a maximum of 180 Watt (15 A)
- If you have connected a device to the 12 V socket, leave the cover of the stowage compartment open

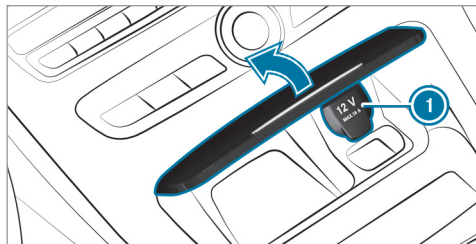

- ▶ Lift out cover ❶ of the socket and insert the plug of the device.

Using the 12 V socket in the rear passenger compartment

Requirement

Only connect devices up to a maximum of 180 watt (15 A)

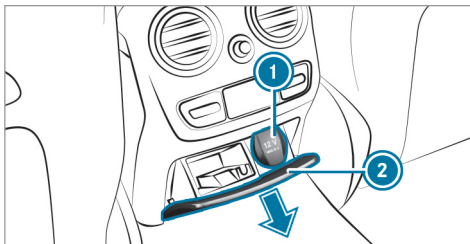

- ▶ Briefly press the trim of cover ❷.
- ▶ Lift out cover ❶ of the socket and insert the plug of the device.

Using the 115 V socket in the rear passenger compartment

⚠ DANGER Risk of fatal injury due to damaged connecting cables or sockets

If a suitable device is connected, the 115 V socket will be carrying a high voltage. If the connecting cable or the 115 V socket is pulled out of the trim or is damaged or wet, you could receive an electric shock.

- ▶ Only use dry and damage-free connecting cables.
- ▶ When the ignition is switched off, ensure that the 115 V socket is dry.
- ▶ If the 115 V socket is damaged or gets pulled out of the paneling, immediately have the socket checked or replaced at a qualified specialized workshop.
- ▶ Never plug the connecting cable into a 115 V socket that is damaged or has been pulled out of the trim.

⚠ DANGER Risk of fatal injury due to incorrect handling of the socket

You could receive an electric shock:

- if you reach into the socket.
- if you insert unsuitable devices or objects into the socket.

If you reach into the power socket or plug unsuitable devices or objects into the socket, you could receive an electric shock.

- ▶ Only connect suitable devices to the socket.

Prerequisites

- Only connect devices with a suitable plug which conforms to the standards specific to the country you are in.
- Only connect devices up to a maximum of 150 watts.
- Do not use multiple socket outlets.

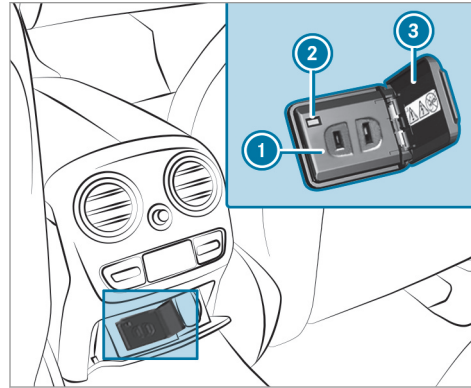

- ▶ Open flap ③.
- ▶ Insert the plug of the device into 115 V socket ①.
When the on-board electrical system voltage is sufficient, indicator lamp ② lights up.

Wireless charging of the mobile phone and connection with the exterior antenna

⚠ WARNING Risk of injury due to objects being stowed incorrectly

If objects in the vehicle interior are stowed incorrectly, they can slide or be thrown around and hit vehicle occupants. In addition, cup holders, open stowage spaces and mobile phone receptacles cannot always retain all objects they contain.

There is a risk of injury, particularly in the event of sudden braking or a sudden change in direction.

- ▶ Always stow objects so that they cannot be thrown around in such situations.
- ▶ Always make sure that objects do not protrude from stowage spaces, luggage nets or stowage nets.
- ▶ Close the lockable stowage spaces before starting a journey.

- ▶ Always stow and secure heavy, hard, pointed, sharp-edged, fragile or bulky objects in the trunk/load compartment.

Observe the notes on loading the vehicle.

⚠ WARNING Risk of fire from placing objects in the mobile phone stowage compartment

If you place objects in the mobile phone stowage compartment, they may heat up excessively and even catch fire.

- ▶ Do not place additional objects, especially those made of metal, in the mobile phone stowage compartment.

! NOTE Damage to objects caused by placing them in the mobile phone stowage compartment

If you place objects in the stowage compartment, these may be damaged by electromagnetic fields.

- ▶ Do not place credit cards, storage media or other objects sensitive to electromagnetic fields in the mobile phone stowage compartment.
- ▶ Do not spill liquids into the mobile phone stowage compartment.

Requirements:

- Your mobile phone must be suitable for wireless charging (Qi-compatible mobile phone).
- Depending on the vehicle equipment, the mobile phone is connected to the vehicle's exterior antenna via the charging module.
- The charging function and wireless connection of the mobile phone to the vehicle's exterior antenna are only available if the ignition is switched on.
- To ensure more efficient charging and connection with the exterior antenna, remove the protective cover from the mobile phone.
- Small mobile phones may not be able to be charged in every position of the stowage compartment.

- Large mobile phones which do not fit into the stowage compartment may not be able to be charged or connected with the exterior antenna.

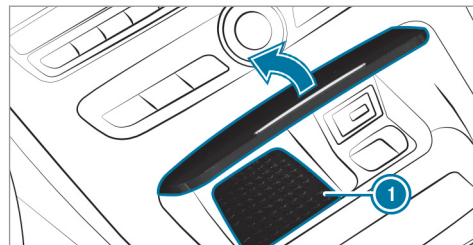

- ▶ Place the mobile phone as close to the center of mat ① as possible with the display facing upwards. The mobile phone is charged automatically, as is apparent from the way in which the mobile phone reacts and from the charging symbol in the multimedia system display. Malfunctions during the charging process are shown in the multimedia system display.

- ⓘ The mobile phone may heat up during the charging process, especially if data services are being used at the same time. For this reason, it is possible to cool the mobile phone depending on the operating status of the air conditioning system. Cooling output depends on the position of the controller for the glove box cooling system (cooling output is higher when the controller is closed).
- ⓘ To clean, mat ① can be removed. If possible, use the mat when charging.

Installing/removing floor mats

⚠ WARNING Risk of accident due to objects in the driver's footwell

Objects in the driver's footwell may impede pedal travel or block a depressed pedal.

This jeopardizes the operating and road safety of the vehicle.

- ▶ Stow all objects in the vehicle securely so that they cannot get into the driver's footwell.

- ▶ Always install the floor mats securely and as prescribed in order to ensure that there is always sufficient room for the pedals.
- ▶ Do not use loose floor mats and do not place floor mats on top of one another.

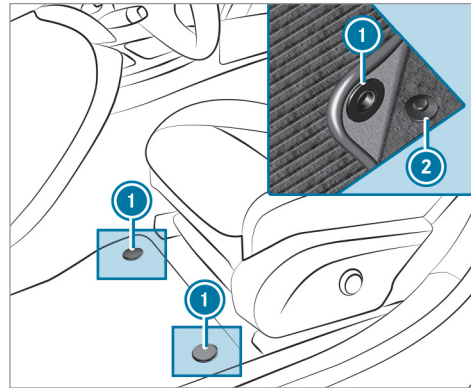

- ▶ **To install:** press studs ① onto holders ②.

- ▶ **To remove:** pull the floor mat off the holders ②.

Exterior lighting

Lighting systems and your responsibility

The various lighting systems of the vehicle are only aids. The driver of the vehicle is responsible for correct vehicle illumination in accordance with the prevailing light and visibility conditions, legal requirements and traffic situation.

Light switch

Operating the light switch

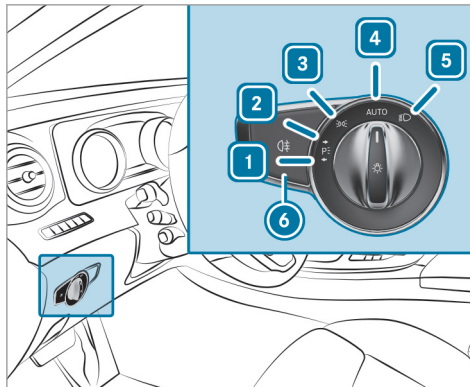

- ▶ 1 Left-hand parking lights
- ▶ 2 Right-hand parking lights
- ▶ 3 Parking lights and license plate lighting

- ▶ 4 **AUTO** Automatic driving lights (preferred light switch position)
- ▶ 5 Low beam/high beam
- ▶ 6 **0F** To activate or deactivate the rear fog light

When the low beam is activated, the indicator lamp for the parking lights is deactivated and replaced by the low beam indicator lamp.

Always park your vehicle safely and in a well-lit area, in accordance with the relevant legal stipulations.

! **NOTE** Battery discharging by operating the standing lights

Operating the standing lights over a period of hours puts a strain on the battery.

- ▶ Where possible, switch on the right or left parking light.

In the case of severe battery discharging, the standing lights or parking lights are automatically switched off to facilitate a future engine start.

The exterior lighting (except standing/parking lights) switches off automatically when the driver's door is opened.

Automatic driving lights

The parking lights, low beam and daytime running lights are switched on automatically depending on the ignition status, whether the engine is running and on the light conditions.

⚠ WARNING Risk of accident when the low beam is switched off in poor visibility

When the light switch is set to **AUTO**, the low beam may not be switched on automatically if there is fog, snow or other causes of poor visibility such as spray.

▶ In such cases, turn the light switch to .

Activating/deactivating the rear fog light

Requirement

The light switch is in the  or **AUTO** position.

▶ Press the  button.

Please observe the country-specific laws on the use of rear fog lamps.

Operating the light combination switch

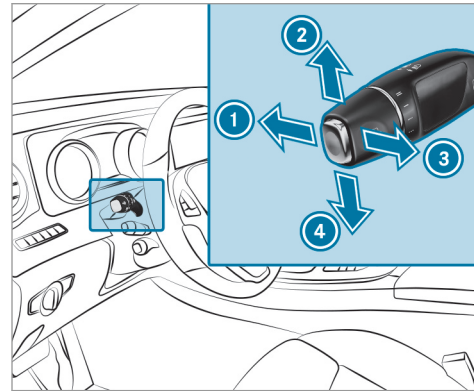

- ① High beam
- ② Turn signal light, right
- ③ Headlamp flashing
- ④ Turn signal light, left

▶ Pull or push the combination switch in the relevant direction following the arrow.

Switching on the high beam manually

▶ **Vehicles with Adaptive Highbeam Assist:**

Turn the light switch to the  position.

Press the combination switch beyond the pressure point in the direction of arrow ①.

When the high beam is activated, the indicator lamp for low beam is deactivated and replaced by the indicator lamp for the high beam.

▶ **To switch off the high beam:** move the combination switch back to its starting position.

▶ **To indicate briefly:** press the combination switch briefly up to the pressure point in the direction of arrow ② or ④. The corresponding turn signal light flashes three times.

▶ **To indicate for a duration:** press the combination switch beyond the pressure point in the direction of arrow ② or ④.

Activating/deactivating the hazard warning light

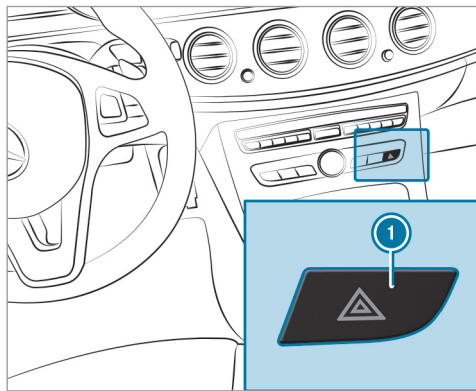

▶ Press button ①.

Cornering light

Cornering light function

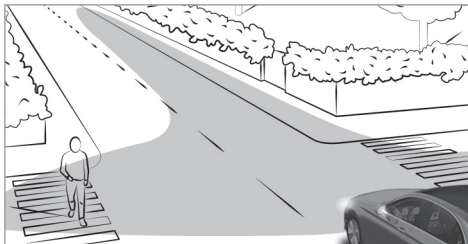

Cornering light improves the illumination of the road over a wide angle in the direction you are turning, enabling better visibility in tight bends, for example. It can only be activated when the low beam is switched on.

The function is active:

- At speeds below 25 mph (40 km/h) when the turn signal light is switched on or the steering wheel is turned.

- At speeds between 25 mph (40 km/h) and 45 mph (70 km/h) when the steering wheel is turned.

Traffic circle and intersection function: the cornering light is activated on both sides through an evaluation of the current GPS position of the vehicle. It remains active until after the vehicle has left the traffic circle or the intersection.

Adaptive Highbeam Assist

Function of Adaptive Highbeam Assist

⚠ WARNING Risk of accident despite Adaptive Highbeam Assist

Adaptive Highbeam Assist does not recognize the following road users:

- Road users without lights, e.g. pedestrians
- Road users with poor lighting, e.g. cyclists
- Road users whose lighting is obstructed, e.g. by a barrier

On very rare occasions, Adaptive Highbeam Assist may fail to recognize other road users with their own lighting, or may recognize them too late.

In these or similar situations, the automatic high beam is not deactivated or is activated despite the presence of other road users.

- ▶ Always observe the traffic carefully and switch off the high beam in good time.

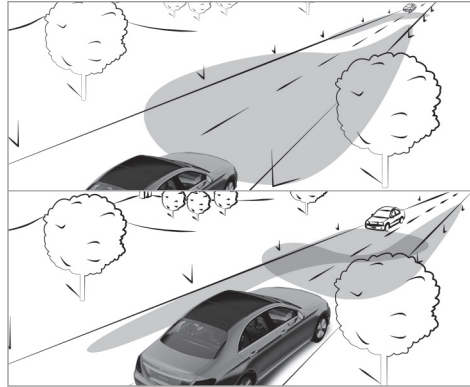

Adaptive Highbeam Assist switches automatically between:

- Low beam
- High beam

At speeds above 19 mph (30 km/h):

- If no other road users are detected, the high beam is automatically switched on.

The high beam switches off automatically:

- At speeds below 16 mph (25 km/h).
- If other road users are detected.
- If street lighting is sufficient.

At speeds above approx. 31 mph (50 km/h):

- The headlamp range of the low beam is regulated automatically based on the distance to other road users.

The system's optical sensor is located behind the windshield near the overhead control panel.

System limitations

Adaptive Highbeam Assist cannot take into account road, weather or traffic conditions.

Detection may be restricted if:

- Visibility is impaired, for example in fog, heavy rain or snow.
- There is dirt on the sensors or if the sensors are covered over.

Switching Adaptive Highbeam Assist on/off

- ▶ **To switch on:** turn the light switch to the **AUTO** position.

- ▶ Switch on the high beam using the combination switch.
When the high beam is switched on automatically in the dark, the  indicator lamp in the multifunction display comes on.
- ▶ **To switch off:** switch off the high beam using the combination switch.

Switching the daytime running lights on/off

Multimedia system:

- ▶  Vehicle ▶  Light Settings
- ▶▶ Daytime Run. Lights
- ▶ Activate or deactivate the function.

Setting the surround lighting

Requirement:

The light switch is in the  position.

Multimedia system:

- ▶  Vehicle ▶  Light Settings
- ▶▶ Locator Lighting

Exterior switch-off delay time: the exterior lighting is switched on for a short time after the vehicle is switched off.

- ▶ Set the switch-off delay time.





Locator lighting: if a switch-off delay time is set, the exterior lighting remains lit for 30 seconds after the vehicle is unlocked. When you start the vehicle, the locator lighting is switched off and automatic driving lights are activated.

Interior lighting

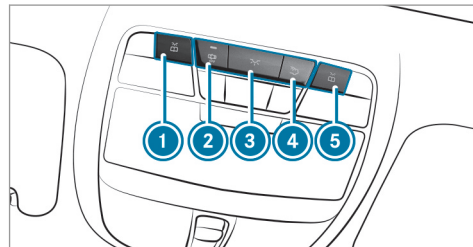
Adjusting the interior lighting

Front overhead control panel



- ▶ ①  Switches the front left-hand reading lamp on/off
- ▶ ②  Switches the automatic interior lighting control on/off
- ▶ ③  Switches the front interior lighting on/off
- ▶ ④  Switches the rear interior lighting on/off

- ▶ **5**  Switches the front right-hand reading lamp on/off

Control panel in the grab handle (rear passenger compartment)

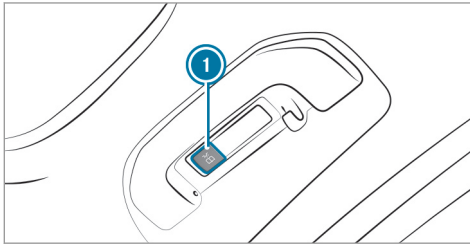

- ▶ **1**  Switches the reading lamp on/off

Adjusting the ambient lighting

Multimedia system:

- ▶ **Vehicle** ▶  Light Settings ▶ Ambient Light

Setting the color

- ▶ Select **Color**.

- ▶ Set the color.

Setting the brightness for zones

- ▶ Select **Entire Vehicle**, **Front**, **Rear** or **Display**.
- ▶ Set the brightness value.

Setting the interior lighting switch-off delay time



Multimedia system:

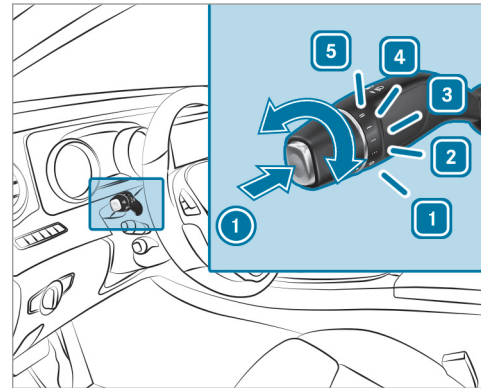

- ▶ **Vehicle** ▶  Light Settings ▶ Int. Light Delay Sw. off
- ▶ Set the switch-off delay time.

Windshield wiper and windshield washer system

Switching the windshield wipers on or off



- ▶ **1**  Single wipe /  wipes the windshield using washer fluid
- ▶ **1** **0** Windshield wipers off
- ▶ **2** **...** Intermittent wiping, normal

- ▶ 3  Intermittent wiping, frequent
- ▶ 4  Continuous wiping, slow
- ▶ 5  Continuous wiping, fast

Replacing the windshield wiper blades

⚠ WARNING Risk of becoming trapped if the windshield wipers are switched on while wiper blades are being replaced

If the windshield wipers begin to move while you are changing the wiper blades, you can be trapped by the wiper arm.

- ▶ Always switch off the windshield wipers and the ignition before changing the wiper blades.

Moving the wiper arms to a vertical position

- ▶ Set the windshield wipers to the  slow continuous wiping position on the combination switch.
- ▶ As soon as the wiper arms are vertical to the engine hood, switch off the ignition.
- ▶ Fold the wiper arm away from the windshield.

Removing the wiper blades

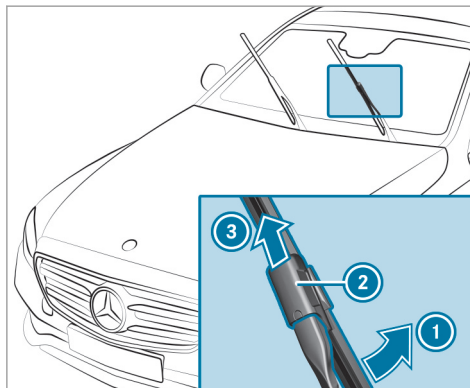

- ▶ Hold the wiper arm with one hand. With the other hand, turn the wiper blade in the direction of arrow ① away from the wiper arm to the stop.
- ▶ Slide catch ② in the direction of arrow ③ until it engages in the removal position.

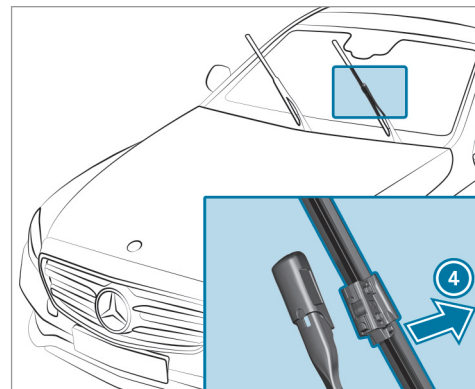

- ▶ Remove the wiper blade in the direction of arrow ④ away from the wiper arm.

Installing the wiper blades

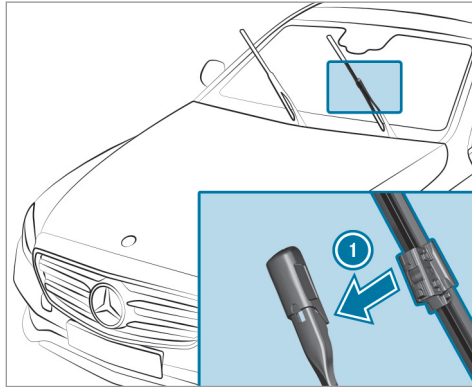

- ▶ Insert the new wiper blade into the wiper arm in the direction of arrow ①.

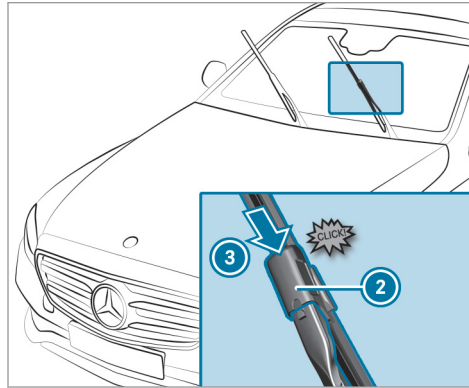

- ▶ Slide catch ② in the direction of arrow ③ until it engages in the locking position.
- ▶ Make sure that the wiper blade sits correctly.
- ▶ Fold the wiper arm back onto the windshield.

Maintenance display

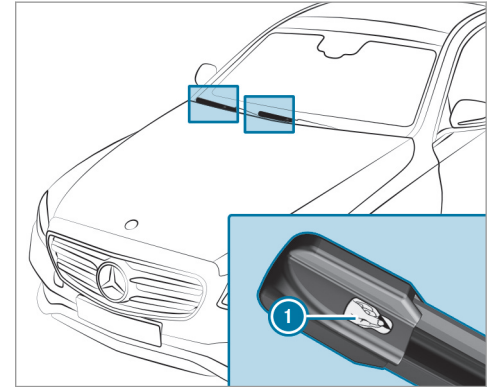

- ▶ Remove protective film ① of the maintenance display on the tip of the newly installed wiper blade.

If the color of the maintenance display changes from black to yellow, the wiper blades should be replaced.

- i The duration of the color change varies depending on the conditions of use.

Mirrors

Operating the outside mirrors

- ⚠ WARNING** Risk of injury from adjusting the vehicle settings while the vehicle is in motion

You could lose control of the vehicle in the following situations:

- if you adjust the driver's seat, the head restraint, the steering wheel or the mirror while the vehicle is in motion
- if you fasten your seat belt while the vehicle is in motion
- ▶ Before starting the engine: adjust the driver's seat, the head restraint, the steering wheel or the mirror and fasten your seat belt.

- ⚠ WARNING** Risk of accident due to misjudgment of distances when using the outside mirror

The outside mirrors reflect objects on a smaller scale. The objects in view are in fact closer than they appear.

As a result, you may misjudge the distance between you and the road user driving behind you, e.g. when changing lanes.

- ▶ Therefore, always look over your shoulder in order to ensure that you are aware of the actual distance between you and the road users driving behind you.

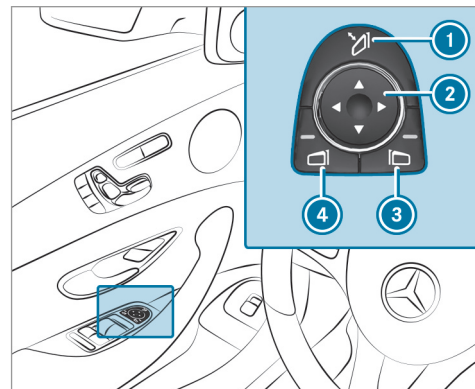

- ▶ **To fold in or out:** briefly press button ①.

- i If the battery has been disconnected or completely discharged, the outside mirrors must be reset. Only then will the automatic mirror folding function work properly.

- ▶ **To set:** select the required mirror using button ③ or ④.

- ▶ Use button ② to set the position of the mirror you have selected.

An outside mirror which has been pushed out of position can be engaged in position again in the following manner:

- ▶ **Vehicles without electrically folding outside mirrors:** Manually move the outside mirror into the correct position.

- ▶ **Vehicles with electrically folding outside mirrors:** Press and hold button ①.

You will hear a click and the mirror audibly engage in position. The mirror is set into the correct position.

Automatic anti-glare mirrors

⚠ WARNING Risk of burns and poisoning due to electrolyte of the anti-glare mirror

Electrolyte may escape if the glass in an automatic anti-glare mirror breaks.

The electrolyte is harmful and causes irritation. It must not come into contact with your

skin, eyes, respiratory organs or clothing or be swallowed.

If you come into contact with electrolyte, observe the following:

- Rinse the electrolyte from your skin and seek medical attention immediately.
- If electrolyte comes into contact with your eyes, rinse them thoroughly with clean water and seek medical attention immediately.
- If the electrolyte is swallowed, immediately rinse your mouth out thoroughly. Do not induce vomiting. Seek medical attention immediately.
- Immediately change out of clothing which has come into contact with electrolyte.
- If an allergic reaction occurs, seek medical attention immediately.

The outside and inside mirrors on the driver's side automatically go into anti-glare mode if light from a headlamp hits the inside mirror.

System limitations

The mirrors do not go into anti-glare mode in the following situations:

- the engine is switched off.
- reverse gear is engaged
- interior lighting is switched on

Parking position of the passenger outside mirror

The parking position makes parking easier. If the parking position has been stored and you engage reverse gear, the passenger outside mirror tilts downwards and you can see the front passenger side rear wheel.

The passenger outside mirror moves back to its original position in the following situations:

- if you shift the transmission to another position
- if you drive faster than 15 km/h
- if you press the button for the outside mirror on the driver's side

Saving the parking position of the passenger outside mirror

Prerequisite

Reverse gear must not be engaged when storing using the memory button.

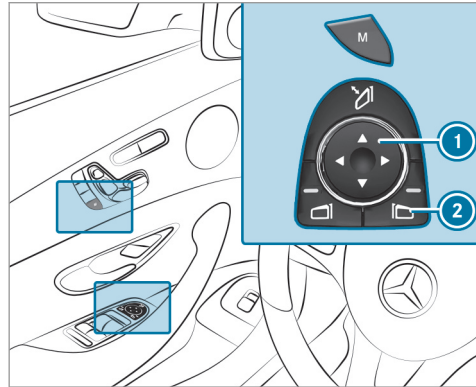

- ▶ **To store using the memory button:** select the passenger outside mirror using button ②.

- ▶ Move the passenger outside mirror into the desired parking position using button ①.
 - ▶ Press memory button M.
 - ▶ Confirm immediately using button ① to store the setting.
- ⓘ No more than three seconds may pass between pressing memory button M and button ①. The mirror setting process is canceled after three seconds.

Activating/deactivating the automatic mirror folding function

Multimedia system:

- ▶ Vehicle ▶ Vehicle Settings
- ▶▶ Autom. Mirror Folding
- ▶ Activate or deactivate the function.

Operating the sun visors

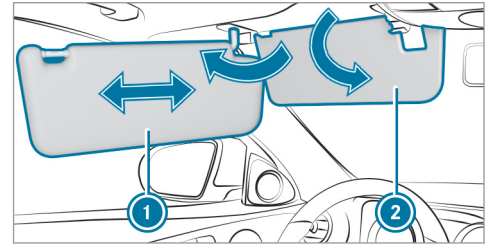

- ▶ **Glare from the front:** fold sun visor ① down.
- ▶ **Glare from the side:** swing sun visor ① to the side.
- ▶ Slide sun visor ① horizontally as required.
- ▶ **Vehicles with an additional sun visor:** fold additional sun visor ② down.

Overview of climate control systems

Dual-zone automatic climate control panel overview

The indicator lamps in the buttons indicate that the current function is activated.

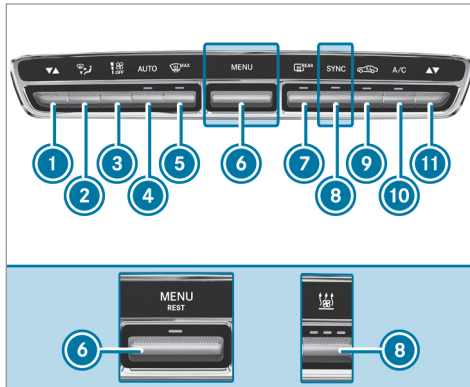

- ① To set the driver's side temperature
- ② To set the air distribution

- ③ To set the airflow or switch off climate control
- ④ To set climate control to automatic mode (→ page 121)
- ⑤ To defrost the windshield
- ⑥ To call up the climate control menu of the multimedia system
- ⑦ To switch the rear window heater on/off
- ⑧ **SYNC** To activate or deactivate synchronization (→ page 122)
- ⑨ To switch air-recirculation mode on/off (→ page 122)
- ⑩ To switch the A/C function on/off (→ page 121)
- ⑪ To set the front passenger side temperature

Operating the climate control system

Activating/deactivating climate control

- ▶ **To activate:** set the airflow to level 1 or higher using the button.
- ▶ **To deactivate:** set the airflow to level 0 using the button.

- ⓘ If climate control is deactivated, the windows can fog up more quickly. Deactivate climate control only briefly.

Activating/deactivating the A/C function via the control panel

The A/C function cools, heats and dehumidifies the interior air in the vehicle.

- ▶ Press the button.

Deactivate the A/C function only briefly otherwise the windows can fog up more quickly.

Condensation may drip from the underside of the vehicle when cooling mode is active. This is not a sign that there is a malfunction.









Setting climate control to automatic mode

In automatic mode, the set temperature is controlled and maintained at a constant level by the air supply.

- ▶ Press the button.
- ▶ **To switch to manual mode:** press the or button.

Air distribution settings

The symbols in the display indicate through which vents the airflow is being directed:

-  Defroster vents
-  Center and side air vents
-  Footwell vents
-  Center, side and footwell vents
-  Defroster vents and footwell vents
-  All vents
-  Defroster, center and side air vents
-  Automatic air distribution

Activating/deactivating the climate control synchronization function via the control panel

Climate control can be set centrally using the synchronization function. The temperature and air distribution setting for the driver's side is adopted automatically for the front passenger side.

- ▶ Press the **SYNC** button.

The synchronization function is deactivated if the settings for one of the other climate zones are changed.

Defrosting the windows

Windows fogged up on the inside

- ▶ Press the **AUTO** button.
- ▶ If the windows continue to fog up: press the  button.

Windows fogged up on the outside

- ▶ Switch on the windshield wipers.
- ▶ Press the **AUTO** button.

Switching air-recirculation mode on/off

- ▶ Press the  button.
The interior air will be recirculated.

Air-recirculation mode is switched off automatically.

- ⓘ If air-recirculation mode is switched on, the windows may fog up more quickly. Switch on air-recirculation mode only briefly.

Activating and deactivating ionization

Multimedia system:

- ↳ Vehicle ▶  Climate Control
- ▶ Ionization

Ionization cleans and refreshes the interior air of the vehicle. The ionization of the interior air is odorless.

- ▶ Switch the function on or off .

Perfume atomizer

Setting the perfume fragrance system

Prerequisites

- Automatic climate control is activated.
- The glove box is closed.

Multimedia system:

- ↳ Vehicle ▶  Climate Control ▶ Air Freshener

The fragrance system distributes a pleasant fragrance throughout the vehicle interior from a flask located in the glove box.

- ▶ **To set the intensity:** select **High**, **Medium**, **Low** or **Off**.

Inserting or removing a fragrance system flacon

- ⚠ **WARNING** Risk of injury from liquid perfume

If children open the flacon, they could drink the liquid perfume or it could come into contact with their eyes.

- ▶ Consult a doctor immediately if liquid perfume has been drunk.
- ▶ If liquid perfume comes into contact with your eyes or skin, rinse your eyes with clean water.
- ▶ If symptoms continue, consult a doctor.

- ⚠ **ENVIRONMENTAL NOTE** Environmental damage due to improper disposal of full flacons



Full flacons must not be disposed of with household waste.



Full flacons must be taken to a harmful substance collection point.

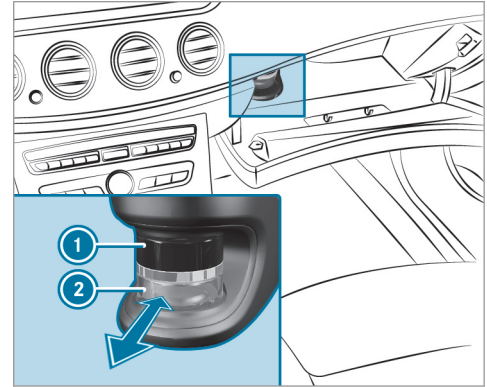

- ① Cover
- ② Flacon

- ▶ **To insert:** slide the flacon into the holder as far as it will go.

- ▶ **To remove:** pull out the flacon.

If you do not use genuine Mercedes-Benz interior perfumes, observe the manufacturers' safety notices on the perfume packaging.

Dispose of the genuine Mercedes-Benz interior perfume flacon when it is empty and do not refill it.

Refillable flacon

- ▶ Unscrew the cover of the empty flacon.
- ▶ Fill the flacon with a maximum of 0.5 fl. oz. (15 ml).
- ▶ Screw the cover back on to the flacon.

Always refill the empty refillable flacon with the same perfume. Observe the separate information sheet attached to the flacon.

Information on the windshield heater

The windshield heater is switched on automatically:

- if the  button is activated

After the vehicle is started the windshield heater is switched on automatically as needed.

Air vents

Adjusting the front air vents

⚠ WARNING - Danger of burns or frostbite due to being too close to the air vents

Very hot or very cold air can flow from the air vents.

This could result in burns or frostbite in the immediate vicinity of the air vents.

- ▶ Make sure that all vehicle occupants always maintain a sufficient distance to the air vents.
- ▶ If necessary, direct the airflow to another area of the vehicle interior.

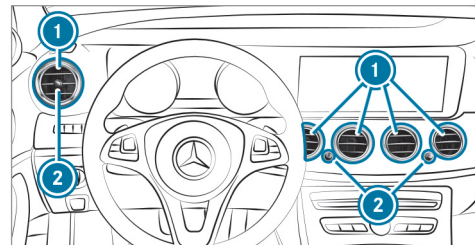

- ▶ **To open or close:** turn controller **2** to the left or right as far as it will go.
- ▶ **To adjust the airflow direction:** hold air vent **1** in the center and move it up or down or to the left or right.

Adjusting the rear air vents

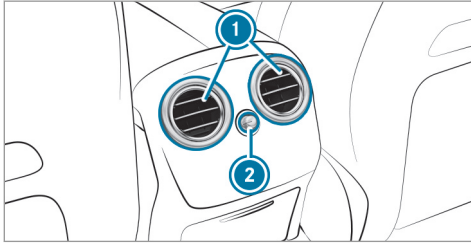

- ▶ **To open or close:** turn controller ② to the left or right as far as it will go.
- ▶ **To adjust the airflow direction:** hold rear air vent ① in the center and move it up or down or to the left or right.

Opening/closing the air vent in the glove box

! **NOTE** Damage to temperature-sensitive objects in the glove box

Temperature-sensitive objects stored in the glove box may be damaged by the air vent located inside it.

- ▶ Close the air vent when you heat the vehicle.
- ▶ At high outside temperatures, open the air vent and switch on the A/C function.

Requirement:

Automatic climate control is activated.

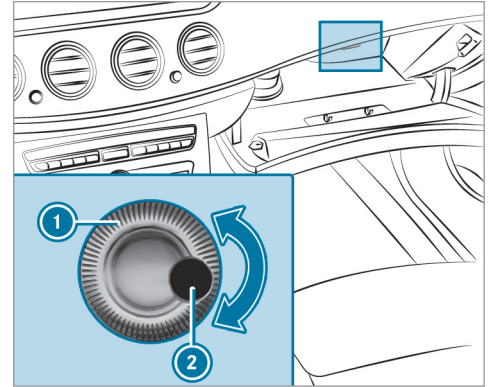

- ① Air vent controller
- ② Air vent

- ▶ **To open or close:** turn controller ① to the left or right.

Driving

Switching on the power supply or ignition using the start/stop button

⚠ WARNING Risk of accident and injury due to children left unattended in the vehicle

If children are left unattended in the vehicle, they could:

- Open doors, thereby endangering other persons or road users
- Get out of the vehicle and be hit by oncoming traffic
- Operate vehicle equipment

In addition, the children could also set the vehicle in motion, for example, by:

- Releasing the parking brake
- Shifting the transmission out of park position **P**
- Starting the engine.

- ▶ Never leave children and animals unattended in the vehicle.
- ▶ When leaving the vehicle, always take the SmartKey with you and lock the vehicle.
- ▶ Keep the SmartKey out of the reach of children.

⚠ WARNING Risk of exhaust gas poisoning

Combustion engines emit poisonous exhaust gases such as carbon monoxide. Inhaling these exhaust gases causes poisoning.

- ▶ Never leave the engine running in an enclosed space without sufficient ventilation.

⚠ WARNING Risk of fire caused by flammable material on the exhaust system

Flammable materials brought in by either animals or environmental influences may ignite if they come into contact with hot parts of the engine or exhaust system.

- ▶ Therefore, check regularly that there are no flammable materials in the engine compartment or on the exhaust system.

Prerequisites

- The SmartKey is in the vehicle.
- The key battery is not discharged.

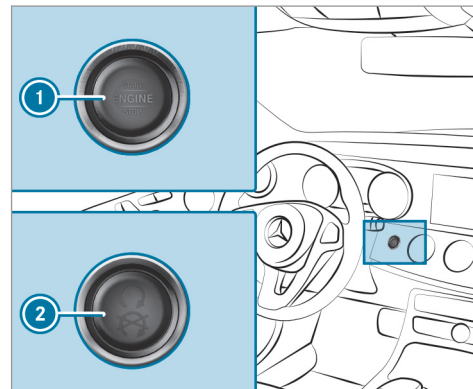

- ▶ **To switch on the power supply:** press button ① (USA) or ② (Canada) once. You can now activate the windshield wiper, for example.

The power supply is switched off again if the following conditions are met:

- The driver's door is open.
- You press button ① (USA) or ② (Canada) twice.

- ▶ **To switch on the ignition:** press button ① (USA) or ② (Canada) twice. The indicator lamps in the instrument cluster light up.

The ignition is switched off again if one of the following conditions is met:

- You do not start the vehicle within 15 minutes.
- You press button ① (USA) or ② (Canada) once.

Starting the vehicle

Starting the vehicle with the start/stop button

Prerequisites

- The SmartKey is in the vehicle.
- The SmartKey battery is not discharged.

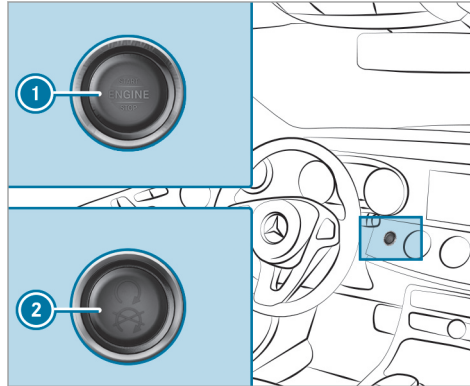

- ▶ Shift the transmission to position **P** or **N**.

- ▶ Depress the brake pedal and push button ① (USA) or ② (Canada) once.
- ▶ If the vehicle does not start: switch off non-essential consumers and press button ① (USA) or ② (Canada) once.
- ▶ If the vehicle still does not start: start the vehicle using the SmartKey.

Cooling or heating the vehicle interior before starting the journey

If you start the vehicle via your smartphone, the previously selected climate control setting is active.

Before starting, make sure:

- The legal stipulations in the area where your vehicle is parked permit engine starting via smartphone.
- It is safe to start and run the engine where your vehicle is parked.
- The fuel tank is sufficiently filled.
- The starter battery has been sufficiently charged.

Starting the vehicle using a smartphone

⚠ WARNING Risk of crushing or entrapment due to unintentional starting of the engine

Limbs could be crushed or trapped if the engine is started unintentionally during service or maintenance work.

- ▶ Always secure the engine against unintentional starting before carrying out maintenance or repair work.

Requirements

- Park position **P** is selected.
 - The anti-theft alarm system is not armed.
 - The panic alarm is not armed.
 - The hazard warning lights are switched off.
 - The engine hood is closed.
 - The doors are closed and locked.
 - The windows and sliding sunroof are closed.
- ▶ Start the vehicle using the smartphone:

- You can carry out a maximum of two consecutive starting attempts.
- You can stop the again vehicle any time.

Securing the engine against starting before carrying out maintenance or repair work:

- ▶ Switch on the hazard warning lights.
- or
- ▶ Unlock the doors.
- or
- ▶ Open the engine hood.

Starting a vehicle with a mobile phone (NFC)

Prerequisites

- The vehicle has multifunction telephony.
- Suitable mobile phone with NFC antenna (Near Field Communication).
- The "Digital Car Key in the smartphone" service is activated via the Mercedes connect me web app: <http://www.mercedes.me>.
- The mobile phone is sufficiently charged.

- ⓘ You can check the suitability of your mobile phone by entering the phone number at <http://www.mercedes.me>.
- ⓘ Further information on suitable mobile phones can be obtained from a Mercedes-Benz service center or at <http://www.mercedes-benz.com/connect>.

When you start the vehicle for the first time using your mobile phone, there must be a valid vehicle key in the vehicle.

- ⓘ The key is not needed for any further starts.

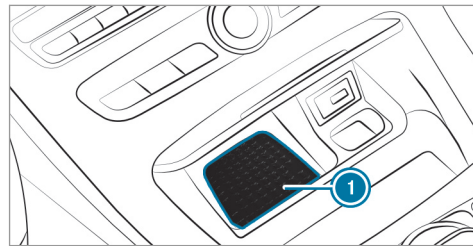

- ▶ Place the mobile phone onto rubber mat ⓘ.
- ▶ Start the vehicle using the start/stop button.

Starting the vehicle in emergency operation mode

If the vehicle cannot be started, the [Place the Key in the Marked Space](#) See Operator's Manual display message appears in the multifunction display.

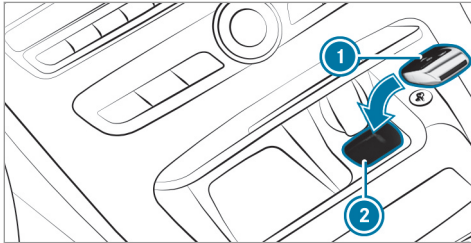

- ▶ Make sure that stowage space ② is empty.
- ▶ Remove SmartKey ① from the key ring.
- ▶ Place SmartKey ① in stowage space ②. The vehicle will start after a short while.

If you remove SmartKey ① from stowage space ② the engine continues running. For further vehicle starts however, SmartKey ①

must be located in stowage space ② during the entire journey.

- ▶ Have SmartKey ① checked at a qualified specialist workshop.

If the vehicle does not start:

- ▶ Leave SmartKey ① in stowage space ②.
 - ▶ Depress the brake pedal and start the vehicle using the start/stop button.
- ① You can also switch on the power supply or the ignition with the start/stop button.

Information on Hill Start Assist

Hill Start Assist holds the vehicle when pulling away on a hill under the following conditions:

- The transmission is in position **D** or **R**.
- The electric parking brake is released.

⚠ WARNING Risk of accident and injury caused by the vehicle rolling away

After a short time, Hill Start Assist no longer holds the vehicle and it can roll away.

- ▶ Therefore, swiftly move your foot from the brake pedal to the accelerator pedal. Never attempt to leave the vehicle if it is being held by Hill Start Assist.

Driving tips

Notes on breaking-in a new vehicle

To preserve the engine during the first 1,000 miles (1,500 km):

- drive at varying road speeds and engine speeds.
- drive the vehicle in drive program **C** or **E**.
- do not shift down a gear manually in order to brake.
- avoid overstraining the vehicle, e.g. driving at full throttle.
- do not depress the accelerator pedal past the pressure point (kickdown).
- gradually increase the engine speed only after 1,000 miles (1,500 km).

Please also observe the following breaking-in notes:

- In certain driving and driving safety systems, the sensors adjust automatically while a certain distance is being driven after the vehicle has been delivered or after repairs. Full system effectiveness is not achieved until the end of this teach-in process.
- Brake linings, brake disks and tires that are either new or have been replaced only achieve optimum braking effect and grip after several hundred kilometers of driving. Compensate for the reduced braking effect by applying greater force to the brake pedal.

Driving tips

⚠ WARNING Risk of accident due to objects in the driver's footwell

Objects in the driver's footwell may impede pedal travel or block a depressed pedal.

This jeopardizes the operating and road safety of the vehicle.

- ▶ Stow all objects in the vehicle securely so that they cannot get into the driver's footwell.
- ▶ Always install the floor mats securely and as prescribed in order to ensure that there is always sufficient room for the pedals.
- ▶ Do not use loose floor mats and do not place floor mats on top of one another.

⚠ WARNING Risk of accident due to unsuitable footwear

Operation of the pedals may be restricted due to unsuitable footwear such as:

- Shoes with platform soles
 - Shoes with high heels
 - Slippers
- ▶ When driving always wear suitable shoes in order to be able to operate the pedals safely.

⚠ WARNING Risk of accident due to the ignition being switched off whilst the vehicle is in motion

If you switch off the ignition whilst the vehicle is in motion safety-relevant functions will be restricted or no longer available. This may affect the power steering system and brake force boosting, for example.

You will need to use considerably more force to steer and brake.

- ▶ Do not switch off the ignition whilst the vehicle is in motion.

⚠ WARNING Risk of exhaust gas poisoning

Combustion engines emit poisonous exhaust gases such as carbon monoxide. Inhaling these exhaust gases causes poisoning.

- ▶ Never leave the engine running in an enclosed space without sufficient ventilation.

⚠ DANGER Risk of fatal injury due to poisonous exhaust gases

If the tailpipe is blocked or sufficient ventilation is not possible, poisonous exhaust gases such as carbon monoxide may enter the vehicle. This is the case if the vehicle gets stuck in snow, for example.

- ▶ Keep the tailpipe and the area around the vehicle free from snow when the engine or the stationary heater are running.
- ▶ Open a window on the windward side of the vehicle to ensure an adequate supply of fresh air.

⚠ WARNING Risk of accident or injury due to driving under the influence of alcohol and drugs

Driving and the consumption of alcohol and/or drugs are an extremely dangerous combination. Even small quantities of alcohol or drugs can compromise your reflexes, perception and judgment.

The possibility of a serious or even fatal accident is greatly increased when you drink or take drugs and drive.

- ▶ Do not drink or take drugs and drive or allow anyone to drive who has been drinking alcohol or taking drugs.

⚠ WARNING Risk of accident due to an overheated brake system

If you rest your foot on the brake pedal whilst driving, the brake system may overheat.

This increases the braking distance and the brake system may fail.

- ▶ Never use the brake pedal as a footrest.

⚠ NOTE Wearing out the brake linings by continuously depressing the brake pedal

- ▶ Do not depress the brake pedal continuously whilst driving.
- ▶ To use the braking effect of the engine, shift to a lower gear in good time.

⚠ NOTE Damage to the drivetrain and the engine when pulling away

- ▶ Do not warm up the engine when the vehicle is stationary. Pull away immediately.
- ▶ Avoid high engine speeds and driving at full throttle until the engine has reached operating temperature.
- ▶ Do not allow the wheels to spin.

⚠ NOTE Damage to the catalytic converter due to non-combusted fuel

The engine is not running smoothly and is misfiring.

Non-combusted fuel may get into the catalytic converter.

- ▶ Only depress the accelerator pedal slightly.
- ▶ Have the cause rectified immediately at a qualified specialist workshop.

Limited braking effect on salt-treated roads:

- the braking distance can increase considerably due to salt build-up on the brake disks and brake lining.
- maintain a much greater distance to the vehicle in front.

To prevent salt build-up:

- brake occasionally while paying attention to the traffic conditions.
- carefully depress the brake pedal at the end of the journey and when starting the next journey.

ECO start/stop function

Operation of the ECO start/stop function

The engine is switched off automatically:

- If you brake the vehicle to a standstill in transmission position **D** or **N**.
- If all vehicle conditions for an automatic engine stop are met.

The **A** symbol appears in the multifunction display when the vehicle is stationary.

If the engine is switched off by the ECO start/stop function and you open the driver's door, a warning tone sounds. The **Driver's Door Open & Transmission Not in P Risk of Vehicle Rolling Away** display message also appears in the multifunction display.

The engine is restarted automatically if:

- In transmission position **D** or **N** the brake pedal is released when the HOLD function is not active.
- You shift from transmission position **P**.
- You engage reverse gear **R**.
- You depress the accelerator pedal.
- You switch to drive program **S+**.
- An automatic engine start is necessary.

Deactivating or activating the ECO start/stop function

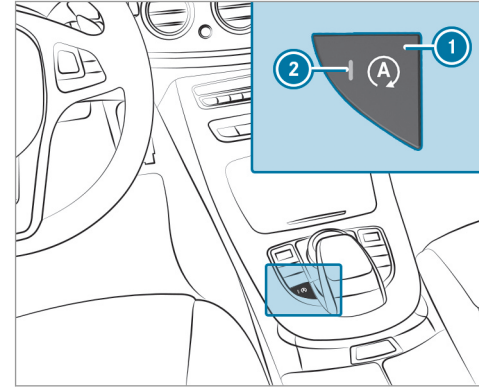

- ▶ Press button **1**.
If indicator lamp **2** lights up, the ECO start/stop function is switched on.

ECO display

The ECO display summarizes the driving style from the start of the journey to its completion and assists you in achieving the most economical driving style.

You can influence consumption if you:

- Drive with particular care.
- Drive the vehicle in drive program **E**.
- Observe the gearshift recommendations.

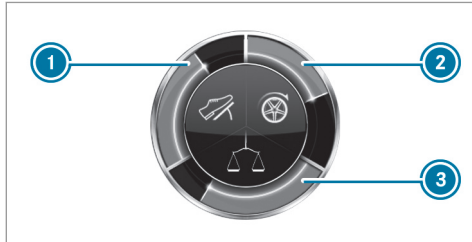

The outer area fills up and the inner area lights up green:

- ① moderate acceleration

- ② frequent and extended coasting
- ③ constant speed

The outer area empties and the inner area is gray:

- ① sporty acceleration
- ② heavy braking
- ③ Fluctuations in speed

You have driven economically when:

- The three outer areas are completely filled at the same time.
- The ECO display lights up.

The additional range achieved as a result of your economical driving style is shown under **Bonus fr. Start**. The range displayed does not indicate a fixed consumption reduction.

DYNAMIC SELECT switch

Function of the DYNAMIC SELECT switch

Use the DYNAMIC SELECT switch to change the following drive programs:

- **I (Individual)**: individual settings
- **S+ (Sport Plus)**: particularly sporty driving style
- **S (Sport)**: sporty driving style
- **C (Comfort)**: comfortable and economical driving style
- **E (Economy)**: particularly economical driving style

Depending on the drive program selected, the following vehicle characteristics will change:

- Drive system
 - Engine and transmission management
 - ESP®
 - Distance Pilot DISTRONIC
- Suspension
- Steering

- The availability of the ECO start/stop function

Operating the DYNAMIC SELECT switch

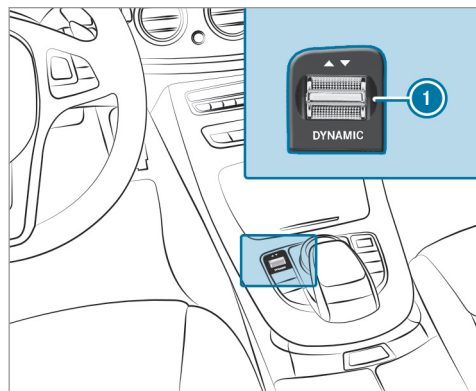

- ▶ Press DYNAMIC SELECT switch ① forwards or backwards. The drive program selected appears in the multifunction display.

Configuring drive program I

Multimedia system:

- ▶ Vehicle ▶ DYNAMIC SELECT
- ▶ Individual

- ▶ Select Drive, Suspension, Steering or ECO Start/Stop Func..
- ▶ Select the individual setting.

Displaying vehicle data

Multimedia system:

- ▶ Vehicle ▶ DYNAMIC SELECT
- ▶ Select Vehicle Data.

Displaying engine data

Multimedia system:

- ▶ Vehicle ▶ DYNAMIC SELECT
- ▶ Select Engine Data.
- ① The values for engine output and engine torque may deviate from the nominal values.

Items that can influence this are, for example:

- engine speed
- sea level
- fuel grade
- outside temperature

Automatic transmission

DIRECT SELECT selector lever

Function of the DIRECT SELECT selector lever

⚠ WARNING Risk of accident and injury due to children left unattended in the vehicle

If children are left unattended in the vehicle, they could:

- Open doors, thereby endangering other persons or road users
- Get out of the vehicle and be hit by oncoming traffic
- Operate vehicle equipment

In addition, the children could also set the vehicle in motion, for example, by:

- Releasing the parking brake
- Shifting the transmission out of park position **P**
- Starting the engine.

- ▶ Never leave children and animals unattended in the vehicle.
- ▶ When leaving the vehicle, always take the SmartKey with you and lock the vehicle.
- ▶ Keep the SmartKey out of the reach of children.

⚠ WARNING Risk of accident due to incorrect gearshifting

If the engine speed is higher than the idle speed and you engage the transmission position **D** or **R**, the vehicle may accelerate sharply.

- ▶ If you engage the transmission position **D** or **R** always depress the brake

pedal firmly and do not accelerate at the same time.

! **NOTE** Damage to the automatic transmission caused by changing the transmission position during the journey

- ▶ Only change the transmission position when the vehicle is stationary.

Use the DIRECT SELECT selector lever to shift the transmission position. The current transmission position is displayed in the multifunction display.

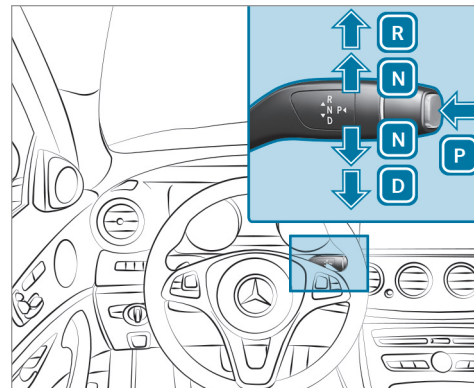

- P** Park position
- R** Reverse gear
- N** Neutral
- D** Drive position

Engaging reverse gear R

- ▶ Depress the brake pedal and push the DIRECT SELECT selector lever up past the first point of resistance.
Transmission position display **R** is shown in the multifunction display.

Shifting to neutral N

- ▶ Depress the brake pedal and push the DIRECT SELECT selector lever up or down to the first point of resistance.
Transmission position display **N** is shown in the multifunction display.

Releasing the brake pedal will allow you to move the vehicle freely, e.g. to push it or tow it away.

If you switch the engine off with the transmission in position **D** or **R**, the automatic transmission shifts to **P** automatically.

If you want the automatic transmission to remain in neutral N:

- ▶ Switch on the ignition.
- ▶ Depress the brake pedal and shift to neutral **N**.

- ▶ Release the brake pedal.
- ▶ Release the electric parking brake.
- ▶ Switch the ignition off.

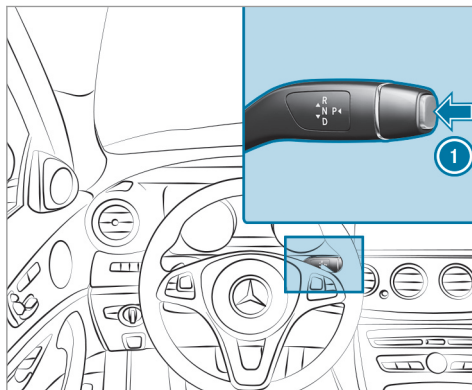
Engaging park position P

- ▶ Press button **1**.
Transmission position display **P** is shown in the multifunction display.

Park position **P** is engaged automatically if one of the following conditions is met:

- If you switch off the engine.
- You open the driver's door when the vehicle is stationary or when driving at a very low speed and the transmission is in position **D** or **R**.

Engaging drive position D

- ▶ Depress the brake pedal and push the DIRECT SELECT selector lever down past the first point of resistance.
Transmission position display **D** is shown in the multifunction display.

Function of the automatic transmission

When the automatic transmission is in transmission position **D**, it shifts the gears automatically. This is determined by:

- The selected drive program
- The position of the accelerator pedal
- The road speed

Have the transmission checked at a qualified specialist workshop immediately, in the following cases:

- The transmission is losing oil.
- The transmission has problems shifting gear.
- The acceleration ability is deteriorating.

Manual gearshifting

⚠ WARNING Risk of skidding and of an accident due to shifting down on slippery road surfaces

If you shift down on slippery road surfaces to increase the engine braking effect, the drive wheels may lose traction.

- ▶ Do not shift down on slippery road surfaces to increase the engine braking effect.

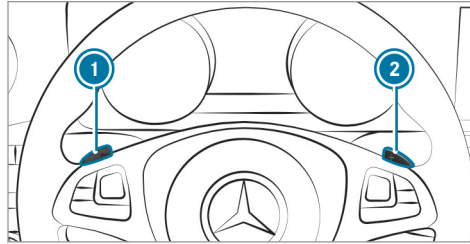

- ▶ **To activate:** pull steering wheel gearshift paddle ① or ②. Manual gearshifting is activated for a short time. The current gear is displayed in the multifunction display.
- ▶ **To shift up:** pull steering wheel gearshift paddle ②.
- ▶ **To shift down:** pull steering wheel gearshift paddle ①.
- ▶ **To deactivate:** pull steering wheel gearshift paddle ② and hold it in place. The transmission position **D** appears in the multifunction display.

- ① If you select the **manual** drive setting in drive program **I**, manual gearshifting is permanently activated.

Gearshift recommendation

The gearshift recommendations assist you in adopting an economical driving style.

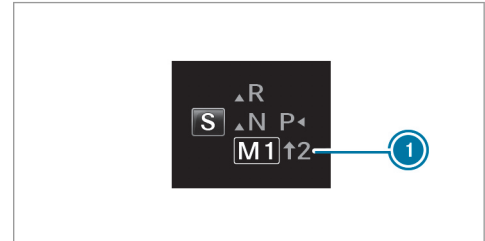

- ▶ If gearshift recommendation message ① is shown in the multifunction display, shift to the recommended gear.

Using kickdown

- ▶ **Maximum acceleration:** depress the accelerator pedal beyond the pressure point.

During kickdown, you cannot shift gears using the steering wheel gearshift paddles. The automatic transmission shifts up to the next gear when the maximum engine speed is reached to protect the engine from overrevving.

- ▶ Ease off the accelerator pedal once the desired speed is reached.

Refueling

Refueling the vehicle

- ⚠ **WARNING** Risk of fire and explosion caused by fuel

Fuels are highly inflammable.

- ▶ You must avoid fire, open flames, creating sparks and smoking.

- ▶ Before refueling, switch off the engine and, if installed in your vehicle, the stationary heater.

⚠ **WARNING** Risk of injury from fuel

Fuels are poisonous and harmful to your health

- ▶ Do not swallow fuel or let it come into contact with skin, eyes or clothing.
- ▶ Do not inhale fuel vapors.
- ▶ Keep children away from fuel.

If you or other people come into contact with fuel, observe the following:

- ▶ Immediately rinse fuel off your skin with soap and water.
- ▶ If fuel comes into contact with your eyes, immediately rinse them thoroughly with clean water. Seek medical attention immediately.

- ▶ If you swallow fuel, seek medical attention immediately. Do not induce vomiting.
- ▶ Change immediately out of clothing that has come into contact with fuel.

⚠ **WARNING** Risk of explosion or fire due to electrostatic charge

Electrostatic charge can cause sparks and thereby ignite fuel vapors.

- ▶ Always touch the metal vehicle body before opening the fuel filler cap or touching the pump nozzle.

This discharges any electrostatic charge that may have built up.

! **NOTE** Damage caused by the wrong fuel

Fuel that does not conform to the required quality can lead to increased wear as well as damage to the engine and exhaust system.

- ▶ Only use the fuel recommended.

! NOTE Damage caused by the wrong fuel

Even small amounts of the wrong fuel could result in damage to the fuel system, the engine and the emission control system.

- ▶ Only refuel with low-sulfur premium grade fuel.

This fuel may contain up to 10 % ethanol. Your vehicle is suitable for use with E10 fuel.

Do not refuel using:

- Diesel
- E15, E85, E100
- Gasoline containing methanol (M15, M30, M85, M100)
- Gasoline with additives containing metal

If you accidentally refuel with the wrong fuel:

- ▶ Do not switch the ignition on.
- ▶ Consult a qualified specialist workshop.

! NOTE Do not use diesel to refuel vehicles with a gasoline engine.

- ▶ Do not switch on the ignition if you accidentally refuel with the wrong fuel. Otherwise, fuel can enter the fuel system. Even small amounts of the wrong fuel could result in damage to the fuel system and the engine. Notify a qualified specialist workshop and have the fuel tank and fuel lines drained completely.

! NOTE Do not overfill the fuel tank as this may damage the fuel system.

- ▶ Only fill the fuel tank until the pump nozzle switches off.

! NOTE Do not overfill the fuel tank as otherwise fuel could spray out when the pump nozzle is removed.

- ▶ Only fill the fuel tank until the pump nozzle switches off.

Requirement:

The vehicle must be unlocked.

- ① Do not get into the vehicle again during the refueling process. Otherwise, electrostatic charge could build up again.

Parking**Switching off the vehicle with the start/stop button****⚠ WARNING** Risk of fire caused by hot exhaust system parts

Flammable material such as leaves, grass or twigs may ignite if they come into contact with hot parts of the exhaust system or exhaust gas flow.

- ▶ Park the vehicle so that no flammable material can come into contact with hot vehicle components.
- ▶ In particular, do not park on dry grassland or harvested grain fields.

⚠ WARNING Risk of accident and injury due to children left unattended in the vehicle

If you leave children unaccompanied in the vehicle, they may be able to set the vehicle in motion, for example by:

- Releasing the parking brake.
- Shifting the transmission out of park position **P**.
- Starting the engine.

In addition, they may operate vehicle equipment.

- ▶ Never leave children and animals unattended in the vehicle.
- ▶ When leaving the vehicle, always take the SmartKey with you and lock the vehicle.

! NOTE Damage to the vehicle or the drivetrain caused by the vehicle rolling away

- ▶ Always properly secure the vehicle against rolling away.

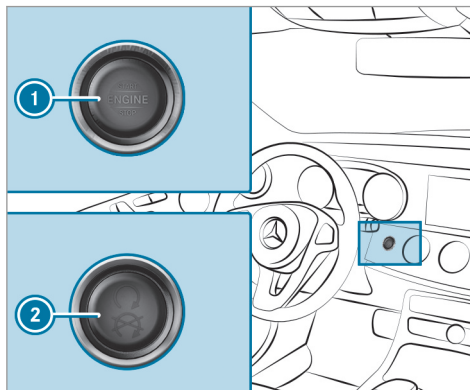

- ▶ On uphill or downhill inclines, turn the front wheels towards the curb.
- ▶ Press button ① (USA) or ② (Canada) once.

- ① When you switch off the vehicle, you can still operate the side window and the panoramic sliding sunroof for five minutes.

Garage door opener

Programming the buttons for the garage door opener

⚠ WARNING Risk of exhaust gas poisoning

Combustion engines emit poisonous exhaust gases such as carbon monoxide. Inhaling these exhaust gases causes poisoning.

- ▶ Never leave the engine running in an enclosed space without sufficient ventilation.

⚠ WARNING Risk of injury and entrapment when opening the garage door using the garage door opener

When you operate or program the garage door with the integrated garage door opener, persons in the range of movement of the

garage door can become trapped or struck by the garage door.

- ▶ When using the integrated garage door opener, always make sure that nobody is within the sweep of the garage door.

Only operate the garage door opener on the following garage doors:

- Garage doors with a safety stop and reversing feature.
- Garage doors which conform to the current U.S. safety standards.

When programming a garage door opener, park the vehicle outside the garage.

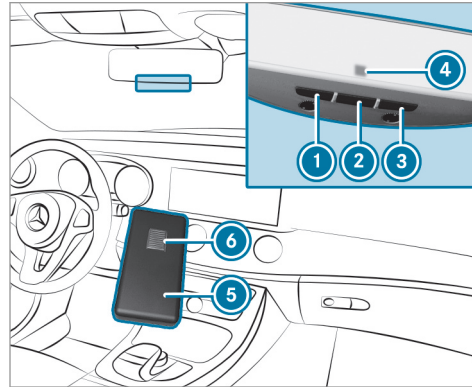

- ▶ Check if the transmitter frequency of the remote control has the frequency range of 280 to 868 MHz.

- ▶ Press and hold buttons ①, ② or ③. Indicator lamp ④ flashes yellow.

- ⓘ It can take up to 20 seconds before the indicator lamp flashes yellow.

- ▶ Release the previously pressed button. Indicator lamp ④ continues to flash yellow.
- ▶ Point remote control ⑤ at a distance of 1 in (1 cm) to 3 in (8 cm) towards buttons ①, ② or ③.
- ▶ Press and hold button ⑥ of remote control ⑤.
 - Indicator lamp ④ lights up green: programming is completed.
 - Indicator lamp ④ flashes green: programming has been successful. Additionally, synchronization of the rolling code must also take place.
 - Indicator lamp ④ goes out, without lighting up green or flashing: repeat the procedure.
- ▶ Release button ⑥ on remote control ⑤.

- ⓘ The remote control for the garage door drive is not included in the scope of delivery of the garage door opener.

Synchronizing the rolling code

Prerequisites

- The garage door system uses a rolling code.
- The vehicle must be within range of the garage door or exterior gate drive.
- The vehicle as well as persons and objects, are located outside the sweep of the garage door.

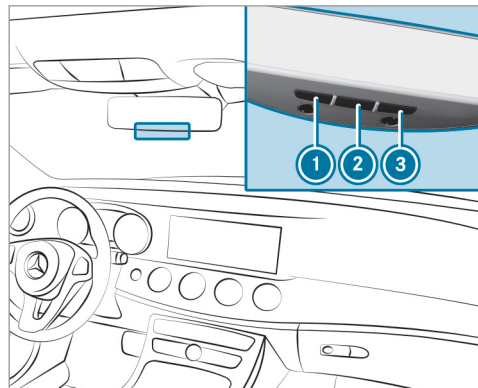

- ▶ Press the programming button on the door drive unit. Initiate the next step within approximately 30 seconds.
- ▶ Press programmed button ①, ② or ③ repeatedly, until the door closes.
- ⓘ Please also read the operating instructions for the garage door drive.

Resolving problems when programming the remote control

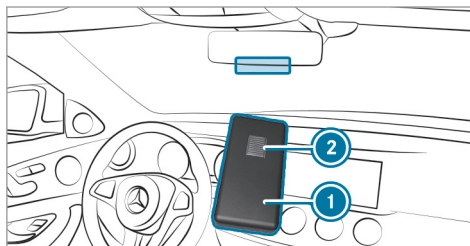

- ▶ Check if the transmitter frequency of remote control ① is supported.
- ▶ Replace the batteries in remote control ①.

- ▶ Hold remote control ① at various angles at a distance between 1 in (1 cm) to 3 in (8 cm) in front of the inside mirror. You should test every position for at least 25 seconds before trying another position.
- ▶ Hold remote control ① at the same angles at various distances in front of inside mirror. You should test every position for at least 25 seconds before trying another position.
- ▶ Note that some remote controls transmit only for a limited period, press button ② on remote control ① again before transmission ends.
- ▶ Align the antenna line of the garage door opener unit with the remote control.
- ⓘ Support and additional information on programming:
 - On the toll free HomeLink® Hotline on 1-800-355-3515.
 - On the Internet at <http://www.homelink.com>

Opening/closing the garage door

Prerequisite

The corresponding button is programmed to operate the garage door.

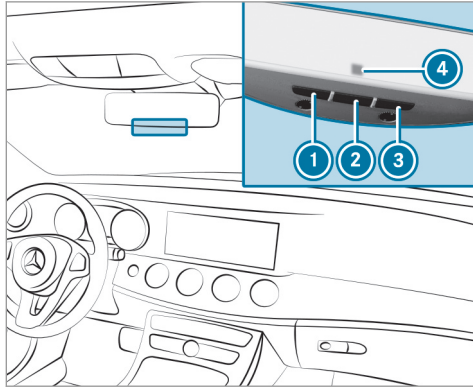

- ▶ Press and hold buttons ①, ② or ③ until the garage door opens or closes.
- ▶ When indicator lamp ④ flashes yellow: press the previously pressed button again until the garage door opens or closes.

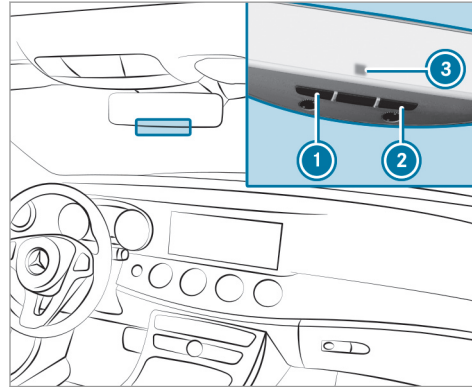
Clearing the garage door opener memory

- ▶ Press and hold buttons ① and ②. Indicator lamp ③ lights up yellow.
- ▶ If indicator lamp ③ flashes green: release buttons ① and ②.

Electric parking brake**Automatically applying the electric parking brake**

⚠ WARNING Risk of accident and injury due to children left unattended in the vehicle

If you leave children unaccompanied in the vehicle, they may be able to set the vehicle in motion, for example by:

- Releasing the parking brake.
- Shifting the transmission out of park position **P**.
- Starting the engine.

In addition, they may operate vehicle equipment.

- ▶ Never leave children and animals unattended in the vehicle.
- ▶ When leaving the vehicle, always take the SmartKey with you and lock the vehicle.

The electric parking brake is applied if the transmission is in position **P** and one of the following conditions is fulfilled:

- The engine is switched off.
- The seat belt tongue is not inserted in the seat belt buckle and the driver's door is opened.

i To prevent application: pull the handle of the electric parking brake.

The electric parking brake is also applied if one of the following conditions is fulfilled:

- The Distance Pilot DISTRONIC brings the vehicle to a standstill.
- The HOLD function is keeping the vehicle stationary.
- Active Parking Assist is keeping the vehicle stationary.

In addition, one of the following conditions must be fulfilled:

- The engine is switched off.

- The seat belt tongue is not inserted in the seat belt buckle and the driver's door is opened.
- There is a system malfunction.
- The power supply is insufficient.
- The vehicle is stationary for a lengthy period.

When the electric parking brake is applied, the **PARK** (USA) or **(P)** (Canada) indicator lamp lights up in the instrument cluster.

The electric parking brake is not automatically applied if the engine is switched off by the ECO start/stop function.

Releasing the electric parking brake automatically

The electric parking brake is released when all of the following conditions are fulfilled:

- The engine is running.
- The seat belt tongue is inserted into the seat belt buckle.
- The transmission is in position **D** or **R** and you depress the accelerator pedal or you

shift from transmission position **P** to **D** or **R**.

- If the transmission is in position **R**, the trunk lid must be closed.

If the seat belt tongue is not inserted into the seat belt buckle, the following conditions must be fulfilled:

- The driver's door is closed.
- You move the transmission out of transmission position **P** or you have previously driven faster than 2 mph (3 km/h).
- If the transmission is in position **R**, the trunk lid must be closed.

If the electric parking brake is released, the **PARK** (USA) or **(P)** (CANADA) indicator lamp in the instrument cluster goes out.

Applying or releasing the electric parking brake manually

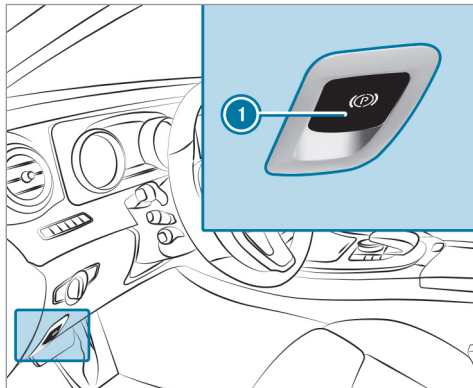

- ▶ **To apply:** push handle ①.
The **PARK** (USA) or **(P)** (Canada) indicator lamp appears in the instrument cluster.
- ▶ **To release:** switch on the ignition.

- ▶ Pull handle ①.
The **PARK** (USA) or **(P)** (Canada) indicator lamp in the instrument cluster goes out.

Emergency braking

- ▶ Press and hold handle ①.
When the vehicle has been braked to a standstill:
 - The electric parking brake is applied.
 - The **PARK** (USA) or **(P)** (Canada) symbol appears in the instrument cluster.

Parking the vehicle

- If you leave the vehicle parked for longer than four weeks, damage may occur to the battery.
- If you leave the vehicle parked for longer than six weeks, it may suffer damage as a result of lack of use.
- Information on parking your vehicle can be obtained at a qualified specialist workshop.

Standby mode

Function of the standby mode

Standby mode is characterized by the following:

- The vehicle can be parked over a long period of time without losing power.
- The vehicle battery is preserved.
- The maximum period out of use is shown in the multimedia system display.
- Functions such as interior protection or tow-away protection are not available.
- The connection to online services is interrupted.

If the following conditions are fulfilled, standby mode can be activated or deactivated using the multimedia system:

- The engine is switched off.
- The ignition is switched on.

Exceeding the vehicle's displayed period out of use may cause inconvenience, i.e. it cannot be guaranteed that the starter battery will reliably start the engine.

The starter battery must be charged in the following situations:

- the vehicle's period out of use must be extended.
 - the **Battery Charge Insufficient for Standby Mode** message appears in the multimedia system display.
-  Standby mode is automatically deactivated when the ignition is switched on.

Activating or deactivating standby mode

Multimedia system:

→ **Vehicle** →  **Vehicle Settings**

→ **Standby Mode**

- ▶ Activate or deactivate the function. When you activate the function, a prompt appears.
- ▶ Select **Yes**. Standby mode is activated.

Driving and driving safety systems

Driving systems and your responsibility

Your vehicle is equipped with driving systems which assist you in driving, parking and maneuvering the vehicle. The driving systems are aids and do not relieve you of your responsibility. Pay attention to the traffic conditions at all times and intervene when necessary. Be aware of the limitations regarding the safe use of these systems.

Function of the radar sensors

Some driving and driving safety systems use radar sensors to monitor the area in front of, behind or next to the vehicle (depending on the vehicle's equipment).

Depending on the vehicle's equipment, the radar sensors are integrated behind the bumpers and/or behind the radiator grill. Keep these parts free of dirt, ice and slush (→ page 271). The sensors must not be covered, for example by bicycle racks, overhanging loads or radar-reflecting stickers. Following an impact and in

the event of associated damage, which may not be visible, to the bumpers or radiator grille, have the function of the radar sensors checked at a qualified specialist workshop. The driver assistance system may no longer work properly.

Overview of driving and driving safety systems

In this section, you will find information about the following driving safety systems:

- 360° Camera (→ page 175)
- ABS (**A**nti-**l**ock **B**raking **S**ystem) (→ page 147)
- Distance Pilot DISTRONIC (→ page 158)
- Adaptive Brake Lights
- Adaptive Damping System (→ page 167)
- AIR BODY CONTROL (→ page 167)
- Active Brake Assist
- Active Brake Assist with cross-traffic function
- Active Lane Keeping Assist (→ page 186)
- ATTENTION ASSIST (→ page 182)
- BAS (**B**rake **A**ssist **S**ystem) (→ page 147)

- EBD (Electronic Brake force Distribution) (→ page 151)
- ESP® (Electronic Stability Program) (→ page 148)
- DRIVE PILOT (→ page 163)
- HOLD function (→ page 166)
- Steering Pilot (→ page 163)
- Parking Pilot (→ page 178)
- PARKTRONIC (→ page 170)
- Reversing camera (→ page 172)
- Cruise control (→ page 156)
- Blind Spot Assist and Active Blind Spot Assist (→ page 184)

Functions of ABS (anti-lock braking system)

ABS regulates the brake pressure in critical driving situations:

- During braking, the wheels are prevented from locking, e.g. due to maximum full-stop braking or insufficient traction of the tires.
- Vehicle steerability while braking is ensured.

- ABS is active from speeds of approx. 5 mph (8 km/h).

If ABS intervenes when braking, you will feel a pulsing in the brake pedal. The pulsating brake pedal can be an indication of hazardous road conditions and can serve as a reminder to take extra care while driving.

System limitations

ABS may be impaired or may not function if a malfunction has occurred and the yellow  ABS warning lamp lights up continuously in the instrument cluster after the engine is started.

Function of BAS (Brake Assist System)

⚠ WARNING Risk of an accident caused by a malfunction in BAS (Brake Assist System)

If BAS is malfunctioning, the braking distance may increase in an emergency braking situation.

▶ Depress the brake pedal with full force in emergency braking situations. ABS prevents the wheels from locking.

BAS supports your emergency braking situation with additional brake force.

If you depress the brake pedal quickly, BAS is activated:

- BAS automatically boosts the brake pressure.
- BAS can shorten the braking distance.
- ABS prevents the wheels from locking.

The brakes will function as usual once you release the brake pedal. BAS is deactivated.

Functions of ESP® (Electronic Stability Program)

⚠ WARNING Risk of skidding if ESP is malfunctioning®

If ESP® is malfunctioning, ESP® cannot carry out vehicle stabilization. In addition, other driving safety systems are switched off.

- ▶ Drive on carefully.
- ▶ Have ESP® checked at a qualified specialist workshop.

⚠ WARNING Risk of skidding if ESP® is deactivated

If you deactivate ESP®, ESP® cannot carry out vehicle stabilization.

- ▶ ESP® should only be deactivated in the following situations.

ESP® monitors and improves driving stability and traction, particularly in the following situations:

- When pulling away on wet or slippery roads.

- When braking.
- In strong winds when you are driving faster than 50 mph (80 km/h).

ESP® can stabilize the vehicle by intervening in the following ways:

- One or more wheels are braked.
- The engine output is adapted according to the situation.

ESP® is deactivated if the ESP® OFF  warning lamp lights up continuously in the instrument cluster:

- Driving stability will no longer be improved.
- Crosswind Assist is no longer active.
- The drive wheels could spin.
- ETS/4ETS traction control is still active.

i Even when ESP® is deactivated, you are still assisted by ESP® when braking.

ESP® is intervening if the ESP®  warning lamp flashes in the instrument cluster:

- Do not deactivate ESP®.

- Only depress the accelerator pedal as far as is necessary.
- Adapt your driving style to suit the current road and weather conditions.

Deactivate ESP® in the following situations to improve traction:

- when using snow chains
- in deep snow
- on sand or gravel

i Spinning the wheels results in a cutting action which provides better grip.

ESP® is deactivated if the  ESP® OFF warning lamp lights up continuously in the instrument cluster.

If the ESP®  warning lamp lights up continuously, ESP® is not available due to a malfunction.

Observe any information which may be displayed in the instrument cluster:

- Warning and indicator lamps (→ page 379)
- Display messages

ETS/4ETS (Electronic Traction System)

ETS/4ETS traction control is part of ESP®.

ETS/4ETS can improve the vehicle's traction by intervening in the following ways:

- The drive wheels are braked individually if they spin.

- More drive torque is transferred to the wheel or wheels with traction.

Influence of drive programs on ESP®

The drive programs enable ESP® to adapt to different weather and road conditions as well as

the driver's preferred driving style. You can select the drive programs using the DYNAMIC SELECT switch.

Drive program	ESP® mode	Characteristics
C (Comfort) E (Economy)	ESP® Comfort	These drive programs provide the ideal balance between traction and stability. Select drive program E or C in difficult road conditions, such as in snow or ice, or when the road is wet from rain.
S (Sport)	ESP® Sport	This drive program provides the ideal balance between traction and stability.
S+ (Sport Plus)	ESP® Sport Plus	The vehicle's own understeering and oversteering characteristics are accentuated. This allows a more active driving style to be adopted. This drive program requires more active involvement on the part of the driver. Only select this drive program in good road conditions, for example on dry, clear stretches of road.

Activating/deactivating ESP® (Electronic Stability Program)

Multimedia system:

➔ Vehicle ➔  Assistance ➔ ESP

▶ Activate or deactivate the function.

ESP® is deactivated if the ESP® OFF  warning lamp lights up continuously in the instrument cluster.

Observe the information on warning lamps and display messages which may be shown in the instrument cluster.

Functions of ESP® Crosswind Assist

ESP® Crosswind Assist detects sudden gusts of side wind and helps the driver to keep the vehicle in the lane:

- ESP® Crosswind Assist is active at vehicle speeds between 50 mph (80 km/h) and 125 mph (200 km/h) when driving straight ahead or cornering slightly.
- The vehicle is stabilized by means of individual brake application on one side.

Function of EBD (Electronic Brake force Distribution)

EBD is characterized by the following:

- Monitoring and closed-loop control of the brake pressure on the rear wheels.
- Improved driving stability when braking, especially on bends.

Function of Active Brake Assist

Active Brake Assist consists of:

- Distance warning function
- Autonomous braking function
- Appropriate brake support
- **Vehicles with the Driving Assistance Package:** Evasive Steering Assist

Active Brake Assist can help you to minimize the risk of a collision with vehicles or pedestrians or to reduce the effects of such a collision.

If Active Brake Assist has detected a risk of collision, you will be warned visually and acoustically.

If you do not react to the visual or acoustic warning, autonomous braking can be initiated in critical situations.

In especially critical situations, Active Brake Assist can initiate autonomous braking directly. In this case, the visual and acoustic warning signal is issued simultaneously with braking.

If you brake yourself in a critical situation or operate the brake during an autonomous braking process, you are given appropriate brake support. This can increase the brake pressure up to maximum full-stop braking, if necessary.

By triggering the autonomous braking function or appropriate brake support, additional preventive measures to protect occupants (PRE-SAFE) can be initiated if the vehicle is equipped with them.

⚠ WARNING Risk of an accident caused by limited detection performance of Active Brake Assist

Active Brake Assist cannot always clearly identify objects and complex traffic situations.

In such cases, Active Brake Assist might:

- give an unnecessary warning or brake the vehicle
 - not give a warning or not brake the vehicle.
- ▶ Always pay careful attention to the traffic situation; do not rely on Active Brake Assist alone.
- ▶ Be ready to brake and take evasive action if necessary.

Also observe the system limitations of Active Brake Assist.

The individual subfunctions are available in the following speed ranges:
Distance warning function

The distance warning function issues a warning at speeds:

- From approximately 18 mph (30 km/h), if over several seconds the distance maintained to the vehicle traveling in front is

insufficient for the driven speed. The distance warning lamp then lights up in the instrument cluster .

- from approximately 4 mph (7 km/h), if you approach a vehicle or a pedestrian to within a critical distance. An intermittent warning tone sounds and the distance warning lamp lights up in the instrument cluster .

Brake immediately or take evasive action, provided it is safe to do so.

The distance warning function can support you in the following situations with an intermittent warning tone and warning lamp:

	Vehicles traveling in front	Stationary vehicles	Crossing vehicles	Crossing pedestrians	Stationary pedestrians
Vehicles without Driving Assistance Package	up to approx. 155 mph (250 km/h)	up to approx. 50 mph (80 km/h)	no reaction	up to approx. 37 mph (60 km/h)	no reaction
Vehicles with Driving Assistance Package	up to approx. 155 mph (250 km/h)	up to approx. 62 mph (100 km/h)	up to approx. 43 mph (70 km/h)	up to approx. 43 mph (70 km/h)	up to approx. 43 mph (70 km/h)

Autonomous braking function

The autonomous braking system may intervene at speeds starting from approximately 4 mph (7 km/h) in the following situations:

	Vehicles traveling in front	Stationary vehicles	Crossing vehicles	Crossing pedestrians	Stationary pedestrians
Vehicles without Driving Assistance Package	up to approx. 124 mph (200 km/h)	up to approx. 31 mph (50 km/h)	no reaction	up to approx. 37 mph (60 km/h)	no reaction
Vehicles with Driving Assistance Package	up to approx. 155 mph (250 km/h)	up to approx. 62 mph (100 km/h)	up to approx. 43 mph (70 km/h)	up to approx. 43 mph (70 km/h)	up to approx. 43 mph (70 km/h)

Appropriate brake support

Selective braking assistance may intervene at speeds starting from approximately 4 mph (7 km/h) in the following situations:

	Vehicles traveling in front	Stationary vehicles	Crossing vehicles	Crossing pedestrians	Stationary pedestrians
Vehicles without Driving Assistance Package	up to approx. 155 mph (250 km/h)	up to approx. 50 mph (80 km/h)	no reaction	up to approx. 37 mph (60 km/h)	no reaction
Vehicles with Driving Assistance Package	up to approx. 155 mph (250 km/h)	up to approx. 62 mph (100 km/h)	up to approx. 43 mph (70 km/h)	up to approx. 43 mph (70 km/h)	up to approx. 43 mph (70 km/h)

Canceling a brake application of Active Brake Assist

You can cancel a brake application of Active Brake Assist at any time by:

- Depressing the accelerator pedal completely.
- Taking your foot off the brake pedal.

Active Brake Assist cancels the intervention when at least one of the following conditions is fulfilled:

- You take evasive action by steering to avoid an obstacle.
- There is no longer a risk of collision.
- There is no longer an obstacle detected in front of your vehicle.

Evasive Steering Assist

Evasive Steering Assist has the following characteristics:

- It can detect stationary or intersecting pedestrians.
- If it detects evasive action, it can help the driver by providing additional steering assistance.

- It can be activated by rapid swerving during an evasive action.
- It can give support when swerving, and when straightening the vehicle.
- It can take action from a speed of approximately 12 mph (20 km/h) up to a speed of approximately 43 mph (70 km/h).
- You can end the support at any time by actively steering.

⚠ WARNING Risk of an accident despite Evasive Steering Assist

Evasive Steering Assist cannot always clearly identify objects and complex traffic situations.

In addition, the steering support of Evasive Steering Assist is generally not sufficient to avoid a collision.

In such cases Evasive Steering Assist can:

- give an unnecessary warning or provide assistance
- not give a warning or not provide assistance

- ▶ Always pay careful attention to the traffic situation; do not rely on Evasive Steering Assist alone.
- ▶ Be ready to brake and take evasive action if necessary.
- ▶ Prevent the assistance by actively steering in non-critical driving situations.
- ▶ Drive at an appropriate speed if pedestrians are close to the path of your vehicle.

Also observe the Evasive Steering Assist system limitations.

System limitations

Active Brake Assist may be impaired or may not function in the following situations:

- In snow, rain, fog, heavy spray, if there is glare, in direct sunlight or in greatly varying light conditions.
- If the sensors are dirty, fogged up, damaged or covered.

- If the sensors are impaired due to interference from other radar sources, such as high radar reflection in covered car parks.
- If tire pressure loss or a defective tire has been detected and displayed.

The system may not react correctly:

- In complex traffic stations where objects cannot always be clearly identified.
- To pedestrians or vehicles moving quickly into the detection range of the sensors.
- To pedestrians obscured by other objects.
- If the typical outline of a person is not distinguishable from the background.
- If a pedestrian can no longer be recognized as such, e.g. due to special clothing or other objects.
- In new vehicles or after a service has been carried out on Active Brake Assist.
- On sharp bends.

Setting Active Brake Assist

Multimedia system:

↳ Vehicle ▶▶  Assistance ▶▶ Active Brake Assist

Vehicles without Driving Assistance Package:

The settings can be made after starting the vehicle.

Vehicles with Driving Assistance Package:

The settings can be made when the ignition is switched on.

- ⓘ It is recommended that you always leave Active Brake Assist switched on.

The moment of warning or intervention can be adjusted as follows:

- ▶ **Select Active Brake Assist Warning/Brake Application: Early:** your selection is retained when the vehicle is next started.
- ▶ **Select Active Brake Assist Warning/Brake Application: Medium:** your selection is retained when the vehicle is next started.

- ▶ **Select Active Brake Assist Warning/Brake Application: Late:** your selection is retained when the vehicle is next started.

- ▶ **Select Active Brake Assist Warning/Brake Application: Off:**

Vehicles without Driving Assistance Package:

The distance warning function and the autonomous braking function are deactivated. When the vehicle is next started, the middle setting is automatically selected.

Vehicles with Driving Assistance Package:

The distance warning function and the autonomous braking function are deactivated. Evasive Steering Assist is unavailable. When the ignition is next started, the middle setting is selected automatically and Evasive Steering Assist is available.

- ⓘ When Active Brake Assist is deactivated, the  symbol appears in the assistance graphic in the multifunction display.

Speed control cruise control

Function of cruise control

Cruise control accelerates and brakes the vehicle automatically in order to maintain a previously stored speed.

If you accelerate to overtake, for example, the stored speed is not deleted. If you remove your foot from the accelerator pedal after overtaking, cruise control will resume speed regulation back to the stored speed.

You can operate cruise control with the cruise control lever.

If you fail to adapt your driving style, cruise control can neither reduce the risk of an accident nor override the laws of physics. It cannot take into account road, weather or traffic conditions. Cruise control is only an aid. You are responsible for the distance to the vehicle in front, for vehicle speed, for braking in good time and for staying in your lane.

System limitations

Cruise control may be unable to maintain the stored speed on uphill gradients. The stored speed is resumed when the gradient evens out.

Do not use cruise control in the following situations:

- In traffic situations which require frequent changes of speed, e.g. in heavy traffic, on winding roads.
- On slippery roads. Accelerating can cause the drive wheels to lose traction and the vehicle could then skid.
- When visibility is poor.

Operating cruise control

⚠ WARNING Risk of accident due to unknown stored speed

If you call up the stored speed and this is lower than your current speed, the vehicle decelerates.

If you do not know the stored speed, the vehicle could decelerate unexpectedly.

- ▶ Take into account the traffic situation before calling up the stored speed.
- ▶ If the stored speed is not known, store the desired speed again.

Change into a lower gear in good time on long and steep downhill gradients. This is especially important if the vehicle is laden. By doing so, you will make use of the braking effect of the engine. This relieves the load on the brake system and prevents the brakes from overheating and wearing too quickly.

Prerequisites

- Cruise control is selected.
- ESP[®] must be switched on, but not intervening.
- The driving speed must be at least 15 mph (20 km/h).

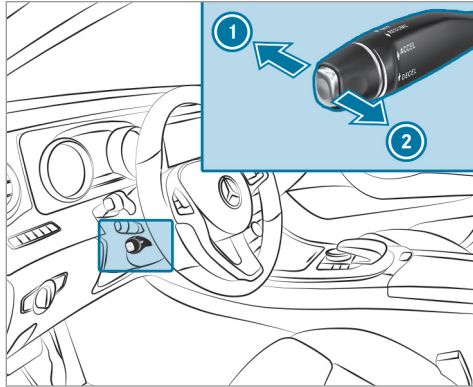

▶ To store current speed ② (once after starting the vehicle).

or

- ▶ To call up stored speed ②.
- ▶ To deactivate cruise control ①.

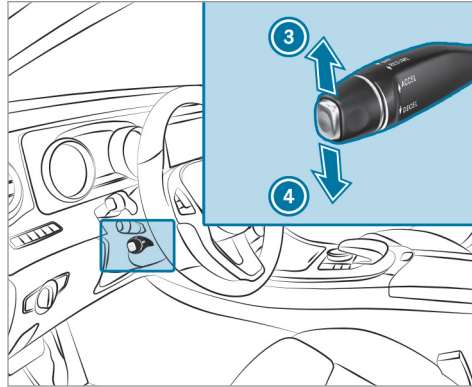

▶ Press the lever briefly: stored speed is increased ③ or reduced ④ by 1 mph (1 km/h).

or

▶ Press and hold the lever: stored speed is increased ③ or reduced ④ in 1 mph (1 km/h) increments.

or

▶ Press the lever beyond the pressure point: stored speed is increased ③ or reduced ④ by 10 mph (10 km/h).

or

▶ Press and hold lever beyond the pressure point: stored speed is increased ③ or reduced ④ in 10 mph (10 km/h) increments.

If cruise control has been deactivated, the current driven speed is adopted with ③ or ④.

- ⓘ If you brake, deactivate ESP or if ESP intervenes, cruise control is deactivated.
- ⓘ When you switch off the vehicle, the last speed stored is cleared.

Setting the speed limit for winter tires

Multimedia system:

▶ [Vehicle](#) ▶ [Vehicle Settings](#)
▶ [Winter Tires Limit](#)

▶ Select the speed or deactivate the function.

Distance Pilot DISTRONIC

Function of Distance Pilot DISTRONIC

The Distance Pilot DISTRONIC:

- Maintains the set speed and accelerates or decelerates the vehicle if the distance from the vehicle in front permits.
- Assists you in maintaining the distance from the vehicle in front and can bring your vehicle to a standstill if necessary.
- Brakes your vehicle with up to 50 % of the maximum possible braking power. If greater deceleration performance is required, a visual and acoustic warning is given and you must then intervene yourself.
- **Vehicles with the Driving Assistance Package, Parking Pilot and COMAND:** When driving in stop-start traffic, the driver is supported by an extended, automatic restart in traffic jams.
- **Vehicles with the Driving Assistance Package:** Responds in built-up areas to stationary vehicles (except bicycles, motorcy-

cles and pedestrians) if conditions are sufficient to enable detection.

If you fail to adapt your driving style, Distance Pilot DISTRONIC can neither reduce the risk of an accident nor override the laws of physics. Distance Pilot DISTRONIC cannot take into account road, weather or traffic conditions. Distance Pilot DISTRONIC is only an aid. You are responsible for the distance to the vehicle in front, for vehicle speed, for braking in good time and for staying in your lane.

If all activation conditions are met, you can activate Distance Pilot DISTRONIC during a journey or while stationary. When Distance Pilot DISTRONIC is activated, a speed is stored which the driver can increase or reduce at any time. The speed can be adjusted between 15 mph (20 km/h) and 120 mph (200 km/h).

Vehicles with the Driving Assistance Package: The speed can be adjusted between 15 mph (20 km/h) and 130 mph (210 km/h).

Vehicles with the Driving Assistance Package, Parking Pilot and COMAND: If the vehicle is stopped on a highway or a high-speed major

road, the vehicle follows the vehicle ahead for up to 30 seconds, without the driver needing to intervene. If an obstacle is detected in front of the vehicle during the driving-off procedure, a takeover warning is given. Acceleration is reduced and the driver is warned visually and acoustically.

Vehicles with the Driving Assistance Package: In conjunction with navigation systems, Distance Pilot DISTRONIC prevents prohibited overtaking on the right at speeds over 50 mph (80 km/h) in right-hand traffic and overtaking on the left in left-side traffic on highways or high-speed major roads.

If you activate the turn signal indicator to change lanes, the vehicle will accelerate more briskly to the set speed under the following conditions:

- Distance Pilot DISTRONIC is activated.
- If the driving speed is higher than 45 mph (70 km/h).
- If the traffic situation in the overtaking lane permits a safe lane change.

Drive program

The DYNAMIC SELECT switch allows you to change the driving style of Distance Pilot DISTRONIC. Depending on which drive program is selected, the driving characteristics can be geared towards fuel economy, comfort or dynamic performance (→ page 133).

System limitations

Distance Pilot DISTRONIC is active in the 0 mph (0 km/h) to 120 mph (200 km/h) speed range.

Vehicles with the Driving Assistance Package: Distance Pilot DISTRONIC is active in the 0 mph (0 km/h) to 130 mph (210 km/h) speed range.

The system may be impaired or may not function in the following situations:

- in snow, rain, fog, heavy spray, if there is glare, in direct sunlight or in greatly varying light conditions.
- if the windshield in the area of the camera is dirty, fogged up, damaged or covered.
- if the radar sensors are dirty or covered.

Do not use Distance Pilot DISTRONIC in the following situations:

- in road and traffic conditions which do not allow you to maintain a constant speed, e.g. in heavy traffic or on winding roads.
- on slippery roads. Braking or accelerating can cause the drive wheels to lose traction and the vehicle could then skid.
- when there is poor visibility, e.g. due to fog, heavy rain or snow.
- in parking garages or at toll stations.
- on roads with steep uphill or downhill gradients.

Tips

Pay particular attention in the following traffic situations. In such situations, brake if necessary. Distance Pilot will then be deactivated:

- When cornering, entering and exiting a bend.
- When not driving in the center of the lane.
- When other vehicles are changing lane.
- If there are narrow vehicles.

- If there are obstacles and stationary vehicles.
- If there is crossing traffic.

Display of Distance Pilot in the assistance graphic and in the speedometer

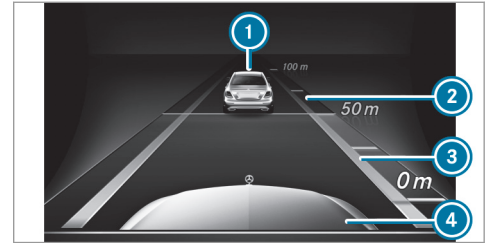

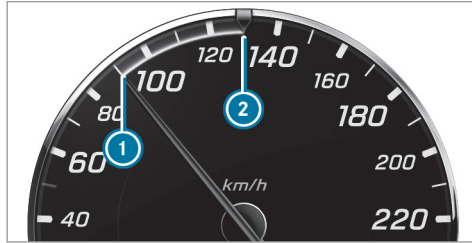

- ① Vehicle ahead
- ② Distance indicator
- ③ Set specified distance
- ④ Own vehicle



- ① Speed of vehicle ahead
- ② Stored speed

Displays in the multifunction display

When activating Distance Pilot DISTRONIC or when changing the stored speed, the new stored speed is shown for around five seconds in the multifunction display e.g. Distance Pilot DISTRONIC 50 mph (70 km/h).

If Distance Pilot DISTRONIC has been preselected, the  symbol is displayed in the multifunction display. When Distance Pilot DISTRONIC is active, the set stored speed is displayed next to the  symbol. When distance control is active, the symbol is shown in green.

Vehicles with the Driving Assistance Package: On highways or high-speed major roads the  symbol is displayed cyclically when the vehicle is ready to pull away.

Operating Distance Pilot DISTRONIC

⚠ WARNING Risk of accident if detection function of Distance Pilot DISTRONIC is impaired

The Distance Pilot DISTRONIC does not react:

- To people or animals.
- To stationary obstacles on the road, e.g. stopped or parked vehicles (vehicles without the Driving Assistance Package).
- To stationary obstacles on the road, e.g. stopped or parked vehicles, if conditions are not sufficient to enable detection (vehicles with the Driving Assistance Package).
- To oncoming vehicles and crossing traffic.

As a result, Distance Pilot DISTRONIC may neither give warnings nor intervene in such situations.

- ▶ Always carefully observe the traffic conditions and be ready to brake at all times.

⚠ WARNING Risk of accident due to limited detectability of road users and traffic situations

Distance Pilot DISTRONIC cannot always clearly identify other road users and complex traffic situations.

In these conditions, Distance Pilot DISTRONIC may:

- Give an unnecessary warning and then brake the vehicle.
 - Neither give a warning nor intervene.
 - Accelerate or brake unexpectedly.
- ▶ Continue driving with care and be ready to brake, particularly if Distance Pilot DISTRONIC warns you.

⚠ WARNING Risk of accident due to insufficient deceleration by Distance Pilot DISTRONIC

Distance Pilot DISTRONIC brakes your vehicle with up to 50 % of the maximum possible braking power. If this deceleration is not sufficient, Distance Pilot DISTRONIC alerts you with a visual and acoustic warning.

- ▶ Apply the brakes yourself in these situations and try to take evasive action.

⚠ WARNING Risk of accident due to Distance Pilot DISTRONIC still being activated when you leave the vehicle

If you leave the driver's seat while the vehicle is being braked by Distance Pilot DISTRONIC only, it can roll away in the following situations:

- If there is a malfunction in the system or in the power supply.

- If Distance Pilot DISTRONIC is deactivated with the cruise control lever, e.g. by a vehicle occupant or from outside the vehicle.
- If the electrics in the engine compartment, the battery or the fuses are tampered with.
- If the battery is disconnected.
- If the vehicle is accelerated, e.g. by a vehicle occupant.
- ▶ Always deactivate Distance Pilot DISTRONIC and secure the vehicle to prevent it from rolling away before you leave the driver's seat.

⚠ WARNING Risk of accident due to unknown stored speed

If you call up the stored speed and this is lower than your current speed, the vehicle decelerates.

If you do not know the stored speed, the vehicle could decelerate unexpectedly.

- ▶ Take into account the traffic situation before calling up the stored speed.
- ▶ If the stored speed is not known, store the desired speed again.

⚠ WARNING Risk of accident due to unexpected acceleration by Distance Pilot DISTRONIC

If Distance Pilot DISTRONIC no longer detects a vehicle in front, it may unexpectedly accelerate to the speed stored.

- This speed may be too high for a filter lane or a slip road.
- If driving in the right lane, this speed may be so high that you pass vehicles driving on the left (in countries where traffic drives on the right).
- If driving in the left lane, this speed may be so high that you pass vehicles driving on the right (in countries where traffic drives on the left).

Always carefully observe the traffic conditions and be ready to brake at all times.

⚠ WARNING Risk of accident due to Distance Pilot DISTRONIC pulling away automatically

If Distance Pilot DISTRONIC performs an automatic driving-off procedure, the vehicle may accelerate unexpectedly.

Where necessary, brake the vehicle yourself and take evasive action.

Prerequisites

- The vehicle's engine or must be switched on.
- The electric parking brake must be released.
- Parking Pilot is not being used to park the vehicle or to exit from a parking space.
- ESP® must be switched on, but not intervening.
- The transmission must be in position **D**.
- The driver door, front passenger door and the rear doors must be closed.

- The hood must be closed.

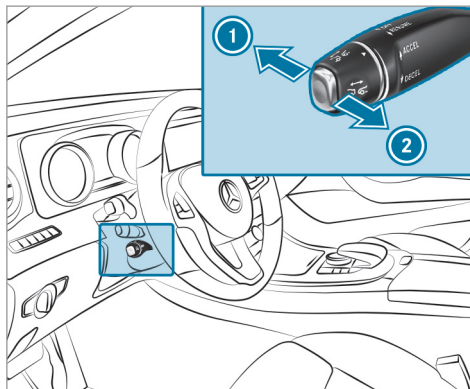

- ▶ Remove your foot from the accelerator pedal.
 - ▶ To store current speed ②.
Your vehicle adapts its speed to that of the vehicle in front, but only up to the stored speed.
- or
- ▶ To call up stored speed ②.

- ▶ To deactivate Distance Pilot DISTRONIC ①.

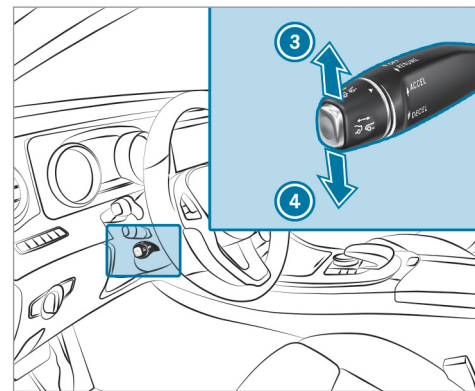

- ▶ To increase ③ or reduce ④ the speed.

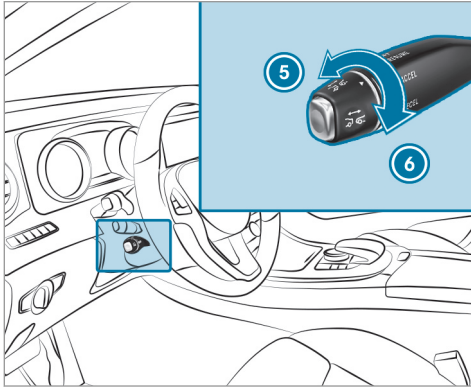

- ▶ To reduce ⑤ or increase ⑥ the specified distance from the vehicle in front.

Pulling away with Distance Pilot DISTRONIC
Requirement: a speed must have been previously stored.

- ▶ Remove your foot from the brake pedal.
- ▶ Briefly pull the cruise control lever towards you ②.

or

- ▶ Accelerate briefly.
 Your vehicle pulls away and adapts its speed to that of the vehicle in front. If no vehicle is detected in front, your vehicle accelerates to the set speed.

Collision warning

When the distance pilot is unable to sufficiently decelerate the vehicle in order to prevent approaching the vehicle in front, you will be warned visually and acoustically. An intermittent warning tone will then sound and the distance warning lamp will light up in the Instrument cluster.

- ▶ Brake immediately in order to increase the distance from the vehicle in front.

or

- ▶ Take evasive action provided it is safe to do so.

Function of Motorway Pilot

Motorway Pilot includes the following driving and driving safety systems:

- Steering Pilot with Active Lane Change Assist (→ page 163)
- Distance Pilot DISTRONIC (→ page 158)

Steering Pilot

Function of Steering Pilot

Steering Pilot is only available for vehicles with the Driving Assistance Package.

- Steering Pilot is operational at speeds up to 130 mph (210 km/h) and helps you to stay in the center of the lane by means of moderate steering interventions.
- It uses as a reference the vehicle in front or the lane markings, depending on the driven speed.
- Steering Pilot requires you as the driver, to keep your hands on the steering wheel at all times so that you are able to intervene at any time to correct the course of the vehicle and keep it in lane.

- The Steering Pilot can be overridden at any time by steering the vehicle yourself.
- If the system detects that there are no lane markings, it uses the vehicle ahead as a reference up to a speed of 80 mph (130 km/h).
- When the system is actively steering, the  symbol is shown in green in the multi-function display.

Steering Pilot system limitations

Steering Pilot has a limited steering torque for lateral guidance. In some cases, the steering intervention is not sufficient to keep the vehicle in the lane.

If detection of lane markings and vehicles ahead is impaired, Steering Pilot switches to passive mode. The  symbol in the multifunction display is shown in gray. The system provides no support in this case.

The system may be impaired or may not function in the following situations:

- If there is poor visibility, e.g. due to insufficient illumination of the road, or due to snow, rain, fog or spray.
- If there is glare, e.g. from oncoming traffic, direct sunlight or reflection from other vehicles (e.g. if the road surface is wet).
- If the windshield is dirty, fogged up, damaged or covered, for instance by a sticker, in the vicinity of the camera.
- If no, or several, unclear lane markings are present for one lane, e.g. in a construction area.
- If the lane markings are worn away, dark or covered up, e.g. by dirt or snow.
- If the distance to the vehicle in front is too small and the lane markings thus cannot be detected.
- If the lane markings change quickly, e.g. lanes branch off, cross one another or merge.
- If the road is narrow and winding.
- If there are highly variable shade conditions on the road.
- Obstacles such as traffic warning signs located on the lane or projecting out into the lane are not detected.

The system does not provide assistance in the following conditions:

- On very sharp bends.
- When towing a trailer.
- If you actively change lane without switching on the turn signal indicator.
- If you switch on the turn signal indicator and the conditions for activating Active Lane Change Assist are not fulfilled.

Information on the Steering Pilot

Steering Pilot is only an aid. You are responsible for the distance to the vehicle in front, for vehicle speed, for braking in good time and for staying in your lane. Before changing lanes, make sure that the neighboring lane is free (shoulder view).

Active Lane Change Assist

-  The availability of the following function is country-dependent.

Steering Pilot remains active even if the turn signal indicator is switched on. Steering Pilot then assists the driver when changing lanes by applying steering torques to initiate the lane change.

Assistance when changing lanes is provided if all the following conditions are met:

- You are driving on a highway or high-speed multi-lane major road with structurally separated lanes.
- The neighboring lane is free and separated by a broken lane marking.
- The driven speed is between 45 mph (75 km/h) and 110 mph (180 km/h).
- The turn signal indicator is switched on for longer than two seconds.

Steering and contact detection

Steering Pilot requires you as the driver, to keep your hands on the steering wheel at all times so that you are able to intervene at any time to correct the course of the vehicle and keep it in lane. The driver must expect a change from active to passive mode or vice versa at any time.



If you are not steering yourself or if you take your hands off the steering wheel for a prolonged period of time, the system will, depending on the situation, first alert you with a visual warning. ① appears in the multifunction display. If you are still not steering the vehicle yourself or if you have not taken hold of the steering wheel, a warning tone sounds in addition to the warning message to remind you to take control of the vehicle.

The warning message does not appear or disappears if one of the following conditions are met:

- the driver steers the vehicle.

- the driver presses a steering wheel button or operates Touch Control.

Active Emergency Stop Assist

If the driver continues to ignore the acoustic warning, Distance Pilot DISTRONIC reduces the speed. If the driver still does not respond, the vehicle is decelerated in stages to a standstill.

The driver can cancel the deceleration at any time by performing one of the following actions:

- Steering
- Braking or accelerating
- Pressing a steering wheel button or operating Touch Control
- Activating or deactivating Steering Pilot or Distance Pilot DISTRONIC

The driver must be ready to take control of the vehicle at any time.

Activating Steering Pilot

Prerequisites

- ESP® must be switched on, but not intervening.

- Distance Pilot DISTRONIC must be activated.

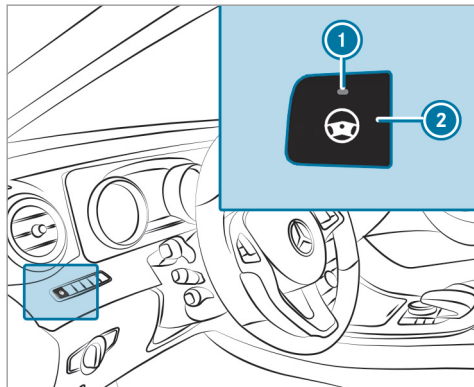

- ▶ If indicator lamp ① is off: press button ②.

HOLD function

HOLD function

The HOLD function holds the vehicle at a standstill without requiring you to depress the brake

pedal, such as when pulling away on steep slopes.

System limitations

The incline must not be greater than 30%.

Activating/deactivating the HOLD function

⚠ WARNING Risk of an accident due to the HOLD function being active when you leave the vehicle

If you leave the vehicle while only the HOLD function is braking the vehicle, the vehicle can roll away in the following situations:

- If there is a malfunction in the system or in the power supply.
- If the HOLD function is deactivated by depressing the accelerator pedal or the brake pedal, e.g. by a vehicle occupant.
- If the electrics in the engine compartment, the battery or the fuses are tampered with.
- If the battery is disconnected.

- ▶ Always deactivate the HOLD function and secure the vehicle against rolling away before leaving the vehicle.

! NOTE Damage from automatic braking

If Active Brake Assist, Distance Pilot DISTRONIC or the HOLD function is activated, the vehicle brakes automatically in certain situations.

To avoid damage to the vehicle, deactivate these systems in the following or similar situations:

- ▶ During towing
- ▶ In a car wash

Prerequisites

- The vehicle is stationary.
- The engine is running or has been automatically switched off by the ECO start/stop function.
- The electric parking brake is released.
- Distance Pilot DISTRONIC is not activated.

- **Vehicles with automatic transmission:**
The transmission is in position **D**, **R** or **N**.

Activating the HOLD function

- ▶ Depress the brake pedal and after a short time depress further until the **HOLD** display appears in the multifunction display.
- ▶ Release the brake pedal.

Deactivating the HOLD function

- ▶ Depress the accelerator pedal to pull away.
or
- ▶ Depress the brake pedal until the **HOLD** display disappears from the multifunction display.

In the following situations, the vehicle is held by the transmission position **P** or by the electric parking brake:

- When the seat belt is unfastened and the driver's door is opened.
- When the engine is switched off.
- When there is a malfunction in the system or if the power supply is insufficient.

Adaptive Damping System

The suspension with adaptive damping adjustment has the following features:

- Variable damping characteristics
- Continuous damper tuning

The damping characteristics adapt to the current operating and driving situation.

The damping is tuned individually for each wheel and is affected by the following factors:

- Your driving style, e.g. sporty
- The road surface conditions
- The drive program selected
- The vehicle load

The drive program can be adjusted using the DYNAMIC SELECT switch.

AIR BODY CONTROL

AIR BODY CONTROL function

AIR BODY CONTROL comprises:

- Air suspension with variable spring rate
- Automatic level control system
- Speed-dependent lowering to reduce fuel consumption
- Manual level adjustment
- ADS PLUS (Adaptive Damping System with constant damping force adjustment)
- DYNAMIC SELECT switch and level button

Available suspension settings

Drive program	Characteristics
C (Comfort)	<ul style="list-style-type: none">• Comfortable suspension tuning• Normal level• When driving at speeds above 77 mph (125 km/h) the vehicle is lowered by 0.6 in (15 mm).• When driving at speeds below 49 mph (80 km/h), the vehicle is raised again.
E (Economy)	<ul style="list-style-type: none">• Comfortable suspension tuning• Normal level• When driving at speeds above 77 mph (125 km/h) the vehicle is lowered by 0.6 in (15 mm).• When driving at speeds below 49 mph (80 km/h), the vehicle is raised again.
S (Sport)	<ul style="list-style-type: none">• Firmer suspension tuning• The vehicle is lowered by 0.6 in (15 mm) compared to the normal level.• The vehicle is not lowered any further if you are traveling at higher speeds.
S+ (Sport Plus)	<ul style="list-style-type: none">• Even firmer suspension tuning• The vehicle is lowered by 0.6 in (15 mm) compared to the normal level.• The vehicle is not lowered any further if you are traveling at higher speeds.

Setting the vehicle level

- ⚠ WARNING** Risk of accident because vehicle level is too high

If you drive at a higher vehicle level, the driving characteristics may be impaired due to the higher vehicle center of gravity.

The vehicle may tip over more quickly on a bend, for example.

- ▶ Always select as low a vehicle level as possible and adapt your driving style accordingly.

- ⚠ WARNING** Risk of entrapment from vehicle lowering

When lowering the vehicle, people could become trapped if their limbs are between the vehicle body and the tires or underneath the vehicle.

- ▶ Make sure no one is underneath the vehicle or in the immediate vicinity of the wheel arches when you lower the vehicle.

- ⚠ WARNING** Risk of entrapment from vehicle lowering

Vehicles with AIR BODY CONTROL or level control system: When you unload luggage or leave the vehicle, the vehicle first rises slightly and then returns to the set level shortly afterwards.

You or anyone else in the vicinity of the wheel arches or the underbody could thus become trapped.

The vehicle can also be lowered after being locked.

- ▶ When leaving the vehicle, make sure that nobody is in the vicinity of the wheel arches or the underbody.

Prerequisites

- The vehicle's engine must be switched on.
- The vehicle must not be moving faster than 49 mph (80 km/h).

Raising the vehicle

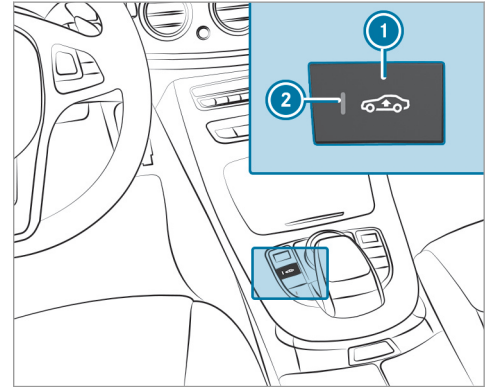

- ▶ Press button **1**. Indicator lamp **2** lights up.
 - **Vehicles without 4MATIC:** The vehicle is raised by 0.9 in (25 mm) compared to the normal level.

- **Vehicles with 4MATIC:** The vehicle is raised by 1.3 in (35 mm) compared to the normal level.

Your selection is saved.

The vehicle is lowered again in the following situations:

- You are driving faster than 49 mph (80 km/h).
- You are driving between 37 mph (60 km/h) and 49 mph (80 km/h) for approximately three minutes.
- You select a drive program using the DYNAMIC SELECT switch.

The vehicle is adjusted to the height of the last active drive program.

Lowering the vehicle

- ▶ Press button ①.
- Indicator lamp ② goes out. The vehicle is adjusted to the height of the last active drive program.

PARKTRONIC

Functions of PARKTRONIC

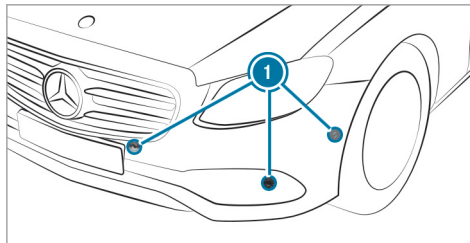

PARKTRONIC is an electronic parking assistance system with ultrasonic sensors. It monitors the area around your vehicle using six sensors ① in the front bumper and six sensors in the rear bumper. PARKTRONIC indicates visually and audibly the distance between your vehicle and an object.

PARKTRONIC is only an aid. It is not a substitute for your attention to the immediate surroundings. The responsibility for safe maneuvering and parking remains with you. Make sure that there

are no persons, animals or objects in range while maneuvering and parking.

In the standard setting, an intermittent warning tone sounds beginning at a distance of 1.0 ft (0.3 m) to an obstacle. A continuous tone sounds beginning at a distance of 0.7 ft (0.2 m). You can set the warning tone in the multimedia system so that it will sound earlier at greater distances (→ page 172).

If PARKTRONIC is deactivated, Parking Pilot is unavailable.

PARKTRONIC display in the multimedia system

If Parking Pilot is deactivated and an obstacle is detected in the path of the vehicle, a pop-up window of PARKTRONIC ① appears in the multimedia system at speeds up to 5 mph (10 km/h).

Vehicles with Parking Pilot and reversing camera:



Vehicles with Parking Pilot and 360° Camera:



System limitations

PARKTRONIC does not take into account the following obstacles:

- Obstacles below the detection range, e.g. persons, animals or objects.
- Obstacles above the detection range, e.g. overhanging loads, overhangs or truck loading ramps.

The sensors must be free of dirt, ice and slush. Otherwise, they may not function correctly. Clean the sensors regularly, taking care not to scratch or damage them.

Vehicles with a trailer hitch: PARKTRONIC is deactivated for the rear zone when you establish an electrical connection between your vehicle and a trailer.

Deactivates/activates PARKTRONIC

! **NOTE** Risk of an accident from objects at close range

PARKTRONIC may not detect certain objects at close range.

▶ When parking the vehicle, pay particular attention to any objects which are above or below the sensors, e.g. flowerpots or drawbars. The vehicle or other objects could otherwise be damaged.

Make sure that there are no persons, animals or objects in range while maneuvering and parking. If indicator lamp ① is not lit, PARKTRONIC is active.

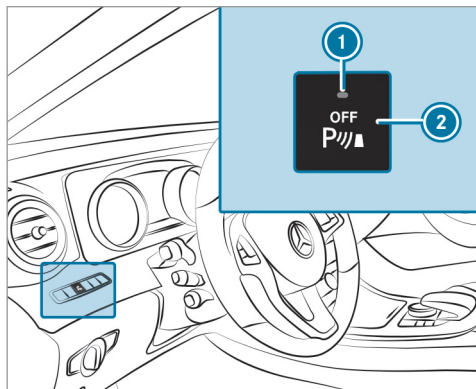

▶ Press button ②.

- ① Depending on the vehicle's equipment, the button may also be located in the center console.
- ② PARKTRONIC is automatically activated when the vehicle is started.

Adjusting the PARKTRONIC warning tones

Multimedia system:

- ▶ Vehicle ▶ Assistance
- ▶▶ Parking Pilot ▶▶ Set Warning Tones

Adjusting the volume of the warning tones

- ▶ Select **Warning Tone Volume**.
- ▶ Adjust the value.

Adjusting the pitch of the warning tones

- ▶ Select **Warning Tone Pitch**.
- ▶ Adjust the value.

Specifying the starting point for the warning tones

You can specify whether the PARKTRONIC warning tones should commence when the vehicle is further away from an obstacle.

- ▶ Select **Warn Early**.
- ▶ Activate or deactivate the function.

Activating/deactivating audio fadeout

You can specify whether the volume of a media source in the multimedia system is to be

reduced when PARKTRONIC gives an audible warning.

- ▶ Select **Audio Fadeout During Warning Tones**.
- ▶ Activate or deactivate the function.

Reversing camera

Function of the reversing camera

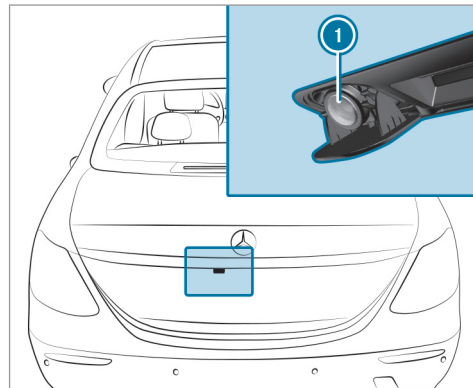

When you engage reverse gear, the image from reversing camera ① is shown in the multimedia system. Dynamic guide lines show the path the vehicle will take with the steering wheel in its current position. This helps you to orientate yourself and to avoid obstacles when backing up.

The reversing camera is only an aid. It is not a substitute for your attention to the immediate surroundings. The responsibility for safe maneuvering and parking remains with you. Make sure that there are no persons, animals or objects in range while maneuvering and parking.

You can select from the following views:

- Normal view
- Wide-angle view
- Trailer view

The area behind the vehicle is displayed as a mirror image, as in the inside rearview mirror.

System limitations

The reversing camera will not function or will only partially function in the following situations:

- If the trunk lid or tailgate is open.
- if there is heavy rain, snow or fog.
- If the light conditions are poor, e.g. at night.
- If the camera lens is obstructed, dirty or fogged up. Observe the notes on cleaning the reversing camera (→ page 271).
- if the rear of your vehicle is damaged. In this case, have the camera position and setting checked at a qualified specialist workshop.

The field of vision and other functions of the reversing camera may be restricted due to additional accessories on the rear of the vehicle (e.g. license plate bracket or bicycle rack).

Vehicles without Parking Pilot

The following camera views are available in the multimedia system:

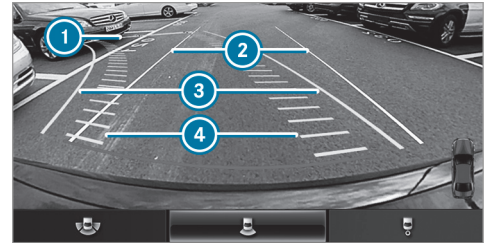

Normal view

- ① Yellow guide line at a distance of approximately 13 ft (4.0 m) from the rear area
- ② White guide line without turning the steering wheel, vehicle width including the outside mirrors (static)
- ③ Yellow guide line for the vehicle width including the outside mirrors, for current steering wheel angle (dynamic)
- ④ Yellow lane marking tires at current steering wheel angle (dynamic)



- ⑤ Yellow guide line at a distance of approximately 3.3 ft (1.0 m) from the rear area
- ⑥ Vehicle center axle (marker assistance)
- ⑦ bumper
- ⑧ Red guide line at a distance of approximately 12 in (0.3 m) from the rear area



Wide-angle view

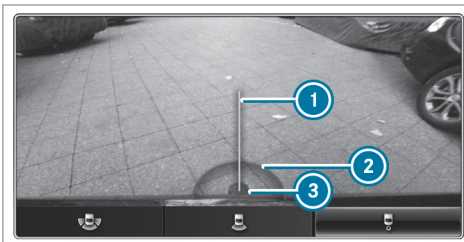

Trailer view

- ① Yellow guide line, locating aid

- ② Red guide line at a distance of approximately 12 in (0.3 m) from the rear area
- ③ Ball head of the trailer hitch

Vehicles with Parking Pilot

The following camera views are available in the multimedia system:

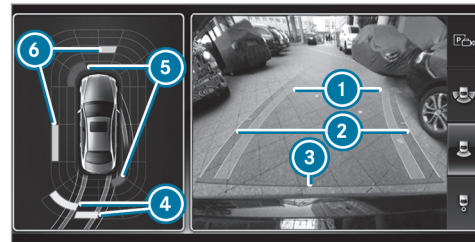

Normal view

- ① Yellow lane marking tires at current steering wheel angle (dynamic)
- ② Yellow guide line, vehicle width including outside mirrors (dynamic)
- ③ Red guide line at a distance of approximately 12 in (0.3 m) from the rear area

- ④ PARKTRONIC yellow warning display: obstacles are a sufficient distance away (3.3 ft (1.0 m) or less)
- ⑤ PARKTRONIC red warning display: obstacles are very close (1.0 ft (0.3 m) or less)
- ⑥ PARKTRONIC orange warning display: obstacles are a medium distance away (between 1.0 ft (0.3 m) and 2.0 ft (0.6 m))
- ⓘ If PARKTRONIC is deactivated, the warning display fades out.



Wide-angle view

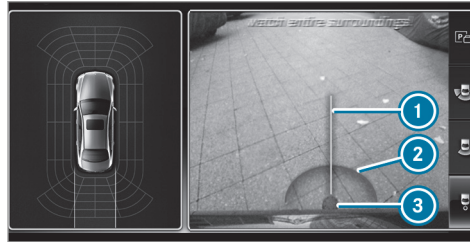

Trailer view

- ① Yellow guide line, locating aid
- ② Red guide line at a distance of approximately 12 in (0.3 m) from the rear area
- ③ Ball head of the trailer hitch

360° Camera

Function of the 360° Camera

The 360° Camera is a camera system that consists of four cameras. The cameras cover the immediate vehicle surroundings. The system assists you, e.g. when parking or at exits with reduced visibility.

The 360° Camera is only an aid. It is not a substitute for your attention to the immediate surroundings. The responsibility for safe maneuvering and parking remains with you. Make sure that there are no persons, animals or objects in range while maneuvering and parking.

The system evaluates images from the following cameras:

- Reversing camera
- Front camera
- Two side cameras in the outside mirrors

Views of the 360° Camera

You can select from different views:



- ① Wide-angle view, front
- ② Top view with image from the front camera
- ③ Top view with images from the side cameras in the outside mirrors
- ④ Wide-angle view, rear
- ⑤ Top view with image from the reversing camera
- ⑥ Top view with trailer view

Top view



- ① Lane indicating the route the vehicle will take with the steering wheel in its current position
- ② PARKTRONIC yellow warning display: obstacles are a sufficient distance away (3.3 ft (1.0 m) or less)
- ③ Your vehicle from above

If the distance to the object lessens, the color of warning display ② changes. From a distance of 1.0 ft (0.3 m) the warning display is shown in red.

- ⓘ If PARKTRONIC is deactivated, the warning display fades out.

Guide lines

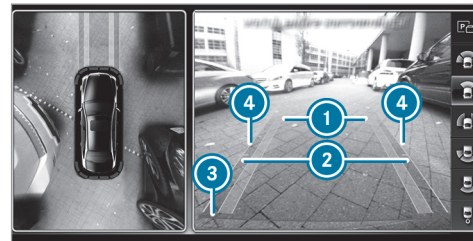

- ① Yellow lane marking tires at current steering wheel angle (dynamic)
- ② Yellow guide line, vehicle width including outside mirrors (dynamic)
- ③ Red guide line at a distance of approximately 12 in (0.3 m) from the rear area
- ④ Mark at a distance of approx. 3.3 ft (1.0 m)
- ⓘ The guide lines in the multimedia system display show the distances to your vehicle. The distances only apply to road level. In trailer mode, the guide lines are shown at the level of the trailer hitch.

System limitations

The 360° Camera will not function or will only partially function in the following situations:

- If the doors are open.
- If the trunk lid or tailgate is open.
- If there is heavy rain, snow or fog.
- If the light conditions are poor, e.g. at night.
- If the camera lens is obstructed, dirty or fogged up.
- If the vehicle components in which the cameras are installed are damaged. In this event, have the camera position and setting checked at a qualified specialist workshop.

Do not use the 360° Camera under such circumstances. You could otherwise injure others or collide with objects when parking the vehicle.

On vehicles with height-adjustable suspension or if the vehicle is carrying a heavy load, leaving the standard height can result in inaccuracies in the guide lines and in the display of the generated images, depending on technical conditions.

The field of vision and other functions of the camera system may be restricted due to additional accessories on the rear of the vehicle (e.g. license plate bracket, bicycle rack).

See the notes on cleaning the 360° Camera (→ page 271).

Selecting a view for the 360° camera

The **Activation by R gear** function is selected in the multimedia system.

- ▶ Engage reverse gear.
- ▶ In the multimedia system, select the desired view.

Switching the rear view camera automatic mode on/off

Multimedia system:

- ▶ **Vehicle** ▶ **Assistance** ▶ **Parking Pilot** ▶ **Auto. Rear View Cam.**
- ▶ Activate or deactivate the function.

Opening the camera cover of the rear view camera

Multimedia system:

- ▶ **Vehicle** ▶  **Assistance**
- ▶ **Parking Pilot**
- ▶ Select **Open Camera Cover.**

- ▶  The camera cover closes automatically after some time or after an ignition cycle.

Assigning the camera as a favorite

You can call up the camera view directly in the multimedia system by assigning it as a favorite.

- ▶ Press the  button on the touchpad or controller.
The main functions are displayed.
- ▶ On the touchpad, swipe down twice or slide the controller down twice.
The Favorites menu appears.
- ▶ Select **Reassign.**
- ▶ Select **Vehicle.**
- ▶ Select **Camera.**

Parking Pilot

Function of Parking Pilot

Parking Pilot is an electronic parking assistance system which uses ultrasound and is automatically activated when driving forwards. The system is operational at speeds of up to approximately 22 mph (35 km/h). While in operation, the system independently locates and measures parallel and perpendicular parking spaces on both sides of the vehicle in the direction of travel. If Parking Pilot is activated, suitable parking spaces are displayed in the multimedia system. Symbol  appears in the multifunction display. The arrows show which side of the road free parking spaces are located. The parking space and parking direction can be selected as desired. Parking Pilot calculates a suitable vehicle path and assists you in the parking and exiting procedure. Parking Pilot changes gear, accelerates, brakes and steers the vehicle.

Parking Pilot is only an aid. It is not a substitute for your attention to the immediate surroundings. The responsibility for safe maneuvering, parking in and driving out of parking spaces

remains with you. Make sure that no persons, animals or objects are in the maneuvering area.

Parking Pilot is canceled if one of the following actions is carried out:

- You deactivate PARKTRONIC.
- You switch off Parking Pilot.
- You begin steering.
- You apply the parking brake.
- You engage drive range .
- ESP[®] intervenes.

Parking Pilot system limits

Objects located above or below the detection range of Parking Pilot are not detected when the parking space is being measured. These are also not taken into account when the parking procedure is calculated, e.g. overhanging loads, overhangs or loading ramps of trucks or the boundaries of parking spaces. In some circumstances, Parking Pilot may therefore guide you into the parking space prematurely.

 **WARNING** Risk of accident due to objects located above or below the detection range of Parking Pilot

If there are objects above or below the detection range, the following situations may arise:

- Parking Pilot may steer too early.
- The vehicle may not stop in front of these objects.

This could cause a collision.

 In these situations, do not use Parking Pilot.

Snowfall or heavy rain may lead to a parking space being measured inaccurately. Parking spaces that are partially occupied by trailer drawbars might not be identified as such or be measured incorrectly. Only use Parking Pilot on level, high-grip ground.

Do not use Parking Pilot, for example, in the following situations:

- In extreme weather conditions such as ice or packed snow or in heavy rain.

- If you are transporting a load that protrudes beyond the vehicle.
- If the parking space is on a downhill or uphill incline.
- If you have installed snow chains.

Parking Pilot may also display parking spaces that are not suitable for parking, e.g.:

- Parking spaces where parking is prohibited.
- Parking spaces on unsuitable surfaces.

Parking Pilot will not assist you with parking spaces at right angles to the direction of travel in the following situations:

- If two parking spaces are located immediately next to each other.
- If the parking space is directly next to a low boundary, e.g. a low curb.

Parking Pilot will not assist you with parking spaces parallel or at right angles to the direction of travel in the following situations:

- If the parking space is on a curb.

- If the parking space is bordered by an obstacle, e.g. a tree, a post or a trailer.

Parking with Parking Pilot

⚠ WARNING Risk of accident due to objects located above or below the detection range of Parking Pilot

If there are objects above or below the detection range, the following situations may arise:

- Parking Pilot may steer too early.
- The vehicle may not stop in front of these objects.

This could cause a collision.

▶ In these situations, do not use Parking Pilot.

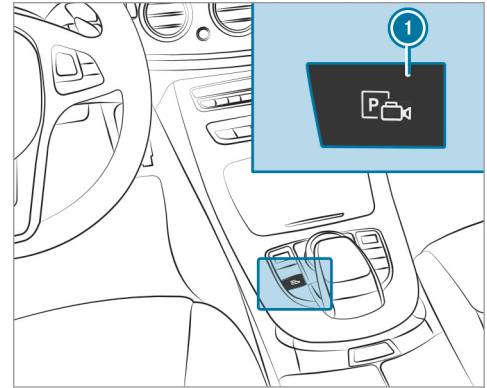

▶ Press the ① button. The Parking Pilot view appears on the display of the multimedia system. Area ② displays detected parking spaces ④ and vehicle path ③.



- ▶ If you have driven past a suitable parking space: bring the vehicle to a standstill.
- ▶ Select desired parking space ④.
- ▶ Where necessary, select the parking direction: forwards or reverse. Vehicle path ③ is shown, depending on the selected parking space and parking direction.
- ▶ Confirm the selected parking space.

⚠ WARNING Risk of accident due to vehicle swinging out while parking or pulling out of a parking space

While parking or pulling out of a parking space, the vehicle swings out and can drive onto areas of the oncoming lane.

This could cause you to collide with objects or other road users.

- ▶ Pay attention to objects and other road users.
- ▶ Where necessary, stop the vehicle or cancel the parking procedure with Parking Pilot.

- ▶ If, for example, the message **Engage Reverse Gear** appears in the display of the multimedia system: select the corresponding transmission position. The vehicle drives automatically into the selected parking space. On completion of the parking procedure, the **Parking Pilot Finished, Take Control of the Vehicle** display message appears. Further maneuvering may still be necessary.

- ▶ After completion of the parking procedure, safeguard the vehicle against rolling away. If stipulated by legal requirements: turn the wheels towards the curb.

- ⓘ You can stop the vehicle and change the transmission position during the parking procedure. The system then calculates a new vehicle path. The parking procedure can then be continued. If no new vehicle path is available, the transmission position will be changed again.

Exiting a parking space with Parking Pilot

Prerequisite

You can only exit a parking space with Parking Pilot if you have previously parked the vehicle with Parking Pilot.

Please note that you are responsible for the vehicle during the entire parking procedure.

- ▶ Start the vehicle.

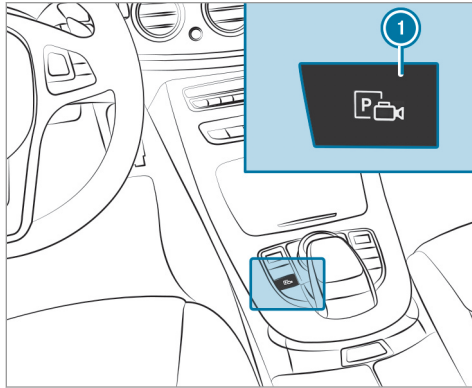

- ▶ Press button ①. The Parking Pilot view appears on the display of the multimedia system.

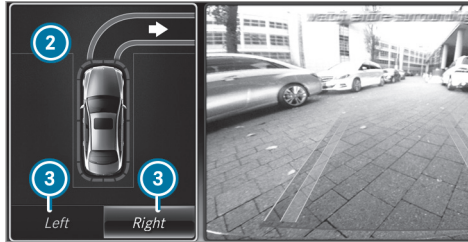

- ▶ If the vehicle has been parked at right angles to the direction of travel: in area ②, select direction of travel ③.
- ▶ Confirm to start the exiting process.

⚠ WARNING Risk of accident due to vehicle swinging out while parking or pulling out of a parking space

While parking or pulling out of a parking space, the vehicle swings out and can drive onto areas of the oncoming lane.

This could cause you to collide with objects or other road users.

- ▶ Pay attention to objects and other road users.
- ▶ Where necessary, stop the vehicle or cancel the parking procedure with Parking Pilot.

- ▶ If, for example, the message **Engage Forward Gear** appears in the display of the multimedia system: select the corresponding transmission position. The vehicle automatically moves out of the parking space.

As soon as the **Parking Pilot Finished, Take Control of the Vehicle** message appears in the display of the multimedia system, you must accelerate, brake, steer and change gears yourself again.

Drive Away Assist

Drive Away Assist can prevent collisions when pulling away. If an obstacle is detected in the direction of travel, the vehicle's speed is briefly reduced to 1 mph (2 km/h). If a critical situation is detected, a warning symbol appears on the camera image of the multimedia system.

A risk of a collision may arise in the following situations, for example:

- If the driver mixes up the accelerator and brake pedals.
- If the wrong gear is selected.

The Drive Away Assist function is active under the following conditions:

- If PARKTRONIC is activated.
- Every time the gear is changed to **R** or **D** when the vehicle is at a standstill.
- If the obstacle is less than 3.3 ft (1.0 m) away.
- If the maneuvering assistance function is activated in the multimedia system.

Drive Away Assist is unavailable on inclines and when driving with a trailer.

Cross Traffic Alert

Vehicles with Blind Spot Assist: Drivers can also be warned of any crossing traffic when backing up out of a parking space. If a critical situation is detected, a warning symbol appears on the camera image of the multimedia system.

If the driver does not respond to the warning, the vehicle's brakes can be applied automatically. To do this, the function uses the radar sensors in the bumper. The area adjacent to the vehicle is continually monitored.

If the radar sensors are obstructed by vehicles or other objects, detection is not possible.

The Cross Traffic Alert function is active under the following conditions:

- Blind Spot Assist is activated.
- The vehicle is backing up at walking pace.
- The maneuvering assistance function is activated in the multimedia system.

Activating/deactivating maneuvering assistance

Multimedia system:

➔ Vehicle ➔  Assistance
 ➔➔ Parking Pilot ➔➔ Maneuvering Assist.

▶ Switch the function on or off .

ATTENTION ASSIST

Function of ATTENTION ASSIST

ATTENTION ASSIST assists you on long, monotonous journeys, e.g. on highways and trunk roads. If ATTENTION ASSIST detects indicators of fatigue or increasing lapses in concentration on the part of the driver, it suggests taking a break.

ATTENTION ASSIST is only an aid. It cannot always detect fatigue or lapses in concentration until too late. The system is not a substitute for a well-rested and attentive driver. On long journeys, take regular breaks in good time that allow for adequate recuperation.

You can choose between two settings.

- **Standard:** normal system sensitivity
- **Sensitive:** higher system sensitivity. The driver is warned earlier and the attention level detected by ATTENTION ASSIST is adapted accordingly.

If drowsiness or increasing lapses in concentration are detected, the **ATTENTION ASSIST: Take a Break!** warning appears in the Instrument Display. You can acknowledge the message and

take a break where necessary. If you do not take a break and ATTENTION ASSIST continues to detect increasing lapses in concentration, you will be warned again after a minimum of 15 minutes.



You can have the following status information for ATTENTION ASSIST displayed in the assistance menu of the on-board computer:

- the length of the journey since the last break.
- the attention level determined by ATTENTION ASSIST.

if ATTENTION ASSIST is unable to calculate the attention level and cannot issue a warning, the **System Suspended** message appears.

If a warning is given in the Instrument Display, the multimedia system offers to search for a rest area. You can select a rest area and start navigation to this rest area. This function can be activated and deactivated in the multimedia system.

If ATTENTION ASSIST is deactivated, the  symbol appears in the assistance graphic in the Instrument Display when the engine is running. ATTENTION ASSIST is activated automatically when the engine is re-started. The last selected sensitivity level remains stored.

System limitations

ATTENTION ASSIST is active in the 37 mph (60 km/h) to 124 mph (200 km/h) speed range.

The functionality of ATTENTION ASSIST is restricted, and warnings may be delayed or not occur at all in the following situations:

- If you have been driving for less than 30 minutes.

- If the road condition is poor (uneven road surface or potholes).
- If there is a strong side wind.
- If you adopt a sporty driving style (high cornering speeds or high rates of acceleration).
- If the Steering Pilot function of DISTRONIC is active.
- If the time has been set incorrectly.
- If you change lanes and vary your speed frequently.

The ATTENTION ASSIST tiredness assessment is deleted and restarted when continuing the journey in the following situations:

- If you switch off the engine.
- If you unfasten your seat belt and open the driver's door (e.g. change drivers or take a break).

Activating/deactivating ATTENTION ASSIST

Multimedia system:

→ Vehicle →  Assistance → Attention Assist

Selection options

▶ Select **Standard**, **Sensitive** or **Off**.

Blind Spot Assist and Active Blind Spot Assist**Function of Blind Spot Assist and Active Blind Spot Assist**

Blind Spot Assist uses two lateral, rear-facing radar sensors to monitor the area up to 130 ft (40 m) behind your vehicle and 10 ft (3 m) directly next to your vehicle.

If a vehicle is detected at speeds above approximately 5 mph (8 km/h) and this vehicle subsequently enters the monitoring range directly next to your vehicle, the warning lamp in the outside mirror lights up red.

If a vehicle is detected close to your vehicle in the lateral monitoring range and you switch on the turn signal indicator in the corresponding

direction, an acoustic warning signal sounds once. The red warning lamp in the outside mirror flashes. If the turn signal indicator remains on, all other detected vehicles are indicated only by the flashing of the red warning lamp.

If you overtake a vehicle quickly, no warning is given.

⚠ WARNING Risk of accident despite Blind Spot Assist

Blind Spot Assist does not react to vehicles approaching and overtaking you at a greatly different speed.

As a result, Blind Spot Assist cannot warn drivers in this situation.

▶ Always pay careful attention to the traffic situation and maintain a safe distance at the side of the vehicle.

Blind Spot Assist and Active Blind Spot Assist are only aids. They may fail to detect some vehicles and are no substitute for attentive driving. Always ensure that there is sufficient distance to the side for other road users and obstacles.

System limitations

The detection capability of Blind Spot Assist can be restricted in the following situations:

- If the sensors are dirty or obscured.
- When there is poor visibility, e.g. due to fog, heavy rain, snow or spray.
- If narrow vehicles are within the monitoring range, e.g. bicycles.

Warnings may be issued in error when driving close to crash barriers or similar solid lane borders. Warnings may be interrupted when driving alongside long vehicles, for example, trucks, for a prolonged period.

Blind Spot Assist is not operational when reverse gear is engaged.

Brake application of Active Blind Spot Assist

If Active Blind Spot Assist detects a risk of a side impact in the monitoring range, a course-correcting brake application is carried out. This is designed to help you avoid a collision.

The course-correcting brake application is available in the speed range between approximately 20 mph (30 km/h) and 125 mph (200 km/h).

⚠ WARNING Risk of accident despite brake application of Active Blind Spot Assist

A course-correcting brake application cannot always prevent a collision.

- ▶ Always steer, brake or accelerate yourself, especially if Active Blind Spot Assist warns you or makes a course-correcting brake application.
- ▶ Always maintain a safe distance at the sides.

⚠ WARNING Risk of accident despite Active Blind Spot Assist

Blind Spot Assist does not react to the following:

- Overtaking vehicles closely on the side, placing them in the blind spot area
- Vehicles approaching and overtaking you at a very different speed

As a result, Active Blind Spot Assist may neither give warnings nor intervene in such situations.

- ▶ Always pay careful attention to the traffic situation and maintain a safe distance at the side of the vehicle.



If a course-correcting brake application occurs, the red warning lamp flashes in the outside mirror and warning tone sounds. In addition, a display ① indicating the danger of a side collision appears in the multifunction display.

In rare cases, the system may make an inappropriate brake application. This brake application

may be interrupted at any time if you steer slightly in the opposite direction or accelerate.

System limitations

Either a course-correcting brake application appropriate to the driving situation, or none at all, may occur in the following situations:

- There are vehicles or obstacles, e.g. crash barriers, on both sides of your vehicle.
- A vehicle approaches too closely on the side.
- You have adopted a sporty driving style with high cornering speeds.
- You clearly brake or accelerate.
- A driving safety system intervenes, such as ESP® or Active Brake Assist.
- ESP® is deactivated.
- Tire pressure loss or a defective tire has been detected.
- When driving with a trailer, the electrical connection to the trailer hitch has been correctly established.

Activating/deactivating Blind Spot Assist or Active Blind Spot Assist

Multimedia system:

→ Vehicle → Assistance → Blind Spot Assist

▶ Activate or deactivate the function.

Active Lane Keeping Assist

Function of Active Lane Keeping Assist

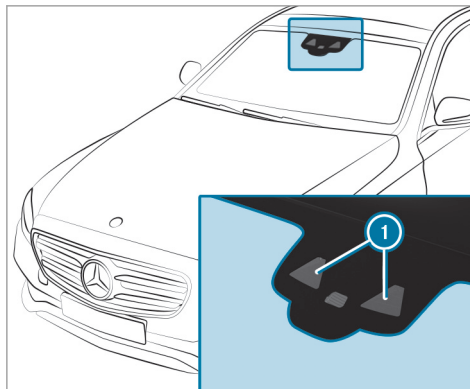

Active Lane Keeping Assist monitors the area in front of your vehicle by means of multifunction camera ①.

You are warned by vibration pulses in the steering wheel in the following circumstances:

- Active Lane Keeping Assist detects lane markings.
- A front wheel passes over the lane markings.

Whether a warning is issued and when this occurs also depends on the selected sensitivity setting (standard or adaptive).

If you fail to adapt your driving style, Active Lane Keeping Assist can neither reduce the risk of an accident nor override the laws of physics. It cannot take into account road, weather or traffic conditions. Active Lane Keeping Assist is only an aid. You are responsible for the distance to the vehicle in front, for vehicle speed, for braking in good time and for staying in lane.

Vehicles with Lane Tracking Package: If the lane markings are solid lines and you do not react to the warning, a lane-correcting brake application can bring the vehicle back into the original lane.

Vehicles with Driving Assistance Package or Driving Assistance Plus Package: If you do not

react to the warning, a lane-correcting brake application can bring the vehicle back into the original lane. In the case of a broken lane marking being detected, a brake application will only be made if a vehicle has been detected in the adjacent lane. Oncoming vehicles, overtaking vehicles and vehicles in adjacent lanes can be detected.

The brake application is available in the speed range between 40 mph (60 km/h) and 120 mph (200 km/h).



If a lane-correcting brake application occurs, display  appears in the multifunction display.

System limitations

No lane-correcting brake application occurs in the following situations:

- You clearly and actively steer, brake or accelerate.
- You have switched on the turn signal indicator.
- A driving safety system intervenes, such as ESP®, Active Brake Assist or Active Blind Spot Assist.
- You have adopted a sporty driving style with high cornering speeds or high rates of acceleration.
- ESP® is deactivated.
- When driving with a trailer, the electrical connection to the trailer has been correctly established.
- If a loss of tire pressure or a defective tire has been detected and displayed.

The system may be impaired or may not function in the following situations:

- There is poor visibility, e.g. due to insufficient illumination of the road, highly variable shade conditions, or due to rain, snow, fog or heavy spray.
- There is glare, e.g. from the sun, reflections or oncoming traffic.
- There is dirt on the windshield in the vicinity of the multifunction camera or the camera is fogged up, damaged or obscured.
- No or several, unclear lane markings are present for one lane, e.g. in a construction area.
- The lane markings are worn, dark or covered.
- The distance to the vehicle in front is too small and the lane markings thus cannot be detected.
- The lane markings change quickly, e.g. lanes branch off, cross one another or merge.
- The road is very narrow and winding.

Vehicles with Driving Assistance Package or Driving Assistance Plus Package: Active Lane

Keeping Assist uses radar sensors to monitor several areas around the vehicle. If the radar sensors in the rear bumper are dirty or covered with snow, the system may be impaired or may not function. If an obstacle in the lane in which you are driving has been detected, no lane-correcting brake application occurs.

Activating Active Lane Keeping Assist

⚠ WARNING Risk of accident despite warning from Active Lane Keeping Assist

A lane-correcting brake application cannot always bring the vehicle back into the original lane.

- ▶ Always steer, brake or accelerate yourself, especially if Active Lane Keeping Assist warns you or makes a lane-correcting brake application.

⚠ WARNING Risk of accident despite intervention of Active Lane Keeping Assist

Active Lane Keeping Assist does not detect traffic conditions or road users. In very rare

cases, the system may make an inappropriate brake application, e.g. after intentionally driving over a solid lane marking.

The brake application can be interrupted at any time if you steer slightly in the opposite direction.

- ▶ Always make sure that there is sufficient distance to the side for other traffic or obstacles.

⚠ WARNING Risk of accident despite Lane Keeping Assist

Lane Keeping Assist cannot always clearly detect lane markings.

In such cases, Lane Keeping Assist can:

- give an unnecessary warning
 - not give a warning
- ▶ Always pay particular attention to the traffic situation and keep within the lane, especially if Active Lane Keeping Assist alerts you.

Prerequisite

The driving speed is at least 40 mph (60 km/h).

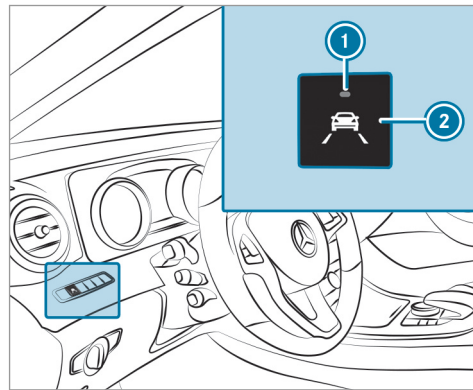

- ▶ Press button ②. If indicator lamp ① lights up, Lane Keeping Assist is activated. When lane markings are detected, the lines in the assistance graphic are shown in white.

Sensitivity of Active Lane Keeping Assist

With the standard or adaptive setting, you can influence when the warning vibration of Lane Keeping Assist takes place.

In both the standard and adaptive settings, no warning vibration occurs in the following situations:

- You have switched on the turn signal indicator.
- A driving safety system intervenes, such as ABS, BAS or ESP®.

In the adaptive setting, there will also be no warning vibration in the following situations:

- The vehicle is accelerated or braked considerably.
- You steer actively, e.g. swerve to avoid an obstacle or change lane quickly.
- You cut the corner on a sharp bend.

Setting the sensitivity of Active Lane Keeping Assist

Multimedia system:

↳ Vehicle ▶  Assistance ▶ Spurhalte-Assistent

Selection options

▶ Select **Adaptive** or **Standard**.

Instrument Display overview

⚠ WARNING Risk of accident due to an instrument display malfunction

If the instrument display has failed or malfunctioned, you cannot recognize function restrictions applying to safety relevant systems.

The operating safety of your vehicle may be impaired.

- ▶ Drive on carefully.
- ▶ Have the vehicle checked immediately at a qualified specialist workshop.

If the operating safety of your vehicle is impaired, park the vehicle safely as soon as possible. Contact a qualified specialist workshop.

Instrument Display (standard)

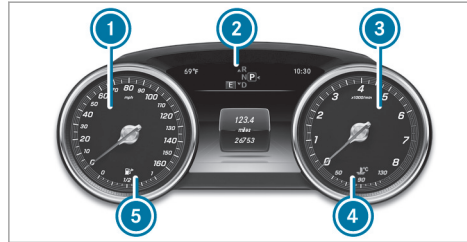

Instrument Display in the Widescreen Cockpit

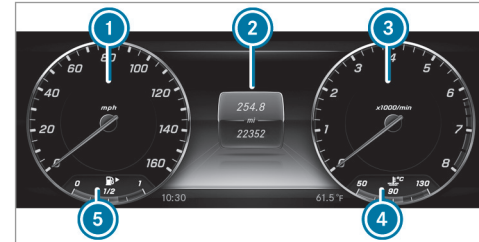

- ① Speedometer
- ② Multifunction display
- ③ Tachometer
- ④ Coolant temperature display
- ⑤ Fuel level and fuel filler flap location indicator

The segments in speedometer ① indicate the system status for the following:

- Cruise control (→ page 156)
- Distance Pilot DISTRONIC (→ page 158)

! **NOTE** Engine damage due to excessively high engine speeds

The engine will be damaged if you drive with the engine in the overrevving range.

▶ Do not drive with the engine in the overrevving range.

The fuel supply is interrupted to protect the engine when the red band in tachometer ③ (overrevving range) is reached.

During normal operating conditions, coolant temperature display ④ may rise to 248 °F (120 °C).

! **WARNING** Danger of burns when opening the engine hood

If you open the engine hood when the engine has overheated or during a fire in the engine compartment, you could come into contact with hot gases or other escaping operating fluids.



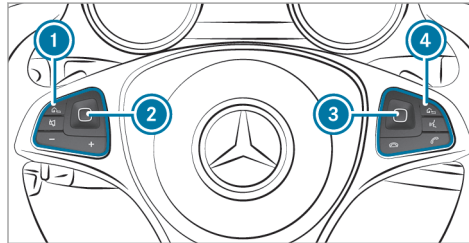

▶ Before opening the engine hood, allow the engine to cool down.

▶ In the event of a fire in the engine compartment, keep the engine hood closed and call the fire service.

Overview of the buttons on the multifunction steering wheel



① Button group:

-  Main menu and back button (on-board computer)
-  Switches sound off/on
-  Increases the volume
-  Decreases the volume

② Touch Control (on-board computer)

③ Touch Control (multimedia system)

④ Button group:

 Main menu and back button (multimedia system)

 LINGUATRONIC or Voice Control System

 Makes/accepts a call

 Rejects/ends a call

Operating the on-board computer

! **WARNING** Risk of distraction from information systems and communications equipment

If you operate information and communications equipment integrated in the vehicle when driving, you will be distracted from the traffic situation. This could also cause you to lose control of the vehicle.

▶ Only operate this equipment when the traffic situation permits.

▶ If you cannot be sure of this, stop the vehicle whilst paying attention to road and traffic conditions and operate the equipment with the vehicle stationary.

You must observe the legal requirements for the country in which you are currently driving when operating the on-board computer.

ⓘ The on-board computer displays appear in the multifunction display (→ page 193).

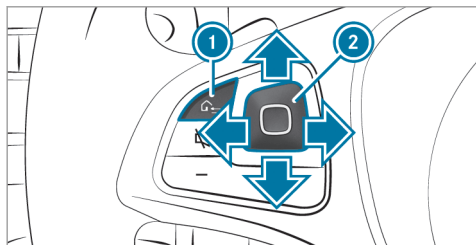

The on-board computer is operated using Touch Control ② and back button ① on the left-hand side of the steering wheel.

The following menus are available in the Instrument Display (standard):

- Service
- Assistance
- Trip
- Navigation
- Radio
- Media
- Phone
- HUD

The following menus are available in the Instrument Display in the Widescreen Cockpit:

- Service
- DriveAssist
- Trip
- Navigation
- Radio
- Media
- Phone
- Disp. Content

- **Head-up Disp.**

The menu can be called up from the menu bar in the multifunction display.



- ▶ **To call up the menu bar:** press the back button.
- ▶ **To scroll through the menu bar:** swipe to the left or right-hand side of Touch Control.
- ▶ **To call up the menu or confirm the selection:** press the left-hand side of Touch Control.
- ▶ **To scroll through displays or lists in the menu:** swipe upwards or downwards on the left-hand side of Touch Control.

- ▶ **To call up the submenu or confirm the selection:** press the left-hand side of Touch Control.
- ▶ **To exit the submenu:** press the back button.

If you are browsing a submenu and you press and hold the back button, the menu bar appears.

Displays in the multifunction display

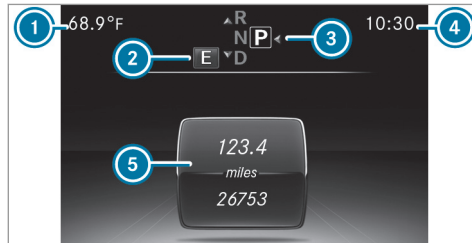

- ① Outside temperature
- ② Drive program
- ③ Transmission position (→ page 134)

- ④ Time
- ⑤ Display section

Further displays in the multifunction display:

- ↑ Gearshift recommendation (→ page 137)
- ← P → Parking Pilot
- ⊞ Cruise control (→ page 156)
- ⊞ Distance Pilot DISTRONIC (→ page 158) (→ page 163)
- ⊞ Steering Pilot (→ page 163)
- HOLD HOLD function (→ page 166)
- ⊞ Adaptive Highbeam Assist (→ page 112)

Adjusting the instrument lighting

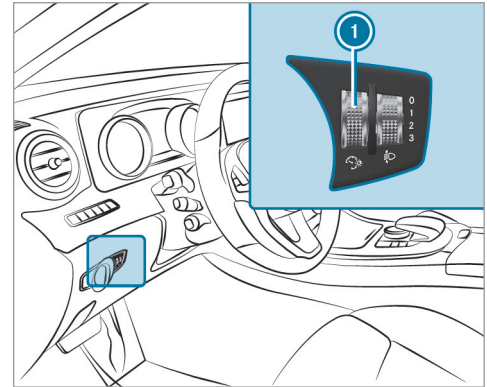

- ▶ Turn brightness control ① up or down. The lighting of the instrument display and in the controls in the vehicle interior is adjusted.

Menus and submenus

Functions in the Service menu of the on-board computer

On-board computer:

→ Service

- ① The spelling may differ in the main menu displayed. Therefore, observe the menu overview for the Instrument Display in the Wide-screen Cockpit (→ page 191).

▶ **To select the function:** swipe upwards or downwards on the left-hand side of Touch Control.

▶ Press the left-hand side of Touch Control.

Functions in the **Service** menu:

- Message memory (→ page 336)
- **DEF:** DEF range
- **Tire Pressure:**
 - Checking the tire pressure with the tire pressure monitoring system (→ page 301)
 - Restarting the tire pressure monitoring system (→ page 302)

- **ASSYST PLUS:** calling up the service due date (→ page 261)

Calling up the Assistance graphic display

On-board computer:

→ Assistance

- ① The spelling may differ in the main menu displayed. Therefore, observe the menu overview for the Instrument Display in the Wide-screen Cockpit (→ page 191).



The following displays are available from the Assistance graphic menu:

- Assistance graphic
- Attention level (→ page 182)

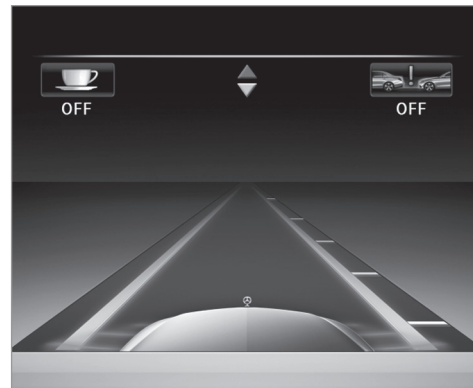
▶ **To switch between the displays:** swipe upwards or downwards on the left-hand side of Touch Control.



Status displays in the Assistance graphic:

-  OFF: ATTENTION ASSIST deactivated
-  OFF: Active Brake Assist deactivated
- Light lane markings: Active Lane Keeping Assist activated
- Green lane markings: Active Lane Keeping Assist active

- Gray radar waves next to vehicle: Blind Spot Assist activated
- Green radar waves next to vehicle: Blind Spot Assist active
- Display of Distance Pilot DISTRONIC (→ page 158)

Calling up displays in the Trip menu

On-board computer:

→ Trip

- ① The spelling may differ in the main menu displayed. Therefore, observe the menu overview for the Instrument Display in the Wide-screen Cockpit (→ page 191).

▶ **To select a display:** swipe upwards or downwards on the left-hand side of Touch Control.

Displays in the Trip menu:

- Standard display
 - A recuperation display is also available for certain engines.

- If there is only a small amount of fuel left in the fuel tank, the display shows a vehicle being refueled instead of the range.

- ECO display (→ page 133)
- Trip computer **From Start** and **From Reset**
- Digital speedometer

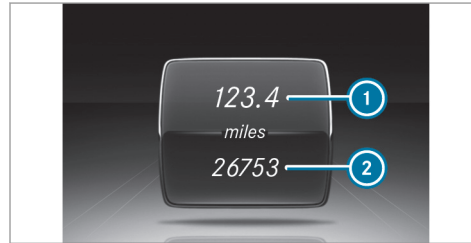

Standard display (example)

- ① Trip distance
- ② Total distance



Trip computer (example)

- ① Total distance
- ② Driving time
- ③ Average speed
- ④ Average fuel consumption

Resetting values in the Trip menu of the on-board computer

On-board computer:



- ① The spelling may differ in the main menu displayed. Therefore, observe the menu overview for the Instrument Display in the Wide-screen Cockpit (→ page 191).

You can reset the values of the following functions:

- Trip distance
- "From start" trip computer and ECO display
- "From reset" trip computer

▶ **To select the function to be reset:** swipe upwards or downwards on the left-hand side of Touch Control.

▶ Press the left-hand side of Touch Control.

▶ Select **Yes**.

▶ Press the left-hand side of Touch Control.

If you press and hold the left-hand side of Touch Control, the function will be reset immediately.

Calling up navigation instructions in the on-board computer

On-board computer:



- ① The spelling may differ in the main menu displayed. Therefore, observe the menu overview for the Instrument Display in the Wide-screen Cockpit (→ page 191).

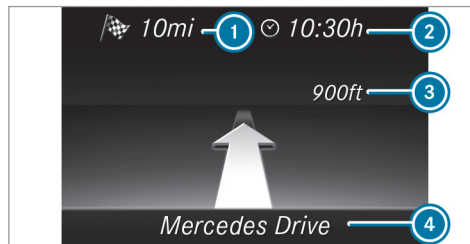

Example: no change of direction announced

- ① Distance to the next destination
- ② Estimated arrival time
- ③ Distance to the next change of direction
- ④ Current road

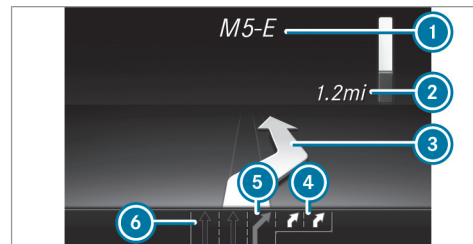

Example: change of direction announced

- ① Road into which the change of direction leads
- ② Distance to the change of direction
- ③ Change-of-direction symbol
- ④ Recommended lane and new lane during a change of direction (white)
- ⑤ Possible lane
- ⑥ Lane not recommended (dark gray)

Further possible displays in the **Navigation** menu:

- **Direction of Travel:** display of direction of travel and road currently being traveled on.

- **New Route...or Calculating Route...:** a new route is calculated.
- **Road Not Mapped:** the road is unknown, e.g. newly built roads.
- **No Route:** no route could be calculated to the selected destination.
-  : you have reached the destination or an intermediate destination.

In the **Navigation** menu, you can also start navigation to one of the previous destinations:

- ▶ Press the left-hand side of Touch Control.
- ▶ **To select the target:** swipe upwards or downwards on the left-hand side of Touch Control.
- ▶ Press the left-hand side of Touch Control. Route guidance starts.

If route guidance has already been activated, a request will appear asking whether you wish to end the current route guidance.

- ▶ Select **Yes**.
- ▶ Press the left-hand side of Touch Control. Route guidance starts.

Selecting radio stations using the on-board computer

On-board computer:



- ① The spelling may differ in the main menu displayed. Therefore, observe the menu overview for the Instrument Display in the Wide-screen Cockpit (→ page 191).



- ① Frequency range
- ② Channel with preset position
- ③ Name of track
- ④ Name of artist
- ⑤ Genre

- ▶ **To select a radio station:** swipe upwards or downwards on the left-hand side of Touch Control.

Selecting the frequency range or station preset

- ▶ Press the left-hand side of Touch Control.
- ▶ **To select the frequency range/station preset:** swipe upwards or downwards on the left-hand side of Touch Control.
- ▶ Press the left-hand side of Touch Control.

Media playback using the on-board computer

On-board computer:



- ① The spelling may differ in the main menu displayed. Therefore, observe the menu overview for the Instrument Display in the Wide-screen Cockpit (→ page 191).

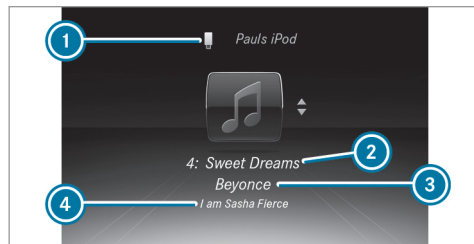

- ① Media source
- ② Current track and track number
- ③ Name of artist
- ④ Name of album

▶ **To change tracks in the active media source:** swipe upwards or downwards on the left-hand side of Touch Control.

Changing the media source

- ▶ Press the left-hand side of Touch Control.
- ▶ **To select a media source:** swipe upwards or downwards on the left-hand side of Touch Control.

▶ Press the left-hand side of Touch Control.

Dialing telephone numbers using the on-board computer

Requirements:

- The mobile phone is connected to the multi-media system.

On-board computer:

➔ Phone

- ① The spelling may differ in the main menu displayed. Therefore, observe the menu overview for the Instrument Display in the Wide-screen Cockpit (→ page 191).

⚠ WARNING Risk of distraction from information systems and communications equipment

If you operate information and communications equipment integrated in the vehicle when driving, you will be distracted from the traffic situation. This could also cause you to lose control of the vehicle.

- ▶ Only operate this equipment when the traffic situation permits.
- ▶ If you cannot be sure of this, stop the vehicle whilst paying attention to road and traffic conditions and operate the equipment with the vehicle stationary.

When telephoning, you must observe the legal requirements for the country in which you are currently driving.

The most recent telephone connections (dialed, received and missed calls) are displayed in the **Phone** menu.

- ▶ **To select a telephone number:** swipe upwards or downwards on the left-hand side of Touch Control.
- ▶ Press the left-hand side of Touch Control. The telephone number is dialed.

The following displays may appear instead of the telephone numbers dialed:

- **Please Wait...:** the application is starting. When a Bluetooth® connection is not being established, the menu for authorizing and

connecting a mobile phone is displayed in the multimedia system .

- **Updating data...:** the call list is being updated.
- **Importing Contacts...:** the mobile phone contacts are being imported.

Setting display content

On-board computer:

↳ **Disp. Content**

i This function is only available for vehicles with a widescreen cockpit.

You can select the following display content:

- Tachometer (display settings CLASSIC and Sport)
- Power meter (display settings CLASSIC and Sport)
- Date (display setting Progressive only)
- Navigation displays
- ECO display
- Consumption

▶ **To select display content:** swipe upwards or downwards on the left-hand side of Touch Control.

▶ Press the left-hand side of Touch Control. The selected display content appears on the right-hand side of the instrument display.

Adjusting the Head-up Display settings in the on-board computer

On-board computer:

↳ **HUD**

i The spelling may differ in the main menu displayed. Therefore, observe the menu overview for the Instrument Display in the Widescreen Cockpit (→ page 191).

The following Head-up Display settings can be adjusted:

- **Position**
- **Brightness**
- **Display Content**

▶ **To select the setting:** swipe upwards or downwards on the left-hand side of Touch Control.

▶ Press the left-hand side of Touch Control.

▶ **To set the value:** swipe upwards or downwards on the left-hand side of Touch Control.

▶ Press the left-hand side of Touch Control.

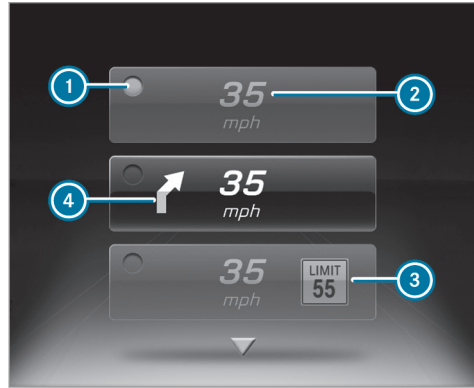

- ① Currently selected setting
- ② Digital speedometer
- ③ Traffic Sign Assist
- ④ Navigation displays

Head-up Display

Function of the Head-up Display

The Head-up Display projects information from the navigation system and the driver assistance system above the dashboard into the driver's field of vision.

Display elements

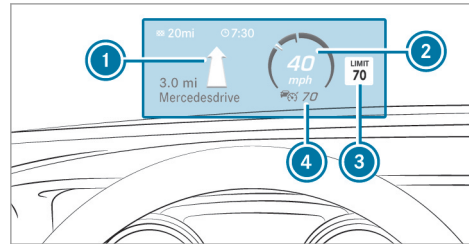

- ① Navigation messages
- ② Current speed
- ③ Detected instructions and traffic signs
- ④ Set speed in the driver assistance system (e.g. cruise control)

System limitations

The visibility is influenced by the following conditions:

- Seat position
- Positioning of the display image
- Light conditions
- Wet roads
- Objects on the display cover
- Polarization in sunglasses

ⓘ If parts of the display fade in the event of extreme sunlight, switch the head-up display off and on again.

Switching the Head-up Display on/off

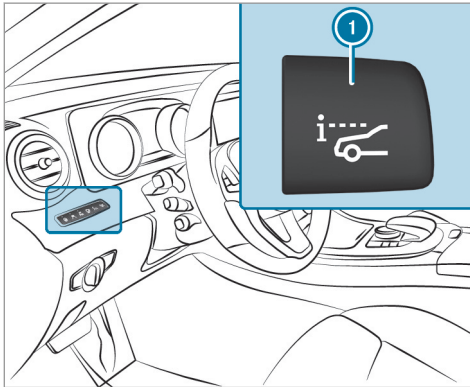

► Press button ①.

Overview and operation

Overview of the multimedia system

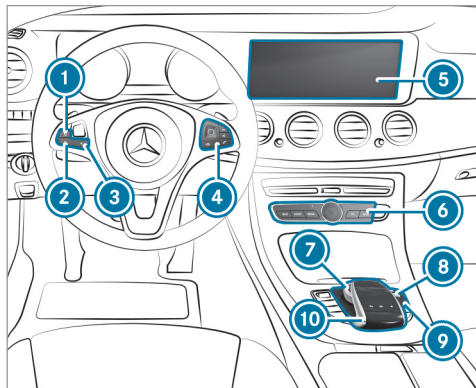

- ① Switches the sound on or off
- ② Decreases the volume
- ③ Increases the volume
- ④ Touch Control
- ⑤ Media display

- ⑥ **NAVI**, **RADIO**, **MEDIA**, **TEL**, buttons, calls up main functions
- ⑦ Controller
- ⑧ Control knob, adjusts volume and switches the sound on or off
- ⑨ button, switches the multimedia system on or off
- ⑩ Touchpad

Touch Control ④, controller ⑦ and touchpad ⑩ are central controls.

Notes on the media display

! NOTE Scratching of the display

The display has a highly sensitive, high-gloss surface. There is a risk of it becoming scratched.

Avoid touching the display.

Observe the notes on cleaning.

Observe the notes on caring for the interior (→ page 273).

Automatic temperature-controlled switch-off feature: if the temperature is too high, the brightness is initially reduced automatically. The media display may then switch off completely for a while.

- ⓘ If you are wearing polarized sunglasses, it may be difficult to read the media display.

Central controls overview

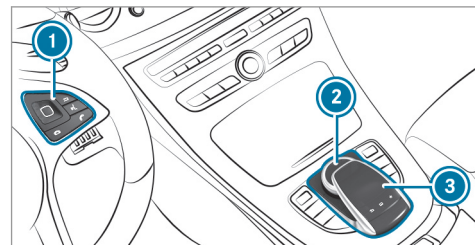

- ① Touch Control
- ② Controller
- ③ Touchpad

Touch Control

Operating Touch Control

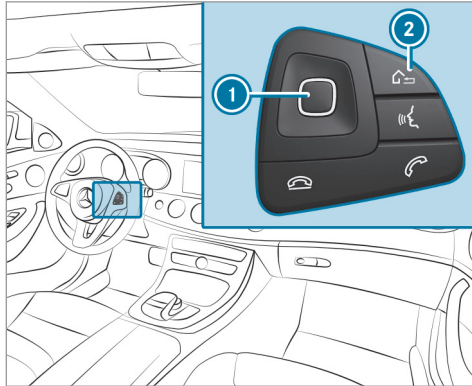

- ▶ **To select a menu item:** swipe up, down, left or right on Touch Control ①.
- ▶ Press Touch Control ①.
- ▶ **To open a list:** press Touch Control ①.
- ▶ **To close a list:** press the ② button.

- ▶ **To call up the menu list/favorites:** hold button ②.
- ▶ **To move the digital map:** swipe in any direction.

Setting the sensitivity

Multimedia system:

→ System ▶▶ Entry ▶▶ Touch Control Sensitivity



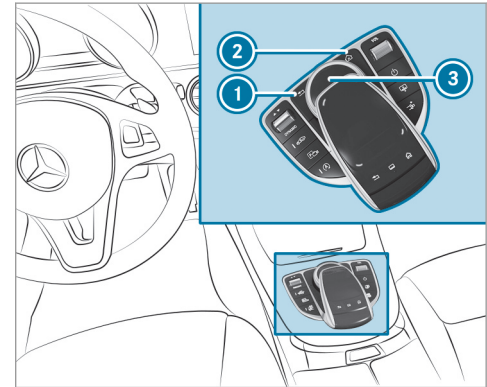

- ▶ Select **Fast**, **Medium** or **Slow**.

Operating the controller



- ① button, to return to the previous display (press briefly), to call up the basic menu (press and hold)
- ② button, to call up main functions and favorites
- ③ Controller

Controller operating options:

- ▶ Turn  left or right.
- ▶ Slide  left or right.
- ▶ Slide  up or down.
- ▶ Slide  diagonally.
- ▶ Press  briefly or press and hold.



Touchpad

Operating the touchpad

Requirement:

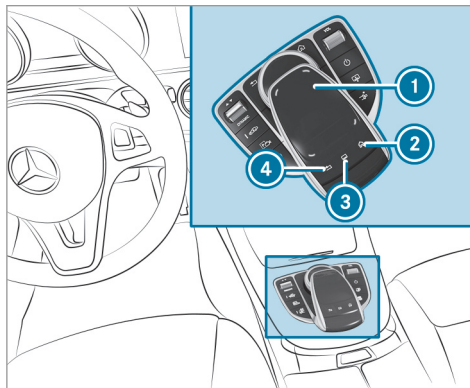
For vehicles with a controller: the touchpad is switched on (→ page 205).



- ① Touchpad
- ②  button, calls up main functions and favorites
- ③  button, calls up the audio menu
- ④  button, returns to the previous display

You can navigate in menus and lists via touch-sensitive surface ① by using a **single-finger swipe**.

- ▶ **To select the menu item:** swipe up, down, left or right.
- ▶ Press touchpad ①.
- ▶ **To open or close lists:** swipe left or right.
- ▶ **To move the digital map:** swipe in any direction.

Use the following functions with a two-finger swipe:

- ▶ **To call up the menu bar:** swipe down with two fingers.
- ▶ **To zoom in and out of the map:** move two fingers together or apart.

Setting the sensitivity

Multimedia system:

 System  Entry

- ▶ Select **Touchpad Sensitivity**.
- ▶ Select **Fast**, **Medium** or **Slow**.

Handwriting recognition: switching the read-aloud function on/off

Multimedia system:

→ System → Audio

- ▶ Activate or deactivate Read Out Handwriting Recognition.

Handwriting recognition: selecting an input language

- ▶ Press the touchpad when entering characters.
- ▶ Select .
- ▶ Select an input language.

Main functions

Calling up main functions

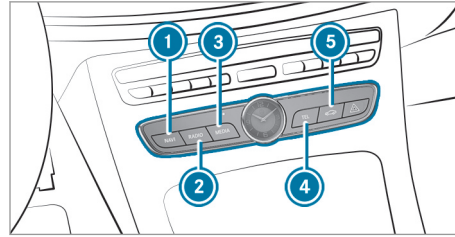

- ▶ ① **NAVI** button, switches navigation on
- ▶ ② **RADIO** button, switches the radio on
- ▶ ③ **MEDIA** button, switches the audio source on
- ▶ ④ **TEL** button, switches telephone mode on
- ▶ ⑤  button, calls up vehicle functions

Alternatively:

- ▶ When the basic menu of a main function is shown, press the  button.

- ▶ **To select a main function:** swipe left or right on the touchpad.
- ▶ Press the touchpad.

Calling up lists and menus on the multimedia system

Calling up a list

- ▶ Call up a main function (→ page 205) (→ page 205).
- ▶ **To open a list:** swipe left on the touchpad. The list is opened.
- ▶ **To select a menu item:** swipe up or down on the touchpad.
- ▶ Press the touchpad.

Favorites

Overview of favorites

Favorites offer you quick access to frequently used applications. It is possible to create a total of 20 favorites.

The following functions are available:

- add **pre-defined favorites** from the following categories:
 - Navigation
 - Phone
 - Media
 - Radio
 - Connect
 - Vehicle
 - System
- add **your own favorites**
- rename a favorite
- move a favorite
- delete a favorite
- restore all Favorites settings

Calling up favorites

- ▶ Press the  button. The main functions are displayed.
- ▶ Navigate downwards once.

Leaving the Favorites menu

- ▶ Press the  button.

Adding a favorite

Adding a pre-defined favorite

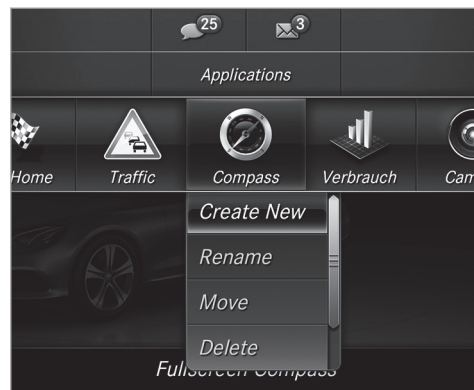

- ▶ Press the  button. The main functions are displayed.

- ▶ Navigate downwards twice. The Favorites menu appears.
- ▶ Select **Reassign**. The categories are displayed.
- ▶ Select a category. The favorites are displayed.
- ▶ Select a favorite.
- ▶ Add a favorite at the desired position. If a favorite has already been added at this position, it will be overwritten.

Adding your own favorite (example)

- ▶ Select **Vehicle**.
- ▶ Select **Full Screen: Consumption**.
- ▶ Press and hold the  button until the favorites are displayed.
- ▶ Add a favorite at the desired position.

Renaming a favorite

- ▶ Press the  button. The main functions are displayed.
- ▶ Navigate downwards once.
- ▶ Select a favorite.

- ▶ Navigate downwards once.
The Favorites menu appears.
- ▶ Select **Rename**.
- ▶ Enter characters.
- ▶ **To confirm the entry:** select **ok**.

Moving a favorite

- ▶ Press the **Home** button.
The main functions are displayed.
- ▶ Navigate downwards once.
- ▶ Select a favorite.
- ▶ Navigate downwards once.
The Favorites menu appears.
- ▶ Select **Move**.
- ▶ Move the favorite to the desired position.

Deleting a favorite

- ▶ Press the **Home** button.
The main functions are displayed.
- ▶ Navigate downwards once.
- ▶ Select a favorite.
- ▶ Navigate downwards once.
The Favorites menu appears.

- ▶ **To delete:** select **Delete**.
- ▶ Select **Yes**.
- ▶ **To restore all favorites:** select **Reset All**.
A prompt appears.
- ▶ Select **Yes**.
Favorites will be restored to factory settings.

Switching the sound on/off

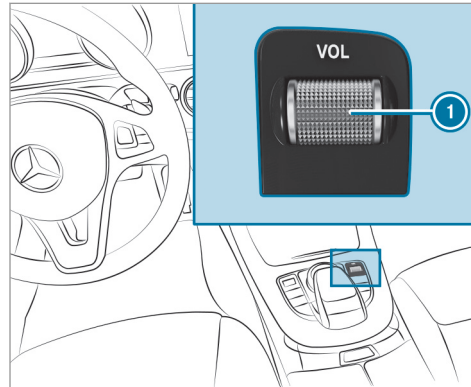

- ▶ **To switch off:** press control knob **1**.
The **Speaker** symbol appears in the status line.
You will also hear traffic announcements and navigation announcements even when the sound is muted.
- ▶ **To switch on:** change the media source or adjust the volume.

Adjusting the volume

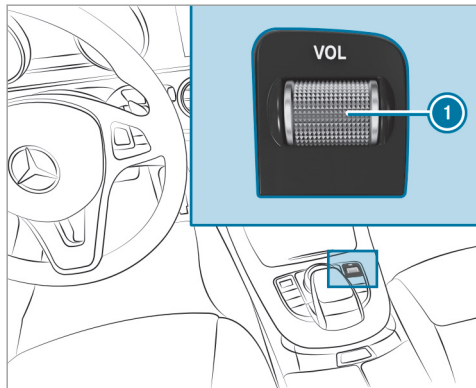

- ▶ Turn control knob ❶.
The volume of the current radio or media source is set. You can set the volume of other sound sources separately. Adjust this in the following situations:
 - during a traffic announcement
 - during a navigation announcement

- The volume of the navigation announcement changes in accordance with the volume of the current media source.
 - during a telephone call
- ▶ **Alternatively:** select **System**.
 - ▶ Select **Sound**.
 - ▶ Select volume settings.
 - ▶ Set the volume.

Entering characters

Using the character input function

The following functions are available:

- selecting a character in the character bar.
- writing a character on the touchpad.

Character input can be started with a control and resumed with another.

- ▶ **On the Touch Control and controller:** select a character in the character bar. Depending on the destination entered, the following is available:
 - the full set of characters

- characters which are useful for the current input string

Other characters are grayed out.

- ▶ **On the touchpad:** select a character in the character bar.

or

- ▶ Write the characters on the touch-sensitive surface of the touchpad. Handwriting recognition supports you by means of character suggestions and a read-aloud function.

Characters can be entered using the following methods:









- using a keyword search for a track or artist
- connecting the mobile phone to the multimedia system by entering the passkey
- entering a phone number
- entering a web address

Entering characters using the controller

Entering characters

- ▶ Turn **[⊙]**, slide **←⊙→** or **↑⊙↓** and press the controller.

Use the following editing functions:

-  or 
Changes to upper-case or lower-case letters
- 
Changes to digits and symbols
- 
Changes the language
- 
Selects the input line
- 
Moves the cursor within the input line
- 
Deletes a character or an entry
- 
Cancels character entry

Deleting a character or an entry

- ▶ **To delete a character:** when  is highlighted, press the controller.

- ▶ **To delete an entry:** when  is highlighted, press and hold the controller until the entry has been deleted.

Confirming an entry

- ▶ Select .

Entering characters on the touchpad

Entering characters

- ▶ Use one finger to write characters on the surface.
The character is entered in the input line. If different interpretations are possible, character suggestions are displayed.





Selecting a character suggestion

- ▶ **Vehicles without a controller:** swipe up or down on the touchpad.
- ▶ **Vehicles with a controller:** turn the controller.
- ▶ Press the touchpad.
- ▶ Resume character input.

The following editing functions can be used:

-  or 

Changes to upper-case or lower-case letters

- 
Changes to digits and symbols
- 
Changes the language
- 
Selects the input line
Moves the cursor within the input line
- 
Cancels character entry

Selecting the input line

- ▶ Select .
- ▶ Swipe up or down.

Moves the cursor within the input line

- ▶ Select .
- ▶ Swipe to the left or right.

Deleting characters

- ▶ When an input line is selected, swipe left.

Confirming an entry

- ▶ Press the touchpad.

System settings**Display****Configuring display settings**

Multimedia system:

→  System ▶ Display and Designs

Designs

- ▶ Select **Designs**.
- ▶ Select **Sport**, **Classic** or **Progressive**.

Additional display area

Depending on the vehicle, various items of additional information can be shown. The additional display area comprises the left-hand or right-hand third of the display.

- ▶ Select **Additional Disp. Area**.

The following display content can be selected:

- **Dynamic**
- **Navigation Map**

- **Energy Flow**
- **Consumption**
- **Time and Date**

Display brightness

- ▶ Select **Display Brightness**.
- ▶ Select a brightness value.

Switching the display on/off

- ▶ **Off**: select **Display off**.
- ▶ Switch on setting.
- ▶ **On**: e.g. press the **TEL** button.

Display design

- ▶ Select **Day/Night Design**.
- ▶ Select **Automatic**, **Day Design** or **Night Design**.

Time and date**Setting the time and date automatically**

Multimedia system:

→  System ▶ Time and Date
▶ Automatic Time Settings

The correct time is required for the following functions:

- route guidance with time-dependent traffic guidance
 - calculation of expected time of arrival
- ▶ Activate or deactivate the function.

Setting the time zone

Multimedia system:

→  System ▶ Time and Date ▶ Time Zone:

A list of countries is displayed.

- ▶ Select a country ●.
Depending on the country, time zones are displayed.
- ▶ Select a time zone.
The time zone set is displayed after **Time Zone**.

Setting Daylight Saving Time (Summer)

The [Automatic Summer Time](#) and [Daylight Saving Time](#) options cannot be selected in all countries.

Multimedia system:

↳  System ▶ Time and Date

Automatic

▶ Activate or deactivate [Automatic Summer Time](#).

Manual

- ▶ Select [Daylight Saving Time](#).
- ▶ Select [On](#) or [Off](#).

Setting the time and date format

Multimedia system:

↳  System ▶ Time and Date ▶ Set Format

- ▶ Set the date and time format •.

Setting the time manually

Requirement:

The [Automatic Time Settings](#) function is deactivated or is not supported in a time zone.

Multimedia system:

↳  System ▶ Time and Date ▶ Set Time

- ▶ Set the hours.
- ▶ Navigate to the right to set the minutes.
- ▶ Set the minutes.
- ▶ Confirm changes when exiting the menu.

The date is set automatically via GPS.

Bluetooth®

Bluetooth® settings

Bluetooth® technology is a standard for short-range wireless data transfer up to approximately 32.8 ft (10 m). You can use Bluetooth® to connect your mobile phone to the multimedia system and use the following functions, for example:

- hands-free system with access to the following options:
 - contacts (→ page 224)
 - call lists (→ page 226)

- text messages (→ page 227)

- Internet connection (→ page 233)
- listening to music via Bluetooth® audio (→ page 249)
- transferring business cards (vCards) into the vehicle

Bluetooth® is a registered trademark of Bluetooth Special Interest Group (SIG) Inc.

ⓘ Internet connection via Bluetooth® is not available in all countries.

Activating/deactivating Bluetooth®

Multimedia system:

↳  System ▶ Connectivity

- ▶ Activate or deactivate Bluetooth.

Wi-Fi

Wi-Fi connection overview

You can use Wi-Fi to establish a connection with a Wi-Fi network and to access the Internet or any other network device.

The following connection options are available:

- Wi-Fi connection

The Wi-Fi connection is established with a Wi-Fi-enabled device, e.g. to the customer's mobile phone or tablet PC.

- multimedia system as a Wi-Fi hotspot

Using this function, a tablet PC or notebook for example can be connected.

To establish a connection, you can use the following methods:

- WPS PIN

The connection to a secure Wi-Fi network is made via a PIN.

- WPS PBC

The connection to a secure Wi-Fi network is made by pressing a button (push button).

- security key

The connection to a secure Wi-Fi network is made via a security key.

Setting up Wi-Fi

Requirement:

the device to be connected supports one of the three means of connection described.

Multimedia system:

  System **»** Connectivity

Activating/deactivating Wi-Fi

- ▶ Activate or deactivate Wi-Fi.

If Wi-Fi is deactivated , communication via Wi-Fi to all devices is interrupted. This also means that a connection to the HERMES communication module cannot be established. Functions such as dynamic route guidance with Live Traffic Information are then unavailable.

Connecting the multimedia system with a device via Wi-Fi

This function is available if a HERMES communication module is not installed.

The type of connection established must be selected on the multimedia system and on the device to be connected.

- ❗ The connection procedure may differ depending on the device. Follow the instructions that are shown in the display. Additional information (see the manufacturer's operating instructions).

- ▶ Select **Internet Settings**.

- ▶ Select **WLAN-Netzwerke suchen**.

- ▶ **Via WPS PIN:** highlight a Wi-Fi network in the list.

- ▶ Select  **Connect via WPS PIN**.

The multimedia system generates an eight-digit PIN.

- ▶ Enter this PIN on the device to be connected.

- ▶ Confirm the entry.

- ▶ **By pressing a button:** highlight a Wi-Fi network in the list.

- ▶ Select  **Connect via WPS PBC**.



- ▶ Select "Connect using WPS PBC" in the options on the device to be connected.

- ▶ Press the WPS button on the device to be connected.

- ▶ Select **Continue** in the multimedia system.

- ▶ **Using a security key:** highlight a Wi-Fi network in the list.
- ▶ Select  **Connect Using Security Key.**
- ▶ Open the "Tethering" menu on the device to be connected in order to display the security key (see the manufacturer's operating instructions).
- ▶ Enter this security key on the multimedia system.
- ▶ Confirm the entry.
- ⓘ Using a security key as a means of connection supports all devices.

Device has already been connected

- ▶ **To automatically connect:** highlight a Wi-Fi network in the list.
- ▶ Switch  **Connect Automatically** on .
- ▶ **To connect:** highlight a Wi-Fi network in the list.
- ▶ Select  **Connect.**
The connection is established again. These functions are possible when the device has already been connected to the Wi-Fi network.

Setting up a Wi-Fi hotspot

Multimedia system:

 **System** ▶ **Connectivity**

Activating a Wi-Fi hotspot

- ▶ Switch **Fahrzeug-Hotspot für Geräte sichtbar** on .

Configuring the multimedia system as a Wi-Fi hotspot

The type of connection established depends on the device to be connected. The function must be supported by the multimedia system and by the device to be connected. The type of connection established must be selected on the multimedia system and on the device to be connected.

- ▶ Select **Hotspot Configuration.**
- ▶ **To generate a WPS PIN:** select **Generate WPS PIN.**
- ▶ Enter the PIN shown in the multimedia system display on the device to be connected.
- ▶ Confirm the PIN.

- ▶ **To enter the WPS PIN:** select **Enter WPS PIN.**
- ▶ Enter the PIN which is shown on the external device's display on the multimedia system.
- ▶ Select **OK.**
- ▶ **To connect by pressing a button:** select **Connect via WPS PBC.**
- ▶ Press the push button on the device to be connected.
- ▶ Select **Continue.**
- ▶ **To connect via a security key:** select **Connect Using Security Key.**
- ▶ Select the vehicle from the device to be connected. The vehicle is displayed with the SSID **MB Hotspot XXXXX.**
- ▶ Enter the security key which is shown in the multimedia system display on the device to be connected.
- ▶ Confirm the entry.

Additional configuration menus

In these menus you can modify the Wi-Fi hotspot settings.

- ▶ **To generate a new security key:** select [Generate Security Key](#).
A connection will be established with the newly created security key.
When a new security key is saved, all existing Wi-Fi connections are then disconnected.
- ▶ **To save a security key:** select [Save](#).

Using Near Field Communication (NFC)

Prerequisites

- NFC is activated on the mobile phone (see the manufacturer's operating instructions).
- The mobile phone's screen is switched on and unlocked (see the manufacturer's operating instructions).

NFC enables short-range wireless data transfer.

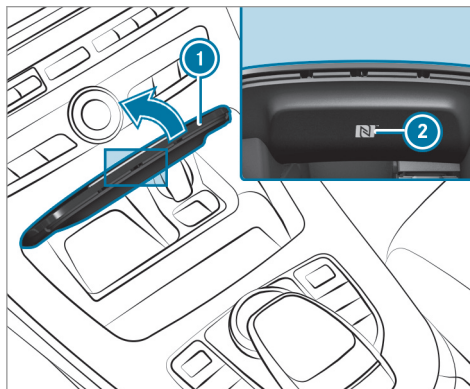

- ▶ Open stowage compartment cover ①.
- ▶ Lightly press marked NFC area ② on the inside of the cover.
The mobile phone is connected to the multimedia system.

Additional functions without having a mobile phone authorized on the multimedia system:

- Transferring a contact or a business card, such as for direct navigation to an entered address.
- Transferring a URL to the enlarged view in the multimedia system.

System language

Notes on the system language

This function allows you to determine the language for the menu displays and the navigation announcements. The selected language affects the characters available for entry. The navigation announcements are not available in all languages. If a language is not available, the navigation announcements will be in English.

Setting the system language

Multimedia system:

▶ System ▶ Language

- ▶ Set the language.

- i** If you are using Arabic map data, the text information can also be shown in Arabic on the navigation map. To do so, select العربية as the language from the language list. Navigation announcements are then also made in Arabic.

Setting the distance unit

Multimedia system:

↳  System ▶ Units

- ▶ Select km or mi.
- ▶ Switch **Additional Speedometer (km/mi)** on for a display in the multifunction display.

Data import and export

Data import/export function

The following functions are possible:

- transferring data from one system or vehicle to another system or vehicle.
- creating a backup copy of your personal data and loading it again.

- protecting your personal data against unwanted export with PIN protection.

You can either use an SD card or a USB storage device as temporary storage.

Importing/exporting data

i NOTE Data loss

- ▶ Do not remove the data storage medium when data is being exported.

Mercedes-Benz is not liable for any loss of data.

Prerequisites

- The vehicle is stationary.
- The ignition is switched on or the vehicle has been started.
- The SD memory card is inserted (→ page 241) or the USB device is connected (→ page 243).

Multimedia system:

↳  System ▶ System Backup

- ▶ Select **Import Data** or **Export Data**.

Importing

- ▶ Select a data storage medium. A prompt appears asking whether you really wish to overwrite the current data. If data originates from another vehicle, this is recognized when the data is read.

The multimedia system is restarted once the data has been imported.

- i** Current vehicle settings can be edited after the import.

Exporting

If PIN protection is activated, your PIN is requested.

- ▶ Enter your four-digit PIN.
- ▶ Select a data storage medium. The data is exported. The data export may take several minutes.

Activating/deactivating PIN protection for data export

Multimedia system:

↳  System ▶ System Backup

- ▶ **To activate:** switch **PIN Protection** on .

- ▶ Enter your four-digit PIN.
 - ▶ Enter your four-digit PIN again.
PIN protection is activated when both PINs match.
 - ▶ **To deactivate:** switch **PIN Protection** off .
 - ▶ Enter your four-digit PIN.
- ⓘ If you have forgotten your PIN, a Mercedes-Benz service center can deactivate your PIN protection for you.
- ⓘ Alternatively: you can deactivate PIN protection by resetting your personal data.

User profile

Selecting a user profile

Multimedia system:

- ▶  **System** ▶ **Personalization**
 - ▶ Select **Guest Profile** or an individual profile
 -
- ⓘ Some settings from the user profile are only loaded when the vehicle is stationary or when the ignition is switched on.

Creating a user profile

Multimedia system:

- ▶  **System** ▶ **Personalization**
- ▶ **Create Profile**
- ▶ Enter a name.
- ▶ Select .

The user profile saves individual settings, e.g.:

- system settings
- settings in the TV tuner's channel list
- navigation and traffic information

The settings differ depending on the vehicle equipment.

Importing/exporting user profiles

Prerequisites

- There is an Internet connection (→ page 233).
- There is a Mercedes connect me account on <http://www.mercedes.me>.
- The **Personalization** service is activated.

Multimedia system:

- ▶  **System** ▶ **Personalization**
- ▶ **Manual Export/Import**

The function is not available in all countries.

Only individual profiles can be imported or exported.

The individual profiles are always collectively imported or exported.

- ▶ **To import:** select **Import Profiles from Server**.

The message **The profile data import overwrites all existing profile data. Do you want to continue?** appears.

- ▶ Select **Yes**.

User profiles are imported.

- ▶ **To export:** select **Export Profiles to the Server**.

User profiles are exported.

- ⓘ Certain settings such as address book entries or previous destinations from the navigation system are not exported.

User profile options

Multimedia system:

→  System ▶ Personalization
▶ Options

The following functions are available:

- [Rename Profile](#)
- [Delete](#)
- [Reset](#)

▶ Select an option.

 The guest profile cannot be deleted or renamed.

Software update

Information on software updates

The multimedia system provides a message when an update is available.

Depending on the source, you can perform various updates:

Source of the update	Update type
Internet	Navigation maps, system updates
External storage medium, e.g. USB stick	Navigation maps

Performing a software update

Requirement:

An Internet connection is required for updates which are obtained online (→ page 233).

Multimedia system:

→  System ▶ Software Update

Automatic

▶ Activate the automatic software update. Updates are performed.

The current status of the updates is displayed.

The automatic software update is not available in all countries.

Manual

▶ Deactivate the automatic software update.

▶ Select an update from the list and start the update.

Activating the software update

▶ Restart the system.

Reset function

Multimedia system:

→  System ▶ Reset

The multimedia system is reset to the factory settings.

Personal data is deleted, for example:

- station presets
- connected mobile phones

▶ Select **Yes**.

A prompt appears asking whether you wish to reset.

No is selected: the process is canceled.

- ▶ Select **Yes**.
The multimedia system is reset to factory settings and restarted.



Navigation

Operating the navigation

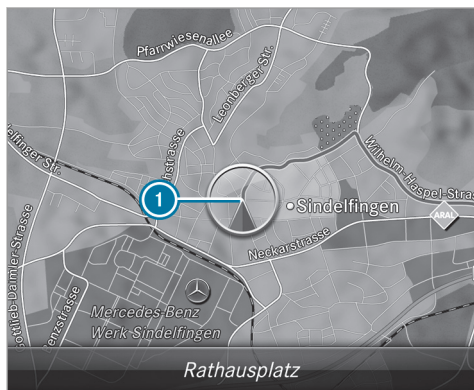

Multimedia system:

Navigation



- ▶ Alternatively: press the **NAVI** button.
The map appears and shows current vehicle position .
-  If a climate control setting is changed, a climate bar appears briefly.

Entering a destination



- ▶ Select  **Destination**.
- ▶ Select one of the options.
 - Enter **Enter Destination**:
 - Search function for addresses or points of interest
 - Enter points of interest
 - Enter previous destination
 - Enter contacts
 - Enter geo-coordinates
- ▶ Alternatively with the Voice Control System: press the  button.
The Voice Control System starts.
- ▶ Say a navigation command, e.g. "navigate to address (point of interest or contact)" or "refuel nearby".

Calculating a route

The destination is entered.

- ▶ **There are no routes**: select **Start Route Guidance**.
- ▶ If **Alternative Route** is activated, select an alternative route.
- ▶ **There is already a route**: select **Start New Route Guidance** or **Set as Next Intermediate Destination**.
- ▶ Alternatively with the Voice Control System: press the  button.
- ▶ Say a navigation command, e.g. "start route guidance".



Selecting route settings

- ▶ Select  **Route**.
- ▶ **To select a route type**: select  **Route Settings**.
- ▶ Select a route type, e.g. **Eco Route**.
- ▶ **Dynamic Traffic Route** or **Query Before Changing Dynamic Route**: activate or deactivate .

- ▶ **To select route options:** select **Avoid Options**.
- ▶ Select the avoid or use option.
- ▶ **To select an alternative route:** select **Alternative Route**.
- ▶ Select an alternative route.

Route guidance

The road and traffic rules and regulations always have priority over multimedia system driving recommendations. Driving recommendations are navigation announcements, route guidance displays and lane recommendations.

- ▶ **To switch on useful functions:** select  **Options**.
- ▶ Switch on **Gas on Reserve** . When the reserve fuel level is reached, you can start the gas station search.
- ▶ **To cancel/resume route guidance:** select  **Destination**.
- ▶ Select **Cancel Route Guidance** or **Continue Route Guidance**.

- ▶ Alternatively with the Voice Control System: press the  button.
- ▶ Say a navigation command, e.g. "cancel route guidance".

Important map functions

- ▶ When the map is displayed, press on the touchpad or controller.
- ▶ The map cross-control appears.

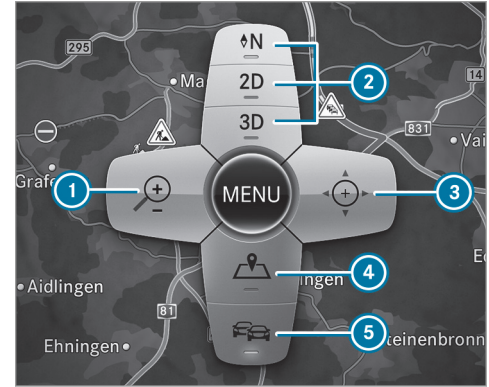

- ① Changes the map scale
 - ② Selects the map orientation and map view
 - ③ Moves the map
 - ④ Calls up the navigation map
 - ⑤ Calls up the traffic map
- ▶ Alternatively with the Voice Control System: press the  button.

- ▶ Say a navigation command, e.g. "traffic map on" or "navigation map on".

Route guidance with traffic reports

Traffic reports are received via Live Traffic Information.

- ▶ Activate the desired route type.
 - ▶ **To display traffic reports in the navigation map or traffic map:** select  **Options**.
 - ▶ Select **Map Content**.
 - ▶ **Traffic Incidents, Free Flow and Traffic Delays:** switch on .
- Traffic reports are displayed as symbols, color lines or text.
- Traffic incidents, e.g. roadworks or accidents
 - Local area reports, e.g. fog
 - Warning messages, e.g. motorists driving against the traffic flow or unsafe accident sites, are highlighted when approaching and depending on the setting are audibly announced

- Traffic flow information, e.g. traffic jam or free flow
- Traffic delays (displayed in the traffic map)

Traffic reports are displayed in the navigation map for the current route. The traffic map also contains traffic reports from outside of the route.



Telephone

Telephony

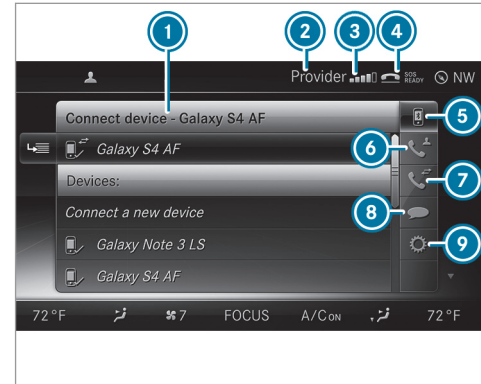
Telephone menu overview



- 1 Bluetooth® device name of the currently connected mobile phone
- 2 Mobile phone network provider
- 3 Signal strength of the mobile phone network

- ④  (telephone ready) or  (call active)
- ⑤ To connect the device (→ page 222)
- ⑥ Contacts (→ page 224)
- ⑦ Call list (→ page 226)
- ⑧ Text messages (→ page 227)
- ⑨ Settings

The Bluetooth® interface is available to you for telephony. In the operating mode the mobile phone is directly connected to the multimedia system.

Symbols ① to ④ are not shown until after a mobile phone has been connected to the multimedia system. The symbols depend on your mobile phone and your mobile phone network provider.

If the mobile phone connected supports the MAP Bluetooth® profile (Message Access Profile), the  Text Message menu item is available.

Notes on telephony

⚠ WARNING Risk of distraction from operating integrated communication equipment while the vehicle is in motion

If you operate communication equipment integrated in the vehicle when driving, you will be distracted from the traffic situation. This could also cause you to lose control of the vehicle.

- ▶ Only operate this equipment when the traffic situation permits.
- ▶ If you cannot be sure of this, stop the vehicle whilst paying attention to road and traffic conditions and operate the equipment with the vehicle stationary.

⚠ WARNING Risk of distraction from operating mobile communication equipment while the vehicle is in motion

If you operate mobile communication equipment when driving, you will be distracted from the traffic situation. This could also cause you to lose control of the vehicle.

Only operate this equipment when the vehicle is stationary.

You must observe the legal requirements for the country in which you are currently driving when operating mobile communication equipment in the vehicle.

Telephony is possible via the Bluetooth® interface.

Bluetooth® profile of the mobile phone	Function
PBAP (Phone Book Access Profile)	Contacts are automatically displayed in the multimedia system
MAP (Message Access Profile)	Message functions can be used

When connecting, the multimedia system always searches for the last connected mobile phone.

You can obtain additional information from a Mercedes-Benz service center or at: <http://www.mercedes-benz.com/connect>

The following situations can lead to the call being disconnected while the vehicle is in motion:

- there is insufficient network coverage in the area
- you move from one GSM or UMTS transmitter/receiver area (cell) into another and no communication channels are free
- the SIM card used is not compatible with the network available
- a mobile phone with "Twincard" is logged into the network with the second SIM card at the same time

Connecting a mobile phone (authorizing)

Prerequisites

Bluetooth® is activated on the mobile phone (see the manufacturer's operating instructions).

Bluetooth® is activated on the multimedia system (→ page 211).

Multimedia system:

➤ Phone ➤  Connect Device - No Device Connected

Searching for a mobile phone

- Select **Connect New Device**.
- Select **Start Search**.
The available mobile phones are displayed. If a new mobile phone is found, it is indicated by the  symbol.

Connecting a mobile phone (authorization using Secure Simple Pairing)

- Select the mobile phone.
A code is displayed in the multimedia system and on the mobile phone.
- **If the codes match:** select **Yes** on the multimedia system.
Confirm the code on the mobile phone.
- **If the codes are different:** select **No** on the multimedia system.
The process is canceled.

Connecting a mobile phone (authorization by entering a passkey)

- Select the Bluetooth® name of the mobile phone.
 - Choose a one to sixteen-digit number combination as a passkey.
 - **Multimedia system:** enter the passkey and select **OK**.
 - **Mobile phone:** enter the passkey again and confirm.
- Up to 15 mobile phones can be authorized on the multimedia system.

All telephones are automatically reconnected.

Disconnecting a mobile phone (de-authorizing)

Multimedia system:

➤ Phone ➤  Connect Device - Mobile phone

- Select the mobile phone from the device list.
- Select .
- Select **Deauthorize**.

- ▶ Select **Yes**.

Switching mobile phones

Requirement

The mobile phones are connected (authorized)
(→ page 222).

Multimedia system:

↳ Phone ▶  Connect Device -
Mobile phone

- ▶ Select the mobile phone from the device list.
- ⓘ Only one mobile phone can be connected at any one time. The connected mobile phone is displayed at the top of the list.

Setting the reception and transmission volume

Requirement:

Mobile phone is connected (authorized)
(→ page 222).

Multimedia system:

↳ Phone ▶  Connect Device -
Mobile phone

This function ensures optimal language quality.

- ▶ Highlight the mobile phone in the device list.
- ▶ Select .
- ▶ Select **Reception Volume** or **Transmission Volume**.
- ▶ Set the volume.

Additional information on the recommended reception and transmission volume: <http://www.mercedes-benz.com/connect>

Adjusting the call and ringtone volume

Multimedia system:

↳ System ▶ Audio

- ▶ Select **Speech Volume** or **Ringtone Volume**.
- ▶ Set the volume.

Calls

Using the telephone

Multimedia system:

↳ Phone ▶  Contacts

Making a call

- ▶ Enter a number.

- ▶ Select **Dial Number**.
The call is made.

Accepting a call

- ▶ Select **Accept**.

Rejecting a call

- ▶ Select **Reject**.

Ending a call

- ▶ Select .

Activating functions during a call

- ▶ To show all functions, navigate down.

The following functions are available during a call:

- Ending a call
- Making another call
- Showing the keyboard
- Switching the microphone on/off
- Switching on private mode (an active call in hands-free mode is transferred over to the telephone)

Conducting calls with several participants

Requirement:

There is an active call (→ page 223).

Switching between calls

- ▶ Select call ●.
- The selected call is active. The other call is on hold.

Activating or ending a call on hold

- ▶ Select [Continue Call](#) or [End Call](#).

Conducting a conference call

- ▶ Select [Create Conference Call](#) in the telephone menu.
- The new participant is included in the conference call.

Ending an active call

- ▶ Select .
- i On some mobile phones, the call on hold is activated as soon as the active call is ended.

Incoming call during an existing call (call waiting)

Requirement:

There is an active call (→ page 223).

If you receive a call while already in a call, a message is displayed. An acoustic signal also sounds.

- ▶ Select [Accept](#).
- The incoming call is active. The previous call is on hold.
- ▶ Select [Reject](#).
- i This function and behavior depends on your mobile phone network provider and the mobile phone (see the manufacturer's operating instructions).

Contacts

Information about the contacts menu

The contacts menu contains all contacts from existing data sources, e.g. mobile phone or memory card.

It is possible to store up to 6,000 contacts:

- 3,000 entries are for permanently saved contacts.
- 3,000 for contacts loaded from the mobile phone.

From the contacts menu, you can perform the following actions:

- Telephone operation (→ page 226)
- Navigation
- Writing messages (→ page 226)

If a mobile phone is connected to the multimedia system (→ page 222) and automatic retrieval (→ page 224) is activated, the mobile phone's contacts are displayed in the address book.

Downloading mobile phone contacts

Multimedia system:

 Phone ▶  Options ▶ Call Up
Contacts Automatically

Automatic

- ▶ Allow automatic download .

Manual

- ▶ Deactivate automatic download .
- ▶ Select [Import Contacts](#).

Calling up contacts

Multimedia system:

↳ [Phone](#) ▶ [Contacts](#)

The following options are available for searching for contacts:

- search by name
- search by initials
- search by phone number
- ▶ Enter characters into the search field. A selection of possible contacts appears. Entering more characters into the search field narrows down the number of possible selections.
- ▶ Select the contact.

A contact can contain the following details:

- phone numbers
- e-mail addresses
- navigation addresses

- geo-coordinates

Editing the format of a contact's name

Multimedia system:

↳ [Phone](#) ▶ [Settings](#) ▶ [Contacts](#)
▶ [Name Format](#)



The following options are available:

- [Last Name, First Name](#)
- [Last Name First Name](#)
- [First Name Last Name](#)

- ▶ Select an option.

Importing contacts into the contacts menu

Via [Options](#), you can import contacts into the telephone book as electronic business cards using a memory card, USB or Bluetooth®.

Source	Prerequisites
 Memory card	The SD memory card is inserted.
 USB device	The USB device is inserted into the USB port.
 Bluetooth® connection	If the sending of vCards is supported via Bluetooth®, vCards can be received on mobile phones or netbooks, for example. Bluetooth® is activated in the multimedia system and on the respective device (see the manufacturer's operating instructions).

Saving a mobile phone contact

Multimedia system:

→ Phone →  Contacts

▶ Call up a mobile phone contact  (→ page 225).

▶ Select .

▶ Select **Save**.

The contact saved in the multimedia system is identified by the  symbol.

Calling a contact

Multimedia system:

→ Phone →  Contacts

▶ Enter characters into the search field.

▶ Select the contact.

▶ Select a telephone number.
The number is dialed.

Additional options in the contacts menu

Multimedia system:

→ Phone →  Contacts

▶ Select .

The following functions are available:

- **Contact Details**
- **Save to Vehicle**
- **Delete Contact**

Within contact details

▶ Select .

The following functions are available:

- Calling a contact
- Sending a text message
- Saving a contact as a global favorite

Deleting a name

Multimedia system:

→ Phone →  Contacts

You can delete contacts that are not automatically downloaded.

▶ Search for a contact.

▶ Select the contact.

▶ Select .

▶ Select **Delete Contact**.

▶ Select **Yes**.

Call list**Call list overview**

If your mobile phone supports the PBAP Bluetooth® profile, the call lists from the mobile phone are displayed in the multimedia system. When connecting the mobile phone, you may have to confirm the connection for the PBAP Bluetooth® profile.

If your mobile phone does not support the PBAP Bluetooth® profile, the multimedia system generates its own call lists. These are not the same as the call lists in your mobile phone.

If the contact for an incoming call has yet to be saved in the multimedia system, you can use the call list to save the telephone number.

Making a call from the call list

Multimedia system:

→ Phone →  Call List - Mobile phone

▶ Select an entry.

▶ Make the call.

Options in the call list

Multimedia system:

→ Phone → ☎ Call List - Mobile phone

▶ Highlight the entry.

▶ Select .

The following functions are available:

- [Send Text Message](#)
- [Open Contact](#)

Deleting the call list

Call lists which are generated and managed by the multimedia system can be deleted in the multimedia system.

Multimedia system:

→ Phone → ☎ Call List - Mobile phone

▶ Delete Call List

▶ Select [Yes](#).

Text messages

Notes on the text message functions

If the connected mobile phone supports the MAP Bluetooth® profile, the text message func-

tions can be used on the multimedia system. You can obtain additional information about the settings and supported functions of Bluetooth®-capable mobile phones from a Mercedes-Benz service center or on the Internet at <http://www.mercedes-benz.com/connect>.

Some mobile phones require additional settings after being connected to the multimedia system (see manufacturer's operating instructions).

New messages are identified by the  symbol in the multimedia system's display and an audible signal.

- The multimedia system displays the 100 newest text messages.
- The  symbol is displayed when the mobile phone's message memory is full.

Configuring the text messages displayed

Multimedia system:

→ Phone → ⚙ Settings → Text Message

▶ Highlight the text message.

▶ Select .

A menu with the following options is shown:

- [All Messages](#)
- [New and Unread Messages](#)
- [New Messages](#)
- [Off](#) (The text messages are not displayed automatically.)

▶ Select an option.

Reading text messages

Multimedia system:

→ Phone → 📧 Text Message

Reading a text message

▶ Select a text message.
The message text is displayed.

Using the read-aloud function

▶ Select a text message.

▶ Select .

▶ Select .

The text message is read aloud.

Composing a text message

Multimedia system:

Phone » Text Message

Dictating text

- ▶ Select **Press to Dictate**.
The app for the dictation function is loaded.
If there was no prior Internet connection, a connection is now established.
- ▶ To start the dictation function: press the controller or touchpad.
- ▶ Say your message.
The dictation ends automatically after you have finished speaking.
After the voice message has been processed, it is shown as text.

Editing text

- ▶ Select the word.
- ▶ To call up the correction menu: press the controller or touchpad.
The following functions are available:
 - adjusting the capitalization of words (if supported by the character set)

- expanding the choice of words
- deleting the selection
- recording a new dictation

- ▶ To exit the menu: select **Done**.

Replying to a text message

Multimedia system:

Phone » Text Message

- ▶ Select a text message.
- ▶ Select .
- ▶ Select **Reply**.

Calling a text message sender

Multimedia system:

Phone » Text Message

- ▶ Select a text message.
- ▶ Select .
- ▶ Select **Call Sender**.

Deleting text messages

Multimedia system:

Phone » Text Message

- ▶ Select .

- ▶ Select **Delete**.

Apple CarPlay®

Overview of Apple CarPlay®

iPhone® functions can be used via the multimedia system using Apple CarPlay®. It is operated using the controller or the Siri® voice-operated control system.

Only one mobile phone at a time can be connected via Apple CarPlay® to the multimedia system.

The availability of Apple CarPlay® may vary according to the country.

Connecting an iPhone® via Apple CarPlay®

Prerequisites

- Apple CarPlay® can be used with Apple operating system version iOS 8.3 or above.
- The full range of functions for Apple CarPlay® is only possible with an Internet connection.

Multimedia system:

↳ Connect ▶▶ Apple CarPlay

Activating automatic start

- ▶ Select **Start Automatically** .

Starting automatically

- ▶ Connect your iPhone® to the USB port  on the multimedia system using a suitable cable (→ page 243).

Starting manually

- ▶ Select the iPhone® in the device list.

Exiting Apple CarPlay®

- ▶ Select  in Apple CarPlay®.

Calling up Apple CarPlay® tone settings

Multimedia system:

↳ Connect ▶▶ Apple CarPlay

▶▶  Sound

- ▶ Select the tone menu (→ page 258).

Ending Apple CarPlay®

Multimedia system:

↳ Connect ▶▶ Apple CarPlay

- ▶ Select **Disconnect**.
The connection is ended.
The mobile phone continues to be supplied with electricity.
- or
- ▶ Disconnect the connecting cable between the mobile phone and multimedia system.

Android Auto®

Android Auto® overview

Mobile phone functions can be used with Android Auto® using the Android® operating system on the multimedia system. It is operated using the controller or the voice-operated control system.

Only one mobile phone at a time can be connected via Android Auto® to the multimedia system.

The availability of Android Auto® and Android Auto® apps may vary according to the country.

Connecting a mobile phone via Android Auto®

Prerequisites

- the first activation of Android Auto® on the multimedia system must be carried out when the vehicle is stationary for safety reasons.
- the mobile phone supports Android Auto® from Android® 5.0.
- the Android Auto® app is installed on the mobile phone.
- in order to use the telephone functions, a mobile phone must be connected to the multimedia system via Bluetooth® (→ page 222).
If there was no prior Internet connection, this is established with the use of the mobile phone with Android Auto®.
- The full range of functions for Android Auto® is only possible with an Internet connection.

Multimedia system:

➔ [Connect](#) ➔ [Android Auto](#)

Activating automatic start

- ▶ Select [Start Automatically](#).

Starting automatically

- ▶ Connect your mobile phone to the  USB port on the multimedia system using a suitable cable (→ page 243).

Starting manually

- ▶ Select the mobile phone from the device list.

Exiting Android Auto®

- ▶ Press the  button.

Calling up the Android Auto® tone settings

Multimedia system:

➔ [Connect](#) ➔ [Android Auto](#) ➔  [Sound](#)

- ▶ Select the tone menu (→ page 258).

Exiting Android Auto®

Multimedia system:

➔ [Connect](#) ➔ [Android Auto](#)

- ▶ Select [Disconnect](#).
The connection is ended.

The mobile phone continues to be supplied with electricity.

- ▶ Disconnect the connecting cable between the mobile phone and multimedia system.

Mercedes-Benz mbrace®

Making a call via the overhead control panel

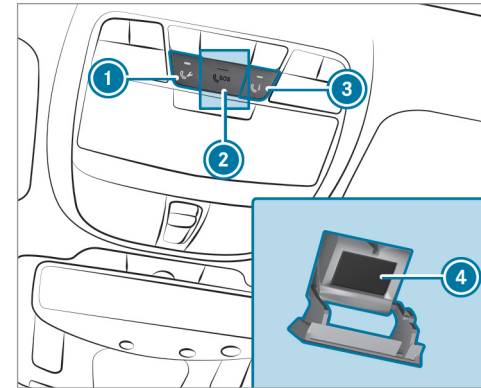

- ① Roadside Assistance call
- ② SOS button cover
- ③ MB Info call
- ④ SOS button

- ▶ **To make a Roadside Assistance call:** press button ①.
This initiates a call to the Mercedes-Benz Customer Assistance Center.
- ▶ **To make an emergency call:** press SOS button cover ② briefly to open.
- ▶ Press and hold SOS button ④ for at least one second.
This initiates a call to the Mercedes-Benz Customer Assistance Center.
- ▶ **To make an MB Info call:** press button ③.
This initiates a call to the Mercedes-Benz Customer Assistance Center.

An emergency call can be initiated even if a Roadside Assistance or MB Info call is active. This has priority over all other active calls.

Calls via the overhead control panel are only possible with an available mobile phone network.

Additional information on Mercedes-Benz mbrace® and other services can be found at: <http://www.mbusa.com>

Information on the emergency call system

⚠ WARNING Risk of accident and injury despite pressing the SOS button

Even if you press the SOS button in an emergency, remaining in the vehicle may be dangerous for the following reasons:

- you see smoke inside or outside of the vehicle, e.g. if there is a fire after an accident
 - the vehicle is on a dangerous section of road
 - the vehicle is not visible or cannot easily be seen by other road users, particularly when dark or in poor visibility conditions
- ▶ Leave the vehicle immediately in this or similar situations as soon as it is safe to do so.
 - ▶ Move to a safe location along with other vehicle occupants.
 - ▶ In such situations, secure the vehicle in accordance with national regulations, e.g. with a warning triangle.

Automatic emergency call

The emergency call is initiated:

- when an airbag is deployed
- when seat belt tensioners are triggered

You can end an automatically initiated emergency call yourself after 60 seconds.

Manual emergency call

An emergency call can be initiated manually via the SOS button in the overhead control panel (→ page 230).

If you leave the vehicle immediately after pressing the SOS button, you do not know if Mercedes-Benz mbrace® has successfully made the emergency call.

Initiated emergency call

A voice connection between the Customer Assistance Center and the vehicle occupants is established:

- if the vehicle occupants are responsive, the Mercedes-Benz Customer Assistance Center asks for more detailed information on the emergency.

- if no vehicle occupant answers, an ambulance is sent to the vehicle immediately.

Transmitted data

During the voice connection to the Customer Assistance Center, the following data is transferred:

- current vehicle location
- vehicle identification number

Emergency call not possible

- if the mobile phone network is unavailable, Mercedes-Benz mbrace® is not able to make an emergency call.

A message to this effect is shown in the multifunction steering wheel.

The indicator lamp flashes continuously.

In this case, seek assistance by other means.

Information on the MB Info call

An Info call to the Mercedes-Benz Customer Assistance Center has been initiated via the overhead control panel (→ page 230).

You can find information on the following topics:

- Activating Mercedes-Benz mbrace®
- Operating the vehicle
- Nearest Mercedes-Benz service center
- Other products and services from Mercedes-Benz

Data is transmitted during the connection to the Mercedes-Benz Customer Assistance Center .

Information on the Roadside Assistance call

A Roadside Assistance call to the Mercedes-Benz Customer Assistance Center has been initiated via the overhead control panel:

- The problem with the vehicle is analyzed using remote diagnosis.

Additional information is available at <http://www.mbusa.com>.

- A qualified Mercedes-Benz technician carries out repairs on site and/or the vehicle will be towed to the nearest Mercedes-Benz service center.

You may be charged for these services.

Data is transmitted during the connection to the Mercedes-Benz Customer Assistance Center .

Transferred data during a service call

In certain countries you must confirm the data transfer.

Data transferred includes the following:

Service call	Transmitted data
MB Info call Roadside Assistance call	<ul style="list-style-type: none"> • current vehicle location • vehicle identification number • the service code • selected data about the status of the vehicle

Online and Internet functions

Internet connection

Internet connection restrictions

⚠ WARNING Risk of distraction from information systems and communications equipment

If you operate information and communications equipment integrated in the vehicle when driving, you will be distracted from the traffic situation. This could also cause you to lose control of the vehicle.

- ▶ Only operate this equipment when the traffic situation permits.
- ▶ If you cannot be sure of this, stop the vehicle whilst paying attention to road and traffic conditions and operate the equipment with the vehicle stationary.

You must observe the legal requirements for the country in which you are currently driving when operating the multimedia system.

USA: to use Mercedes-Benz Apps and Internet access, mbrace must be activated and operational. Furthermore, mbrace must be activated for Mercedes-Benz Apps and Internet access.

Canada: the multimedia system must be connected to a mobile phone via Bluetooth® or to an external device acting as a Wi-Fi hotspot. Furthermore, you need a valid mobile service contract with a data option, which is used to calculate the associated connection costs.

The Internet connection via Bluetooth® may be restricted or not function if:

- the mobile phone is switched off
- the mobile phone network coverage is insufficient
- the use of mobile data is deactivated on the mobile phone
- the Bluetooth® function is switched off on the multimedia system and the desired phone is to be connected via Bluetooth®
- the Bluetooth® function is switched off on the mobile phone and the phone is to be connected via Bluetooth®

- neither the mobile phone network nor the mobile phone allow simultaneous use of a phone and an Internet connection
- the mobile phone has not been enabled for Internet access via Bluetooth®

The Internet connection via a Wi-Fi hotspot may be restricted or not function if:

- the mobile phone is switched off
- the use of mobile data is deactivated on the mobile phone
- the Wi-Fi function on the multimedia system is switched off and an external device is to be connected as a Wi-Fi hotspot
- the Wi-Fi function on the external device is switched off and the external device is to be connected as a Wi-Fi hotspot
- Internet access via Wi-Fi is deactivated on the external device



The Internet functions can only be used to a limited degree while driving.

Setting up an Internet connection via a Wi-Fi hotspot

Prerequisites

- Activate the Wi-Fi function on the multimedia system (→ page 212).
- Activate the Wi-Fi function on the external device (see the manufacturer's operating instructions).
- Activate Internet access via Wi-Fi (see the manufacturer's operating instructions).

Multimedia system:

→  System >>  Connectivity
 >> Internet Settings >> WLAN-Netzwerke suchen

- ▶ Select a Wi-Fi hotspot.
A prompt appears.
- ▶ Select **Yes**.

Setting up an Internet connection via Bluetooth®

Prerequisites

- connect a mobile phone to the multimedia system via Bluetooth® (→ page 222).

- if you use the telephone module for Internet functions, you require a SIM card in the telephone module or a Bluetooth®-capable SAP mobile phone.

To connect via Bluetooth®, the mobile phone must support one of the following Bluetooth® profiles:

- DUN (Dial-Up Networking)
- PAN (Personal Area Network)

You can obtain more detailed information from a Mercedes-Benz service center or at: <http://www.mercedes-benz.com/connect>.

Multimedia system:

→  System >>  Connectivity
 >> Internet Settings

- ▶ Highlight a mobile phone.
- ▶ Select .
- ▶ Select **Change Configuration**.
- ▶ Switch **Automatic Configuration** on .
If the mobile phone supports the Bluetooth® PAN profile, Internet access is set up. You can use the Internet functions. If the mobile

phone does not support the named Bluetooth® profile, predefined or manual access data must be set.

Selecting the predefined access data of the mobile phone network provider

- ▶ Select **Configure Settings Using COMAND**.
- ▶ Select **Predefined Settings**.
A list of countries appears.
- ▶ Select the country of your mobile phone network provider.
The list of available providers appears.
- ▶ Select your mobile phone network provider.
An overview of the provider settings appears.
- ▶ Select **Confirm Settings**.

Manually setting the access data of the mobile phone network provider







- ▶ Select **Configure Settings Using COMAND**.
- ▶ Select **Manual Settings**.
An overview of the provider settings appears.
- ▶ Set access data.
- ▶ Select **Confirm Settings**.

-  Set the access data in accordance with your data package. Otherwise, additional costs may occur. You can contact your mobile phone network provider to obtain the precise access data.

Editing the access data

Multimedia system:





  System   Connectivity
 Internet Settings

-  Highlight a mobile phone.
-  Select .
-  Select [Change Configuration](#).
-  Select [Configure Settings Using COMAND](#).
-  Select [Predefined Settings](#) or [Manual Settings](#).
The provider settings are displayed.
-  Set access data.

Canceling Internet access permission for a mobile phone

Multimedia system:





  System   Connectivity
 Internet Settings

-  Highlight a mobile phone.
-  Select .
-  Select [Delete Configuration](#).
-  Select [Yes](#).

Displaying mobile phone details

Multimedia system:

  System   Connectivity
 Internet Settings





-  Highlight a mobile phone.
-  Select .
-  Select [Details](#).

Setting up a permanent Internet connection

Multimedia system:

  System   Connectivity
 Internet Settings





-  Highlight a mobile phone.

-  Select .
-  Select [Permanent Internet Connection](#).
-  Activate or deactivate the function.

Setting automatic disconnection of the Internet connection

Multimedia system:

  System   Connectivity
 Internet Settings

-  Highlight a mobile phone.
-  Select .
-  Select [Disconnect When Inactive](#).
-  Select [5 Minutes](#), [10 Minutes](#), [20 Minutes](#) or [Never](#).

Establishing an Internet connection

Multimedia system:

 [Connect](#)

-  For example, select [Browser](#).

Connection status

Overview of connection status



- 1 Display of existing connection and reception field strength of the mobile phone network

Displaying the connection status

Multimedia system:

→ System → Connectivity

- ▶ Select **Internet Status**.
- i The data volume used is displayed. The exact values can be requested from your mobile phone network provider.

Disconnecting

- ▶ Select **Disconnect**.

Mercedes-Benz Apps

Calling up Mercedes-Benz Apps

Requirements

- You are registered for using Mercedes-Benz Apps.
- You have confirmed the terms and conditions.

Multimedia system:

→ **Connect** → **MB Apps**

- ▶ Select App.

Further Mercedes-Benz Apps and information can be found under:

<http://s.mercedes-benz.com/apps/>

- i The available features are country-dependent.
- i License fees may be applicable.

Using Mercedes-Benz Apps voice control

Prerequisites:

- Register to use Mercedes-Benz Apps.
- Confirm the general terms and conditions.

You can use the following Apps via the voice control system:

- Weather
- Google® Local Search
- TuneIn Radio

- ▶ Call up the Mercedes-Benz App (→ page 236).

The basic menu of the App is displayed.

- ▶ To use voice control: select **Language**.
- ▶ Voice a question or a demand.

- i Voice control is not available in all countries.

Web browser

Calling up a website

Multimedia system:

➤ Connect ➤ Browser ➤ **URL** Enter URL

▶ Enter a web address.

▶ **To finish an entry and call up a website:**

select **ok** .

ⓘ Websites cannot be shown while the vehicle is in motion.

Overview of the web browser

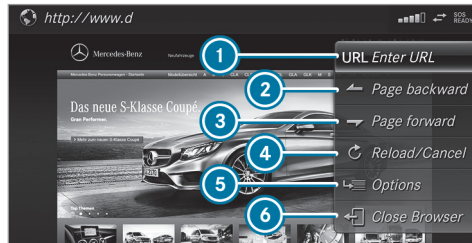

- ① URL entry
- ② Web page, back

- ③ Web page, forwards
- ④ Refreshes/stops
- ⑤ Options
- ⑥ Closes the browser

Calling up the web browser options

Multimedia system:

➤ Connect ➤ Browser ➤ **Options**

The following functions are available:

- Bookmarks
- Zoom
- Font Size
- Browser Settings
- Delete Browser Data

- ▶ Select an option.
- ▶ Change the settings.

Calling up the web browser settings

Multimedia system:

➤ Connect ➤ Browser ➤ **Options**
➤ Browser Settings

The following functions are available:

- Block Pop-Ups
- Activate Javascript
- Allow Cookies
- Smartscroll

▶ Activate or deactivate the function.

Deleting Internet history

Multimedia system:

➤ Connect ➤ Browser ➤ **Options**
➤ Delete Browser Data

The following functions are available:

- All
- Cache
- Cookies
- Entered URLs
- Form Data

- ▶ Select an option.
- ▶ Select **Yes**.

Setting Internet favorites

Multimedia system:

- ➔ **Connect** ▶ **Browser** ▶  **Options**
- ▶ **Bookmarks**

Selecting favorites

- ▶ Select bookmarks.

Creating favorites

- ▶ Select **Add New Bookmark**.
- ▶ Enter URL and name.
- ▶ Select .

Editing favorites

- ▶ Select bookmarks.
- ▶ Select **Edit**.
- ▶ Enter URL and name.
- ▶ Select .

Deleting favorites

- ▶ Select **Delete**.

- ▶ Select **Yes**.

Closing the browser

Multimedia system:

- ➔ **Connect** ▶ **Browser**

- ▶ Select  **Close Browser**.
- ▶ Select **Yes**.

Internet radio

Calling up the Internet radio

Prerequisites

- There is a Mercedes connect me account on <http://www.mercedes.me>.
- The "Internet radio" service is activated.
- A fast Internet connection for data transmission free of interference (→ page 233).

Multimedia system:

- ➔ **Radio** ▶  **Online Services**

- ▶ Select **Tuneln**.
- The Internet radio display appears. The last station set starts playing.

- ⓘ The connection quality depends on the local mobile phone reception.

Internet radio overview

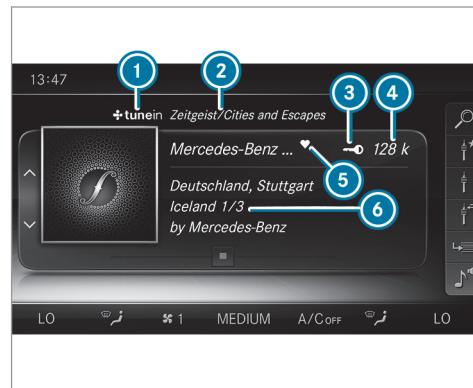

- ① Internet radio provider
- ② Selected category
- ③ Display (if connected to private user account)
- ④ Data rate

- ⑤ Current station is stored as a favorite
- ⑥ Additional information on the current station

Selecting and connecting to Internet radio stations

Multimedia system:

↳ Radio ▶▶ [Internet] Online Services ▶▶ Tuneln
▶▶ [Search] Search

- ▶ Enter the station name using the entry field.
or
- ▶ Select **Browse by Category**.
- ▶ Select a category.
- ▶ Select a station.
The connection is established automatically.
- ⓘ A relatively large volume of data can be transmitted when using Internet radio.

Saving/deleting Internet radio stations as favorites

Multimedia system:

↳ Radio ▶▶ [Internet] Online Services ▶▶ Tuneln

- ▶ Press and hold the touchpad or controller until the heart symbol appears by the station name.
- ▶ Select **Favorites**.
The list of saved favorite stations appears.
- or
- ▶ Create an account for the online provider (Tuneln) and then log in on the multimedia system.
Your favorites are imported onto the multimedia system.

Deleting favorites

- ▶ Select a favorite.
- ▶ Press and hold the touchpad or controller until the heart symbol by the station name disappears.

Setting the Internet radio options

Multimedia system:

↳ Radio ▶▶ [Internet] Online Services ▶▶ Tuneln
▶▶ [Options] Options

The following functions are available:

- **Stream selection:** Selection of the stream quality.
- **Log-in / Log-out:** Logging into and logging out of your Tuneln user account.
- **Terms and Conditions:** Displays the general terms and conditions.
- ▶ Select an option.

Media

Audio mode

Information on audio mode

⚠ WARNING Risk of distraction when handling data storage medium

If you handle a data storage medium while driving, your attention is diverted from the

traffic conditions. This could also cause you to lose control of the vehicle.

- ▶ Only handle a data storage medium when the vehicle is stationary.

Permissible file systems:

- FAT32
- exFAT
- NTFS

Permissible data storage medium:

- SD memory card
- USB storage device

- ① The multimedia system supports a total of up to 50,000 files.

Supported formats:

- MP3
- WMA
- AAC formats

- ① Due to the large variety of available music files regarding encoders, sampling rates and

bit rates, playback cannot always be guaranteed.

- ① Due to the wide range of USB devices available on the market, playback cannot be guaranteed for all brands of USB devices.
- ① Copy-protected music files or DRM encrypted files cannot be played back.
- ① MP3 players must support Media Transfer Protocol (MTP).



Manufactured under license from Dolby Laboratories. Dolby and the double-D symbol are trademarks of Dolby Laboratories.



Gracenote, the Gracenote logo and logotype are either a registered trademark or a trademark of Gracenote, Inc. in the USA and/or other countries.

Notes on copyright

Audio files that you create or reproduce yourself for playback are generally subject to copyright protection. In many countries, reproductions, even for private use, are not permitted without the prior consent of the copyright holder. Make sure that you know about the applicable copyright regulations and that you comply with these.

Activating media mode

Multimedia system:

 Media »  Devices

- ▶ Select the media source.
Playable music files are played back.

Inserting/removing an SD memory card

⚠ DANGER Risk of fatal injury caused by swallowing SD memory cards

SD memory cards are small parts.

They can be swallowed and cause choking.

- ▶ Keep SD memory cards out of the reach of children.

- ▶ Seek medical attention immediately if a SD memory card has been swallowed.

! **NOTE** Damage caused by high temperatures

High temperatures can damage the SD memory card.

- ▶ Remove the SD memory card after use and take it out of the vehicle.

Multimedia system:

 Media »  Devices » Memory Card
Inserting

The multimedia connection unit is located in the stowage compartment under the armrest.

- ▶ Insert the SD memory card into the SD card slot until it engages. The side with the contacts must face downwards.
Playable music files are played back.

Removing

- ▶ Press the SD memory card.
- ▶ Eject the SD memory card.

Overview of the audio mode

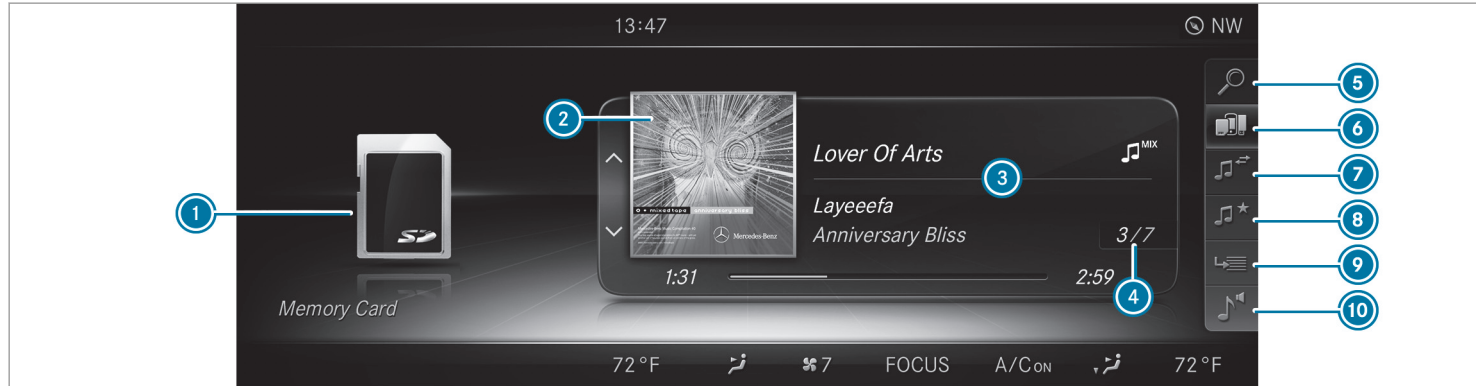

- ① Active data storage medium
- ② Cover
- ③ Artist, title and album
- ④ Track number and number of tracks in the track list

- ⑤ Search
- ⑥ Devices
- ⑦ Online services
- ⑧ Media favorites

- ⑨ Options
- ⑩ Tone settings

Connecting USB devices

NOTE Damage caused by high temperatures

High temperatures can damage USB devices.

- ▶ Remove the USB device after use and take it out of the vehicle.

The multimedia connection unit is found in the stowage compartment under the armrest and has two USB ports. Depending on the vehicle equipment, a further USB port is found in the stowage compartment of the center console at the front.

- ▶ Connect the USB device to the USB port. Playable music files are played back only if the corresponding media display is activated.
- ① Use the USB port identified by  to use Apple CarPlay® and Android Auto®.

Selecting a track

Multimedia system:

- ↳ [Media](#)

Via skip function

- ▶ **To skip backwards or forwards to a track:** navigate up or down.

Via current track lists

- ▶ Select .
- ▶ Select [Current Track List](#).
- ▶ Select a track.

Selecting playback options

Multimedia system:

- ↳ [Media](#) ▶  [Options](#)

Playing back similar tracks

- ▶ Select [Play Similar Tracks](#).
A track list with similar tracks is created and played back.



Play mode

- ▶ Select [Playback Mode](#).

- ▶ Select [Normal Track Sequence](#).
The current track list is played in the order it appears on the data storage medium.
- ▶ Select [Random Mode - Current Playlist](#).
The current track list is played in random order.
- ▶ Select [Random Mode - Current Medium](#).
All tracks on the data storage medium are played in random order.

Pause and playback function

Multimedia system:

- ↳ [Media](#)
- ▶ Press the touchpad or the controller.
- ▶ **To pause playback:** select .
- ▶ **To continue playback:** select .

Fast forward/rewind

- ▶ Slide the controller to the left or right .

Video mode

Activating video mode

Multimedia system:

↳ Media ▶  Devices

- ▶ Select a data storage medium.
- ▶ Playable video files are played back.

 The multimedia system supports MPEG, AVI and MP4 formats. Due to the large variety of available video files regarding encoders, refresh rates and bit rates, playback cannot always be guaranteed.

Overview of video mode

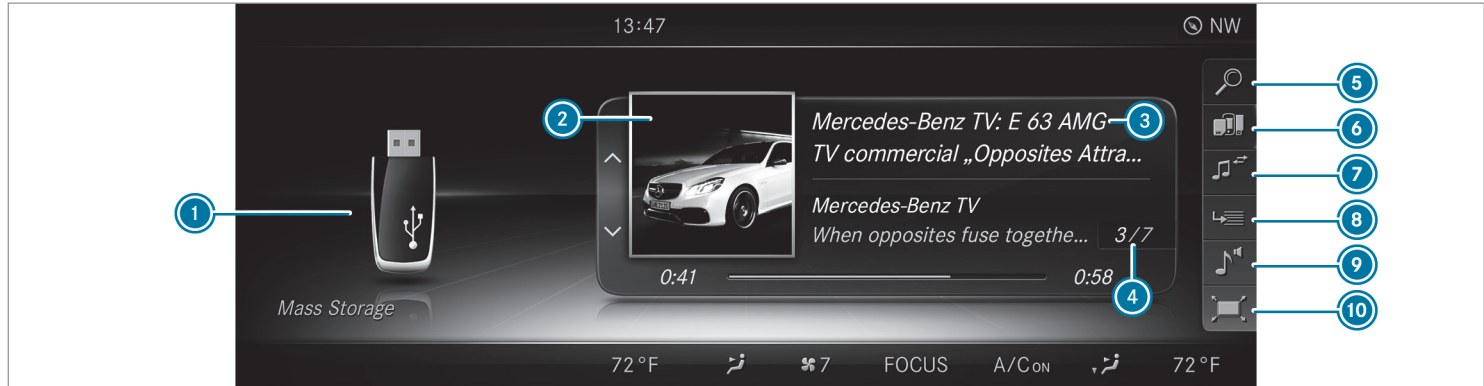

① Active data storage medium

② Cover

③ Title and scene

④ Track number and number of tracks in the track list

⑤ Search

⑥ Devices

⑦ Media list

⑧ Options

⑨ Tone settings

⑩ Full screen

Activating/deactivating full-screen mode

Multimedia system:

→ Media ▶  Devices

- ▶ Select the data storage medium. Playable video files are played back.

- ▶ **To activate full-screen mode:** select  Full Screen.

- ▶ **To deactivate full-screen mode:** press the touchpad or controller.

Changing video settings

Multimedia system:

→ Media ▶  Options ▶ Video Settings

The following picture formats are available:

- Automatic
- 16:9
- 4:3
- Zoom

- ▶ Select the picture format.

Adjusting the brightness manually

- ▶ Select **Brightness**.

- ▶ Adjust the brightness.

Media search**Starting the media search**

Multimedia system:

→ Media ▶  Search

Depending on the connected media sources and files, the following categories are listed:

- Albums
- Artists
- Tracks
- Keyword Search
- Playlists
- Videos
- Folder
- Year
- Genres
- Current Track List
- Music Genres
- Composers

- **Genius Mixes** (Apple® devices)
- **Podcasts** (Apple® devices)
- **iTunes U** (Apple® devices)
- **Audiobooks** (Apple® devices)

- ▶ Select a category.

Media Interface**Information about the Media Interface**

Media Interface is a universal interface for the connection of mobile audio equipment. The multimedia system has two USB ports. The USB ports are located in the stowage compartment under the armrest.

Supported devices

The Media Interface allows you to connect the following data storage media:

- iPod®
- iPhone®
- iPad®
- MP3 player

- USB devices

For details and a list of supported devices, visit our website at <http://www.mercedes-benz-mobile.com/>. Observe the information in the "Media Interface" section.

Switching on Media Interface

Multimedia system:

 [Media](#)   [Devices](#)

- ▶ Connect the data storage medium with the USB port (→ page 243).

- ▶ Select the media device.
Playable music files are played back.

Media Interface overview

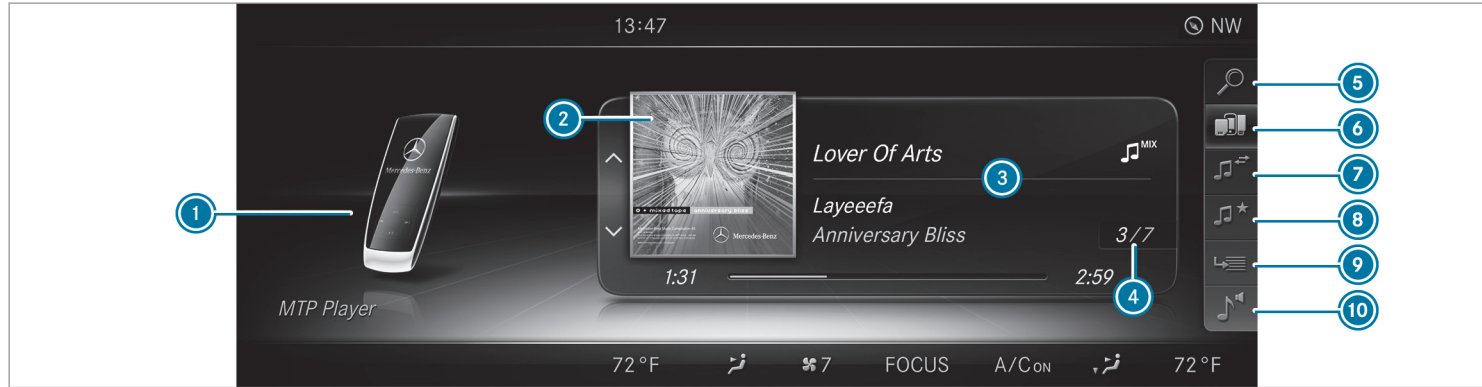

- ① Active data storage medium
- ② Cover
- ③ Artist, track and album
- ④ Track number and number of tracks in the track list

- ⑤ To search
- ⑥ Devices
- ⑦ Media list
- ⑧ Media favorites

- ⑨ Options
- ⑩ Tone settings

Bluetooth® audio

Information about Bluetooth® audio

Before using your Bluetooth® audio equipment with the multimedia system for the first time, you will need to authorize it.

Searching for and authorizing the Bluetooth® audio equipment

Prerequisites

Bluetooth® is activated on the multimedia system (→ page 211).

Check your Bluetooth® audio equipment for the following (see the manufacturer's operating instructions):

- the Bluetooth® audio equipment must support the A2DP and AVRCP Bluetooth® audio profiles.
- the Bluetooth® function must be activated.
- the Bluetooth® audio equipment must be "visible" for other devices.

Multimedia system:

→ Media →  Devices
 → Bluetooth Audio →  Options → Add New Bluetooth Audio Device

- ▶ Select **Start Search**.
The multimedia system searches for Bluetooth® audio equipment within range and adds them to the Bluetooth® device list.
- ▶ Select Bluetooth® audio equipment.
A prompt appears asking if you want to connect the device as audio equipment.
- ▶ Select **Yes**.
Authorization is initiated.

Option 1: Secure Simple Pairing

A code is displayed on the multimedia system and on the mobile phone.

- ▶ Confirm on both devices if the codes are identical.

Option 2: entering the passkey

The input menu for the passkey is displayed.

- ▶ **Multimedia system:** choose a one to sixteen-digit number combination as a passkey.

- ▶ Select OK once all the numbers have been entered.
- ▶ **Mobile phone:** enter the same passkey and confirm your entry.
After successful authorization, the Bluetooth® audio equipment is connected and starts playback.

Establishing a connection from the Bluetooth® audio equipment

The Bluetooth® device name of the multimedia system is **MB BLUETOOTH XXXX**.

- ▶ Select **Search from Device**.
- ▶ Initiate authorization on your Bluetooth® audio equipment (see the manufacturer's operating instructions).
After successful authorization, the Bluetooth® audio equipment is connected and starts playback.

With some Bluetooth® audio equipment, playback must be initially started on the device itself so that the multimedia system can play the audio files.

- ① Device-specific information on authorizing and connecting Bluetooth®-capable mobile phones can be obtained at

<http://www.mercedes-benz.com/connect> or from a Mercedes-Benz service center.

Activating Bluetooth® Audio

Multimedia system:

↳ Media ▶  Devices

- ▶ Select **Bluetooth Audio**.
The multimedia system activates the connected Bluetooth® audio equipment.

Bluetooth® Audio overview

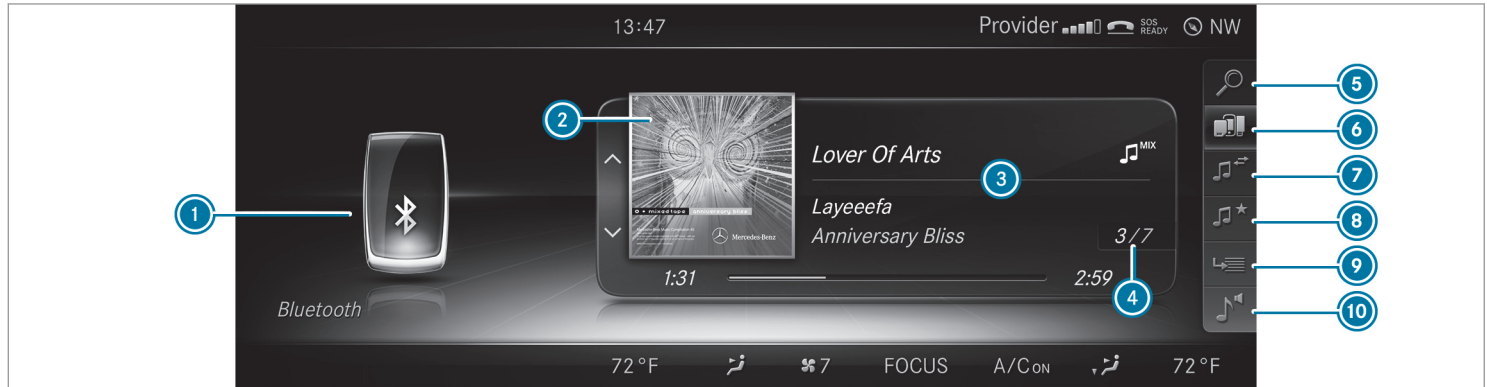

① Active data storage medium

② Cover

③ Artist, title and album

④ Track number and number of tracks in the track list

⑤ Search

⑥ Devices

⑦ Media list

⑧ Media favorites

⑨ Options

⑩ Sound settings

De-authorizing (de-registering) the Bluetooth® audio equipment

Multimedia system:

↳ Media ▶  Devices

- ▶ Select Bluetooth® audio equipment.
- ▶ Select  Options.
- ▶ Select Deauthorize.

- ▶ Select Yes.
The device will be deleted from the Bluetooth® device list.

Radio

Switching on the radio

Multimedia system:

↳ Radio

- ▶ Alternatively; press the  button.
The radio display appears. You will hear the last station played on the last frequency band selected.

Radio overview

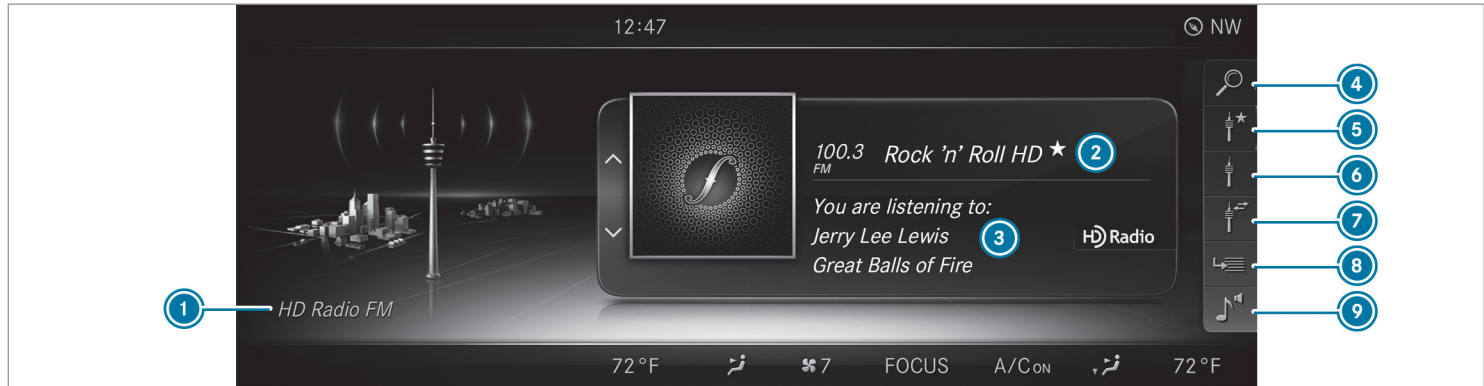

- ① Active frequency band
- ② Channel name
- ③ Artist, track and radio text

- ④ Search/station list
- ⑤ Favorite stations/radio station presets
- ⑥ Frequency bands

- ⑦ Online services
- ⑧ Options
- ⑨ Sound settings

Switching HD radio on/off

Multimedia system:

↳ Radio ▶ [Menu] Options ▶ HD Radio



- ▶ Activate or deactivate the function.
- ① HD Radio™ and the HD, HD radio, and “Arc” logos are proprietary trademarks of iBiquity Digital Corp.

Setting the frequency band

Multimedia system:

↳ Radio ▶ [F] Frequenzband

- ▶ Select a frequency band.

Selecting a radio station

Multimedia system:

↳ Radio

- ▶ Navigate up or down.

Calling up the radio station list

Multimedia system:

↳ Radio ▶ [Search] ▶ Current Channel List

- ▶ Select a channel.

Searching for radio stations using station names or direct frequency entry

Multimedia system:

↳ Radio ▶ [Search] ▶ Current Channel List
▶ [Search]

- ▶ Enter a station name or frequency.
- ▶ Select [ok].
- ▶ Results are displayed.
- ▶ Select a channel.

Storing radio stations

Multimedia system:

↳ Radio ▶ [F] Presets

- ▶ Select Add Current Station to Presets.

Editing radio station presets

Multimedia system:

↳ Radio ▶ [F] Presets

Deleting stations:

- ▶ Highlight the preset entry and navigate to the left.
- ▶ Select Delete Highlighted Station/Channel.
- ▶ Select Yes.

Moving stations:

- ▶ Select Move Highlighted Station/Channel.
- ▶ Select a preset.

Tagging music tracks

Multimedia system:

↳ Radio ▶ [Options]

If radio stations provide the relevant information, this function allows you to transfer information on the music track currently playing to an Apple® device. You can then purchase the audio file from the iTunes Store®.

- ▶ Select **Tag This Song**.
The track information is saved.

Displaying radio text

Multimedia system:

↳ Radio ▶ [Options] ▶ Display Radio Text Information

- ▶ Switch the function on .

Satellite radio

Information on the satellite radio

SIRIUS XM® Satellite Radio offers more than 140 digital-quality radio channels providing 100%

commercial-free music, sports, news and entertainment, for example. SIRIUS XM satellite radio employs a fleet of high-performance satellites to broadcast around the clock throughout the USA and Canada. The satellite radio program is available for a monthly fee. Details are available from the SIRIUS XM® service center and at <http://www.siriusxm.com> (USA) or <http://www.siriusxm.ca> (Canada). Your new Mercedes-Benz vehicle comes with SIRIUS XM® Satellite Radio pre-installed at the factory. This service is free for a six-month trial period. About a month before the trial period ends, information will be provided on how to extend this subscription. An audible signal sounds and a message is shown, describing how the subscription can be extended.

- ⓘ Sirius, XM and all related marks and logos are trademarks of Sirius XM Radio Inc. and its subsidiaries. All other marks, channel names and logos are the property of their respective owners. All rights reserved.

Restrictions on the satellite radio

Satellite radio mode may be temporarily unavailable or interrupted for a variety of reasons.

These include environmental or topographical conditions beyond the control of Mercedes-Benz USA, LLC. Thus operation at certain locations may not be possible.

Registering satellite radio

Prerequisites

The satellite radio mode requires satellite radio equipment and registration with a satellite radio provider. If registration is not included when purchasing the system, your credit card details will be required to activate your account.

Multimedia system:

↳ Radio ▶ [Frequenzband] ▶ Satellite Radio ▶ [Options]

- ▶ Select **Service Information**.
The service information screen appears.
- ▶ Establish a telephone connection.
- ▶ Follow the service staff's instructions.
The activation process may take up to ten minutes.

i You can also have the satellite service activated online. To do so, please visit

<http://www.siriusxm.com> (USA) or
<http://www.siriusxm.ca> (Canada).

Switching on satellite radio

Multimedia system:

➔ Radio ➔  Frequenzband

▶ Select Satellite Radio.

Overview of the satellite radio

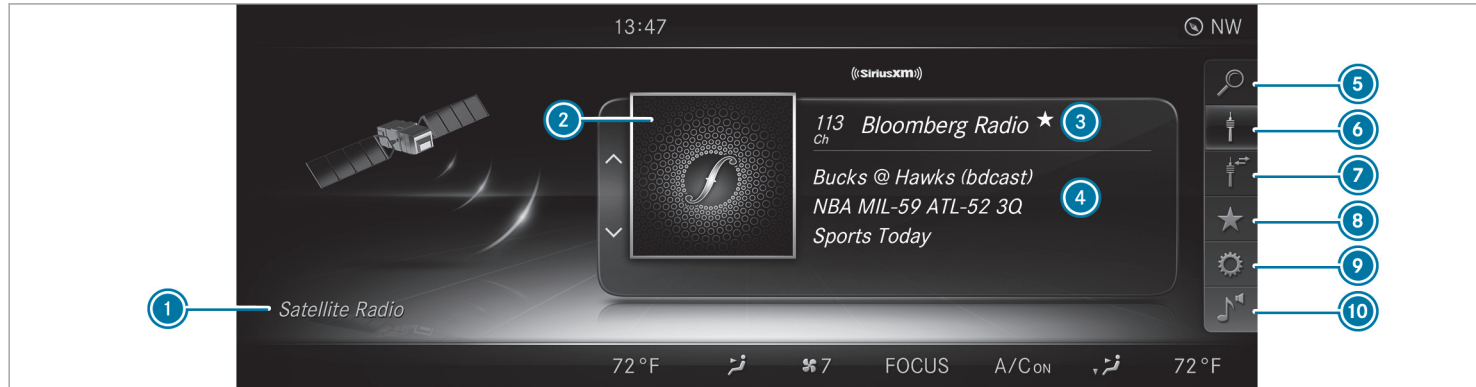

- ① Active frequency band
- ② Logo (if available)



- ③ Channel name
- ④ Channel information

- ⑤ Search
- ⑥ Frequency band

- 7 Online services
- 8 Favorites

Selecting a satellite radio category

Multimedia system:

- ↳ Radio >>  Frequenzband
- >> Satellite Radio
- >>  SiriusXM Radio Channels >> Genres
- >> Category

- ▶ Select a category.

Selecting a satellite radio channel

Multimedia system:

- ↳ Radio >>  Frequenzband >> Satellite Radio

- ▶ Navigate up or down.

Saving or deleting a satellite radio channel

Multimedia system:

- ↳ Radio >>  Frequenzband
- >> Satellite Radio >> Presets

- ▶ Select **Add Current Station to Presets**.

- 9 Options
- 10 Tone settings

Moving a channel



- ▶ Select **Options**.
- ▶ Select **Move Highlighted Station/Channel**.
- ▶ Select a preset.

Deleting a channel

- ▶ Select **Delete Highlighted Station/Channel**.
- ▶ Select a preset.

Displaying EPG information for the current channel

Multimedia system:

- ↳ Radio >>  Frequenzband
- >> Satellite Radio >>  Options
- ▶ Select **EPG Information about Current Channel**.

Setting the parental control

Multimedia system:

- ↳ Radio >>  Frequenzband
- >> Satellite Radio >>  Options
- >> Parental Control

- ▶ Switch the function on .
- ▶ Determine a four-digit character sequence and select **OK**.
The channel is locked.

Unlocking a channel

- ▶ Enter the four-digit character sequence and select **OK**.
The channel is unlocked.

Music and sport alerts function

This function makes it possible to store a program alert for your favorite artists, tracks or sporting events. Music alerts can be saved while a track is being played. You can also specify sport alerts via the menu option. The system then continuously searches through all the chan-

nels. If a match is found with a saved message, you will be informed.

Setting music and sport alerts

Prerequisites

Switch on the following function:

- Artist Alerts

Multimedia system:

↳ Radio ▶▶  Frequenzband
 ▶▶ Satellite Radio ▶▶  Options ▶▶ Alert
 for Artist, Song & Sporting Event

Setting a music alert

- ▶ Select **Manage Artist & Song Alerts**.
- ▶ Select  Options.

The following functions are available:

- Mark This Entry
- Mark All Entries
- Unmark All Entries
- Delete This Entry
- Delete All Entries

- ▶ Select an option.
The alert is set for the current artist or track. If a match is found, a prompt appears asking whether you wish to change to the channel.

Setting a sport alert

- ▶ Select **Manage Sports Alerts**.
- ▶ Select **Add New Alert** or **Edit Alert**.
- ▶ Select a team from a league.

Displaying satellite radio service information

Multimedia system:

↳ Radio ▶▶  Frequenzband
 ▶▶ Satellite Radio ▶▶  Options

- ▶ Select **Service Information**.

Displaying satellite radio channel information

Multimedia system:

↳ Radio ▶▶  Frequenzband
 ▶▶ Satellite Radio ▶▶  Options ▶▶ Display
 Radio Text Information

- ▶ Switch the function on .

Sound

Tone settings

Information about the sound system

The sound system has a total output of 100 watts and is equipped with seven speakers. It is available for all functions in the radio and media modes.

The tone settings can be selected to suit a variety of individual audio sources.

Calling up the sound menu

Multimedia system:

↳ Media ▶▶  Sound

The following functions are available:

- Equalizer
- Balance and Fader

- ▶ Select the sound menu.

Adjusting the treble, mid-range and bass

Multimedia system:

↳ Media ▶▶  Sound ▶▶ Equalizer

- ▶ Select **Treble**, **Mid Range** or **Bass**.

- ▶ Change the settings.

Adjusting the balance/fader

Multimedia system:

↳ Media ▶  Sound ▶ Balance and Fader

- ▶ Adjust the balance and fader.
- ▶ **To exit the menu:** press the  button.

Burmester® surround sound system

Information about the Burmester® surround sound system

The Burmester® surround sound system has a total output of 590 watts and is equipped with 13 speakers. It is available for all functions in the radio and media modes.

The tone settings can be selected to suit a variety of individual audio sources.

Calling up the sound menu in the Burmester® surround sound system

Multimedia system:

↳ Media ▶  Sound

The following functions are available:

- Equalizer
- Balance and Fader
- Surround Sound
- Sound Focus

- ▶ Select the sound menu.

Adjusting the treble, mid-range and bass in the Burmester® surround sound system

Multimedia system:

↳ Media ▶  Sound ▶ Equalizer

- ▶ Select Treble, Mid Range or Bass.
- ▶ Change the settings.

Adjusting the balance/fader in the Burmester® surround sound system

Multimedia system:

↳ Media ▶  Sound ▶ Balance and Fader

- ▶ Adjust the balance and fader.
- ▶ **To exit the menu:** press the  button.

Switching surround sound on/off in the Burmester® surround sound system

Multimedia system:

↳ Media ▶  Sound ▶ Surround Sound

- ▶ Switch the function on or off .

Adjusting the sound focus in the Burmester® surround sound system

Multimedia system:

↳ Media ▶  Sound ▶ Sound Focus

- ▶ Adjust the focus.

Burmester® high-end 3D surround sound system

Information about the Burmester® high-end 3D surround sound system

The

Burmester® high-end 3D surround sound system has a total output of 1,450 watts and is equipped with 23 speakers. It is available for all functions in the radio and media modes.

The tone settings can be selected to suit a variety of individual audio sources.

Calling up the sound menu in the Burmester® high-end 3D surround sound system

Multimedia system:

→ Media →  Sound

The following functions are available:

- Equalizer
- Balance and Fader
- VIP Seat (seat-based sound optimization)
- Sound Profiles

▶ Select the sound menu.

Adjusting the treble, mid-range and bass in the Burmester® high-end 3D surround sound system

Multimedia system:

→ Media →  Sound → Equalizer

▶ Select Treble, Mid Range or Bass.

▶ Change the settings.

Adjusting the balance/fader in the Burmester® high-end 3D surround sound system

Multimedia system:

→ Media →  Sound → Balance and Fader

▶ Adjust the balance and fader.

▶ **To exit the menu:** press the  button.

Adjusting the seat-based sound optimization in the Burmester® high-end 3D surround sound system

Multimedia system:

→ Media →  Sound → VIP Seat

This setting optimizes the sound playback for the selected seat position.

▶ Switch the function on .

▶ Select the seat position.

Selecting the sound profile in the Burmester® high-end 3D surround sound system

Multimedia system:

→ Media →  Sound → Sound Profiles

The following profiles are available:

- Pure
- Easy Listening
- Live
- Surround
- 3D-Sound

▶ Select the sound profile.

ASSYST PLUS service interval display

Function of the ASSYST PLUS service interval display

The ASSYST PLUS service interval display in the instrument display provides information on the remaining time or distance before the next service due date.

You can hide this service message using the back button on the left-hand side of the steering wheel.

You can obtain further information concerning the servicing of your vehicle from a qualified specialist workshop, e.g. an authorized Mercedes-Benz service center.

Displaying the service due date

On-board computer:

↳ Service ► ASSYST PLUS

The next service due date is displayed.

► **To exit the display:** press the back button on the left-hand side of the steering wheel.

Make sure to observe the following further related subject:

- Operating the on-board computer (→ page 191).

Carrying out service work at regular intervals

! **NOTE** Premature wear through failure to observe service due dates

Service work which is not carried out at the right time or incompletely can lead to increased wear and damage to the vehicle.

- ▶ Always observe the prescribed service intervals.
- ▶ Always have the prescribed service work carried out at a qualified specialist workshop.

Special service requirements

The prescribed service interval is based on normal operation of the vehicle. Service work will need to be performed more often if the vehicle is operated under arduous conditions or increased loads, for example:

- regular city driving with frequent intermediate stops.
- if the vehicle is primarily used to travel short distances.
- for frequent operation in mountainous terrain or on poor road surfaces.
- if the engine is often left idling for long periods.
- in particularly dusty conditions and/or if air-recirculation mode is frequently used.

In these or similar operating conditions, have, for example, the interior air filter, engine air filter, engine oil and oil filter changed more frequently. The tires must be checked more frequently if the vehicle is operated under increased loads. Further information can be obtained at a qualified specialist workshop.

Battery disconnection periods

The ASSYST PLUS service interval display can only calculate the service due date when the battery is connected.

- ▶ Note down the service due date displayed in the instrument display before disconnecting the battery (→ page 261).

Engine compartment

Active hood (pedestrian protection)

Operation of the active hood (pedestrian protection)

In certain accident situations, the risk of injury to pedestrians can be reduced by the actuation of the active hood. The rear area of the engine hood is raised by approximately 85 mm.

For the drive to the workshop, reset the triggered active hood yourself. If the active hood has been triggered, pedestrian protection may be limited.

A qualified specialist workshop must re-instate the full functionality of the active hood.

The active hood is not available in all countries.

Resetting the active hood

⚠ WARNING Risk of burns from hot component parts in the engine compartment

Certain component parts in the engine compartment can be very hot, e.g. the engine, the cooler and parts of the exhaust system.

- ▶ Let the engine cool down and only touch the component parts described as follows.

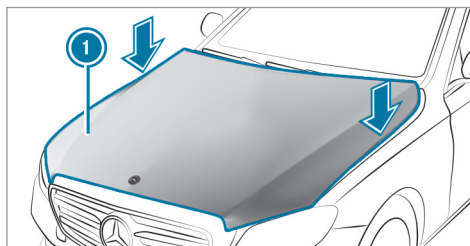

- ▶ With your hand flat, push down active hood ① in the area around the hinges on both sides (arrows). The engine hood must engage in position.
- ▶ If the active hood can be raised slightly at the rear in the area of the hinges, repeat the step until it engages correctly in position.

Opening/closing the engine hood

⚠ WARNING Risk of accident if the engine hood is unlatched while driving

An unlatched engine hood may open up when the vehicle is in motion and block your view.

- ▶ Never unlatch the engine hood while driving.
- ▶ Before every trip, ensure that the engine hood is latched.

⚠ WARNING Risk of accident and injury when opening and closing the engine hood

When opening or closing the engine hood, it may suddenly drop into the end position.

There is a risk of injury for anyone in the engine hood's range of movement.

- ▶ Only open or close the engine hood when there are no persons in the engine hood's range of movement.

⚠ WARNING Danger of burns when opening the engine hood

If you open the engine hood when the engine has overheated or during a fire in the engine compartment, you could come into contact with hot gases or other escaping operating fluids.

- ▶ Before opening the engine hood, allow the engine to cool down.

- ▶ In the event of a fire in the engine compartment, keep the engine hood closed and call the fire service.

⚠ WARNING Risk of injury due to moving parts

Certain components in the engine compartment may continue to move or suddenly move again even after the ignition has been switched off, e.g. the cooler fan.

Make sure of the following before performing tasks in the engine compartment:

- ▶ Switch the ignition off.
- ▶ Never touch the danger zone surrounding moving component parts, e.g. the rotation area of the fan.
- ▶ Remove jewelry and watches.
- ▶ Keep items of clothing and hair away from moving parts.

⚠ WARNING Risk of injury from touching component parts under voltage

The ignition system and the fuel injection system work under high voltage. If you touch component parts which are under voltage, you could receive an electric shock.

- ▶ Never touch component parts of the ignition system or the fuel injection system when the ignition is switched on.

⚠ WARNING Risk of burns from hot component parts in the engine compartment

Certain component parts in the engine compartment can be very hot, e.g. the engine, the cooler and parts of the exhaust system.

- ▶ Let the engine cool down and only touch the component parts described as follows.

⚠ WARNING Risk of injury from using the windshield wipers while the engine hood is open

When the engine hood is open and the windshield wipers are set in motion, you can be trapped by the wiper linkage.

- ▶ Always switch off the windshield wipers and ignition before opening the engine hood.

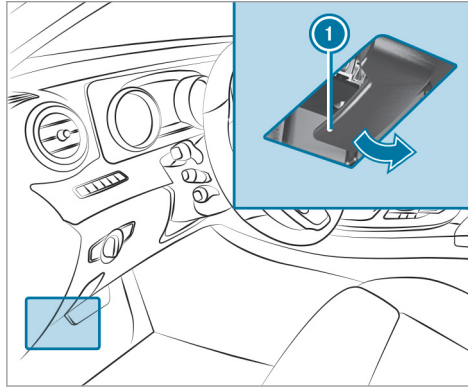

- ▶ **To open:** pull lever ❶ to release the engine hood.

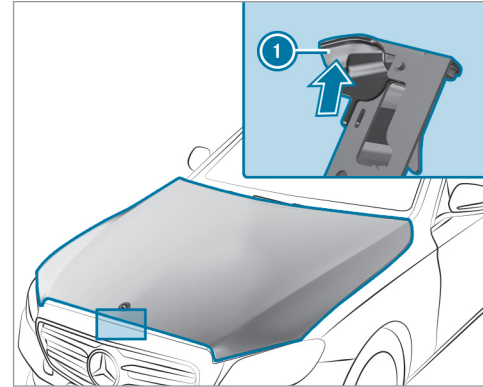

- ▶ Push hood catch ❶ upwards and lift the engine hood approximately 15 in (40 cm).
- ▶ **To close:** lower the engine hood and let it fall with a little momentum from a height of approximately 8 in (20 cm).
- ▶ If the engine hood can still be lifted slightly, open the engine hood again and close it with a little more force until it engages correctly.

Engine oil

Checking the engine oil level using the oil dipstick

⚠ WARNING Risk of burns from hot component parts in the engine compartment

Certain component parts in the engine compartment can be very hot, e.g. the engine, the cooler and parts of the exhaust system.

▶ Let the engine cool down and only touch the component parts described as follows.

Depending on the engine, the oil dipstick may be installed in the engine compartment in different locations.

Waiting time before checking the oil level:

- Engine at normal operating temperature: five minutes.
- Engine not at normal operating temperature (e.g. the engine was only started briefly): 30 minutes.

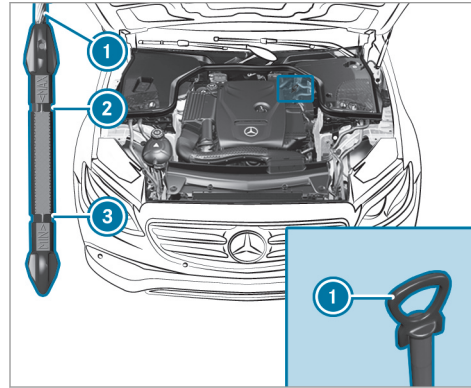

- ▶ Park the vehicle on a flat surface.
- ▶ Remove oil dipstick ① and wipe off.
- ▶ Slowly slide oil dipstick ① into the guide tube to the stop, and take it out again after approximately three seconds.
 - Oil level is correct: oil level is between ② and ③.

- Oil level too low: oil level is at ③ or below.
- ▶ If the oil level is too low, add 1.1 US qt (1 l) of engine oil.

Topping up engine oil

⚠ WARNING Risk of burns from hot component parts in the engine compartment

Certain component parts in the engine compartment can be very hot, e.g. the engine, the cooler and parts of the exhaust system.

▶ Let the engine cool down and only touch the component parts described as follows.

⚠ WARNING Risk of fire and injury from engine oil

If engine oil comes into contact with hot component parts in the engine compartment, it may ignite.

▶ Make sure that no engine oil is spilled next to the filler opening.

- ▶ Allow the engine to cool off and thoroughly clean the engine oil from component parts before starting the vehicle.

! **NOTE** Engine damage caused by an incorrect oil filter, incorrect oil or additives

- ▶ Do not use engine oils or oil filters which do not correspond to the specifications explicitly prescribed for the service intervals.
- ▶ Do not alter the engine oil or oil filter in order to achieve longer change intervals than prescribed.
- ▶ Do not use additives.
- ▶ Follow the instructions in the service interval display regarding the oil change.

! **NOTE** Damage caused by topping up too much engine oil

Topping up too much engine oil can cause damage to the engine or the catalytic converter.

- ▶ Have excess engine oil siphoned off at a qualified specialist workshop.

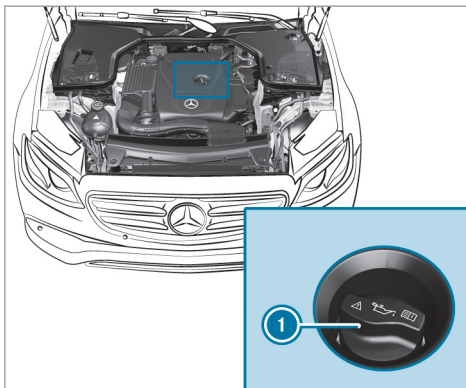

- ▶ Turn cap ① counter-clockwise and remove it.
- ▶ Add engine oil.
- ▶ Replace cap ① and turn it clockwise as far as it will go.
- ▶ Check the oil level again (→ page 265).

Checking the coolant level

! **WARNING** Risk of burns from hot component parts in the engine compartment

Certain component parts in the engine compartment can be very hot, e.g. the engine, the cooler and parts of the exhaust system.

- ▶ Let the engine cool down and only touch the component parts described as follows.

! **WARNING** Danger of burns from hot coolant

The engine cooling system is pressurized, particularly when the engine is warm. If you

open the cap, you could be scalded by hot coolant spraying out.

- ▶ Let the motor cool down before opening the cap.
- ▶ When opening the cap, wear gloves and protective eyewear.
- ▶ Slowly turn the cap half a turn to allow pressure to escape.

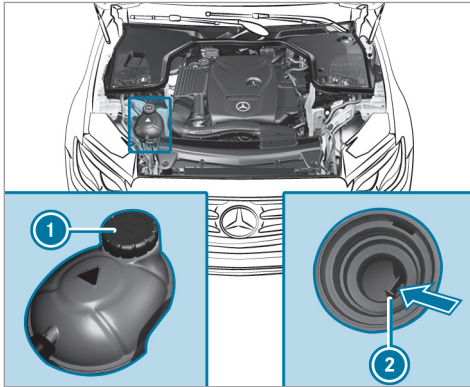

- ▶ Park the vehicle on a flat surface.
- ▶ Check the coolant temperature display in the instrument cluster. The coolant temperature must be below 158 °F (70 °C).
- ▶ Slowly turn cap ① counter-clockwise to relieve overpressure.
- ▶ Continue turning cap ① counter-clockwise and remove it.

The coolant level is correct:

- If the engine is cold, up to marker bar ②
- If the engine is warm, up to 0.6 in (1.5 cm) over marker bar ②
- ▶ If necessary, add coolant that has been tested and approved by Mercedes-Benz.
- Further information on coolant (→ page 331)

Refilling the windshield washer system

⚠ WARNING Risk of burns from hot component parts in the engine compartment

Certain component parts in the engine compartment can be very hot, e.g. the engine, the cooler and parts of the exhaust system.

- ▶ Let the engine cool down and only touch the component parts described as follows.

⚠ WARNING - Risk of fire and injury from windshield washer concentrate

Windshield washer concentrate is highly flammable. It could ignite if it comes into contact with hot engine component parts or the exhaust system.

- ▶ Make sure that no windshield washer concentrate spills out next to the filler opening.

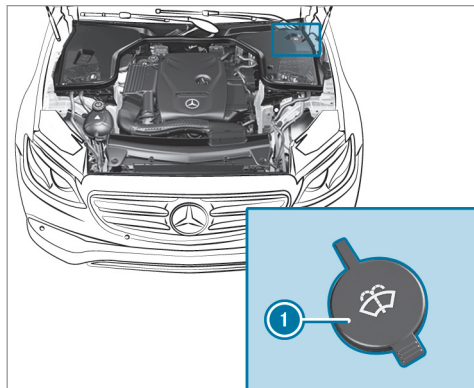

- ▶ Pull cap ① off by the tab.
- ▶ Refill washer fluid.

Cleaning and care

Information on washing the vehicle in a car wash

⚠ WARNING Risk of accident due to reduced braking effect after washing the vehicle

The braking effect is reduced after washing the vehicle.

- ▶ After the vehicle has been washed, brake carefully while paying attention to the traffic conditions until the braking effect has been fully restored.

To avoid damage to your vehicle when using a car wash, ensure the following beforehand:

- DISTRONIC PLUS and the HOLD function are switched off.
- The 360° Camera or the reversing camera is switched off.
- The side windows and sliding sunroof are completely closed.

- The blower for the ventilation/heating is switched off.
 - The windshield wiper switch is in position **0**.
 - In car washes with a towing mechanism: neutral **N** is engaged.
 - The SmartKey is at a distance of at least 10 ft (3 m) away from the vehicle, otherwise the trunk lid could open unintentionally.
- ① If you remove the wax from the windshield and the wiper rubber after the car wash you will avoid smearing and reduce wiper noise.

Notes on using high-pressure cleaning equipment

⚠ WARNING Risk of accident when using high-pressure cleaning equipment with round-spray nozzles

The water jet from a round-spray nozzle (dirt grinder) may cause damage to tires and suspension components that is not visible. Components damaged in this way may fail unexpectedly.

- ▶ Do not use high-pressure cleaning equipment with round-spray nozzles to clean your vehicle.
- ▶ Damaged tires or suspension components must be replaced immediately.

To avoid damage to your vehicle, bear the following in mind when using high-pressure cleaning equipment:

- the key must be at a distance of at least 10 ft (3 m) from the vehicle. Otherwise the trunk lid may open unintentionally.

- maintain a distance of at least 11.8 in (30 cm) to the vehicle and observe the information in the manufacturer's operating instructions for the equipment.
- do not point the nozzle of the high-pressure cleaning equipment directly at sensitive parts such as tires, slits, electrical component parts, batteries, light sources and ventilation slots.

Washing the vehicle by hand

Observe legal requirements, for example in some countries washing by hand is only allowed at specially equipped washing bays.

- ▶ Use a mild cleaning agent such as car shampoo.
- ▶ Wash the vehicle with lukewarm water and a soft car sponge. While doing so, do not expose the vehicle to direct sunlight.
- ▶ Hose down the vehicle carefully with water and dry it with a leather cloth. Make sure that the water jet is not pointed directly into the air inlet grille.

Notes on paintwork/matt finish care

	Information on cleaning and care	Avoiding damage to the paintwork
Paint	<ul style="list-style-type: none"> • Insect remains: soak with insect remover and rinse off the treated areas afterwards. • Bird droppings: soak with water and rinse off afterwards. • Coolant, brake fluid, tree resins, oils, fuel and greases: gently rub with a cloth soaked in petroleum ether or lighter fluid. • Tar stains: use tar remover. • Wax: use silicone remover. 	<ul style="list-style-type: none"> • Do not apply stickers, films etc. • Remove dirt immediately, where possible.
Matt finish	<ul style="list-style-type: none"> • The vehicle should preferably be washed by hand using a soft sponge, car shampoo and plenty of water. • Only use care products recommended by Mercedes-Benz. 	<ul style="list-style-type: none"> • Do not polish the vehicle and light-alloy wheels. • Do not have your vehicle cleaned at an automatic car wash too frequently and do not use wash programs which finish with a hot wax vehicle treatment. • Do not use paint cleaner, buffing or polishing products such as a gloss preserver, e.g. wax. • Always have paintwork repairs carried out at a qualified specialist workshop.

Notes on care of vehicle parts

⚠ WARNING Risk of entrapment if the windshield wipers are switched on while the windshield is being cleaned

If the windshield wipers are set in motion while you are cleaning the windshield or wiper blades, you can be trapped by the wiper arm.

▶ Always switch off the windshield wipers and the ignition before cleaning the windshield or wiper blades.

⚠ WARNING Risk of burns from tailpipes and tailpipe trim

The tailpipe and tailpipe trim can become very hot. If you come into contact with these parts of the vehicle, you could burn yourself.

▶ Always be particularly careful around the tailpipe and the tailpipe trim.
▶ Allow the vehicle parts to cool down before you touch them.

	Information on cleaning and care	Avoiding vehicle damage
Wheels/rims	Use water and acid-free wheel cleaners.	<ul style="list-style-type: none"> • Do not use acidic wheel cleaners to remove brake dust. This could damage wheel bolts and brake components. • To avoid corrosion of the brake disks and brake linings, drive the vehicle for a few minutes after cleaning before parking it. The brake disks and brake linings warm up and dried out.
Windows	Clean the windows on the inside and outside using a damp cloth and cleaning products recommended by Mercedes-Benz.	Do not use dry cloths, abrasive products or cleaning agents containing solvents to clean the inside of the windows.
Wiper blades	Fold out the wiper blades and clean them using a damp cloth.	Do not clean the wiper blades too often.

	Information on cleaning and care	Avoiding vehicle damage
Exterior lighting	Clean the lens with a wet sponge and mild detergent, e. g. car shampoo.	Only use cleaning agents or cleaning cloths that are suitable for plastic lenses.
AIRPANEL	<p>If the vehicle is very dusty or there are salt deposits in the AIRPANEL mechanics, the adjustment range of the shutters in the radiator trim may be restricted.</p> <ul style="list-style-type: none"> • Switch on the ignition, and the shutters open automatically after approximately 120 seconds. • Clean the bearing points of the shutters with a high-pressure water jet. 	When using a high-pressure water jet, maintain a minimum distance of 11.8 in (30 cm).
Sensors	Clean the sensors in the front and rear bumpers and in the radiator grille with a soft cloth and car shampoo.	When using a high-pressure water jet, maintain a minimum distance of 11.8 in (30 cm).
Reversing camera and 360° Camera	<ul style="list-style-type: none"> • Open the camera cover with the multimedia system(→ page 177) . • Use clear water and a soft cloth to clean the camera lens. 	Do not use a high-pressure water jet.

	Information on cleaning and care	Avoiding vehicle damage
Tailpipes	Clean with cleaning agents recommended by Mercedes-Benz, particularly in the winter and after washing the vehicle.	Use acid-free cleaning agents.
Trailer hitch	<ul style="list-style-type: none"> • Remove rust on the ball, e.g. with a wire brush. • Remove dirt with a lint-free cloth. • After cleaning, oil or grease the ball head lightly. • Observe the cleaning instructions in the operating instructions of the trailer hitch manufacturer. 	Do not clean the ball neck with solvents or a power washer.

Notes on care of the interior

⚠ WARNING Risk of injury from plastic parts breaking off after the use of solvent-based care products

Care and cleaning products containing solvents can cause surfaces in the cockpit to become porous.

When the airbags are deployed, plastic parts may break away.

- ▶ Do not use any care or cleaning products containing solvents to clean the cockpit.

⚠ WARNING Risk of injury or death from bleached seat belts

Bleaching or dyeing seat belts can severely weaken them.

This can, for example, cause seat belts to tear or fail in an accident.

- ▶ Never bleach or dye seat belts.

	Information on cleaning and care	Avoiding vehicle damage
Seat belts	Clean with warm water and soap solution.	<ul style="list-style-type: none"> Do not use chemical cleaning agents. Do not dry seat belts by heating them to over 176 °F (80 °C) or exposing them to direct sunlight.
Display	Clean the surface carefully with a microfiber cloth and TFT/LCD display cleaner.	<ul style="list-style-type: none"> Switch off the display and allow to cool. Do not use any other cleaning products.
Plastic trim	<ul style="list-style-type: none"> Clean with a damp microfiber cloth. If the trim is very dirty: use a cleaning agent recommended by Mercedes-Benz. 	<ul style="list-style-type: none"> Do not apply stickers, films etc. Do not allow cosmetics, insect repellent or sun cream to come in contact with the plastic trim.
Genuine wood/trim	<ul style="list-style-type: none"> Clean with a microfiber cloth. Black piano-lacquer look: clean with a damp cloth and soap solution. If the trim is very dirty: use a cleaning agent recommended by Mercedes-Benz. 	Do not use solvent-based cleaning agents, polishes or waxes.
Roof lining	Clean with a brush or dry shampoo.	
Carpet	Use carpet and textile cleaning agents recommended by Mercedes-Benz.	

	Information on cleaning and care	Avoiding vehicle damage
Genuine leather seat covers	<ul style="list-style-type: none"> • Clean with a damp cloth and then wipe with a dry cloth. • Leather care: use leather care agents that have been recommended by Mercedes-Benz. 	<p>Do not allow the leather to become too damp.</p> <p>Do not use a microfiber cloth.</p>
DINAMICA seat covers	Clean with a damp cloth.	Do not use a microfiber cloth.
Artificial leather seat covers	Clean with a damp cloth and 1% soap solution.	Do not use a microfiber cloth.
Cloth seat covers	Clean with a damp cloth and 1% soap solution and allow to dry.	
EASY-PACK trunk box	Clean with a damp cloth.	Do not use any alcohol-based thinners, gasoline or abrasive cleaning agents.

Emergency

Removing the safety vest

The safety vests are located in the safety jacket compartments in the front door stowage compartments.

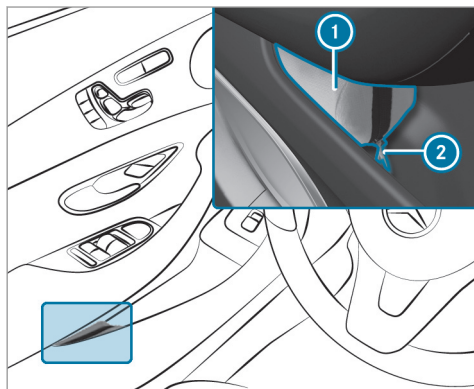

▶ **To remove:** pull out safety vest bag ① by loop ②.

▶ Open safety vest bag ① and pull out the safety vest.

① There are also safety vest compartments in the stowage compartments of the rear doors, where safety vests can be stowed.

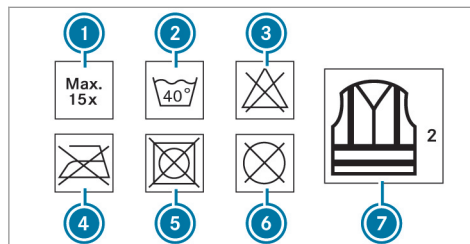

- ① Maximum number of washes
- ② Maximum wash temperature
- ③ Do not bleach
- ④ Do not iron
- ⑤ Do not use a laundry dryer
- ⑥ Do not dry-clean
- ⑦ This is a class 2 vest

The requirements defined by the legal standard are only fulfilled if the safety vest is the correct size and is fully closed.

Replace the safety vest, if:

- it is damaged or dirt on the reflective strips can no longer be removed.
- the maximum number of washes is exceeded.
- the fluorescence of the safety vest has faded.

First-aid kit (soft sided)

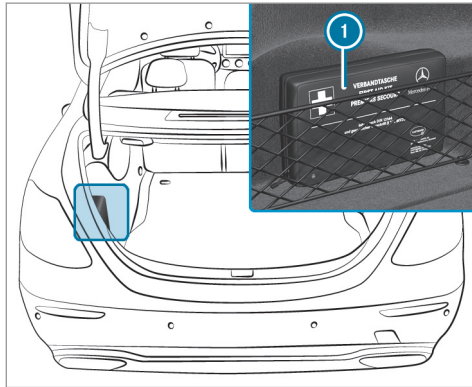

First-aid kit (soft sided) ① is in the trunk in the left-hand stowage net.

Vehicle tool kit

Overview of the tire-change tool kit

Apart from certain country-specific variations, the vehicles are not equipped with a tire-change tool kit.

The tire-change tool kit is located under the trunk floor.

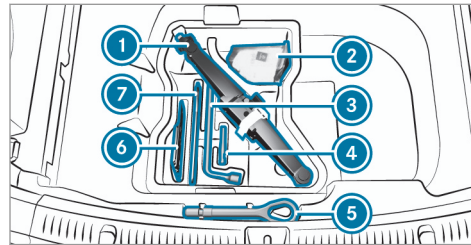

- ① Jack
- ② Gloves
- ③ Wheel wrench
- ④ Centering pin
- ⑤ Towing eye

- ⑥ Folding wheel chock
- ⑦ Ratchet for jack

All vehicles are equipped with towing eye ⑤.

Further information on the required tire-change tool kit can be obtained at a qualified specialist workshop.

Setting up the chock

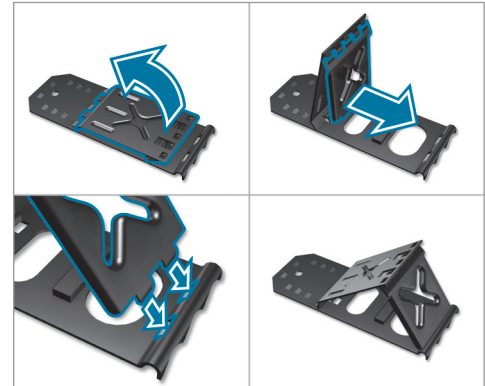

TIREFIT kit storage location

The TIREFIT kit is located on the left-hand side under the trunk floor.

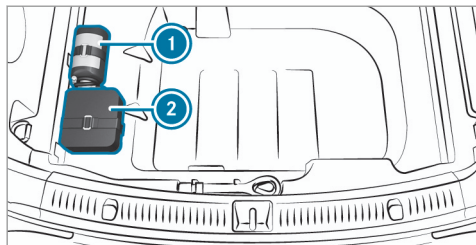

- ① Tire sealant bottle
- ② Tire inflation compressor

Flat tire

Notes on flat tires

⚠ WARNING Risk of accident due to a flat tire

A flat tire severely affects the driving characteristics as well as the steering and braking behavior of the vehicle.

Tires without run-flat characteristics:

- ▶ Do not drive on with a flat tire.
- ▶ Replace the flat tire immediately with the emergency spare wheel/ spare wheel or consult a qualified specialist workshop.
- ▶ **Run-flat tires:** Observe the information and warning notices for MOExtended tires (run-flat tires).

In the event of a flat tire, the following options are available depending on your vehicle's equipment:

- **Vehicles with MOExtended tires:** it is possible to continue the journey for a short

period of time. Make sure you observe the notes on MOExtended tires (run-flat tires) (→ page 278).

- **Vehicles with a TIREFIT kit:** you can repair the tire and continue the journey for a short period of time only. To do this, use the TIREFIT Kit (→ page 279).
- **Vehicles with a Mercedes-Benz emergency call system:** in the event of a flat tire, consult the Customer Center of the Mercedes-Benz emergency call system.
- Change the wheel (→ page 319).

MOExtended tires (run-flat tires)

With MOExtended tires (run-flat tires), you can continue to drive your vehicle even if there is a total loss of pressure in one or more tires. However, the tire affected must not show any clearly visible damage.

You can recognize MOExtended tires by the MOExtended marking which appears on the side wall of the tire.

Vehicles with a tire pressure monitoring system: MOExtended tires may only be used in conjunction with an activated tire pressure monitoring system.

If a pressure loss warning message appears in the multifunction display:

- Check the tire for damage.
- If driving on, observe the following notes.

⚠ WARNING Risk of accident when driving in limp-home mode

When driving in limp-home mode, the handling characteristics are impaired. e.g. when cornering, when accelerating strongly and when braking.

- ▶ Do not exceed the maximum permissible speed.
- ▶ Avoid any abrupt steering and driving maneuvers as well as driving over obstacles (curbs, pot holes, cross-country). This applies, in particular, to a loaded vehicle.

▶ Stop driving in limp-home mode if you notice:

- banging noise
- vehicle vibration
- smoke which smells like rubber
- continuous ESP® intervention
- cracks in tire side walls

▶ After driving in limp-home mode, have the rims checked by a qualified specialist workshop with regard to their further use.

▶ The defective tire must be replaced in every case.

After the pressure loss warning, the driving distance possible in run-flat mode is:

Load condition	Driving distance possible in run-flat mode
Partially laden	50 miles (80 km)
Fully laden	19 miles (30 km)

- The driving distance possible in run-flat mode may vary depending on the driving style.
- Maximum permissible speed 50 mph (80 km/h).

If a tire has gone flat and cannot be replaced with an MOExtended tire, a standard tire may be used as a temporary measure.

Using the TIREFIT kit

Have the following readily available:

- Tire sealant bottle
- Enclosed TIREFIT sticker
- Tire inflation compressor

You can use TIREFIT tire sealant to seal punctures of up to 0.16 in (4 mm), particularly those in the tire contact surface. You can use TIREFIT in outside temperatures down to -4 °F (-20 °C).

⚠ WARNING Risk of accident when using tire sealant

In the following situations, the tire sealant is unable to provide sufficient breakdown assistance, as it is unable to seal the tire properly:

- There are cuts or punctures in the tire larger than those previously mentioned.
 - The wheel rim is damaged.
 - You have driven at very low tire pressures or on a flat tire.
- ▶ Do not drive any further.
- ▶ Consult a qualified specialist workshop.

⚠ WARNING Risk of injury and poisoning from tire sealant

The tire sealant is harmful and causes irritation. Do not allow it to come into contact with the skin, eyes or clothing, and do not swallow it. Do not inhale tire sealant fumes. Keep the tire sealant away from children.

If you come into contact with the tire sealant, observe the following:

- ▶ Rinse off the tire sealant from your skin immediately using water.
- ▶ If tire sealant gets into your eyes, thoroughly rinse out the eyes using clean water.
- ▶ If tire sealant has been swallowed, immediately rinse out the mouth thoroughly and drink plenty of water. Do not induce vomiting and seek medical attention immediately.
- ▶ Change out of any clothes contaminated with tire sealant immediately.
- ▶ If allergic reactions occur, seek medical attention immediately.

! NOTE Overheating due to the tire inflation compressor running too long

- ▶ Do not run the tire inflation compressor for longer than ten minutes without interruption.

Comply with the manufacturer's safety note on the sticker on the tire inflation compressor.

Have the tire sealant bottle replaced every four years at a qualified specialist workshop.

- ▶ Do not remove any foreign objects which have penetrated the tire.

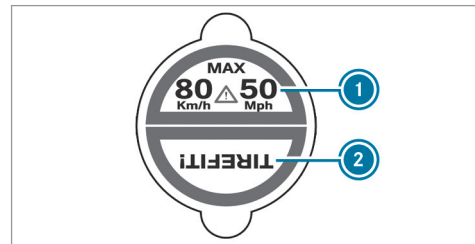

- ▶ Affix part ① of the TIREFIT sticker to the instrument cluster within the driver's field of vision.
- ▶ Affix part ② of the TIREFIT sticker near the valve on the wheel with the defective tire.

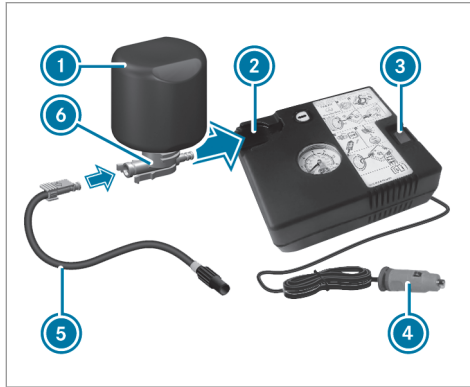

- ▶ Pull connector ④ with cable and hose ⑤ out of the tire inflation compressor housing.
- ▶ Push the connector on hose ⑤ into flange ⑥ on tire sealant bottle ① until the connector engages.
- ▶ Place tire sealant bottle ① head downwards into recess ② of the tire inflation compressor.

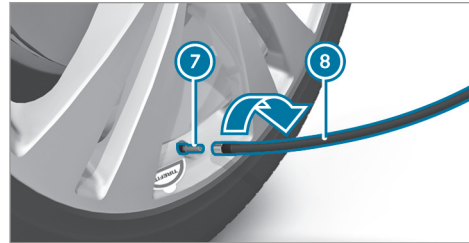

- ▶ Remove the valve cap from valve ⑦ of the defective tire.
- ▶ Screw filling hose ⑧ onto valve ⑦.
- ▶ Insert plug ④ into a 12 V socket in your vehicle.
- ▶ Switch on the ignition.
- ▶ Press on and off switch ③ on the tire inflation compressor. The tire inflation compressor is switched on. The tire is inflated. First, tire sealant is pumped into the tire. The pressure may briefly rise to approximately 500 kPa (5 bar/73 psi).

Do not switch off the tire inflation compressor during this phase.

- ▶ Let the tire inflation compressor run for a maximum of ten minutes. The tire should then have attained a tire pressure of at least 200 kPa (2.0 bar/29 psi).

If tire sealant has escaped, clean it off affected areas as quickly as possible. Use plain water if possible.

If your clothes are soiled with tire sealant, have them cleaned with perchloroethylene at a dry cleaner as soon as possible.

If, after ten minutes, a tire pressure of 200 kPa (2.0 bar/29 psi) has not been achieved:

- ▶ Switch off the tire inflation compressor.
- ▶ Unscrew the filling hose from the valve of the faulty tire.

Note that tire sealant may escape when you unscrew the filling hose.

- ▶ Very slowly drive forwards or reverse approximately 33 ft (10 m).
- ▶ Pump up the tire again.
After a maximum of ten minutes the tire pressure must be at least 200 kPa (2.0 bar/29 psi).

⚠ WARNING Risk of accident in the event of the specified tire pressure not being reached

If the minimum tire pressure is not reached after the specified time, the tire is too badly damaged. The tire sealant cannot repair the tire in this instance.

Damaged tires and tire pressure that is too low can significantly impair the braking properties and the handling characteristics.

- ▶ Do not continue driving.
- ▶ Consult a qualified specialist workshop.

If, after ten minutes, a tire pressure of 200 kPa (2.0 bar/29 psi) has been achieved:

⚠ WARNING Risk of accident from driving with sealed tires

A tire temporarily sealed with tire sealant impairs the handling characteristics and is not suitable for higher speeds.

- ▶ Adapt your driving style accordingly and drive carefully.
- ▶ Do not exceed the specified maximum speed with a tire that has been repaired using tire sealant.

- ▶ Observe the maximum permissible speed for a tire sealed with tire sealant: 50 mph (80 km/h).
- ▶ Affix the upper section of the TIREFIT sticker to the Instrument Cluster where it will be easily seen by the driver.

! **NOTE** Staining caused by leaking tire sealant

After use, excess tire sealant may leak out from the filling hose.

- ▶ Therefore, place the filling hose in the plastic bag that contained the TIREFIT kit.

! **ENVIRONMENTAL NOTE** Environmental pollution caused by environmentally irresponsible disposal

Tire sealant contains pollutants.

- ▶ Have the tire sealant bottle disposed of professionally, e.g. at a Mercedes-Benz service center.

- ▶ Switch off the tire inflation compressor.
- ▶ Unscrew the filling hose from the valve of the faulty tire.
- ▶ Stow the tire sealant bottle, the tire inflation compressor and the warning triangle.
- ▶ **Pull away immediately.**

- ▶ Stop after driving for approximately ten minutes and check the tire pressure with the tire inflation compressor. The tire pressure must now be at least 130 kPa (1.3 bar/19 psi).

⚠ WARNING Risk of accident due to the specified tire pressure not being reached

If the specified tire pressure after a brief drive is not reached, the tire is too badly damaged. The tire sealant cannot repair the tire in this instance.

Damaged tires and tire pressure that is too low can significantly impair braking properties and handling characteristics.

- ▶ Do not continue driving.
- ▶ Consult a qualified specialist workshop.

In cases such as the one mentioned above, contact an authorized Mercedes-Benz Center. Or call 1-800-FOR-MERCEdes (in the USA) or 1-800-387-0100 (in Canada).

- ▶ Correct the tire pressure if it is still at least 130 kPa (1.3 bar/19 psi). See the Tire and

Loading Information placard on the driver's side B-pillar or the tire pressure table in the fuel filler flap for values.

- ▶ **To increase the tire pressure:** switch on the tire inflation compressor.

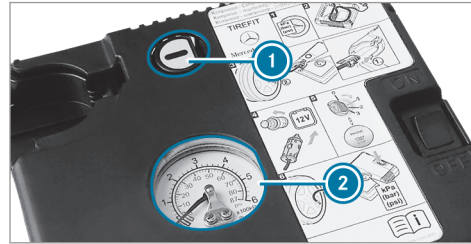

- ▶ **To reduce the tire pressure:** press pressure release button ① next to manometer ②.
- ▶ When the tire pressure is correct, unscrew the filling hose from the valve of the sealed tire.
- ▶ Screw the valve cap onto the tire valve of the sealed tire.

- ▶ Pull the tire sealant bottle out of the tire inflation compressor. The filling hose remains attached to the tire sealant bottle.
- ▶ Drive to the nearest qualified specialist workshop and have the tire, tire sealant bottle and filling hose replaced there.

Battery (vehicle)

Notes on the 12 V battery

⚠ WARNING Risk of an accident due to work carried out incorrectly on the battery

Work carried out incorrectly on the battery can lead to a short circuit, for example. This can lead to function restrictions applying to safety-relevant systems, e.g. the lighting system, ABS (anti-lock braking system) or ESP® (Electronic Stability Program).® The operating safety of your vehicle may be restricted.

You could lose control of the vehicle in the following situations:

- when braking
- in the event of abrupt steering maneuvers and/or when the vehicle's speed is not adapted to the road conditions
- ▶ In the event of a short circuit or a similar incident, contact a qualified specialist workshop immediately.
- ▶ Do not drive any further.
- ▶ Always have work on the battery carried out at a qualified specialist workshop.

- Further information on ABS (→ page 147)
- Further information on ESP® (→ page 148)

For safety reasons, Mercedes-Benz recommends that you only use batteries which have been tested and approved for your vehicle by Mercedes-Benz. These batteries provide increased impact protection to prevent vehicle occupants from suffering acid burns should the battery be damaged in the event of an accident.

All vehicles except vehicles with a lithium-ion battery

⚠ WARNING Risk of explosion due to electrostatic charge

Electrostatic charge can cause sparks which may ignite the highly flammable gas mixture in the battery.

- ▶ To discharge any electrostatic charge that may have built up, touch the metal vehicle body before handling the battery.

The highly flammable gas mixture is created while the battery is charging and during starting assistance.

⚠ WARNING Danger of chemical burns from the battery acid

Battery acid is caustic.

- ▶ Avoid contact with the skin, eyes or clothing.
- ▶ Do not lean over the battery.

- ▶ Do not inhale battery gases.
- ▶ Keep children away from the battery.
- ▶ Immediately rinse battery acid off thoroughly with plenty of clean water and seek medical attention immediately.

All vehicles

! **ENVIRONMENTAL NOTE** Environmental damage caused by improper disposal of batteries



Batteries contain pollutants. It is illegal to dispose of them with the household rubbish.



Dispose of batteries in an environmentally responsible manner. Take discharged batteries to a qualified

specialist workshop or to a collection point for used batteries.

If you have to connect the 12 volt battery, contact a qualified specialist workshop.

Comply with safety notes and take protective measures when handling batteries.



Risk of explosion



Fire, open flames and smoking are prohibited when handling the battery. Avoid creating sparks.



Electrolyte or battery acid is corrosive. Avoid contact with skin, eyes or clothing. Wear suitable protective clothing, in particular gloves, an apron and a face mask. Immediately rinse electrolyte or acid splashes off with clean water. Contact a physician if necessary.



Wear eye protection.



Keep children away.



Observe this Operator's Manual.

If you do not intend to use the vehicle over an extended period of time:

- Activate standby mode, or
- Connect the battery to a battery charger approved by Mercedes-Benz, or
- Consult a qualified specialist workshop to disconnect the battery

Starting assistance and charging the 12 V battery

Vehicles with a lithium-ion battery

- ▶ When charging the battery and during starting assistance, always use the jump-start connection point in the engine compartment.

! **NOTE** Damage to the battery from over-voltage

When charging using a battery charger without a maximum charging voltage, the battery or the on-board electronics may be damaged.

- ▶ Only use battery chargers with a maximum charging voltage of 14.4 V.

All other vehicles

- ▶ When charging the battery and during starting assistance, always use the jump-start connection point in the engine compartment.

! **NOTE** Damaging the battery through overvoltage

When charging using a battery charger without a maximum charging voltage, the battery or the vehicle electronics may be damaged.

- ▶ Only use battery chargers with a maximum charging voltage of 14.8 V.

! **WARNING** Risk of explosion from hydrogen gas igniting

A battery generates hydrogen gas during the charging process. If there is a short circuit or sparks start to form, there is a danger of the hydrogen gas igniting.

- ▶ Make sure that the positive terminal of the connected battery does not come into contact with vehicle parts.
- ▶ Never place metal objects or tools on a battery.
- ▶ When connecting and disconnecting the battery, you must observe the described order for the battery clamps.

- ▶ When giving starting assistance, always make sure that you only connect battery terminals with identical polarity.

- ▶ During starting assistance, you must observe the described order for connecting and disconnecting the jumper cables.

- ▶ Do not connect or disconnect the battery clamps while the engine is running.

! **WARNING** Risk of explosion during charging process and starting assistance

During the charging process and starting assistance, the battery may release an explosive gas mixture.

- ▶ Avoid fire, open flames, creating sparks and smoking.
- ▶ Make sure that there is sufficient ventilation during the charging process and during starting assistance.
- ▶ Do not lean over a battery.

If the indicator/warning lamps in the instrument cluster do not light up at low temperatures, it is very likely that the discharged battery has frozen.

! **WARNING** Risk of explosion from a frozen battery

A discharged battery may freeze at temperatures slightly above or below freezing point.

During starting assistance or battery charging, battery gas may be released.

- ▶ Always thaw a frozen battery out first before charging it or performing starting assistance.

! **NOTE** Shortening the service life of the battery by charging the battery at low temperatures

Charging the battery at very low temperatures may shorten the service life of the battery and have a negative effect on starting.

- ▶ Do not charge the battery at very low temperatures.

It is recommended that you have the thawed battery checked at a qualified specialist workshop.

All vehicles

! **NOTE** Damage caused by numerous or extended attempts to start the engine

Numerous or extended attempts to start the engine may damage the catalytic converter due to non-combusted fuel.

▶ Avoid numerous and extended attempts to start the engine.

Observe the following points during starting assistance and when charging the battery:

- Only use undamaged jumper cables/charging cables with an adequate cross-section and insulated terminal clamps.
- Non-insulated parts of the terminal clamps must not come into contact with other metal parts while the jumper cables/charging cables are connected to the battery or the jump-start connection point.

- The jumper cables/charging cables must not come into contact with any parts which may move when the engine is running.
- Always make sure that neither you nor the battery are electrostatically charged.
- Keep away from fire and open flames.
- Do not lean over the battery.
- **When charging:** only use battery chargers tested and approved by Mercedes-Benz and read the battery charger's operating instructions before charging the battery.

Observe the additional following points during starting assistance:

- Starting assistance may only be provided using batteries with a nominal voltage of 12 V.
 - The vehicles must not touch.
 - **Gasoline engine:** Only accept starting assistance if the engine and exhaust system are cold.
- ▶ Secure the vehicle by applying the electric parking brake.

- ▶ **Automatic transmission:** Shift the transmission to position **P**.
- ▶ Make sure that the ignition and all electrical consumers are switched off.
- ▶ Open the engine hood.

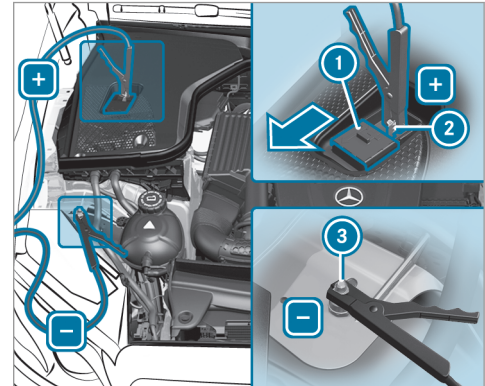

- ▶ Slide cover **1** of positive terminal **2** on the jump-starting connection point in the direction of the arrow.

- ▶ Connect positive terminal ② on your vehicle to the positive pole of the donor battery using the jumper cable/charging cable. Always begin with positive clamp ② on your own vehicle first.
- ▶ **During the starting assistance procedure:** start the engine of the donor vehicle and run at idle speed.
- ▶ Connect the negative pole of the donor vehicle and ground point ③ of your own vehicle by using the jumper cable/charging cable. Begin with the donor battery first.
- ▶ **During starting assistance:** start the engine of your own vehicle.
- ▶ **During the charging process:** start the charging process.
- ▶ **During starting assistance:** let the engines run for several minutes.
- ▶ **During starting assistance:** before disconnecting the jumper cables, switch on an electrical consumer on your own vehicle, e.g. the rear window heater or the lighting.

When the starting assistance/charging process is complete:

- ▶ First, remove the jumper cables/charging cables from ground point ③ and the negative pole of the donor battery, then from positive terminal ② and the positive pole of the donor battery. Begin each time with the contacts on your own vehicle first.
- ▶ After removing the jumper cables/charging cables, close cover ① of positive terminal ②.

You can obtain further information on starting assistance at any qualified specialist workshop.

Tow starting or towing away

Towing away the vehicle

Mercedes-Benz recommends transporting your vehicle in the case of a breakdown, rather than towing it away.

! **NOTE** Damage to the vehicle due to towing away incorrectly

- ▶ Observe the instructions and notes on towing away.

Permitted towing methods

- Vehicles with transmission damage must be transported (→ page 290).
- **Vehicles with automatic transmission:** only with both axles on the ground.
- **4MATIC vehicles:** only with both axles on the ground.

! **WARNING** Risk of accident due to limited safety-related functions during the towing process

Safety-related functions are limited or no longer available in the following situations:

- the ignition is switched off.
- the brake system or power steering system is malfunctioning.

- the energy supply or the on-board electrical system is malfunctioning.

When your vehicle is then towed away, significantly more effort may be required to steer and brake than is normally required.

- ▶ Use a tow bar.
- ▶ Make sure that the steering wheel can move freely, before towing the vehicle away.

! **NOTE** Damage due to towing away at excessively high speeds or over long distances

The drivetrain could be damaged when towing at excessively high speeds or over long distances.

- ▶ A towing speed of 31 mph (50 km/h) must not be exceeded.
- ▶ A towing distance of 31 miles (50 km) must not be exceeded.

If a vehicle must be tow started or towed away, its weight must not exceed the permissible gross mass of the towing vehicle.

! **WARNING** Risk of accident when towing a vehicle which is too heavy

If the vehicle being tow-started or towed away is heavier than the permissible gross mass of your vehicle, the following situations can occur:

- The towing eye may become detached.
 - The vehicle/trailer combination may swerve or even overturn.
- ▶ If another vehicle is tow-started or towed away, its weight must not exceed the permissible gross mass of your own vehicle.

▶ Information on the permissible gross mass of the vehicle can be found on the vehicle identification plate (→ page 326).

During the towing procedure, observe the following:

- Deactivate the DISTRONIC distance pilot.
- Do not activate the HOLD function.
- **Vehicles with automatic transmission:** Do not open the driver's door or front passenger door, otherwise the automatic transmission automatically shifts to position **P**.

▶ Make sure that the battery is connected and charged.

When the battery is discharged:

- The engine cannot be started.
 - The electric parking brake cannot be released or applied.
 - **Vehicles with automatic transmission:** The automatic transmission cannot be shifted to position **N** or **P**.
- ▶ Install the towing eye (→ page 291).
- ▶ Attach the tow bar.

! **NOTE** Damage due to incorrect connection

- ▶ Only connect the tow rope or tow bar to the towing eyes.

- ▶ Deactivate automatic locking (→ page 62).
- ▶ Deactivate Active Brake Assist (→ page 155).

▶ **Vehicles with automatic transmission:** Shift the automatic transmission to position **N**.

i **Vehicles with automatic transmission:** If the automatic transmission cannot be shifted to position **N**, have the vehicle transported away (→ page 290).

- ▶ **When towing away with the rear axle raised:** move the front wheels into the straight-ahead position.
- ▶ **When towing away with one axle raised:** switch on the power supply.
- ▶ **When towing away with both axles on the ground:** switch on the ignition.
- ▶ Release the electric parking brake.

! **NOTE** Damage due to excessive tractive power

If you pull away sharply, the tractive power may be too high and the vehicles could be damaged.

- ▶ Pull away slowly and smoothly.

Loading the vehicle for transport

Transportation of vehicles should only be carried out by professional recovery companies.

- ▶ Observe the notes on towing away (→ page 288).
- ▶ Connect the tow bar to the towing eye to load the vehicle.
- ▶ **Vehicles with automatic transmission:** Shift the automatic transmission to position **N**.
- i** **Vehicles with automatic transmission:** The automatic transmission may be locked in position **P** in the event of damage to the electrics. To shift to **N**, provide the on-

board electrical system with power (→ page 285).

- ▶ Load the vehicle onto the transporter.
- ▶ **Vehicles with automatic transmission:** Shift the automatic transmission to position **P**.
- ▶ Use the electric parking brake to secure the vehicle and prevent it from rolling away.
- ▶ Only secure the vehicle by the wheels.

4MATIC vehicles/vehicles with automatic transmission

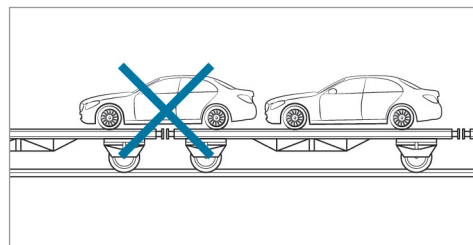

- ▶ Make sure that the front and rear axles come to rest on the same transport vehicle.

! **NOTE** Damage to the drivetrain due to incorrect positioning

▶ Do not position the vehicle above the connection point of the transport vehicle.

Installing the towing eye

i The towing eye is part of the vehicle tool kit.

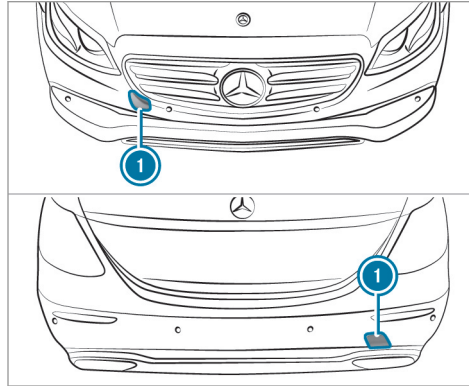

▶ Press the mark on cover **1** inwards and remove.

▶ Screw in the towing eye clockwise to the stop.

i Make sure that cover **1** engages in the bumper when you remove the towing eye.

! **NOTE** Damage due to incorrect use of the towing eye

When a towing eye is used to recover a vehicle, the vehicle may be damaged in the process.

▶ Only use the towing eye to tow away or tow start the vehicle.

Tow starting the vehicle (emergency engine start)

! **NOTE** Damage to the automatic transmission due to tow starting

The automatic transmission may be damaged in the process of tow starting vehicles with automatic transmission.

▶ Vehicles with automatic transmission must not be tow started.

Electrical fuses

Notes on electrical fuses

⚠ WARNING Risk of accident and injury due to overloaded lines

If you manipulate or bridge a faulty fuse or if you replace it with a fuse with a higher amperage, the electric line could be overloaded.

This could result in a fire.

- ▶ Always replace faulty fuses with specified new fuses containing the correct amperage.

! NOTE Damage caused by incorrect fuses

Incorrect fuses may cause damage to electrical components or systems.

- ▶ Only use Mercedes-Benz approved fuses with the correct fuse rating.

Blown fuses must be replaced with fuses of the same rating, which you can recognize by the

color and fuse rating. The fuse ratings are listed in the fuse assignment diagram.

Fuse assignment diagram: on the fuse box in the trunk (→ page 294).

! NOTE Damage or malfunctions caused by moisture

Moisture may cause damage to the electrical system or cause it to malfunction.

- ▶ When the fuse box is open, make sure that no moisture can enter the fuse box.
- ▶ When closing the fuse box, make sure that the seal of the lid is positioned correctly on the fuse box.

If the newly inserted fuse also blows, have the cause traced and rectified at a qualified specialist workshop.

Ensure the following before replacing a fuse:

- The vehicle is secured against rolling away.
- All electrical consumers are switched off.
- The ignition is switched off.

The electrical fuses are located in various fuse boxes:

- Fuse box in the engine compartment on the driver's side (→ page 292)
- Fuse box on the driver's side of the cockpit (→ page 294)
- Fuse box in the front-passenger footwell (→ page 294)
- Fuse box in the trunk on the right-hand side of the vehicle, when viewed in the direction of travel (→ page 294)

Fuse box in the engine compartment

Prerequisites

Observe the notes on electrical fuses (→ page 292).

Have the following readily available:

- A dry cloth
- A screwdriver

Opening

⚠ WARNING Risk of injury from using the windshield wipers while the engine hood is open

When the engine hood is open and the windshield wipers are set in motion, you can be trapped by the wiper linkage.

▶ Always switch off the windshield wipers and ignition before opening the engine hood.

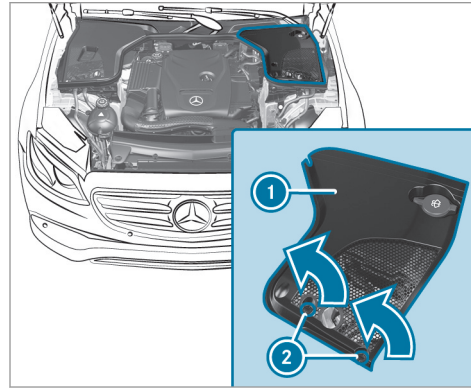

- ▶ Turn clip ② on cover ① a quarter-turn to the left.
- ▶ Pull cover ① upwards in the direction of the arrow.

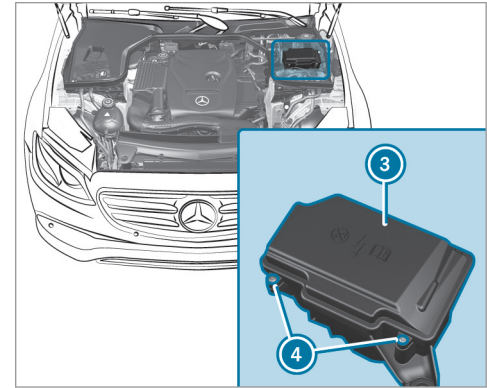

- ▶ Remove any existing moisture from the fuse box using a dry cloth.
- ▶ Loosen screws ④, remove fuse box lid ③ from the top.

Closing

- ▶ Check whether the seal is positioned correctly in the lid.

- ▶ Insert the lid into the bracket at the back of the fuse box.
- ▶ Fold down lid of the fuse box and tighten screws ④.
- ▶ Insert cover ① on both sides and engage safety clips.
- ▶ Close the engine hood.

Cockpit fuse box

The fuse box is on the side of the dashboard under a cover.

- ▶ Contact an authorized Mercedes-Benz Center for further information.

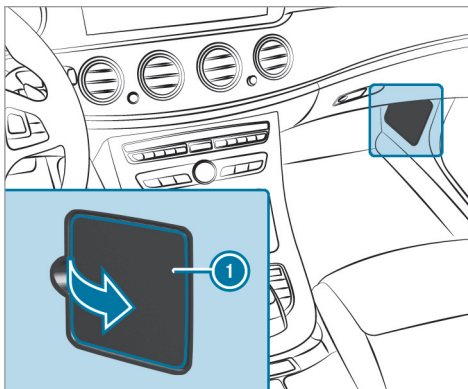

- ▶ Open cover ① in the direction of the arrow and remove it.

Fuse box in the trunk

Prerequisites

Observe the notes on electrical fuses (→ page 292).

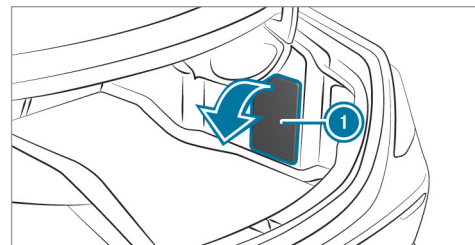

- ▶ Fold cover ① down in the direction of the arrow.

The fuse assignment diagram is in a recess on the side of the fuse box.

Noise or unusual handling characteristics

While driving, pay attention to vibrations, noises and unusual handling characteristics, e.g. pulling to one side. This may indicate that the wheels or tires are damaged. If you suspect that a tire is defective, reduce your speed immediately. Stop the vehicle as soon as possible to check the wheels and tires for damage. Hidden tire damage could also be causing the unusual handling characteristics. If you find no signs of damage, have the tires and wheels checked at a qualified specialist workshop.

Regular checking of wheels and tires

⚠ WARNING Risk of accident from damaged tires

Damaged tires can cause tire pressure loss. As a result, you could lose control of your vehicle.

- ▶ Check the tires regularly for signs of damage and replace any damaged tires immediately.

⚠ WARNING Risk of aquaplaning due to insufficient tire tread

Insufficient tire tread will result in reduced tire grip. The tire tread is no longer able to dissipate water.

This means that in heavy rain or slush the risk of hydroplaning is increased, in particular if vehicle speed is not adapted to suit the conditions.

If the tire pressure is too high or too low, tires may exhibit different levels of wear at different locations on the tire contact surface.

- ▶ Thus, you should regularly check the tread depth and the condition of the tire contact surface across the entire width of all tires.

Minimum tread depth for:

- Summer tires: $\frac{1}{8}$ in (3 mm)
- M+S tires: $\frac{1}{6}$ in (4 mm)

- ▶ For safety reasons, replace the tires before the legally prescribed limit for the minimum tread depth is reached.

Carry out the following checks on all wheels regularly, at least once a month or as required, e.g. prior to a long journey or driving off-road:

- Check the tire pressure (→ page 297).
- Visual check of wheels and tires for damage.
- Check the valve caps.

The valves must be protected against moisture and dirt by the valve caps approved especially for your vehicle by Mercedes-Benz.

- Visual check of the tread depth and the tire contact surface across the entire width.

The minimum tread depth for summer tires is $\frac{1}{8}$ in (3 mm) and for winter tires $\frac{1}{6}$ in (4 mm).

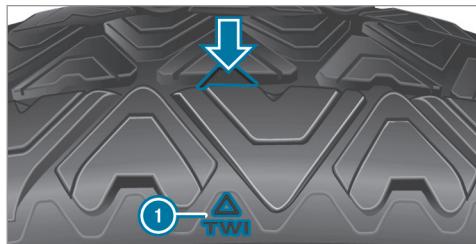

Six marks ① show where the bar indicators (arrow) are integrated into the tire tread. They are visible once a tread depth of approximately $\frac{1}{16}$ in (1.6 mm) has been reached.

Notes on snow chains

⚠ WARNING Risk of accident due to incorrect mounting of snow chains

If you have mounted snow chains to the front wheels, the snow chains may drag against the vehicle body or chassis components.

This could cause damage to the vehicle or the tires.

- ▶ Never mount snow chains on the front wheels.
- ▶ Only mount snow chains on the rear wheels in pairs.

! **NOTE** Damage to the wheel trim from mounted snow chains

If snow chains are mounted to steel wheels, the wheel trims can be damaged.

- ▶ Remove the wheel trims of steel wheels before mounting snow chains.

- Snow chains are only permissible for certain wheel/tire combinations. You can obtain information about this from an authorized Mercedes-Benz service center.
- For safety reasons, only use snow chains that have been specifically approved for your vehicle by Mercedes-Benz, or snow chains with the same quality standard.

- If snow chains are installed, the maximum permissible speed is 30 mph (50 km/h).
- **Vehicles with Parking Pilot:** Do not use Parking Assist PARKTRONIC if snow chains are installed.
- **Vehicles with AIR BODY CONTROL:** Only drive at raised vehicle level if snow chains are installed.

i Tips:

- You can deactivate ESP® to pull away (→ page 151). This allows the wheels to spin, achieving an increased driving force.

Tire pressure

Notes on tire pressure

⚠ WARNING Risk of accident due to insufficient or excessive tire pressure

Underinflated or overinflated tires pose the following risks:

- The tires may burst, especially as the load and vehicle speed increase.
 - The tires may wear excessively and/or unevenly, which may greatly impair tire traction.
 - The driving characteristics, as well as steering and braking, may be greatly impaired.
- ▶ Comply with the recommended tire pressure and check the tire pressure of all tires including the spare wheel regularly:
- at least once a month
 - when the load changes

- before embarking on a longer journey
 - if operating conditions change, e.g. off-road driving
- ▶ Adjust the tire pressure as necessary.

Driving with tire pressure that is too high or too low can:

- Shorten the service life of the tires.
- Cause increased tire damage.
- Adversely affect handling characteristics and thus driving safety, e.g. due to hydroplaning.

⚠ WARNING Risk of an accident due to insufficient tire pressure

Tires with pressure that is too low can overheat and burst as a result.

In addition, they also suffer from excessive and/or irregular wear, which can significantly impair the braking properties and the handling characteristics.

- ▶ Avoid excessively low tire pressures in all the tires, including the spare wheel.

Tire pressure which is too low can cause:

- Tire defects as a result of overheating
- Impaired handling characteristics
- Irregular wear
- Increased fuel consumption

⚠ WARNING Risk of accident from excessive tire pressure

Tires with excessively high pressure can burst because they are damaged more easily by highway fill, pot holes etc.

In addition, they also suffer from irregular wear, which can significantly impair the braking properties and the handling characteristics.

- ▶ Avoid excessively high tire pressures in all the tires, including the spare wheel.

Excessively high tire pressure can result in:

- Increased braking distance
- Impaired handling characteristics
- Irregular wear

- Impaired driving comfort
- Susceptibility to damage

⚠ WARNING Risk of accident caused by repeated drop in tire pressure

If the tire pressure drops repeatedly, the wheel, valve or tire may be damaged.

Insufficient tire pressure can cause the tires to burst.

- ▶ Inspect the tire for signs of foreign objects.
- ▶ Check whether the wheel or valve has a leak.
- ▶ If you are unable to rectify the damage, contact a qualified specialist workshop.

You can find information on tire pressure for the vehicle's factory-installed tires on the following labels:

- Tire and Loading Information placard on the B-pillar of your vehicle (→ page 303).
- Tire pressure table on the inside of the fuel filler flap (→ page 298).

Observe the maximum tire pressure (→ page 310).

Use a suitable pressure gauge to check the tire pressure. The outer appearance of a tire does not permit any reliable conclusion about the tire pressure.

Vehicles with a tire pressure monitoring system: You can also check the tire pressure using the on-board computer.

Only correct tire pressure when the tires are cold. Conditions for cold tires:

- The vehicle has been parked with the tires out of direct sunlight for at least three hours.
- The vehicle has traveled less than 1 mile (1.6 km).

A rise in the tire temperature of 18 °F (10 °C) increases the tire pressure by approx. 10 kPa (0.1 bar/1.5 psi). Take this into account when checking the tire pressure of warm tires.

The tire pressure recommended for increased load/speed in the tire pressure table can affect the ride comfort.

⚠ WARNING Risk of accident from unsuitable accessories on the tire valves

If you mount unsuitable accessories onto tire valves, the tire valves may be overloaded and malfunction, which can cause tire pressure loss. Tire pressure monitoring systems for retrofitting will cause the tire valve to remain open. This can also result in tire pressure loss.

- ▶ Only screw standard valve caps or valve caps specifically approved by Mercedes-Benz for your vehicle onto the tire valve.

Tire pressure table

The tire pressure table is on the inside of the fuel filler flap.

- ⓘ The data shown in the images is example data.

COLD TIRE PRESSURE			
normal load	300 kPa	300 kPa	
maximum load	350 kPa	420 kPa	
Warm tires up to: + 4 psi			
			A 212 584 00 15

The tire pressure table shows the recommended tire pressure for all factory-approved tires for this vehicle. The recommended tire pressures apply for cold tires under various operating conditions, i.e. loading and/or speed of the vehicle.

LUFTDRUCK PRESSURE PRESSION PRESIÓN			
für kalte Reifen for cold tires des pneus froids de Inflado			
100 kPa = 1 bar			
	kPa	psi	kPa
	psi	kPa	psi
195/55 R16			
215/45 R17			
215/40 R18			
Warme Reifen: Warm tires up to:	+ 30 kPa + 4 psi		Pneus échauffés jusqu'à: Neumáticos calientes hasta:
			A 169 584 50 17

If a tire size precedes a tire pressure, the tire pressure information following is only valid for that tire size.

The load conditions "partially laden" and "fully laden" are defined in the table for different numbers of passengers and amounts of luggage. The actual number of seats may differ from this.

Luftdruck für kalte Reifen			
Tire pressure cold tires			
100 kPa = 1 bar			
Pression des pneus froids			
Presión de inflado			
	kPa	psi	kPa
	psi	kPa	psi
R 18			
R 19			
bis up to hasta	240 km/h	150 mph	Winterreifen: Winter tires: Pneus hiver: Neumáticos de invierno:
Warme Reifen bis: Warm tires up to:	+ 30 kPa + 4 psi		Pneus échauffés jusqu'à: Neumáticos calientes hasta:
			A 212 584 02 17

Some tire pressure tables only show the rim diameter instead of the complete tire size, e. g. **R18**. The rim diameter is part of the tire size and can be found on the tire side wall (→ page 311).

Be sure to also observe the following further related subjects:

- Notes on tire pressure (→ page 297)
- Tire and Loading Information placard (→ page 303)

- Maximum tire pressure (→ page 310)

Checking the tire pressure manually

- ▶ Read the tire pressure for the current operating conditions from the tire and loading information table or the tire pressure table. Observe the notes on tire pressure.
- ▶ Remove the valve cap of the tire to be checked.
- ▶ Press the tire pressure gauge securely onto the valve.
- ▶ Read the tire pressure.
- ▶ If the tire pressure is lower than the recommended value, increase the tire pressure to the recommended value.
- ▶ If the tire pressure is higher than the recommended value, release air. To do so, press down the metal pin in the valve, e.g. using the tip of a pen for example. Then check the tire pressure again using the tire pressure gauge.
- ▶ Screw the valve cap onto the valve.

Further related subjects:

- Notes on tire pressure (→ page 297)
- Tire pressure table (→ page 298)
- Tire and Loading Information placard (→ page 303)

Tire pressure monitoring system

Function of the tire pressure monitoring system

⚠ DANGER Risk of accident due to incorrect tire pressure

Every tire, including the spare (if provided), should be checked when cold at least once a month and inflated to the pressure recommended by the vehicle manufacturer (see Tire and Loading Information placard on the B-pillar on the driver's side or the tire pressure label on the inside of the fuel filler flap of your vehicle). If your vehicle has tires of a different size than the size indicated on the Tire and Loading Information placard or the

tire pressure table, you need to determine the proper tire pressure for those tires.

As an added safety feature, your vehicle has been equipped with a tire pressure monitoring system (TPMS) that illuminates a low tire pressure indicator lamp when one or more of your tires are significantly underinflated. Accordingly, if the low tire pressure indicator lamp lights up, you should stop and check your tires as soon as possible, and inflate them to the proper pressure. Driving on a significantly underinflated tire causes the tire to overheat and can lead to tire failure. Underinflation also increases fuel consumption and reduces tire tread life, and may affect the vehicle's handling and braking ability. Please note that the TPMS is not a substitute for proper tire maintenance, and it is the driver's responsibility to maintain correct tire pressure, even if underinflation has not reached the level to trigger illumination of the TPMS low tire pressure indicator lamp. Your vehicle has also been equipped with a TPMS malfunction indicator to indicate when

the system is not operating properly. The TPMS malfunction indicator is combined with the low tire pressure indicator lamp. When the system detects a malfunction, the indicator lamp will flash for approximately a minute and then remain continuously illuminated. This sequence will continue upon subsequent vehicle start-ups as long as the malfunction exists.

When the malfunction indicator is illuminated, the system may not be able to detect or signal low tire pressure as intended. TPMS malfunctions may occur for a variety of reasons, including the installation of incompatible replacement or alternate tires or wheels on the vehicle that prevent the TPMS from functioning properly.

Always check the TPMS malfunction warning lamp after replacing one or more tires or wheels on your vehicle to ensure that the replacement or alternate tires and wheels allow the TPMS to continue to function properly.

The system checks the tire pressure of the tires mounted on the vehicle by means of a tire pressure sensor.

New tire pressure sensors, e.g. in winter tires, are automatically taught-in the first time they are driven.

The tire pressure appears in the multifunction display (→ page 193).

If there is a substantial pressure loss or if the tire temperature is excessive, a warning will be given:

- Via display messages (→ page 365) .
- Via the  warning lamp in the instrument cluster (→ page 392).

It is the driver's responsibility to set the tire pressure to the recommended cold tire pressure suitable for the operating situation. Set the tire pressure for cold tires using a tire pressure gauge. Note that the correct tire pressure for the current operating situation must first be taught-in to the tire pressure monitoring system.

In most cases, the tire pressure monitoring system will automatically update the new reference

values after you have changed the tire pressure. You can, however, also update the reference values by restarting the tire pressure monitoring system manually (→ page 302).

System limitations

The tire pressure monitoring system does not issue a warning:

- If the tire pressure is set incorrectly.
- If there is a sudden pressure loss caused, for example, by a foreign object penetrating the tire.
- If there is a malfunction caused by another radio signal source.

Be sure to also observe the following further related subjects:

- Notes on tire pressure (→ page 297).

Checking the tire pressure with the tire pressure monitoring system

Requirements

- The ignition is switched on.

On-board computer:

↳ [Service](#) ▶ [Tire Pressure](#)

- ⓘ The spelling may differ in the main menu displayed. Therefore, observe the menu overview for the instrument display in the wide-screen cockpit (→ page 191).

One of the following displays appears:

- Current tire pressure of each wheel:

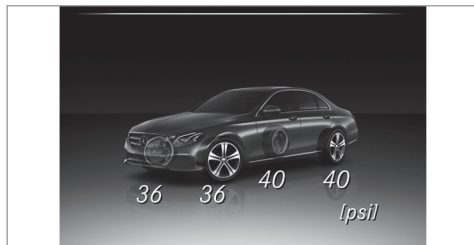

- [Tire pressure will be displayed after driving a few minutes](#)
- [Tire Pressure Monitor Active](#): the teach-in process of the system is not yet complete.

The tire pressures are already being monitored.

- ▶ Compare the tire pressure with the recommended tire pressure for the current operating condition (→ page 298). Observe the notes on tire temperature (→ page 297).

- ⓘ The values displayed in the multifunction display may deviate from those of the tire pressure gauge, as they apply to sea level. At high altitudes, the tire pressure values indicated by the pressure gauge are higher than those shown by the on-board computer. In this case, do not reduce the tire pressure.

Be sure to also observe the following further related subjects:

- [Notes on tire pressure](#) (→ page 297)

Restarting the tire pressure monitoring system

Prerequisites

- The recommended tire pressure is correctly set for the respective operating condition on each of the four wheels (→ page 297).

Restart the tire pressure monitoring system in the following situations:

- The tire pressure has changed.
- The wheels or tires have been changed or newly mounted.

On-board computer:

↳ [Service](#) ▶ [Tire Pressure](#)

- ⓘ The spelling may differ in the main menu displayed. Therefore, observe the menu overview for the instrument display in the wide-screen cockpit (→ page 191).

- ▶ Swipe downwards on the Touch Control on the left-hand side of the steering wheel.

The [Use Current Pressures as New Reference Values](#) message is shown in the multifunction display.

- ▶ Press to confirm the new start.

The [Tire Press. Monitor Restarted](#) message is shown in the multifunction display.

Current warning messages are deleted and the yellow warning lamp goes out.

After you have driven for a few minutes, the system checks whether the current tire pressures are within the specified range. The current tire pressures are then accepted as reference values and monitored.

Be sure to also observe the following further related subjects:

- Notes on tire pressure (→ page 297)

Radio-type approval of the tire pressure monitoring system

Country	Radio equipment approval number
Canada	FCC ID: MRXAG5SP4
USA	FCC ID: MRXMFR IC: 2546A-AG5SP4

Loading the vehicle

Tire and Loading Information placard

⚠ WARNING Risk of accident from overloaded tires

Overloaded tires may overheat and burst as a consequence. Overloaded tires can also impair the steering and handling characteristics and lead to brake failure.

- ▶ Observe the load rating of the tires.
- ▶ The load rating must be at least half the permissible axle load of the vehicle.
- ▶ Never overload the tires by exceeding the maximum load.

The Tire and Loading Information placard is on the B-pillar on the driver's side of the vehicle.

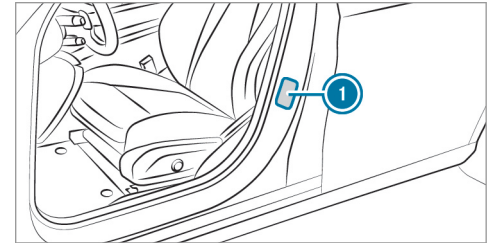

① Tire and Loading Information placard

TIRE AND LOADING INFORMATION		RENSEIGNEMENTS SUR LES PNEUS ET LE CHARGEMENT	
SEATING CAPACITY NOMBRE DE PLACES		TOTAL 7	FRONT AVANT 2
The combined weight of occupants and cargo should never exceed Le poids total des occupants et du chargement ne doit jamais dépasser		XXX kg or XXX lb.*	MI EU 3
TIRE PNEU		COLD TIRE PRESSURE PRESSION DES PNEUS À FROID	SEE OWNER'S MANUAL FOR ADDITIONAL INFORMATION
FRONT AVANT	255/40 ZR18 99Y XL	200 KPA, 29 PSI	VOIR LE MANUEL DE L'USAGER POUR PLUS DE RENSEIGNEMENTS
REAR ARRIÈRE	285/35 ZR18 101Y XL	200 KPA, 29 PSI	
SPARE DE SECOURS	175/55-18 95P	420 KPA, 60 PSI	

i The data shown in the image is example data.

The Tire and Loading Information placard shows:

- Maximum number of seats **2** according to the maximum number of people permitted to travel in the vehicle
- Maximum permissible load **3** comprises the gross weight of all vehicle occupants, load and luggage.

- Recommended tire pressure **1** for cold tires. The recommended tire pressures are valid for the maximum permissible load and up to the maximum permissible vehicle speed.

Please also note:

- Information on permissible weights and loads on the vehicle identification plate (→ page 326).
- Information on tire pressure in the tire pressure table (→ page 298).

Further related subjects:

- Determining the maximum permissible load (→ page 304)
- Notes on tire pressure (→ page 297)

Determining the maximum permissible load

The following steps have been developed as required of all manufacturers under Title 49, Code of U.S. Federal Regulations, Part 575, pursuant to the "National Traffic and Motor Vehicle Safety Act of 1966".

▶ **Step 1:** Locate the statement "The combined weight of occupants and cargo should never exceed XXX kg or XXX lbs." ("The combined weight of occupants and cargo should never exceed XXX kg or XXX lbs.") on your vehicle's tire and loading information table.

▶ **Step 2:** Determine the combined weight of the driver and passengers that will be riding in your vehicle.

▶ **Step 3:** Subtract the combined weight of the driver and passengers from XXX kg or XXX lbs.

▶ **Step 4:** The resulting figure equals the permissible load for cargo and luggage. For example: If "XXX" equals 1400 lbs and there are five occupants in your vehicle with a weight of 150 lbs each, the maximum cargo and luggage load capacity is 650 lbs (1400 - 750 (5 x 150) = 650 lbs).

▶ **Step 5:** Determine the combined weight of luggage and cargo being carried in the vehicle. For safety reasons, this weight may not safely exceed the available cargo and luggage load capacity calculated in step 4.

Even if you have calculated the total load carefully, you should still make sure that the maximum permissible gross mass and the maximum permissible axle load of your vehicle are not exceeded. Details can be found on the vehicle identification plate.

- ▶ Have your loaded vehicle – including driver, occupants and load – weighed on a vehicle weighbridge.
The measured values may not exceed the maximum permissible values stated on the vehicle identification plate.

Further related subjects:

- Calculation example for determining the maximum load (→ page 305)
- Tire and Loading Information placard (→ page 303)
- Tire pressure table (→ page 298)
- Vehicle identification plate (→ page 326)

Calculation example for determining the maximum load

The following table shows examples of how to calculate total and load capacities with varying

seating configurations and different numbers and sizes of occupants. The following examples use a maximum load of 1500 lbs (680 kg). **This is for illustration purposes only.** Make sure you are using the actual load limit for your vehicle stated on your vehicle's Tire and Loading Information placard (→ page 303).

The higher the weight of all the occupants, the smaller the maximum load for luggage.

Step 1

	Example 1	Example 2
Combined maximum weight of occupants and cargo (data from the Tire and Loading Information placard)	1500 lbs (680 kg)	1500 lbs (680 kg)

Step 2

	Example 1	Example 2
Number of people in the vehicle (driver and occupants)	5	1
Distribution of the occupants	Front: 2 Rear: 3	Front: 1
Weight of occupants	Occupant 1: 150 lbs (68 kg) Occupant 2: 180 lbs (82 kg) Occupant 3: 160 lbs (73 kg) Occupant 4: 140 lbs (63 kg) Occupant 5: 120 lbs (54 kg)	Occupant 1: 200 lbs (91 kg)
Total weight of all occupants	750 lbs (340 kg)	200 lbs (91 kg)

Step 3

	Example 1	Example 2
Permissible load (maximum gross vehicle weight rating from the Tire and Loading Information placard minus the gross weight of all occupants)	1500 lbs (680 kg) - 750 lbs (340 kg) = 750 lbs (340 kg)	1500 lbs (680 kg) - 200 lbs (91 kg) = 1300 lbs (589 kg)

Tire labeling

Overview of tire labeling

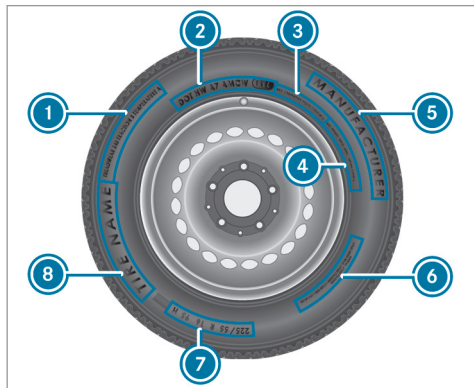

- ① Uniform Tire Quality Grading Standard (→ page 308)
- ② DOT (Department of Transportation), (TIN) Tire Identification Number (→ page 309)
- ③ Maximum tire load (→ page 310)
- ④ Maximum tire pressure (→ page 310)

- ⑤ Manufacturer
- ⑥ Tire characteristics (→ page 311)
- ⑦ Tire size designation, load rating, speed rating and load index (→ page 311)
- ⑧ Tire name
- ⓘ The data shown in the image is example data.

Tire Quality Grading

In accordance with the US Department of Transportation's "Uniform Tire Quality Grading Standards", tire manufacturers are required to grade their tires on the basis of the following three performance factors:

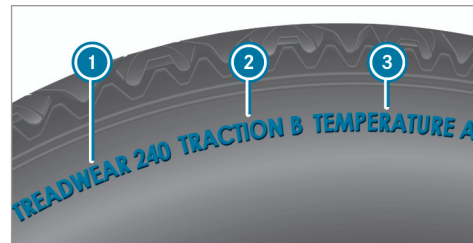

- ① Tread wear grade
- ② Traction grade
- ③ Temperature grade
- ⓘ The data shown in the image is example data.
- ⓘ The classification is not legally stipulated for Canada, but it is generally stated.

Tread wear grade

The tread wear grade is a comparative rating based on the wear rate of the tire when tested under controlled conditions on a specified test track of the US Department of Transportation. For example, a tire graded 150 would wear one

and one-half times as well on the government course as a tire graded 100.

The relative performance of tires depends upon the actual conditions of their use, however, and may depart significantly from the norm due to variations in driving habits, service practices and differences in road characteristics and climate conditions.

Traction grade

⚠ DANGER Risk of accident due to inadequate traction

The traction grade assigned to this tire is based on straight-ahead braking traction tests, and does not include either acceleration, cornering, hydroplaning or peak traction characteristics.

- ▶ Always adapt your driving style and drive at a speed to suit the prevailing traffic and weather conditions.

! NOTE Damage to the drivetrain from wheelspin

- ▶ Avoid wheelspin.

The traction grades – from highest to lowest – are AA, A, B and C. Those grades represent the tire's ability to stop on wet pavement as measured under controlled conditions on specified government test surfaces made of asphalt and concrete.

Temperature grade

⚠ WARNING Risk of accident from tire overheating and tire failure

The temperature grade for this tire is established for a tire that is properly inflated and not overloaded. Excessive speed, underinflation, or excessive loading, either separately or in combination, can cause excessive heat build-up and possible tire failure.

- ▶ Observe the recommended tire pressures and regularly check the tire pres-

sure of all tires including the spare wheel.

- ▶ Adjust the tire pressure as necessary.

The temperature grades are A (the highest), B and C. They represent the tire's resistance to the generation of heat and its ability to dissipate heat when tested under controlled conditions on a specified indoor laboratory test wheel. Sustained high temperatures can cause the material of the tire to degenerate and reduce tire life. Furthermore, excessive temperatures can lead to sudden tire failure. Grade C corresponds to a level of performance which all passenger car tires must meet under the requirements of the US Department of Transportation.

DOT, Tire Identification Number (TIN)

US tire regulations stipulate that every tire manufacturer or retreader must imprint a TIN in or on the side wall of each tire produced.

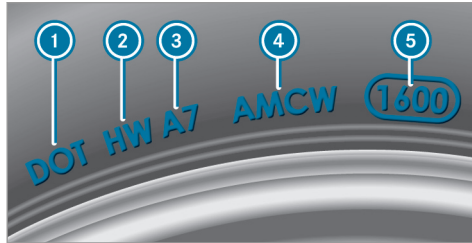

i The data shown in the image is example data.

The TIN is a unique identification number to identify tires and comprises the following:

- **DOT (Department of Transportation):** tire symbol marks **①** indicating that the tire complies with the requirements of the US Department of Transportation.
- **Manufacturer identification code:** manufacturer identification code **②** contains details of the tire manufacturer. New tires have a code with two symbols. Retreaded tires have a code with four symbols. Further information on retreaded tires (→ page 316).

- **Tire size:** identifier **③** describes the tire size.
- **Tire type code:** tire type code **④** can be used by the manufacturer as a code to describe specific characteristics of the tire.
- **Manufacturing date:** manufacturing date **⑤** provides information about the age of a tire. The 1st and 2nd positions represent the calendar week and the 3rd and 4th positions state the year of manufacture (e.g. "3208" represents the 32nd week of 2008).

Information on the maximum tire load



i The data shown in the image is example data.

Maximum tire load **①** is the maximum permissible weight for which the tire is approved.

Do not overload the tires by exceeding the specified load limit. The maximum permissible load can be found on the vehicle's Tire and Loading Information placard on the B-pillar on the driver's side (→ page 303).

Specifications for maximum tire pressure



i The data shown in the image is example data.

Never exceed maximum tire pressure ❶ specified for the tire.

Information on tire characteristics

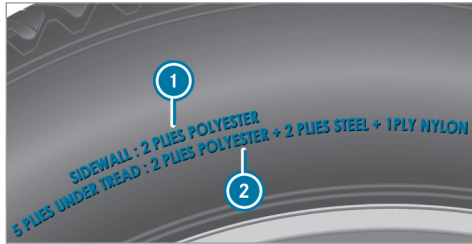

❶ The data shown in the image is example data.

This information describes the type of tire cord and the number of layers in side wall ❶ and under tire tread ❷.

Tire size designation, load-bearing capacity, speed rating and load index

⚠ WARNING Risk of accident due to exceeding the stated tire load rating or the approved speed rating

Exceeding the specified tire load rating or the permissible speed rating may lead to tire damage and to the tires bursting.

- ▶ Therefore, only use tire types and sizes approved for your vehicle model.
- ▶ Observe the tire load rating and speed rating required for your vehicle.

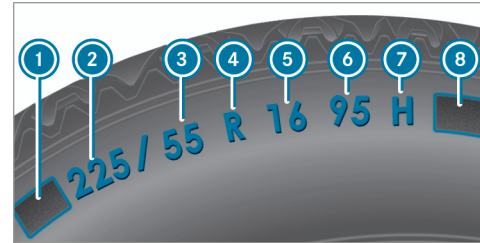

- ❶ Preceding letter
- ❷ Nominal tire width in millimeters
- ❸ Aspect ratio in %
- ❹ Tire code
- ❺ Rim diameter
- ❻ Load-bearing index
- ❼ Speed rating
- ❽ Load index

❶ The data shown in the image is example data.

Information about reading the tire data can be obtained from any qualified specialist workshop.

Preceding letter 1:

- Without: passenger vehicle tires according to European manufacturing standards.
- "P": passenger vehicle tires according to US manufacturing standards.
- "LT": light truck tires according to US manufacturing standards.
- "T": compact emergency spare wheels with high tire pressure that are only designed for temporary use in an emergency.

Aspect ratio 2:

Ratio between tire height and tire width in percent (tire height divided by tire width).

Tire code 4 (tire type):

- "R" radial tire
- "D": bias ply tire
- "B": bias belted tires
- "ZR": radial tire with a maximum speed above 149 mph (240 km/h) (optional)

Rim diameter 5:

The diameter of the bead seat (not the diameter of the rim flange). The rim diameter is specified in inches (in).

Load-bearing index 6

Numerical code that specifies the maximum load-bearing capacity of a tire (e.g. "91" corresponds to 1356 lbs (615 kg)).

The load-bearing capacity of the tire must be at least half the permissible axle load of your vehicle. Do not overload the tires by exceeding the specified load limit.

See also:

- Maximum permissible load on the Tire and Loading Information placard (→ page 303)
- Maximum tire load (→ page 310)
- Load index

Speed rating 7:

Specifies the approved maximum speed of the tire.

- **i** An electronic speed limiter prevents your vehicle from exceeding a speed of 130 mph (210 km/h).

Make sure that your tires have the required speed rating. You can obtain information on the required speed rating from a Mercedes-Benz service center.

Summer tires

Index	Speed rating
Q	up to 100 mph (160 km/h)
R	up to 106 mph (170 km/h)
S	up to 112 mph (180 km/h)
T	up to 118 mph (190 km/h)
H	up to 130 mph (210 km/h)
V	up to 149 mph (240 km/h)
W	up to 168 mph (270 km/h)
Y	up to 186 mph (300 km/h)

Index	Speed rating
ZR...Y ¹	up to 186 mph (300 km/h)
ZR...(..Y) ¹	over 186 mph (300 km/h)
ZR ¹	over 149 mph (240 km/h)

- Specifying the speed rating as the "ZR" index in tire code ④ is optional for tires up to 186 mph (300 km/h).
- If your tire code ④ includes "ZR" and there is no speed rating ⑦, find out what the maximum speed is from the tire manufacturer.
- If load-bearing index ⑥ and speed rating ⑦ are in brackets, the maximum speed rating of your tire is above 186 mph (300 km/h). To find out the maximum speed, ask the tire manufacturer.

¹ "ZR" stated in the tire code.

² Or "M+S"  " for winter tires

All-weather tires and winter tires

Index	Speed rating
Q M+S ²	up to 100 mph (160 km/h)
T M+S ²	up to 118 mph (190 km/h)
H M+S ²	up to 130 mph (210 km/h)
V M+S ²	up to 149 mph (240 km/h)

Winter tires bear the  snowflake symbol and fulfill the requirements of the Rubber Manufacturers Association (RMA) and the Rubber Association of Canada (RAC) regarding traction on snow.

Load index ⑥:

- No specification given: standard load (SL) tire
- "XL" or "Extra Load": extra load tire or reinforced tire
- "Light Load": light load tire

- "C", "D", "E": a load range that depends on the maximum load that the tire can carry at a certain pressure

Definitions for tires and loading

Tire structure and characteristics: describes the number of layers or the number of rubber-coated belts in the tire contact surface and the tire wall. These are made of steel, nylon, polyester and other materials.

Bar: metric unit for tire pressure. 14.5038 pounds per square inch (psi) and 100 kilopascal (kPa) is the equivalent of one bar.

DOT (Department of Transportation): DOT marked tires fulfill the requirements of the US Department of Transportation.

Average weight of the vehicle occupants: the number of vehicle occupants for which the vehicle is designed, multiplied by 150 lb (68 kg).

Uniform Tire Quality Grading Standards: a uniform standard to grade the quality of tires with regard to tread quality, tire traction and temperature characteristics. The quality grading assessment is made by the manufacturer following specifications from the U.S. government. The quality grade of a tire is imprinted on the side wall of the tire.

Recommended tire pressure: the recommended tire pressure is the tire pressure specified for the tires mounted to the vehicle at the factory.

The tire and information table contains the recommended tire pressure for cold tires, the maximum permissible load and the maximum permissible vehicle speed.

The tire pressure table contains the recommended tire pressure for cold tires under various operating conditions, i.e. loading and/or speed of the vehicle.

Increased vehicle weight due to optional equipment: the combined weight of all standard and optional equipment available for the vehicle,

regardless of whether it is actually installed on the vehicle or not.

Rim: the part of the wheel on which the tire is mounted.

GAWR (Gross Axle Weight Rating): the GAWR is the maximum gross axle load. The actual load on an axle must never exceed the gross axle weight rating. The gross axle weight rating can be found on the vehicle identification plate on the B-pillar on the driver's side.

Speed rating: the speed rating is part of the tire identification. It specifies the speed range for which a tire is approved.

GVW (Gross Vehicle Weight): the gross vehicle weight comprises the weight of the vehicle including fuel, tools, the spare wheel, accessories installed, occupants, luggage and the trailer drawbar noseweight, if applicable. The gross vehicle weight must not exceed the gross vehicle weight rating GVWR as specified on the vehicle identification plate on the B-pillar on the driver's side.

GVWR (Gross Vehicle Weight Rating): the GVWR is the maximum permitted gross weight

of the fully laden vehicle (weight of the vehicle including all accessories, occupants, fuel, luggage and the trailer drawbar noseweight if applicable). The gross vehicle weight rating is specified on the vehicle identification plate on the B-pillar on the driver's side.

Maximum weight of the laden vehicle: the maximum weight is the sum of the unladen weight of the vehicle, the weight of the accessories, the maximum load and the weight of optional equipment installed at the factory.

Kilopascal (kPa): metric unit for tire pressure. 6.9 kPa corresponds to 1 psi. Another unit for tire pressure is bar. 100 kilopascal (kPa) equals 1 bar.

Load index: in addition to the load-bearing index, the load index may also be imprinted on the side wall of the tire. This specifies the load-bearing capacity of the tire more precisely.

Curb weight: the weight of a vehicle with standard equipment including the maximum capacity of fuel, oil and coolant. It also includes the air conditioning system and optional equipment if

these are installed on the vehicle, but does not include passengers or luggage.

Maximum tire load: the maximum tire load is the maximum permissible weight in kilograms or lbs for which a tire is approved.

Maximum permissible tire pressure: maximum permissible tire pressure for one tire.

Maximum load on one tire: maximum load on one tire. This is calculated by dividing the maximum axle load of one axle by two.

PSI (pounds per square inch): standard unit of measurement for tire pressure.

Aspect ratio: ratio between tire height and tire width in percent.

Tire pressure: pressure inside the tire applying an outward force to every square inch of the tire. The tire pressure is specified in pounds per square inch (psi), in kilopascals (kPa) or in bar. The tire pressure should only be corrected when the tires are cold.

Cold tire pressure: the tires are cold when the vehicle has been parked for at least 3 hours

without direct sunlight on the tires or the vehicle has been driven for less than 1 mile (1.6 km).

Tire contact surface: the part of the tire that comes into contact with the road.

Tire bead: the purpose of the tire bead is to ensure that the tire sits securely on the wheel rim. There are several steel wires in the bead to prevent the tire from coming loose from the wheel rim.

Side wall: the part of the tire between the tread and the tire bead.

Weight of optional equipment: the combined weight of the optional equipment weighing more than the replaced standard parts and more than 5 lbs (2.3 kg). This optional equipment, such as high-performance brakes, level control system, a roof luggage rack or high-performance batteries, is not included in the curb weight and the weight of the accessories.

TIN (Tire Identification Number): a unique identification number which can be used by a tire manufacturer to identify tires, for example, in a product recall, and thus identify the purchasers. The TIN is made up of the manufactur-

er's identity code, tire size, tire type code and the manufacturing date.

Load-bearing index: the load-bearing index (also load index) is a code that contains the maximum load-bearing capacity of a tire.

Traction: traction is the grip resulting from friction between the tires and the road surface.

Wear indicator: narrow bars (tread wear bars) that are distributed over the tire contact surface. If the tire tread is level with the bars, the wear limit of 1/16 in (1.6 mm) has been reached.

Distribution of vehicle occupants: distribution of vehicle occupants over designated seat positions in a vehicle.

Maximum permissible payload weight: nominal load and luggage load plus 150 lb (68 kg) multiplied by the number of seats in the vehicle.

Changing a wheel

Notes on selecting, installing and replacing tires

You can ask for information regarding permitted wheel/tire combinations at an authorized Mercedes-Benz service center.

⚠ WARNING Risk of accident due to incorrect dimensions of wheels and tires

If wheels and tires of the wrong size are installed, the wheel brakes or wheel suspension components may be damaged.

- ▶ Always replace wheels and tires with those that fulfill the specifications of the original part.

When replacing wheels, make sure to fit the correct:

- Designation
- Model

When replacing tires, make sure to install the correct:

- Designation
- Manufacturer
- Model

⚠ WARNING Risk of accident due to exceeding the stated tire load rating or the approved speed rating

Exceeding the specified tire load rating or the permissible speed rating may lead to tire damage and to the tires bursting.

- ▶ Therefore, only use tire types and sizes approved for your vehicle model.
- ▶ Observe the tire load rating and speed rating required for your vehicle.

! **NOTE** Damage to vehicle and tires due to non-approved tire types and sizes

For safety reasons, only use wheels, tires and accessories which have been approved for your vehicle by Mercedes-Benz.

These tires have been specially adapted for use with the control systems, e.g. ABS or ESP®, and are marked as follows:

- MO = Mercedes-Benz Original
- MOE = Mercedes-Benz Original Extended (run-flat tires only for certain wheels)
- MO1 = Mercedes-Benz Original (only certain AMG tires)

Certain characteristics, e.g. handling, vehicle noise emissions or fuel consumption, may otherwise be adversely affected. In addition, when driving with a load, tire dimension variations could cause the tires to come into contact with the body and axle components. This could result in damage to the tires or the vehicle.

Only use tires, wheels or accessories tested and approved by Mercedes-Benz.

! **NOTE** Risk to driving safety from retreaded tires

Retreaded tires are neither tested nor recommended by Mercedes-Benz, since previous damage cannot always be detected on retreaded tires.

For this reason driving safety cannot be guaranteed.

- ▶ Do not use used tires if you have no information about their previous usage.

! **NOTE** Possible damage to wheels or tires when driving over obstacles

Large wheels have a lower tire section width. The lower the tire section width, the greater is the risk of damage to wheels or tires when driving over obstacles.

- ▶ Avoid obstacles or drive particularly carefully.

! **NOTE** Damage to electronic component parts from the use of tire-mounting tools

Vehicles with a tire pressure monitoring system: Electronic component parts are located in the wheel. Tire-mounting tools should not be used in the area of the valve.

This could otherwise damage the electronic component parts.

- ▶ Have the tires changed at a qualified specialist workshop only.

! **NOTE** Damage to summer tires at low ambient temperatures

Using summer tires at very low ambient temperatures can cause cracks to form, thereby damaging the tires permanently.

- ▶ At temperatures below 45 °F (7 °C) use M+S tires.

Accessory parts that are not approved for your vehicle by Mercedes-Benz or that are not being used correctly can impair operating safety.

Before purchasing and using non-approved accessories, visit a qualified specialist workshop and enquire about:

- Suitability
- Legal stipulations
- Factory recommendations

Observe the following when selecting, installing and replacing tires:

- Only use tires and wheels of the same type (summer tires, winter tires, MOExtended tires) and the same make.
 - Only install wheels of the same size on one axle (left and right).
- It is only permissible to install a different wheel size in the event of a flat tire in order to drive to the specialist workshop.
- Only install tires of the correct size onto the wheels.

• **Vehicles with a tire pressure monitoring system:** All installed wheels must be equipped with functioning sensors for the tire pressure monitoring system.

- At temperatures below 45 °F (7 °C), use winter tires or all-season tires marked M+S for all wheels.

Winter tires bearing the  snowflake symbol in addition to the M+S marking provide the best possible grip in wintry road conditions.

- For M+S tires, only use tires with the same tread.
- Observe the maximum permissible speed for the M+S tires installed.

If this is below the vehicle's maximum speed, this must be indicated in an appropriate label in the driver's field of vision.

- Break in new tires at moderate speeds for the first 60 miles (100 km).
- Replace the tires after six years at the latest, regardless of wear.
- **When replacing with tires that do not feature run-flat characteristics:** vehicles with MOExtended tires are not equipped with a TIREFIT kit at the factory. Equip the vehicle with a TIREFIT kit after replacing with tires

that do not feature run-flat characteristics, e.g. winter tires.

For more information on wheels and tires, contact a qualified specialist workshop.

Be sure to also observe the following further related subjects:

- Notes on tire pressure (→ page 297)
- Tire and Loading Information placard (→ page 303)
- Tire pressure table (→ page 298)

Notes on interchanging wheels

 **WARNING** Risk of injury through different wheel sizes

Interchanging the front and rear wheels if the wheels or tires have different dimensions may severely impair the driving characteristics.

The wheel brakes or wheel suspension components may also be damaged.

 Rotate front and rear wheels only if the wheels and tires are of the same dimensions.

The wear patterns on the front and rear wheels differ:

- Front wheels wear more on the shoulder of the tire.
- Rear wheels wear more in the center of the tire.

On vehicles that have the same size front and rear wheels, rotate the wheels according to the intervals in the tire manufacturer's warranty book in your vehicle documents. If this is not available, rotate the tires every 3000 to 6000 miles (5000 to 10000 km), depending on the wear. Ensure that the direction of rotation is maintained.

It is imperative to observe the instructions and safety notes on changing a wheel when doing so.

Notes on storing wheels

- After removing wheels, store them in a cool, dry and preferably dark place.
- Protect the tires from contact with oil, grease or fuel.

Preparing the vehicle for a wheel change

Prerequisites

- The required tire-change tool kit is available. If your vehicle is not equipped with the tire-change tool kit, consult a qualified specialist workshop to find out about suitable tools.
 - The vehicle is not on a slope.
 - The vehicle is on solid, non-slippery and level ground.
- ▶ Apply the electric parking brake manually.
- ▶ Move the front wheels to the straight-ahead position.
- ▶ **Vehicles with automatic transmission:** shift into position **P**.

- ▶ **Vehicles with AIR BODY CONTROL:** set the normal vehicle level (→ page 169).
- ▶ Switch off the engine.
- ▶ Make sure that the engine cannot be started.
- ▶ Place chocks or other suitable items under the front and rear of the wheel that is diagonally opposite the wheel you wish to change.
- ▶ Remove the hub caps if necessary (→ page 319).
- ▶ Raise the vehicle (→ page 320).

Removing and mounting hub caps

Prerequisites

- ▶ The vehicle is prepared for a wheel change (→ page 319).

Plastic hub cap

- ▶ **To remove:** turn the center cover of the hub cap counter-clockwise and remove the hub cap.
- ▶ **To mount:** make sure that the center cover of the hub cap is turned counter-clockwise.

- ▶ Position the hub cap and turn the center cover clockwise until the hub cap engages physically and audibly.

Aluminum hub cap

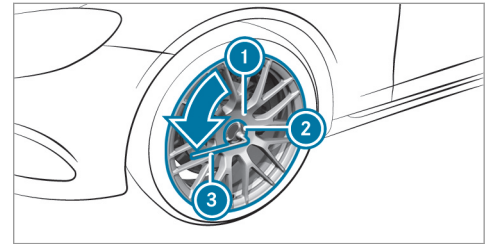

- ▶ **To remove:** position socket **2** on hub cap **1**.
- i** The socket can be found in the vehicle tool kit.
- ▶ Position wheel wrench **3** on socket **2**.
- ▶ Using wheel wrench **3**, turn hub cap **1** counter-clockwise and remove it.

- ▶ **To mount:** position hub cap ① and turn until it is completely flush with the wheel.
- ▶ Position socket ② on hub cap ①.
- ▶ Attach wheel wrench ③ to socket ② and tighten the hub cap clockwise.
- ▶ **Specified tightening torque:** 18 lb-ft (25 Nm).
- ▶ Raise the vehicle (→ page 320).

Raising the vehicle when changing a wheel

Prerequisites

- There are no persons in the vehicle.
- The vehicle is prepared for a wheel change (→ page 319).
- The hub caps have been removed (→ page 319).

Important notes on using the jack:

- Only use the vehicle-specific jack that has been tested and approved by Mercedes-Benz to raise the vehicle.
- The jack is only designed for raising and holding the vehicle for a short time while a

wheel is being changed and not for maintenance work under the vehicle.

- The jack must be placed on a firm, flat and non-slip surface. If necessary, use a large, load-bearing, non-slip underlay.
- The base of the jack must be positioned vertically under the jack support point.

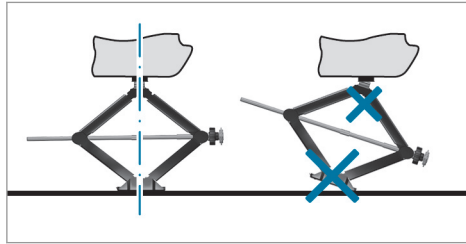

Rules of conduct when the vehicle is raised:

- Never place your hands or feet under the vehicle.
- Do not lie under the vehicle.
- Do not start the engine and do not release the parking brake.

- Do not open or close any doors or the trunk lid.

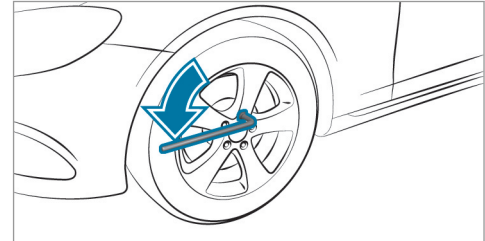

- ▶ Using the wheel wrench, loosen the wheel bolts on the wheel you wish to change by about one full turn. Do not unscrew the bolts completely.

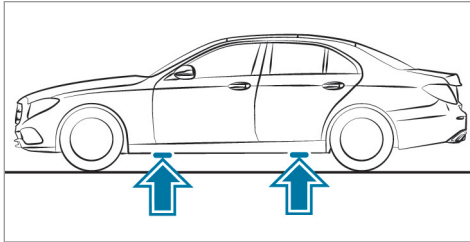

Position of jack support points

⚠ WARNING Risk of injury from incorrect positioning of the jack

If you do not position the jack correctly at the appropriate jacking point of the vehicle, the jack could tip with the vehicle raised.

- ▶ Only position the jack at the appropriate jacking point of the vehicle. The base of the jack must be positioned vertically under the jacking point of the vehicle.

! **NOTE** Vehicle damage from the jack

If you do not position the jack correctly at the appropriate jack support point of the vehicle, the jack could tip over with the vehicle raised.

- ▶ The jack is designed exclusively for jacking up the vehicle at the jack support points.

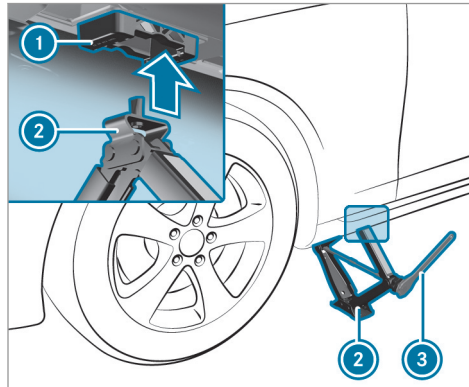

- ▶ Position jack (2) at jack support point (1).
- ▶ Turn crank (3) clockwise until jack (2) sits completely on jack support point (1) and the base of the jack lies evenly on the ground.
- ▶ Turn crank (3) until the tire is raised a maximum of 1.2 in (3 cm) from the ground.
- ▶ Loosen and remove the wheel (→ page 321).

Removing a wheel

Prerequisites

- The vehicle is raised (→ page 320).

When changing a wheel, avoid applying any force to the brake disks, since this could impair the level of comfort when braking.

! **NOTE** Damage to threading from dirt on wheel bolts

- ▶ Do not place wheel bolts in sand or on a dirty surface.

- ▶ Unscrew the uppermost wheel bolt completely.

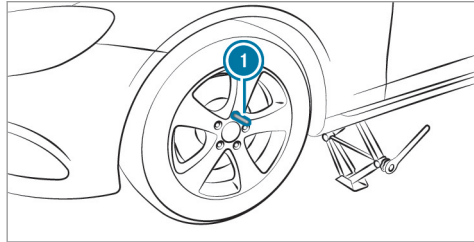

- ▶ Screw centering pin ① into the thread instead of the wheel bolt.
- ▶ Unscrew the remaining wheel bolts fully.
- ▶ Remove the wheel.
- ▶ Mount the new wheel (→ page 322).

Mounting a new wheel

Prerequisites

- The wheel is removed (→ page 321).

⚠ WARNING Risk of accident from losing a wheel

Oiled, greased or damaged wheel bolts or wheel hub threads can cause the wheel bolts to come loose.

As a result, you could lose a wheel while driving.

- ▶ Never oil or grease the wheel bolts.
- ▶ In the event of damage to the threads, contact a qualified specialist workshop immediately.
- ▶ Have the damaged wheel bolts or damaged hub threads replaced.
- ▶ Do not drive any further.

- ▶ Observe the information on selecting tires (→ page 316).

On tires with a specified direction of rotation, an arrow on the sidewall indicates the tire's direction of rotation. Observe the direction of rotation when fitting the tire.

- ▶ Slide the wheel to be mounted onto the centering pin and push it on.

⚠ WARNING Risk of injury from tightening wheel bolts and nuts

If you tighten the wheel bolts or wheel nuts when the vehicle is raised, the jack could tip.

- ▶ Only tighten wheel bolts or wheel nuts when the vehicle is on the ground.

- ▶ For safety reasons, Mercedes-Benz recommends that you only use wheel bolts which have been approved for Mercedes-Benz vehicles, as well as for the wheel in question.

! **NOTE** Damage to paintwork of the wheel rim when screwing on the first wheel bolt

If the wheel has too much play when screwing in the first wheel bolt, the wheel rim paint can be damaged.

- ▶ Press the wheel firmly against the wheel hub when screwing on the first wheel bolt.

- ▶ Screw in the wheel bolts and tighten slightly.
- ▶ Unscrew the centering pin.
- ▶ Screw in the last wheel bolt and tighten slightly.
- ▶ Lower the vehicle(→ page 323).

Lowering the vehicle after a wheel change

Prerequisites

- The new wheel has been mounted (→ page 322).
- ▶ **To lower the vehicle:** turn the crank of the jack counter-clockwise.

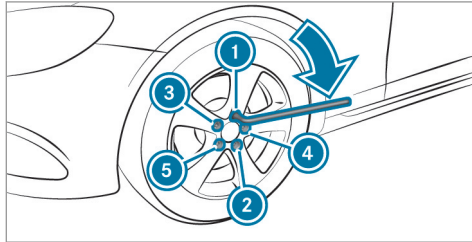

- ▶ Tighten the wheel bolts evenly in a crosswise pattern in the sequence indicated (1 to 5).
Specified tightening torque: 111 lb-ft (150 Nm).

⚠ WARNING Risk of accident due to incorrect tightening torque

The wheels could come loose if the wheel bolts or wheel nuts are not tightened to the prescribed tightening torque.

- ▶ Have the tightening torque checked immediately at a qualified specialist workshop after changing a wheel.

- ▶ Check the tire pressure of the newly mounted wheel and adjust accordingly.
- ▶ **Vehicles with a tire pressure monitoring system:** restart the tire pressure monitoring system (→ page 302).

Be sure to also observe the following further related subjects:

- Notes on tire pressure (→ page 297)

Notes on technical data

The data stated only applies to vehicles with standard equipment. You can obtain further information from a Mercedes-Benz service center.

Vehicle electronics

Notes on installing two-way radios

⚠ WARNING Risk of accident from incorrectly carried out work on the RF transmitter

The electromagnetic radiation from RF transmitters can interfere with the vehicle electronics if RF transmitters are manipulated or retrofitted incorrectly.

This could jeopardize the operating safety of the vehicle.

- ▶ You should have all work on electrical and electronic components carried out at a qualified specialist workshop.

⚠ WARNING Risk of accident from incorrect operation of the RF transmitter

If you operate RF transmitters incorrectly in the vehicle, the electromagnetic radiation could interfere with the on-board electronics, e.g.:

- if the RF transmitter is not connected to an exterior antenna
- if the exterior antenna is not correctly mounted or is not a low-reflection type.

This could jeopardize the operating safety of the vehicle.

- ▶ Have the low-reflection exterior antenna installed at a qualified specialist workshop.
- ▶ When operating RF transmitters in the vehicle, always connect them to the low-reflection exterior antenna.

! NOTE Invalidation of the operating permit due to failure to comply with the instructions for installation and use

The operating permit may be invalidated if the instructions for installation and use of RF transmitters are not observed.

- ▶ Only use approved frequency bands.
- ▶ Observe the maximum permissible output power in these frequency bands.
- ▶ Only use approved antenna positions.

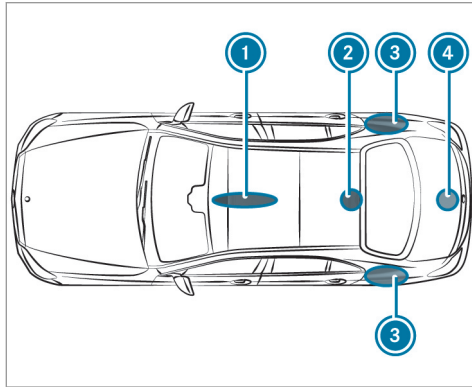

- ① Front roof area
- ② Rear roof area
- ③ Rear fender
- ④ Trunk lid

On vehicles with panoramic sliding sunroof, installing an antenna to the front or rear roof area is not permitted.

On the rear fenders, it is recommended that you position the antenna on the side of the vehicle closest to the center of the road.

Use Technical Specification ISO/TS 21609 (Road Vehicles – EMC guidelines for installation of aftermarket radio frequency transmitting equipment) when retrofitting RF (radio frequency) transmitters. Comply with the legal requirements for detachable parts.

If your vehicle has a pre-installation for two-way radio equipment, use the power supply or antenna connections intended for use with the basic wiring. Be sure to observe the manufacturer's Supplements when installing.

Frequency band	Maximum transmission output
Short wave 3 - 54 MHz	100 W
4 m band 74 - 88 MHz	30 W

Frequency band	Maximum transmission output
2 m band 144 - 174 MHz	50 W
Trunked radio system/Tetra 380 - 460 MHz	10 W
70 cm band 400 - 460 MHz	35 W
Mobile communications (2G/3G/4G)	10 W

The following can be used in the vehicle without restrictions:

- RF transmitter with a maximum transmission output of up to 100 mW
- RF transmitters with transmitter frequencies in the 380 - 410 MHz frequency band and a maximum transmission output of up to 2 W (trunked radio system/Tetra)
- Mobile phones (2G/3G/4G)

There are no restrictions when positioning the antenna on the outside of the vehicle for the following frequency bands:

- Trunked radio system/Tetra
- 70 cm band
- 2G/3G/4G

Vehicle identification plate, VIN and engine number

Vehicle identification plate

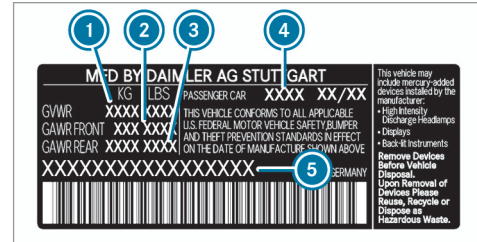
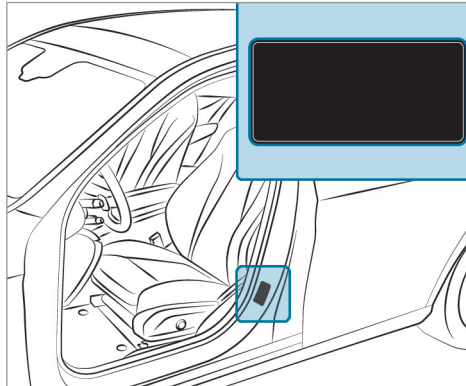

Vehicle identification plate (USA only)

- ① Permissible gross mass
- ② Permissible front axle load
- ③ Permissible rear axle load
- ④ Paint code
- ⑤ VIN (vehicle identification number)



Vehicle identification plate (Canada only)

- ① Permissible gross mass
- ② Permissible front axle load
- ③ Permissible rear axle load
- ④ Paint code
- ⑤ VIN (vehicle identification number)

The maximum permissible gross vehicle weight is made up of the vehicle weight, all vehicle occupants, the fuel and the load. The maximum permissible axle load is the maximum weight that can be carried by one axle (front or rear axle).

Never exceed the maximum permissible gross vehicle weight or the maximum permissible axle load for the front or rear axle.

VIN in front of the right-hand front seat

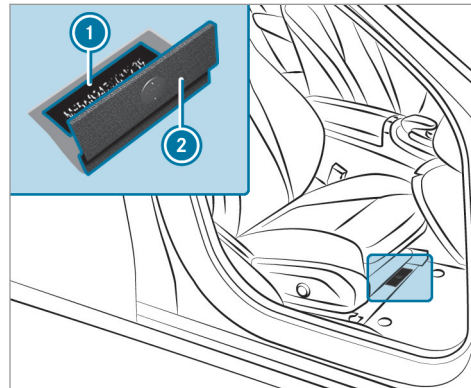

- ① VIN (vehicle identification number)
- ② Floor covering

Additional plates

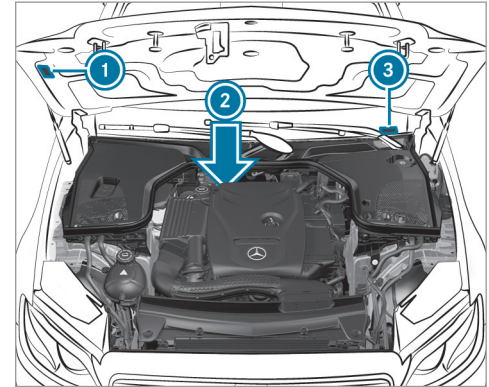

- ① Plate with information about emissions testing, including confirmation of emissions guidelines at the U.S. federal level as well as for California
- ② Engine number stamped into the crankcase
- ③ VIN (vehicle identification number)

Operating fluids

Notes on operating fluids

⚠ WARNING Risk of injury from operating fluids harmful to your health

Operating fluids may be poisonous and harmful to your health.

- ▶ Observe the text on the original containers when using, storing or disposing of operating fluids.
- ▶ Always store operating fluids sealed in their original containers.
- ▶ Always keep children away from operating fluids.

! ENVIRONMENTAL NOTE Environmental pollution caused by environmentally irresponsible disposal

- ▶ Dispose of operating fluids in an environmentally responsible manner.

Operating fluids include the following:

- fuels
- lubricants
- coolant
- brake fluid
- windshield washer fluid
- climate control system refrigerant

Only use products recommended by Mercedes-Benz. Damage which is caused by the use of vehicle products which have not been recommended is not covered by the Mercedes-Benz guarantee, warranty or goodwill gestures.

You can identify operating fluids approved by Mercedes-Benz by the following inscriptions on the container:

- MB-Freigabe (e.g. MB-Freigabe 229.51)
- MB-Approval (e.g. MB-Approval 229.51)

Further information on approved operating fluids

- from the Mercedes-Benz Specification for Operating Fluids at <http://bevo.mercedes-benz.com> (by entering the designation)

- at a qualified specialist workshop

⚠ WARNING Risk of fire and explosion caused by fuel

Fuels are highly inflammable.

- ▶ You must avoid fire, open flames, creating sparks and smoking.
- ▶ Before refueling, switch off the engine and, if installed in your vehicle, the stationary heater.

⚠ WARNING Risk of injury from fuel

Fuels are poisonous and harmful to your health

- ▶ Do not swallow fuel or let it come into contact with skin, eyes or clothing.
- ▶ Do not inhale fuel vapors.
- ▶ Keep children away from fuel.

If you or other people come into contact with fuel, observe the following:

- ▶ Immediately rinse fuel off your skin with soap and water.
- ▶ If fuel comes into contact with your eyes, immediately rinse them thoroughly with clean water. Seek medical attention immediately.
- ▶ If you swallow fuel, seek medical attention immediately. Do not induce vomiting.
- ▶ Change immediately out of clothing that has come into contact with fuel.

Fuel

Information on fuel grades for vehicles with a gasoline engine

Observe the notes on operating fluids (→ page 328).

! **NOTE** Damage caused by the wrong fuel

Even small amounts of the wrong fuel could result in damage to the fuel system, the engine and the emission control system.

- ▶ Only refuel with low-sulfur premium grade fuel.

This fuel may contain up to 10 % ethanol. Your vehicle is suitable for use with E10 fuel.

Do not refuel using:

- Diesel
- E15, E85, E100
- Gasoline containing methanol (M15, M30, M85, M100)
- Gasoline with additives containing metal

If you accidentally refuel with the wrong fuel:

- ▶ Do not switch the ignition on.
- ▶ Consult a qualified specialist workshop.

If the available fuel is not sufficiently low in sulfur, this can produce unpleasant odors.

Only refuel with fuel, that has at least the octane number specified in the information table in the fuel filler flap (→ page 138). This may reduce engine output and increase fuel consumption.

If you want maximum engine output: only refuel with unleaded premium grade gasoline with at least 95 RON.

Never refuel using gasoline with a lower RON.

! **NOTE** Premature wear caused by unleaded regular gasoline

Unleaded regular gasoline can cause the engine to wear more quickly and impair longevity and performance.

If unleaded premium grade gasoline is unavailable and you have to refuel using unleaded regular gasoline:

- ▶ Only fill the fuel tank to half full with unleaded regular gasoline and refill as soon as possible with unleaded premium grade gasoline.
- ▶ Do not drive at the maximum speed.
- ▶ Avoid sudden acceleration and engine speeds over 3,000 rpm.

Further information on fuel:

- At a gas station

- At a qualified specialist workshop
- **USA only:** At <http://www.mbusa.com>

Information on additives in gasoline

Observe the notes on operating fluids (→ page 328).

! **NOTE** Damage caused by non-approved additives

Even small amounts of the wrong additive may lead to malfunctions occurring.

- ▶ Only add cleaning additives recommended by Mercedes-Benz to the fuel.

Mercedes-Benz recommends that you use fuel brands that have additives.

The fuel grade available in some countries may not be sufficient. Residue could build up in the fuel injection system as a result. In this case, in consultation with an authorized Mercedes-Benz service center, the fuel may be mixed with the cleaning additive recommended by Mercedes-Benz. Always observe the notes and mixing ratios specified on the container.

Notes on fuel consumption

! **ENVIRONMENTAL NOTE** Increased CO₂ emissions caused by increased fuel consumption

The CO₂ emissions of your vehicle depend directly on the fuel consumption.

- ▶ You can minimize CO₂ emissions by driving carefully and having your vehicle serviced regularly.

Tank capacity and reserve fuel level

Model	Total capacity
All models	17.4 US gal (66.0 l)
Model	Of which reserve
All models	1.8 US gal (7.0 l)

Notes on engine oil

Observe the notes on operating fluids (→ page 328).



! **NOTE** Engine damage caused by an incorrect oil filter, incorrect oil or additives

- ▶ Do not use engine oils or oil filters other than those which meet the specifications necessary for the prescribed service intervals.
- ▶ Do not alter the engine oil or oil filter in order to achieve longer change intervals than prescribed.
- ▶ Do not use additives.
- ▶ Have the engine oil changed after the prescribed intervals.

Further information on engine oils and oil filters:

- In the Mercedes-Benz Specifications for Operating Fluids at <http://bevo.mercedes-benz.com> (by entering the designation)
- At a qualified specialist workshop

Mercedes-Benz recommends that you have the oil change carried out at a qualified specialist workshop.

Gasoline engines	MB-Freigabe or MB-Approval
All models	229.5, 229.6

If the engine oils listed in the table are not available, you may add a maximum of 1.1 US qt (1.0 l) of the following engine oils once:

- **Gasoline engines:** MB-FreigabeOr MB-Approval 229.1, 229.3 or ACEA A3

Filling capacities

The following values refer to an oil change including the oil filter.

Model	Capacity
E 300	7.4 US qt (7.0 l)
All other models	6.9 US qt (6.5 l)

Notes on brake fluid

Observe the notes on operating fluids (→ page 328).

⚠ WARNING Risk of an accident due to vapor pockets forming in the brake system

The brake fluid constantly absorbs moisture from the air. This lowers the boiling point of the brake fluid. If the boiling point is too low, vapor pockets may form in the brake system when the brakes are applied hard.

This causes the braking effect to be impaired.

- ▶ Have the brake fluid renewed at the specified intervals.

Have the brake fluid regularly changed at a qualified specialist workshop.

Only use brake fluid approved by Mercedes-Benz according to MB-Freigabe or MB-Approval 331.0.

Further information on brake fluid:

- In the Mercedes-Benz Specifications for Operating Fluids at <http://bevo.mercedes-benz.com>
- At a qualified specialist workshop

Notes on coolant

Observe the notes on operating fluids (→ page 328).

⚠ WARNING - Risk of fire and injury from antifreeze

If antifreeze comes into contact with hot component parts in the engine compartment, it may ignite.

- ▶ Allow the engine to cool down before adding antifreeze.

- ▶ Make sure that no antifreeze spills out next to the filler opening.
- ▶ Thoroughly clean off any antifreeze from component parts before starting the vehicle.

! **NOTE** Damage caused by incorrect coolant

- ▶ Only add coolant that has been pre-mixed with the required antifreeze protection.

Further information on coolant

- In the Mercedes-Benz Specifications for Operating Fluids 310.1, e.g. online at <http://bevo.mercedes-benz.com>
- At a qualified specialist workshop

! **NOTE** Overheating at high outside temperatures

If an inappropriate coolant is used, the engine cooling system is not sufficiently pro-

tected against overheating and corrosion at high outside temperatures.

- ▶ Always use an appropriate coolant.

Have the coolant regularly changed at a qualified specialist workshop.

The proportion of corrosion inhibitor/antifreeze concentrate in the engine cooling system should be:

- A minimum of 50% (antifreeze protection down to approximately -35 °F (-37 °C))
- A maximum of 55% (antifreeze protection down to -49 °F (-45 °C))

Filling capacities

Model	Filling capacity
All models	12.7 US qt (12.0 l)

Notes on windshield washer fluid

Observe the notes on operating fluids (→ page 328).

! **WARNING** - Risk of fire and injury from windshield washer concentrate

Windshield washer concentrate is highly flammable. It could ignite if it comes into contact with hot engine component parts or the exhaust system.

- ▶ Make sure that no windshield washer concentrate spills out next to the filler opening.

! **NOTE** Damage to the exterior lighting due to unsuitable windshield washer fluid

Unsuitable windshield washer fluid may damage the plastic surface of the exterior lighting.

- ▶ Only use windshield washer fluid that is also suitable for plastic surfaces, e.g. MB SummerFit or MB WinterFit.

! **NOTE** Blocked spray nozzles caused by mixing windshield washer fluids

▶ Do not mix MB SummerFit and MB WinterFit with other windshield washer fluids.

Do not use distilled or de-ionized water as the fill level sensor may be triggered erroneously.

Recommended windshield washer fluid

- Above freezing point: e.g. MB SummerFit
- Below freezing point: e.g. MB WinterFit

For the correct mixing ratio refer to the information on the antifreeze reservoir.

Mix the washer fluid with the windshield washer fluid all year round.

Notes on refrigerants

Observe the notes on operating fluids (→ page 328).

! **NOTE** Damage due to incorrect refrigerant

If a non-approved refrigerant is used, the climate control system may be damaged.

▶ Only use the refrigerant R-134a

! **NOTE** Damage to the climate control system due to incorrect refrigerant compressor oil

▶ Only use refrigerant compressor oil that has been approved by Mercedes-Benz.

▶ Do not mix the approved refrigerant compressor oil with a different refrigerant compressor oil.

Work on the climate control system may only be carried out by a qualified specialist workshop. All applicable regulations, as well as SAE standard J639, must be adhered to.

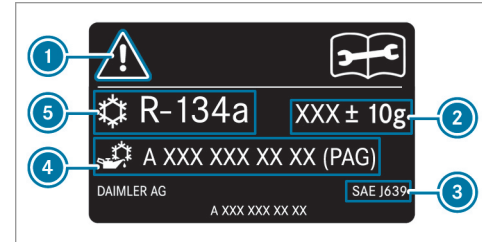

- ① Warning symbols
- ② Refrigerant filling capacity
- ③ Applicable standards
- ④ PAG oil part number
- ⑤ Type of refrigerant

Warning symbols ① advise you about:

- Possible dangers
- Having service work carried out at a qualified specialist workshop

Filling capacities

Model	Refrigerant
All models	22.2 ± 0.4 oz (630 ± 10 g)
Model	PAG oil
All models	2.8 ± 0.4 oz (80 ± 10 g)

Vehicle data

Vehicle dimensions

The heights specified may vary as a result of the:

- Tires
- Load
- Condition of the suspension
- Optional equipment

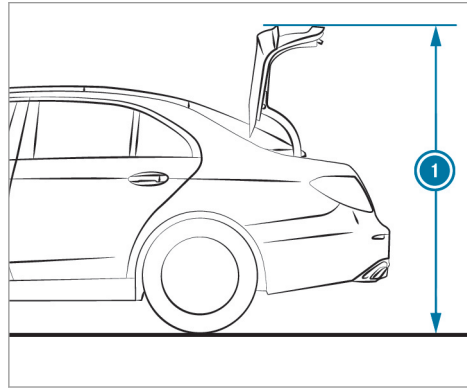

Model	① Opening height
E 300	72.4 in (1839 mm)
E 300 4MATIC	72.7 in (1846 mm)

All models	
Vehicle length	193.8 in (4923 mm)
Vehicle width including outside mirrors	81.3 in (2065 mm)
Wheelbase	115.7 in (2939 mm)
Model	Vehicle height
E 300	57.8 in (1468 mm)
All other models	58.0 in (1474 mm)
Model	Turning radius
E 300	38.1 ft (11.60 m)
All other models	39.0 ft (11.90 m)

Weight and loads

Please note that for the specified vehicle data:

- Items of optional equipment increase the curb weight and reduce the maximum payload.

Missing values were not available at time of going to print.

All models	
Maximum roof load	220 lb (100 kg)
Maximum trunk load	

Display messages

Introduction

Notes on display messages

Display messages appear in the multifunction display.

Display messages with graphic symbols are simplified in the Operator's Manual and may differ from the symbols in the multifunction display. The multifunction display shows high-priority display messages in red. Certain display messages are accompanied by a warning tone.

Please respond in accordance with the display messages and follow the additional notes in this Operator's Manual.

Low-priority display messages can be hidden by pressing the  button or the left-hand side of Touch Control. The display messages are then stored in the message memory. Rectify the cause of a display message as quickly as possible.

High-priority display messages cannot be hidden. The multifunction display shows these display messages continuously until the cause for the display message has been rectified.

Calling up stored display messages

On-board computer:

 [Service](#)  [Error_Messages_Counter messagesUnit](#)

If there are no display messages, the [No Messages](#) display appears in the multifunction display.

▶ Scroll through the display messages by swiping upwards or downwards on Touch Control on the left-hand side of the steering wheel.

▶ **To exit the message memory:** press the  button.

Safety systems

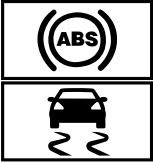

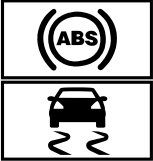
Display messages	Possible causes/consequences and Solutions
 <p data-bbox="195 459 458 508">Currently Unavailable See Operator's Manual</p>	<p data-bbox="526 282 1258 342">* ABS and ESP[®] are temporarily unavailable. Other driving systems and driving safety systems may also malfunction.</p> <div data-bbox="547 360 1700 609" style="border: 1px solid gray; padding: 5px;"> <p data-bbox="565 370 1240 397">⚠ WARNING Risk of skidding if ABS and ESP[®] are malfunctioning</p> <p data-bbox="565 415 1641 464">If ABS and ESP[®] are malfunctioning, the wheels could lock when braking and ESP[®] cannot carry out vehicle stabilization.</p> <p data-bbox="565 477 1677 526">The steering capability and braking characteristics are thus severely impaired. The braking distance in an emergency braking situation can increase. In addition, other driving safety systems are switched off.</p> <ul style="list-style-type: none"> <li data-bbox="565 539 778 560">▶ Drive on carefully. <li data-bbox="565 573 1360 594">▶ Have ABS and ESP[®] checked immediately at a qualified specialist workshop. </div> <ul style="list-style-type: none"> <li data-bbox="547 625 1594 646">▶ Carefully drive on a suitable stretch of road, taking gentle bends at a speed above 19 mph (30 km/h). <li data-bbox="547 659 1687 680">▶ If the display message does not disappear, consult a qualified specialist workshop immediately. Drive carefully.

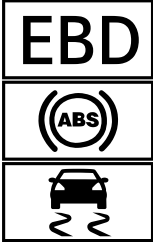
Display messages	Possible causes/consequences and Solutions
 <p data-bbox="144 418 417 467">Inoperative See Operator's Manual</p>	<p data-bbox="476 241 1208 301">* ABS and ESP[®] are malfunctioning. Other driving systems and driving safety systems may also malfunction.</p> <div data-bbox="500 322 1646 363"><p data-bbox="513 329 1190 356">▲ WARNING Risk of skidding if ABS and ESP[®] are malfunctioning</p></div> <p data-bbox="513 373 1591 422">If ABS and ESP[®] are malfunctioning, the wheels could lock when braking and ESP[®] cannot carry out vehicle stabilization.</p> <p data-bbox="513 436 1628 484">The steering capability and braking characteristics are thus severely impaired. The braking distance in an emergency braking situation can increase. In addition, other driving safety systems are switched off.</p> <ul data-bbox="513 498 1313 560" style="list-style-type: none"><li data-bbox="513 498 728 519">▶ Drive on carefully.<li data-bbox="513 532 1313 560">▶ Have ABS and ESP[®] checked immediately at a qualified specialist workshop. <ul data-bbox="500 584 1055 643" style="list-style-type: none"><li data-bbox="500 584 709 605">▶ Drive on carefully.<li data-bbox="500 618 1055 643">▶ Consult a qualified specialist workshop immediately.

Display messages	Possible causes/consequences and Solutions
 <p data-bbox="195 505 469 552">Inoperative See Operator's Manual</p>	<p data-bbox="526 241 1258 301">* EBD, ABS and ESP® are malfunctioning. Other driving systems and driving safety systems may also malfunction.</p> <div data-bbox="550 319 1698 366" style="background-color: #e0e0e0; padding: 5px;"> <p data-bbox="565 329 1295 358">▲ WARNING Risk of skidding if EBD, ABS and ESP® are malfunctioning</p> </div> <p data-bbox="561 370 1674 422">If EBD, ABS and ESP® are malfunctioning, the wheels can lock when braking and ESP® cannot carry out vehicle stabilization.</p> <p data-bbox="561 436 1674 484">The steering capability and braking characteristics are thus severely impaired. The braking distance in an emergency braking situation can increase. In addition, other driving safety systems are switched off.</p> <ul data-bbox="561 495 1387 555" style="list-style-type: none"> <li data-bbox="561 495 778 519">▶ Drive on carefully. <li data-bbox="561 529 1387 555">▶ Have the brake system checked immediately at a qualified specialist workshop. <ul data-bbox="543 581 1105 641" style="list-style-type: none"> <li data-bbox="543 581 759 605">▶ Drive on carefully. <li data-bbox="543 615 1105 641">▶ Consult a qualified specialist workshop immediately.

Display messages	Possible causes/consequences and Solutions
 <p data-bbox="144 334 408 384">Currently Unavailable See Operator's Manual</p>	<p data-bbox="476 241 1208 303">* ESP® is temporarily unavailable. Other driving systems and driving safety systems may also malfunction.</p> <div data-bbox="497 322 1648 506"><p data-bbox="513 329 1081 358">▲ WARNING Risk of skidding if ESP is malfunctioning®</p><p data-bbox="513 373 1609 423">If ESP® is malfunctioning, ESP® cannot carry out vehicle stabilization. In addition, other driving safety systems are switched off.</p><ul data-bbox="513 436 1092 496" style="list-style-type: none"><li data-bbox="513 436 728 459">▶ Drive on carefully.<li data-bbox="513 470 1092 496">▶ Have ESP® checked at a qualified specialist workshop.</div> <p data-bbox="497 524 1544 550">▶ Carefully drive on a suitable stretch of road, taking gentle bends at a speed above 19 mph (30 km/h).</p> <p data-bbox="497 560 1633 585">▶ If the display message does not disappear, consult a qualified specialist workshop immediately. Drive carefully.</p>









Display messages	Possible causes/consequences and Solutions
 <p data-bbox="195 335 469 381">Inoperative See Operator's Manual</p>	<p data-bbox="526 242 783 267">* ESP® is malfunctioning.</p> <p data-bbox="545 277 1258 302">Other driving systems and driving safety systems may also malfunction.</p> <p data-bbox="545 312 1633 358">The brake system continues to operate normally. The braking distance in an emergency braking situation can increase.</p> <div data-bbox="545 381 1700 567"><p data-bbox="565 391 1134 416">▲ WARNING Risk of skidding if ESP is malfunctioning®</p><p data-bbox="565 435 1665 480">If ESP® is malfunctioning, ESP® cannot carry out vehicle stabilization. In addition, other driving safety systems are switched off.</p><ul data-bbox="565 495 1142 557" style="list-style-type: none"><li data-bbox="565 495 778 520">▶ Drive on carefully.<li data-bbox="565 530 1142 557">▶ Have ESP® checked at a qualified specialist workshop.</div> <ul data-bbox="545 584 1105 644" style="list-style-type: none"><li data-bbox="545 584 759 609">▶ Drive on carefully.<li data-bbox="545 619 1105 644">▶ Consult a qualified specialist workshop immediately.







Display messages	Possible causes/consequences and Solutions
 <p>only) (USA ada only) (Can- Check Brake Fluid Level</p>	<p>* There is not enough brake fluid in the brake fluid reservoir.</p> <div style="border: 1px solid gray; padding: 5px; margin: 5px 0;"> <p>▲ WARNING Risk of an accident due to low brake fluid level</p> <p>If the brake fluid level is too low, the braking effect and the braking characteristics may be impaired.</p> <ul style="list-style-type: none"> ▶ Pull over and stop the vehicle safely as soon as possible, paying attention to road and traffic conditions. Do not continue driving under any circumstances. ▶ Consult a qualified specialist workshop. Do not add brake fluid. </div> <ul style="list-style-type: none"> ▶ Pull over and stop the vehicle safely as soon as possible, paying attention to road and traffic conditions. Do not continue driving under any circumstances. ▶ Consult a qualified specialist workshop. Do not add brake fluid.
 <p>Check Brake Pad Wear</p>	<p>* The brake linings have reached their wear limit.</p> <ul style="list-style-type: none"> ▶ Consult a qualified specialist workshop.





Display messages	Possible causes/consequences and Solutions
<p>Radar Sensors Dirty See Operator's Manual</p>	<p>* The radar sensor system is malfunctioning. Possible causes are:</p> <ul style="list-style-type: none"> • soiling of the sensors • heavy rain • extended driving on inter-urban roads without moving traffic, e.g. in the desert <p>Driving systems and driving safety systems may be malfunctioning or temporarily unavailable. When the causes no longer apply, driving systems and driving safety systems are available again.</p> <p>If the display message does not disappear:</p> <ul style="list-style-type: none"> ▶ Pull over and stop the vehicle safely as soon as possible, paying attention to road and traffic conditions. ▶ Clean all sensors (→ page 271). ▶ Restart the engine.
<p>Active Brake Assist Functions Currently Limited See Operator's Manual</p>	<p>* Active Brake Assist with cross-traffic function, Evasive Steering Assist or PRE-SAFE® PLUS is temporarily unavailable or only partially available.</p> <p>The ambient conditions are outside the system limits (→ page 151).</p> <ul style="list-style-type: none"> ▶ Drive on. As soon as the ambient conditions are within the system limits, the systems will be available again. ▶ If the display message does not disappear, stop the vehicle while paying attention to road and traffic conditions and restart the engine.

344 Display messages and warning/indicator lamps



Display messages	Possible causes/consequences and Solutions
Active Brake Assist Functions Limited See Operator's Manual	<ul style="list-style-type: none">* Active Brake Assist with cross-traffic function, Evasive Steering Assist or PRE-SAFE® PLUS is malfunctioning.<ul style="list-style-type: none">▶ Visit a qualified specialist workshop.
Active Brake Assist Functions Currently Limited See Operator's Manual	<ul style="list-style-type: none">* Active Brake Assist is temporarily unavailable. The ambient conditions are outside the system limits .<ul style="list-style-type: none">▶ Drive on. As soon as the ambient conditions are within the system limits, the system will become available again.▶ If the display message does not disappear, pull over and stop the vehicle safely, paying attention to road and traffic conditions and restart the engine.
Active Brake Assist Functions Limited See Operator's Manual	<ul style="list-style-type: none">* Active Brake Assist is malfunctioning.<ul style="list-style-type: none">▶ Visit a qualified specialist workshop.
PRE-SAFE Impulse Side Inoperative See Operator's Manual	<ul style="list-style-type: none">* PRE-SAFE® Impulse Side is malfunctioning or inoperative after having already been triggered.<ul style="list-style-type: none">▶ Visit a qualified specialist workshop.
PRE-SAFE Inoperative See Operator's Manual	<ul style="list-style-type: none">* PRE-SAFE® functions are malfunctioning.<ul style="list-style-type: none">▶ Consult a qualified specialist workshop.





Display messages	Possible causes/consequences and Solutions
 (USA only)  (Canada only) Turn On the Ignition to Release the Parking Brake	<p>* The red  (USA only) or  (Canada only) indicator lamp is lit.</p> <p>You have attempted to release the electric parking brake with the ignition is switched.</p> <ul style="list-style-type: none"> ▶ Switch on the ignition.
 (USA only)  (Canada only) Please Release Parking Brake	<p>* The red  (USA only) or  (Canada only) indicator lamp is flashing.</p> <p>The electric parking brake is applied while driving:</p> <ul style="list-style-type: none"> • A condition for automatic release of the electric parking brake is not fulfilled (→ page 144). • You are performing emergency braking using the electric parking brake (→ page 145). <ul style="list-style-type: none"> ▶ Check that the conditions for automatic release of the electric parking brake are fulfilled. ▶ Release the electric parking brake manually.

Display messages	Possible causes/consequences and Solutions
<div data-bbox="155 242 371 325" style="border: 1px solid black; padding: 5px; display: inline-block;"> PARK (USA) </div> <div data-bbox="144 329 421 433" style="display: inline-block; vertical-align: middle;"> only) <div data-bbox="205 329 362 412" style="border: 1px solid black; padding: 5px; display: inline-block; text-align: center;">  </div> (Canada only) </div> <div data-bbox="144 443 408 495" style="color: blue;"> Parking Brake See Operator's Manual </div>	<p>* The yellow  indicator lamp is lit. The electric parking brake is malfunctioning.</p> <p>To apply:</p> <ul style="list-style-type: none"> ▶ Switch off the ignition and turn it back on. ▶ Apply the electric parking brake manually (→ page 145). <p>If it is not possible to engage the electric parking brake:</p> <ul style="list-style-type: none"> ▶ Visit a qualified specialist workshop. ▶ Where necessary, also safeguard the parked vehicle against rolling away. <p>The yellow  indicator lamp and the red PARK (USA only) or  (Canada only) indicator lamp are lit. The electric parking brake is malfunctioning.</p> <p>To release:</p> <ul style="list-style-type: none"> ▶ Switch off the ignition and turn it back on. ▶ Release the electric parking brake manually (→ page 145). <p>or</p> <ul style="list-style-type: none"> ▶ Release the electric parking brake automatically (→ page 143) (→ page 144). <p>If it is still not possible to release the electric parking brake:</p> <ul style="list-style-type: none"> ▶ Do not continue driving under any circumstances. Consult a qualified specialist workshop. <p>The yellow  indicator lamp is lit and the red PARK (USA only) or  (Canada only) indicator lamp is flashing. The electric parking brake is malfunctioning.</p> <p>The electric parking brake could not be applied or released.</p>

Display messages	Possible causes/consequences and Solutions
	<ul style="list-style-type: none">▶ Switch off the ignition and turn it back on. <p>To apply:</p> <ul style="list-style-type: none">▶ Release and then apply the electric parking brake manually (→ page 145). <p>To release:</p> <ul style="list-style-type: none">▶ Release and then apply the electric parking brake manually. <p>If the electric parking brake cannot be applied or the red  (USA only) or  (Canada only) indicator lamp continues to flash:</p> <ul style="list-style-type: none">▶ Do not continue driving under any circumstances. Consult a qualified specialist workshop.▶ Where necessary, also safeguard the parked vehicle against rolling away. <p>The yellow  indicator lamp is lit and the red  (USA only) or  (Canada only) indicator lamp flashes for approximately ten seconds after the electric parking brake has been applied or released. It then remains lit or goes out. The electric parking brake is malfunctioning.</p> <p>If the battery charge level is too low:</p> <ul style="list-style-type: none">▶ Charge the battery. <p>To apply:</p> <ul style="list-style-type: none">▶ Switch the ignition off. The electric parking brake is applied automatically.

Display messages	Possible causes/consequences and Solutions
	<p>If you do not wish the electric parking brake to be applied, leave the ignition switched on, e.g. when washing the vehicle in an automatic car wash or when having the vehicle towed away. Do not do this when having the vehicle towed with the rear axle raised.</p> <p>If the electric parking brake is not applied automatically:</p> <ul style="list-style-type: none">▶ Switch off the ignition and turn it back on.▶ Release and then apply the electric parking brake manually (→ page 145). <p>If it is still not possible to apply the electric parking brake:</p> <ul style="list-style-type: none">▶ Visit a qualified specialist workshop.▶ Where necessary, also safeguard the parked vehicle against rolling away. <p>To release:</p> <ul style="list-style-type: none">▶ If the conditions for automatic release are fulfilled and the electric parking brake is not released automatically, release the electric parking brake manually (→ page 145). <p>If it is still not possible to release the electric parking brake:</p> <ul style="list-style-type: none">▶ Do not continue driving under any circumstances. Consult a qualified specialist workshop.





Display messages	Possible causes/consequences and Solutions
 <p data-bbox="195 334 445 384">SRS Malfunction Service Required</p>	<p data-bbox="526 239 1060 265">* The restraint system is malfunctioning (→ page 31).</p> <div data-bbox="550 283 1696 453" style="border: 1px solid gray; padding: 5px;"><p data-bbox="565 293 1434 319">⚠ WARNING Risk of injury or fatal injury due to a malfunction in the restraint system</p><p data-bbox="561 332 1646 410">If the restraint system is malfunctioning, restraint system components may be triggered unintentionally or might not be triggered at all in the event of an accident. This may affect the Emergency Tensioning Device or airbag, for example.</p><p data-bbox="561 420 1548 446">▶ Have the restraint system checked and repaired immediately at a qualified specialist workshop.</p></div> <p data-bbox="545 472 975 498">Recognizing a restraint system malfunction</p> <ul data-bbox="550 508 1520 565" style="list-style-type: none"><li data-bbox="550 508 1489 534">• The  restraint system warning lamp does not light up when the ignition is switched on.<li data-bbox="550 539 1520 565">• The  restraint system warning lamp lights up continuously or repeatedly during a journey. <p data-bbox="545 581 1069 607">▶ Visit a qualified specialist workshop immediately.</p>



Display messages	Possible causes/consequences and Solutions
 <p data-bbox="144 332 408 381">Example: Front Left Malfunction Service Required</p>	<p data-bbox="476 239 1160 263">* The corresponding restraint system is malfunctioning (→ page 31).</p> <div data-bbox="500 283 1648 453" style="border: 1px solid gray; padding: 5px;"> <p data-bbox="513 291 1382 314">⚠ WARNING Risk of injury or fatal injury due to a malfunction in the restraint system</p> <p data-bbox="513 329 1596 408">If the restraint system is malfunctioning, restraint system components may be triggered unintentionally or might not be triggered at all in the event of an accident. This may affect the Emergency Tensioning Device or airbag, for example.</p> <p data-bbox="513 418 1498 442">▶ Have the restraint system checked and repaired immediately at a qualified specialist workshop.</p> </div> <p data-bbox="495 470 925 494">Recognizing a restraint system malfunction</p> <ul data-bbox="500 504 1471 563" style="list-style-type: none"> • The  restraint system warning lamp does not light up when the ignition is switched on. • The  restraint system warning lamp lights up continuously or repeatedly during a journey. <p data-bbox="495 581 1018 605">▶ Visit a qualified specialist workshop immediately.</p>
 <p data-bbox="144 712 417 788">Example: Left Side Curtain Airbag Malfunction Service Required</p>	<p data-bbox="476 619 1142 643">* The corresponding window airbag is malfunctioning (→ page 37).</p> <div data-bbox="500 664 1648 806" style="border: 1px solid gray; padding: 5px;"> <p data-bbox="513 671 1356 695">⚠ WARNING Risk of injury or fatal injury due to malfunctions in the window airbag</p> <p data-bbox="513 709 1596 757">If the window airbag is malfunctioning, it might be triggered unintentionally or might not be triggered at all in the event of an accident with high deceleration.</p> <p data-bbox="513 771 1480 795">▶ Have the window airbag checked and repaired immediately at a qualified specialist workshop.</p> </div> <p data-bbox="495 823 1055 847">▶ Consult a qualified specialist workshop immediately.</p>



Display messages	Possible causes/consequences and Solutions
 <p data-bbox="195 335 310 358">Inoperative</p>	<ul style="list-style-type: none"> * One or more main features of the mbrace system are malfunctioning. <ul style="list-style-type: none"> ▶ Visit a qualified specialist workshop.
<p data-bbox="195 370 476 445">Front Passenger Airbag Disabled See Operator's Manual</p>	<ul style="list-style-type: none"> * The front passenger air bag and the knee air bag are deactivated, even though an adult or a person with a build corresponding to that of an adult is seated on the front passenger seat. If additional forces are applied to the seat, the system may interpret the occupant's weight as lower than it actually is. <div data-bbox="547 467 1696 505" style="background-color: #e0e0e0; padding: 5px;"> <p>⚠ WARNING Risk of injury or fatal injury due to a disabled front passenger airbag</p> </div> <div data-bbox="547 513 1696 671" style="border: 1px solid #ccc; padding: 5px;"> <p>If the front passenger airbag is disabled, the front passenger airbag will not be deployed in the event of an accident and cannot perform its intended protective function.</p> <p>A person in the front passenger seat could then, for example, come into contact with the vehicle's interior, especially if the person is sitting too close to the cockpit.</p> <ul style="list-style-type: none"> ▶ Make sure, both before and during the journey, that the status of the front passenger airbag is correct. </div> <ul style="list-style-type: none"> ▶ Pull over and stop the vehicle safely as soon as possible, paying attention to road and traffic conditions. ▶ Check the status of the automatic front passenger air bag shutoff (→ page 41) . ▶ If necessary, consult a qualified specialist workshop immediately.

Display messages	Possible causes/consequences and Solutions
<p>Front Passenger Airbag Enabled See Operator's Manual</p>	<p>* The front passenger air bag and knee air bags are enabled during the journey:</p> <ul style="list-style-type: none"> • Even when a child, a small adult or an object weighing less than the system weight threshold is located on the front passenger seat. • Even when the front passenger seat is not occupied. <p>The system may detect objects or forces that are adding to the weight applied to the seat.</p> <div style="background-color: #f0f0f0; padding: 5px; border: 1px solid #ccc;"> <p>⚠ WARNING Risk of injury or fatal injury by using a child restraint system with the front passenger airbag enabled</p> </div> <p>If you secure a child in a child restraint system on the front passenger seat and the front passenger airbag is enabled, the front passenger airbag can deploy in the event of an accident. The child could be struck by the airbag.</p> <ul style="list-style-type: none"> ▶ Make sure, both before and during the journey, that the status of the front passenger airbag is correct. <ul style="list-style-type: none"> ▶ Pull over and stop the vehicle safely as soon as possible, paying attention to road and traffic conditions. ▶ Check the status of the automatic front passenger air bag shutoff (→ page 41) . ▶ If necessary, consult a qualified specialist workshop immediately.

Driving systems

Display messages	Possible causes/consequences and Solutions
 <p>ATTENTION ASSIST: Take a Break!</p>	<ul style="list-style-type: none"> * ATTENTION ASSIST has detected fatigue or an increasing lack of concentration on the part of the driver (→ page 182) . <ul style="list-style-type: none"> ▶ If necessary, take a break.
 <p>ATTENTION ASSIST Inoperative</p>	<ul style="list-style-type: none"> * ATTENTION ASSIST is malfunctioning. <ul style="list-style-type: none"> ▶ Visit a qualified specialist workshop.
 <p>Off</p>	<ul style="list-style-type: none"> * The HOLD function is deactivated because the vehicle is skidding or a condition for activation is not met. <ul style="list-style-type: none"> ▶ Reactivate the HOLD function later or check the activation conditions for the HOLD function (→ page 166).
 <p>Vehicle Rising Please Wait</p>	<ul style="list-style-type: none"> * The vehicle level is too low and the vehicle rises to the selected vehicle level. <ul style="list-style-type: none"> ▶ Wait until the display message disappears before pulling away.

Display messages	Possible causes/consequences and Solutions
 <p data-bbox="144 332 397 381">Stop Vehicle Vehicle Too Low</p>	<p data-bbox="476 239 1097 263">* You have pulled away although the vehicle level was too low.</p> <ul style="list-style-type: none"> <li data-bbox="495 273 1567 325">▶ Pull over and stop the vehicle safely as soon as possible, paying attention to road and traffic conditions. The vehicle rises to the selected vehicle level. <li data-bbox="495 335 1153 359">▶ Wait until the display message disappears before pulling away. <p data-bbox="495 384 1637 408">If the display message does not disappear and a warning tone also sounds, AIR BODY CONTROL is malfunctioning:</p> <ul style="list-style-type: none"> <li data-bbox="495 418 1530 442">▶ Do not drive faster than 50 mph (80 km/h) and consult a qualified specialist workshop immediately. <div data-bbox="500 470 1646 617" style="border: 1px solid black; padding: 5px;"> <p data-bbox="513 480 1559 504">! NOTE The tires of the front axle or the front fenders could be damaged by large steering movements</p> <ul style="list-style-type: none"> <li data-bbox="513 522 1313 545">▶ Avoid large steering movements while driving and listen for scraping sounds. <li data-bbox="513 556 1604 608">▶ If you hear scraping sounds, pull over and stop the vehicle safely, paying attention to road and traffic conditions, and set a higher vehicle level if possible. </div> <ul style="list-style-type: none"> <li data-bbox="495 632 1049 684">▶ Set a higher vehicle level (→ page 169). Depending on the malfunction, the vehicle is raised.
 <p data-bbox="144 793 328 817">Drive More Slowly</p>	<p data-bbox="476 700 1023 724">* You are driving too fast for the selected vehicle level.</p> <ul style="list-style-type: none"> <li data-bbox="495 734 1363 758">▶ When adjusting the vehicle level, you must not drive faster than 50 mph (80 km/h). <li data-bbox="495 768 1596 792">▶ When adjusting the vehicle level during trailer operation, you must not drive faster than 19 mph (30 km/h).

Display messages	Possible causes/consequences and Solutions
 <p>Vehicle Rising</p>	<ul style="list-style-type: none"> * Your vehicle is adjusting to the level you have selected.
 <p>Compressor Is Cooling</p>	<ul style="list-style-type: none"> * Due to frequent level changes within a short space of time, the compressor first needs to cool down in order to set the selected vehicle level. <ul style="list-style-type: none"> ▶ Drive on in a manner appropriate for the current level. Make sure that there is sufficient ground clearance. When the compressor has cooled down, the vehicle continues rising to the selected vehicle level.
 <p>Malfunction See Operator's Manual</p>	<ul style="list-style-type: none"> * AIR BODY CONTROL function is restricted. The vehicle's handling characteristics may be affected. <ul style="list-style-type: none"> ▶ Drive in a manner appropriate for the current level, but do not exceed 50 mph (80 km/h). ▶ Consult a qualified specialist workshop.

Display messages	Possible causes/consequences and Solutions
<p>Active Lane Keeping Assist Currently Unavailable See Operator's Manual</p>	<p>* Active Lane keeping Assist is temporarily unavailable. The ambient conditions are outside the system limits (→ page 186). Vehicles with Steering Pilot: The camera view may be restricted by the windshield.</p> <ul style="list-style-type: none">▶ Drive on. As soon as the ambient conditions are within the system limits, the system will become available again. <p>If the display message does not disappear on vehicles with Steering Pilot:</p> <ul style="list-style-type: none">▶ Pull over and stop the vehicle safely as soon as possible, paying attention to road and traffic conditions.▶ Clean the windshield.
<p>Active Lane Keeping Assist Inoperative</p>	<p>* Active Lane Keeping Assist is malfunctioning.</p> <ul style="list-style-type: none">▶ Visit a qualified specialist workshop.

Display messages	Possible causes/consequences and Solutions
<p>Active Lane Keeping Assist Camera View Restricted See Operator's Manual</p>	<p>* Vehicles without Steering Pilot: The camera view is reduced. Possible causes are:</p> <ul style="list-style-type: none"> • Dirt on the windshield in the camera's field of vision • Heavy rain, snow or fog <p>Driving systems and driving safety systems may be malfunctioning or temporarily unavailable. When the causes no longer apply, driving systems and driving safety systems are available again. If the display message does not disappear:</p> <ul style="list-style-type: none"> ▶ Pull over and stop the vehicle safely, paying attention to road and traffic conditions. ▶ Clean the windshield.
<p>Blind Spot Assist Currently Unavailable See Operator's Manual</p>	<p>* Blind Spot Assist is temporarily unavailable. The system limits have been reached (→ page 184) .</p> <ul style="list-style-type: none"> ▶ Drive on. When the causes no longer apply, the system will be available again. <p>or</p> <ul style="list-style-type: none"> ▶ If the display message does not disappear, pull over and stop the vehicle while paying attention to road and traffic conditions and restart the engine. ▶ If necessary, clean the sensors in the rear bumper.



Display messages	Possible causes/consequences and Solutions
Blind Spot Assist Not Available When Towing a Trailer See Operator's Manual	<ul style="list-style-type: none"> * When you establish the electrical connection to the trailer, Blind Spot Assist is unavailable. <ul style="list-style-type: none"> ▶ Press the left-hand side of Touch Control and confirm the display message.
Blind Spot Assist Inoperative	<ul style="list-style-type: none"> * Blind Spot Assist is malfunctioning. <ul style="list-style-type: none"> ▶ Visit a qualified specialist workshop.
Active Blind Spot Assist Currently Unavailable See Operator's Manual	<ul style="list-style-type: none"> * Active Blind Spot Assist is temporarily unavailable. The system limits have been reached (→ page 184) . <ul style="list-style-type: none"> ▶ Drive on. When the causes no longer apply, the system will be available again. ▶ If the display message does not disappear, pull over and stop the vehicle while paying attention to road and traffic conditions and restart the engine.
Active Blind Spot Asst. Not Available When Towing a Trailer See Operator's Manual	<ul style="list-style-type: none"> * When you establish the electrical connection to the trailer, Active Blind Spot Assist is unavailable. <ul style="list-style-type: none"> ▶ Press the left-hand side of Touch Control and confirm the display message.
Active Blind Spot Assist Inoperative	<ul style="list-style-type: none"> * Active Blind Spot Assist is malfunctioning. <ul style="list-style-type: none"> ▶ Visit a qualified specialist workshop.

Display messages	Possible causes/consequences and Solutions
<p>Steering Pilot Currently Unavailable See Operator's Manual</p>	<ul style="list-style-type: none"> * Steering Pilot is temporarily unavailable. The ambient conditions are outside the system limits (→ page 163). <ul style="list-style-type: none"> ▶ Drive on. As soon as the ambient conditions are within the system limits, the system will become available again. ▶ If necessary, clean the windshield in the camera's field of vision.
<p>Steering Pilot Inoperative</p>	<ul style="list-style-type: none"> * Steering Pilot is malfunctioning. Distance Pilot DISTRONIC remains available. <ul style="list-style-type: none"> ▶ Visit a qualified specialist workshop.
<p>Distance Pilot Inoperative</p>	<ul style="list-style-type: none"> * Distance Pilot DISTRONIC is malfunctioning. Other driving systems and driving safety systems may also malfunction. <ul style="list-style-type: none"> ▶ Visit a qualified specialist workshop.
<p>Distance Pilot Now Available</p>	<ul style="list-style-type: none"> * Distance Pilot DISTRONIC is operational again and can be activated (→ page 160).
<p>Distance Pilot Currently Unavailable See Operator's Manual</p>	<ul style="list-style-type: none"> * Distance Pilot DISTRONIC is temporarily unavailable. The ambient conditions are outside the system limits (→ page 158). <ul style="list-style-type: none"> ▶ Drive on. As soon as the ambient conditions are within the system limits, the system will become available again.
 <p>--- mph</p>	<ul style="list-style-type: none"> * Cruise control cannot be activated as not all activation conditions are fulfilled. <ul style="list-style-type: none"> ▶ Observe the activation conditions for cruise control (→ page 156).

Display messages	Possible causes/consequences and Solutions
Cruise Control Off	<ul style="list-style-type: none"> * Cruise control has been deactivated. If there is an additional warning tone, cruise control has been switched off automatically (→ page 156) .
Cruise Control Inoperative	<ul style="list-style-type: none"> * Cruise control is malfunctioning. <ul style="list-style-type: none"> ▶ Consult a qualified specialist workshop.
Parking Pilot and PARKTRONIC Inoperative See Operator's Manual	<ul style="list-style-type: none"> * Parking Pilot and Parking Assist PARKTRONIC are malfunctioning. <ul style="list-style-type: none"> ▶ Pull over and stop the vehicle safely, paying attention to road and traffic conditions and restart the engine. ▶ If the display message continues to be displayed, consult a qualified specialist workshop.
Example: Parking Pilot Parking Canceled	<ul style="list-style-type: none"> * Parking assistance systems from the Parking Pilot were interrupted. You have opened the driver's door or touched the steering wheel, for example. <ul style="list-style-type: none"> ▶ Steer and brake manually.



Engine

Display messages	Possible causes/consequences and Solutions
Check Coolant Level See Operator's Manual	<ul style="list-style-type: none"> * The coolant level is too low. <div style="border: 1px solid black; padding: 5px; margin: 5px 0;"> <p>! NOTE Engine damage due to insufficient coolant</p> <ul style="list-style-type: none"> ▶ Avoid long journeys with insufficient coolant. </div> <ul style="list-style-type: none"> ▶ Add coolant (→ page 266).

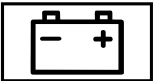
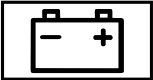
Display messages	Possible causes/consequences and Solutions
 <p data-bbox="195 335 473 384">Coolant Too Hot Stop Vehicle Turn Engine Off</p>	<p data-bbox="528 241 768 262">* The coolant is too hot.</p> <ul style="list-style-type: none"> <li data-bbox="547 275 1674 296">▶ Pull over and stop the vehicle safely and switch off the engine, paying attention to road and traffic conditions. <div data-bbox="547 324 1702 505" style="border: 1px solid gray; padding: 5px;"> <p data-bbox="565 334 1193 355">⚠ WARNING Danger of burns when opening the engine hood</p> <p data-bbox="565 376 1655 427">If you open the engine hood when the engine has overheated or during a fire in the engine compartment, you could come into contact with hot gases or other escaping operating fluids.</p> <ul style="list-style-type: none"> <li data-bbox="565 438 1230 458">▶ Before opening the engine hood, allow the engine to cool down. <li data-bbox="565 469 1618 490">▶ In the event of a fire in the engine compartment, keep the engine hood closed and call the fire service. </div> <ul style="list-style-type: none"> <li data-bbox="547 524 972 544">▶ Wait until the engine has cooled down. <li data-bbox="547 555 1212 576">▶ Make sure that the air supply to the radiator is not obstructed. <li data-bbox="547 586 1692 638">▶ Avoiding high loads on the engine, drive on to the nearest qualified specialist workshop. When doing so, ensure that the coolant temperature display remains below 248 °F (120 °C).
	<p data-bbox="528 655 768 676">* The fan motor is faulty.</p> <ul style="list-style-type: none"> <li data-bbox="547 689 1692 741">▶ Avoiding high loads on the engine, drive on to the nearest qualified specialist workshop. In doing so, ensure that the coolant temperature display remains below 248 °F (120 °C).

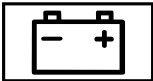
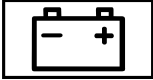

Display messages	Possible causes/consequences and Solutions
 <p data-bbox="144 332 376 356">See Operator's Manual</p>	<p data-bbox="476 239 824 263">* The battery is not being charged.</p> <div data-bbox="500 283 1648 405" style="border: 1px solid black; padding: 5px;"> <p data-bbox="513 291 1092 314">! NOTE Possible engine damage if you continue driving</p> <ul style="list-style-type: none"> <li data-bbox="513 332 1045 356">▶ Do not continue driving under any circumstances. <li data-bbox="513 366 944 390">▶ Consult a qualified specialist workshop. </div> <ul style="list-style-type: none"> <li data-bbox="495 418 1624 442">▶ Pull over and stop the vehicle safely and switch off the engine, paying attention to road and traffic conditions. <li data-bbox="495 452 925 476">▶ Consult a qualified specialist workshop.
 <p data-bbox="144 584 389 631">Start Engine See Operator's Manual</p>	<p data-bbox="476 491 1055 514">* The engine is off and the battery charge level is too low.</p> <ul style="list-style-type: none"> <li data-bbox="495 525 1064 549">▶ Switch off electrical consumers that are not required. <li data-bbox="495 559 1264 608">▶ Leave the engine running for a few minutes, or drive for a longer distance. The battery is being charged.

Display messages	Possible causes/consequences and Solutions
 <p data-bbox="195 332 439 381">Stop vehicle See Operator's Manual</p>	<p data-bbox="526 239 1323 263">* The battery is no longer being charged and the battery charge level is too low.</p> <div data-bbox="547 282 1696 405" style="border: 1px solid black; padding: 5px;"> <p data-bbox="565 291 1142 317">! NOTE Possible engine damage if you continue driving</p> <ul style="list-style-type: none"> <li data-bbox="565 332 1095 358">▶ Do not continue driving under any circumstances. <li data-bbox="565 366 994 392">▶ Consult a qualified specialist workshop. </div> <ul style="list-style-type: none"> <li data-bbox="547 420 1692 469">▶ Pull over and stop the vehicle safely as soon as possible, paying attention to road and traffic conditions. Do not continue driving under any circumstances. <li data-bbox="547 480 800 506">▶ Switch off the engine. <li data-bbox="547 514 977 540">▶ Consult a qualified specialist workshop.
 <p data-bbox="195 647 463 696">Stop Vehicle Leave Engine Running</p>	<p data-bbox="526 553 892 577">* The battery charge level is too low.</p> <ul style="list-style-type: none"> <li data-bbox="547 586 1692 635">▶ Pull over and stop the vehicle safely as soon as possible, paying attention to road and traffic conditions. Do not continue driving under any circumstances. <li data-bbox="547 646 750 672">▶ Start the engine. <li data-bbox="547 680 1203 706">▶ Wait until the display message disappears before pulling away.

Display messages	Possible causes/consequences and Solutions
 <p data-bbox="144 332 402 381">Check Engine Oil At Next Refueling</p>	<p data-bbox="476 239 1036 263">* The engine oil level has dropped to the minimum level.</p> <div data-bbox="500 283 1646 366" style="border: 1px solid black; padding: 5px;"> <p data-bbox="513 291 1221 314">! NOTE Engine damage caused by driving with insufficient engine oil</p> <p data-bbox="513 332 1018 356">▶ Avoid long journeys with insufficient engine oil.</p> </div> <p data-bbox="495 384 994 408">▶ Check the engine oil level when next refueling.</p> <p data-bbox="495 425 787 449">Add engine oil (→ page 265).</p> <p data-bbox="495 462 837 485">Notes on engine oil (→ page 330).</p>
 <p data-bbox="144 591 297 615">Gas Cap Loose</p>	<p data-bbox="476 498 1591 550">* There has been pressure loss in the fuel system. The fuel filler cap is not closed correctly or the fuel system is leaking.</p> <p data-bbox="495 560 768 584">▶ Close the fuel filler cap.</p> <p data-bbox="495 591 1448 615">▶ If the fuel filler cap was already properly closed: consult a qualified specialist workshop.</p>
 <p data-bbox="144 726 297 750">Fuel Level Low</p>	<p data-bbox="476 632 990 656">* The fuel level has dropped into the reserve range.</p> <p data-bbox="495 664 598 687">▶ Refuel.</p>

Tires

Display messages	Possible causes/consequences and Solutions
<p>Tire Press. Monitor Currently Unavailable</p>	<ul style="list-style-type: none"> * A strong radio signal source is interfering so that no signals can be received from the tire pressure sensors. The tire pressure monitoring system is temporarily unavailable. <ul style="list-style-type: none"> ▶ Drive on. ▶ The tire pressure monitoring system switches itself on automatically as soon as the cause has been rectified.
<div data-bbox="205 410 364 491" data-label="Image"> </div> <p>Check Tires</p>	<ul style="list-style-type: none"> * The tire pressure in one or more tires has dropped significantly. The wheel position is displayed. <div data-bbox="563 448 1696 484" data-label="Section-Header" style="background-color: #e0e0e0; padding: 5px;"> <p>⚠ WARNING Risk of an accident due to insufficient tire pressure</p> </div> <p>Tire pressures that are too low pose the following hazards:</p> <ul style="list-style-type: none"> • The tires may burst, especially as the load and vehicle speed increase. • The tires may wear excessively and/or unevenly, which may greatly impair tire traction. • The driving characteristics, as well as steering and braking, may be greatly impaired. <p>You could then lose control of the vehicle.</p> <ul style="list-style-type: none"> ▶ Observe the recommended tire pressure. ▶ Adjust the tire pressure if necessary. ▶ Stop the vehicle, paying attention to road and traffic conditions. ▶ Check the tire pressure (→ page 297) and the tires.



Display messages	Possible causes/consequences and Solutions
 <p data-bbox="144 332 397 381">Please Correct Tire Pressure</p>	<p data-bbox="476 239 1609 291">* The tire pressure is too low in at least one of the tires, or the tire pressure difference between the wheels is too great.</p> <ul style="list-style-type: none"> <li data-bbox="495 301 1018 327">▶ Check the tire pressure and add air, if necessary. <li data-bbox="495 332 1448 358">▶ When the tire pressure is correct, restart the tire pressure monitoring system (→ page 302).
 <p data-bbox="144 490 397 515">Warning Tire Malfunction</p>	<p data-bbox="476 396 1421 422">* The tire pressure in one or more tires has dropped suddenly. The wheel position is displayed.</p> <div data-bbox="495 438 1646 702" style="border: 1px solid gray; padding: 5px;"> <p data-bbox="513 448 1130 474">⚠ WARNING Risk of an accident from driving with a flat tire</p> <p data-bbox="513 490 968 515">Flat tires are dangerous in the following ways:</p> <ul style="list-style-type: none"> <li data-bbox="519 521 944 547">• The tires can overheat and cause a fire. <li data-bbox="519 552 1387 578">• The driving characteristics, as well as steering and braking, may be greatly impaired. <p data-bbox="513 593 931 619">You could then lose control of the vehicle.</p> <ul style="list-style-type: none"> <li data-bbox="513 624 820 650">▶ Do not drive with a flat tire. <li data-bbox="513 655 857 681">▶ Observe the notes on flat tires. </div> <p data-bbox="495 717 833 743">Notes for a flat tire (→ page 278).</p> <ul style="list-style-type: none"> <li data-bbox="495 749 1166 774">▶ Stop the vehicle, paying attention to road and traffic conditions. <li data-bbox="495 780 691 806">▶ Check the tires.



Display messages	Possible causes/consequences and Solutions
Tires Overheated Decrease Speed	<p>* At least one tire is overheated.</p> <div style="border: 1px solid gray; padding: 5px; margin: 5px 0;"> <p>⚠ WARNING Risk of an accident from driving with overheated tires</p> <p>Overheated tires may burst, particularly at high speeds.</p> <ul style="list-style-type: none"> ▶ Reduce speed so that the tires cool down. </div> <ul style="list-style-type: none"> ▶ Reduce speed so that the tires cool down.
Tires Overheated	<p>* At least one tire is overheated. The affected tires are displayed in red. At temperatures close to the limit value, the tires are displayed in yellow.</p> <ul style="list-style-type: none"> ▶ Drive more slowly.
Tire Press. Monitor Inoperative	<p>* The tire pressure monitoring system is faulty.</p> <div style="border: 1px solid gray; padding: 5px; margin: 5px 0;"> <p>⚠ WARNING There is a risk of an accident if the tire pressure monitoring system is malfunctioning</p> <p>If the tire pressure monitoring system is malfunctioning, it is not able to issue a warning if there is pressure loss in one or more of the tires.</p> <p>Underinflated tires may, for example, impair the driving, steering and braking characteristics.</p> <ul style="list-style-type: none"> ▶ Have the tire pressure monitoring system checked at a qualified specialist workshop. </div> <ul style="list-style-type: none"> ▶ Consult a qualified specialist workshop.

Display messages	Possible causes/consequences and Solutions
<p>Tire Pressure Monitor Inoperative No Wheel Sensors</p>	<ul style="list-style-type: none"> * The wheels mounted do not have suitable tire pressure sensors. The tire pressure monitoring system is deactivated. <ul style="list-style-type: none"> ▶ Mount wheels with suitable tire pressure sensors.
<div style="text-align: center;">  </div> <p>Wheel Sensor(s) Missing</p>	<ul style="list-style-type: none"> * There is no signal from the tire pressure sensor of one or several wheels. The tire affected displays no pressure value. <ul style="list-style-type: none"> ▶ Have the faulty tire pressure sensor replaced at a qualified specialist workshop.

SmartKey

Display messages	Possible causes/consequences and Solutions
<div style="text-align: center;">  </div> <p>Place the Key in the Marked Space See Operator's Manual</p>	<ul style="list-style-type: none"> * The SmartKey detection function is malfunctioning. <ul style="list-style-type: none"> ▶ Change the location of the SmartKey in the vehicle. ▶ Start the vehicle with the SmartKey in the stowage compartment (→ page 129).

Display messages	Possible causes/consequences and Solutions
 <p>Key Not Detected (red display message)</p>	<p>* The SmartKey cannot be detected and may no longer be in the vehicle. The SmartKey is no longer in the vehicle and you switch off the engine:</p> <ul style="list-style-type: none"> • You can no longer start the engine. • You cannot centrally lock the vehicle. <p>▶ Ensure that the SmartKey is in the vehicle.</p> <p>If the SmartKey detection function has a malfunction due to a strong radio signal source:</p> <ul style="list-style-type: none"> ▶ Pull over and stop the vehicle safely as soon as possible, paying attention to road and traffic conditions. ▶ Place the SmartKey in the stowage compartment for starting the engine with the SmartKey (→ page 129).
 <p>Key Not Detected (white display message)</p>	<p>* The SmartKey is currently undetected.</p> <ul style="list-style-type: none"> ▶ Change the location of the SmartKey in the vehicle. ▶ If the SmartKey is still not being recognized, start the engine with the SmartKey in the stowage compartment (→ page 129).
 <p>Don't Forget Your Key</p>	<p>* This message reminds you to take your SmartKey with you when you leave the vehicle.</p>



Display messages	Possible causes/consequences and Solutions
 <p>Replace Key Battery</p>	<ul style="list-style-type: none"> * The SmartKey battery is discharged. <ul style="list-style-type: none"> ▶ Change the battery (→ page 57).
 <p>Obtain a New Key</p>	<ul style="list-style-type: none"> * The SmartKey needs to be replaced. <ul style="list-style-type: none"> ▶ Consult a qualified specialist workshop.



Vehicle



Display messages	Possible causes/consequences and Solutions
<p>Apply Brake to Shift from 'P'</p>	<ul style="list-style-type: none"> * You have attempted to shift the transmission out of position P and into another transmission position. <ul style="list-style-type: none"> ▶ Depress the brake pedal.
<p>To Deselect P or N, Depress Brake and Start Engine</p>	<ul style="list-style-type: none"> * You have attempted to shift the transmission out of position P or N into another transmission position. <ul style="list-style-type: none"> ▶ Depress the brake pedal. ▶ Start the engine.

Display messages	Possible causes/consequences and Solutions
Driver's Door Open & Transmission Not in P Risk of Vehicle Rolling Away	<ul style="list-style-type: none"> * The driver's door is not fully closed and the transmission is in position R, N or D. <ul style="list-style-type: none"> ▶ Switch the transmission to position P when you park the vehicle.
N Permanently Active Risk of Rolling Away	<ul style="list-style-type: none"> * While the vehicle is rolling or while you are driving, you have shifted the transmission to position N. <ul style="list-style-type: none"> ▶ Depress the brake pedal to stop and, when the vehicle is stationary, shift the transmission to position P. ▶ To continue your journey, shift the transmission to position D.
Only Shift to 'P' when Vehicle is Stationary	<ul style="list-style-type: none"> * The transmission can only be shifted to position P when the vehicle is stationary.
Service Required Do Not Shift Gears Visit Dealer	<ul style="list-style-type: none"> * The transmission is malfunctioning. The transmission position can no longer be shifted. <ul style="list-style-type: none"> ▶ When the transmission is in position D, consult a qualified specialist workshop and do not shift the transmission position. ▶ For all other transmission positions, park the vehicle safely. ▶ Consult a qualified specialist workshop or breakdown service.
Transmission Malfunction Stop	<ul style="list-style-type: none"> * The transmission is malfunctioning. The transmission switches to position N automatically. <ul style="list-style-type: none"> ▶ Pull over and stop the vehicle safely as soon as possible, paying attention to road and traffic conditions. ▶ Switch the transmission to position P. ▶ Consult a qualified specialist workshop.
Reversing Not Possible Service Required	<ul style="list-style-type: none"> * The transmission is malfunctioning. Reverse gear can no longer engaged. <ul style="list-style-type: none"> ▶ Consult a qualified specialist workshop.

Display messages	Possible causes/consequences and Solutions
<p>Stop Vehicle Leave Engine Running Wait Transmission Cooling</p>	<p>* The transmission has overheated. Pulling away can be temporarily impaired or not possible.</p> <ul style="list-style-type: none"> ▶ Pull over and stop the vehicle safely as soon as possible, paying attention to road and traffic conditions. Do not continue driving under any circumstances. ▶ Start the engine. ▶ Wait until the display message disappears before pulling away.
<p>Auxiliary Battery Malfunction</p>	<p>* The auxiliary battery for the transmission is no longer being charged.</p> <ul style="list-style-type: none"> ▶ Consult a qualified specialist workshop. ▶ Until then, manually set the transmission to position P before you switch off the engine. ▶ Before leaving the vehicle, apply the electric parking brake.
<div data-bbox="155 550 312 629" data-label="Image"> </div> <p>Steering Malfunction Drive Carefully Service Required</p>	<p>* The power assistance of the steering is malfunctioning. You may need to use more force to steer.</p> <ul style="list-style-type: none"> ▶ Drive on carefully. ▶ Consult a qualified specialist workshop.

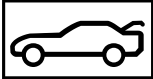

Display messages	Possible causes/consequences and Solutions
 <p data-bbox="195 334 462 410">Steering Malfunction Stop Immediately See Operator's Manual</p>	<p data-bbox="526 239 1299 265">* The steering is malfunctioning. Steering capability is considerably impaired.</p> <div data-bbox="547 282 1696 461" style="border: 1px solid gray; padding: 5px;"> <p data-bbox="565 293 1204 319">⚠ WARNING Risk of accident if steering capability is impaired</p> <p data-bbox="565 332 1461 358">If the steering does not function as intended, the vehicle's operating safety is jeopardized.</p> <ul style="list-style-type: none"> <li data-bbox="565 365 1633 417">▶ Pull over and stop the vehicle safely as soon as possible, paying attention to road and traffic conditions. Do not continue driving under any circumstances. <li data-bbox="565 427 994 453">▶ Consult a qualified specialist workshop. </div> <ul style="list-style-type: none"> <li data-bbox="547 479 1692 531">▶ Pull over and stop the vehicle safely as soon as possible, paying attention to road and traffic conditions. Do not continue driving under any circumstances. <li data-bbox="547 541 975 567">▶ Consult a qualified specialist workshop.
 <p data-bbox="195 673 447 749">Steering Malfunction Increased Physical Effort See Operator's Manual</p>	<p data-bbox="526 578 1095 603">* The power assistance of the steering is malfunctioning.</p> <div data-bbox="547 621 1696 771" style="border: 1px solid gray; padding: 5px;"> <p data-bbox="565 631 1297 657">⚠ WARNING Risk of an accident due to altered steering characteristics</p> <p data-bbox="565 671 1633 697">If the power assistance of the steering fails partially or completely, you will need to use more force to steer.</p> <ul style="list-style-type: none"> <li data-bbox="565 704 1045 730">▶ If safe steering is possible, drive on carefully. <li data-bbox="565 740 1193 766">▶ Visit or consult a qualified specialist workshop immediately. </div> <ul style="list-style-type: none"> <li data-bbox="547 792 1031 818">▶ If safe steering is possible, drive on carefully. <li data-bbox="547 828 1175 854">▶ Visit or consult a qualified specialist workshop immediately.



Display messages	Possible causes/consequences and Solutions
<p>Active Hood Malfunction See Operator's Manual</p>	<ul style="list-style-type: none"> * The active hood (pedestrian protection) is malfunctioning or inoperative after having already been triggered. <ul style="list-style-type: none"> ▶ Consult a qualified specialist workshop.
	<ul style="list-style-type: none"> * The engine hood is open. <div style="border: 1px solid gray; padding: 5px; margin: 5px 0;"> <p>⚠ WARNING Risk of accident if the engine hood is unlatched while driving</p> <p>An unlocked engine hood may open up when the vehicle is in motion and block your view.</p> <ul style="list-style-type: none"> ▶ Never unlatch the engine hood while driving. ▶ Before every trip, ensure that the engine hood is latched. </div> <ul style="list-style-type: none"> ▶ Pull over and stop the vehicle safely as soon as possible, paying attention to road and traffic conditions. ▶ Close the engine hood.
	<ul style="list-style-type: none"> * At least one door is open. <ul style="list-style-type: none"> ▶ Close all the doors.



Display messages	Possible causes/consequences and Solutions
	<p>* The trunk lid is open.</p> <div style="border: 1px solid gray; padding: 5px; margin-top: 10px;"> <p>⚠ WARNING Risk of exhaust gas poisoning</p> <p>Combustion engines emit poisonous exhaust gases such as carbon monoxide. Exhaust gases can enter the vehicle interior if the trunk lid is open when the engine is running, especially if the vehicle is in motion.</p> <ul style="list-style-type: none"> ▶ Always switch off the engine before opening the trunk lid. ▶ Never drive with the trunk lid open. </div> <p>▶ Close the trunk lid.</p>
 <p>Example: Lock Seat Backrest Front Left</p>	<p>* The seat backrest of the corresponding front seat is not engaged.</p> <p>▶ Push the seat backrest back until it engages.</p>
 <p>Example: Rear Left Backrest Not Latched</p>	<p>* The corresponding seat backrest of the rear bench seat is not engaged.</p> <p>▶ Fold the corresponding seat backrest back until it engages.</p>

Display messages	Possible causes/consequences and Solutions
 <p data-bbox="144 332 345 353">Check Washer Fluid</p>	<p data-bbox="473 239 1336 263">* The washer fluid level in the washer fluid reservoir has dropped below the minimum.</p> <ul style="list-style-type: none"> <li data-bbox="493 273 846 297">▶ Add washer fluid (→ page 267).

Lights

Display messages	Possible causes/consequences and Solutions
 <p data-bbox="144 586 395 632">Example: Check Left Low Beam</p>	<p data-bbox="473 493 820 516">* The corresponding bulb is faulty.</p> <ul style="list-style-type: none"> <li data-bbox="493 527 894 551">▶ Visit a qualified specialist workshop. <li data-bbox="493 561 1650 610">ⓘ LED light bulbs: the display message for the corresponding lamp only appears when all the light-emitting diodes in the lamp have failed.
 <p data-bbox="144 743 369 764">Switch On Headlamps</p>	<p data-bbox="473 650 833 674">* You are driving without low beam.</p> <ul style="list-style-type: none"> <li data-bbox="493 684 1033 708">▶ Turn the light switch to the  or AUTO position.

Display messages	Possible causes/consequences and Solutions
 <p data-bbox="195 334 371 360">Switch Off Lights</p>	<p data-bbox="519 241 1123 265">* You are leaving the vehicle and the lights are switched on.</p> <ul style="list-style-type: none"> <li data-bbox="543 275 999 301">▶ Turn the light switch to the AUTO position.
 <p data-bbox="195 466 482 515">Auto Lamp Function Inoperative</p>	<p data-bbox="519 370 796 394">* The light sensor is faulty.</p> <ul style="list-style-type: none"> <li data-bbox="543 405 975 430">▶ Consult a qualified specialist workshop.
 <p data-bbox="195 621 463 697">Adaptive Highbeam Assist Camera View Restricted See Operator's Manual</p>	<p data-bbox="519 526 1040 550">* The camera view is reduced. Possible causes are:</p> <ul style="list-style-type: none"> <li data-bbox="550 560 1101 584">• Dirt on the windshield in the camera's field of vision <li data-bbox="550 594 814 618">• Heavy rain, snow or fog <p data-bbox="543 636 1480 659">Driving systems and driving safety systems may be malfunctioning or temporarily unavailable.</p> <p data-bbox="543 670 1511 694">When the causes no longer apply, driving systems and driving safety systems are available again.</p> <p data-bbox="543 704 972 728">If the display message does not disappear:</p> <ul style="list-style-type: none"> <li data-bbox="543 738 1415 762">▶ Pull over and stop the vehicle safely, paying attention to road and traffic conditions. <li data-bbox="543 772 796 796">▶ Clean the windshield.

Display messages	Possible causes/consequences and Solutions
 <p data-bbox="144 332 412 408">Adaptive Highbeam Assist Currently Unavailable See Operator's Manual</p>	<ul style="list-style-type: none"> <li data-bbox="469 239 1023 298">* Adaptive Highbeam Assist is temporarily unavailable. The system limits have been reached (→ page 112). <li data-bbox="493 308 1646 387">▶ Drive on. When the causes no longer apply, the system will be available again. The Adaptive Highbeam Assist Now Available display message appears.
<p data-bbox="144 422 412 473">Adaptive Highbeam Assist Inoperative</p>	<ul style="list-style-type: none"> <li data-bbox="469 422 938 446">* Adaptive Highbeam Assist is malfunctioning. <li data-bbox="493 456 894 480">▶ Visit a qualified specialist workshop.
 <p data-bbox="144 584 412 635">Active Headlamps Inoperative</p>	<ul style="list-style-type: none"> <li data-bbox="469 491 824 514">* The active light function is faulty. <li data-bbox="493 525 925 549">▶ Consult a qualified specialist workshop.
 <p data-bbox="144 739 384 790">Malfunction See Operator's Manual</p>	<ul style="list-style-type: none"> <li data-bbox="469 646 875 670">* The exterior lighting is malfunctioning. <li data-bbox="493 680 925 704">▶ Consult a qualified specialist workshop.

Warning and indicator lamps

Overview of warning and indicator lamps

Some systems perform a self-test when the ignition is switched on. Some warning and indicator lamps may briefly light up or flash. This behavior is non-critical. These warning and indicator lamps only indicate a malfunction if they light up or flash after the engine is started or during a journey.

Instrument Display (standard)

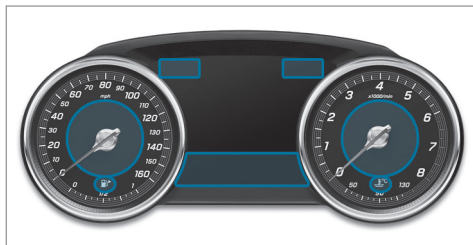

Instrument Display in the Widescreen Cockpit







Progressive setting (Widescreen Cockpit)





















If you select the progressive display setting in vehicles with a Widescreen Cockpit, the position of the indicator lamps in the Instrument Display changes.

Warning and indicator lamps:

-  Low beam
-  Parking lights
-  High beam
-   Turn signal light

380 Display messages and warning/indicator lamps

	Rear fog light		USA: electric parking brake applied (red)		Restraint system
	Seat belt is not fastened		Canada: electric parking brake applied (red)		Engine diagnosis
	USA: brakes		Electric parking brake (yellow)		Fuel reserve with fuel filler cap location indicator
	Canada: brakes (red)		Steering assistance malfunction		Coolant too hot/cold
	ABS malfunction		Electrical malfunction		Distance warning
	ESP®				Tire pressure monitoring system
	ESP® OFF				

Safety systems

Warning/indicator lamp



Brake warning lamp (USA)



Brakes warning lamp (Canada)

Signal type | Possible causes/consequences and Solutions

The red brake system warning lamp is lit while the engine is running.

Possible causes are:

- The brake force boosting is malfunctioning and the braking characteristics may be affected.
- There is not enough brake fluid in the brake fluid reservoir.

⚠ WARNING There is a risk of an accident if brake force boosting is malfunctioning



If brake force boosting is malfunctioning, the wheels may lock when braking. Braking characteristics may be impaired. The braking distance in an emergency braking situation can increase.



- ▶ Pull over and stop the vehicle safely as soon as possible, paying attention to road and traffic conditions. Do not continue driving under any circumstances.
- ▶ Consult a qualified specialist workshop.

⚠ WARNING Risk of an accident due to low brake fluid level



If the brake fluid level is too low, the braking effect and the braking characteristics may be impaired.

- ▶ Pull over and stop the vehicle safely as soon as possible, paying attention to road and traffic conditions. Do not continue driving under any circumstances.
- ▶ Consult a qualified specialist workshop.
Do not add brake fluid.

Warning/indicator lamp	Signal type Possible causes/consequences and Solutions
	<ul style="list-style-type: none"> ▶ Pull over and stop the vehicle safely as soon as possible, paying attention to road and traffic conditions. Do not continue driving under any circumstances. ▶ Observe the messages in the multifunction display. ▶ Consult a qualified specialist workshop. <p>USA only: if an additional display message appears with the  symbol in the multifunction display, the brake linings have reached their wear limit.</p> <ul style="list-style-type: none"> ▶ Visit a qualified specialist workshop.
 <p>ESP® warning lamp</p>	<p>The yellow ESP® warning lamp is lit while the engine is running. ESP® is malfunctioning. Other driving systems and driving safety systems may also malfunction.</p> <div style="background-color: #f0f0f0; padding: 5px; border: 1px solid #ccc;"> <p>▲ WARNING Risk of skidding if ESP is malfunctioning®</p> <p>If ESP® is malfunctioning, ESP® cannot carry out vehicle stabilization. In addition, other driving safety systems are switched off.</p> <ul style="list-style-type: none"> ▶ Drive on carefully. ▶ Have ESP® checked at a qualified specialist workshop. </div> <ul style="list-style-type: none"> ▶ Drive on carefully. ▶ Observe the messages in the multifunction display. ▶ Consult a qualified specialist workshop.



Warning/indicator lamp	Signal type Possible causes/consequences and Solutions
 <p>Red electric parking brake indicator lamp (USA only)</p>  <p>Red indicator lamp electric parking brake (Canada only)</p>  <p>Yellow electric parking brake indicator lamp is malfunctioning</p>	<p>The red electric parking brake indicator lamp flashes or is lit. The yellow indicator lamp is also lit if the electric parking brake malfunctions.</p> <ul style="list-style-type: none">▶ Observe the messages in the multifunction display.



Warning/indicator lamp	Signal type Possible causes/consequences and Solutions
<div data-bbox="155 242 312 325" data-label="Image"> </div> <p data-bbox="144 332 402 381">Restraint system warning lamp</p>	<p data-bbox="452 239 1166 298">The red restraint system warning lamp is lit while the engine is running. The restraint system is malfunctioning.</p> <div data-bbox="452 319 1652 487" data-label="Complex-Block" style="border: 1px solid gray; padding: 5px;"> <p data-bbox="467 325 1345 350">⚠ WARNING Risk of injury or fatal injury due to a malfunction in the restraint system</p> <p data-bbox="467 366 1633 443">If the restraint system is malfunctioning, restraint system components may be triggered unintentionally or might not be triggered at all in the event of an accident. This may affect the Emergency Tensioning Device or airbag, for example.</p> <ul style="list-style-type: none"> <li data-bbox="467 453 1461 478">▶ Have the restraint system checked and repaired immediately at a qualified specialist workshop. </div> <ul style="list-style-type: none"> <li data-bbox="452 505 670 530">▶ Drive on carefully. <li data-bbox="452 540 999 565">▶ Observe the messages in the multifunction display. <li data-bbox="452 576 1014 600">▶ Consult a qualified specialist workshop immediately.

Warning/indicator lamp	Signal type Possible causes/consequences and Solutions
 <p data-bbox="195 334 380 357">ABS warning lamp</p>	<p data-bbox="504 241 1129 367">The yellow ABS warning lamp is lit while the engine is running. ABS is malfunctioning. If there is an additional warning tone, EBD is malfunctioning. Other driving and driving safety systems may also be faulty.</p> <div data-bbox="504 386 1700 424" style="background-color: #e0e0e0; padding: 5px;"> <p data-bbox="504 394 1236 420">▲ WARNING There is risk of skidding if EBD or ABS is malfunctioning</p> </div> <p data-bbox="504 436 1637 521">If EBD or ABS is malfunctioning, the wheels could lock when braking. The steering capability and braking characteristics are thus severely impaired. The braking distance in an emergency braking situation can increase. In addition, other driving safety systems are switched off.</p> <ul style="list-style-type: none"> <li data-bbox="504 531 741 554">▶ Drive on carefully. <li data-bbox="504 564 1350 587">▶ Have the brake system checked immediately at a qualified specialist workshop. <ul style="list-style-type: none"> <li data-bbox="504 617 722 640">▶ Drive on carefully. <li data-bbox="504 650 1051 673">▶ Observe the messages in the multifunction display. <li data-bbox="504 683 907 706">▶ Visit a qualified specialist workshop.
 <p data-bbox="195 816 393 839">ESP® warning lamp</p>	<p data-bbox="504 725 1190 788">The yellow ESP® warning lamp flashes while the vehicle is in motion. ESP® is intervening (→ page 148).</p> <ul style="list-style-type: none"> <li data-bbox="504 798 1184 821">▶ Adapt your driving style to suit the road and weather conditions.

Warning/indicator lamp	Signal type Possible causes/consequences and Solutions
 <p data-bbox="144 335 389 360">ESP® OFF warning lamp</p>	<p data-bbox="452 242 1134 302">The yellow ESP® OFF warning lamp is lit while the engine is running. ESP® is deactivated.</p> <p data-bbox="467 332 1151 360">⚠ WARNING Risk of skidding when driving with ESP® deactivated</p> <p data-bbox="467 376 1618 425">If ESP® is deactivated, ESP® cannot carry out vehicle stabilization. The availability of further driving safety systems is also limited.</p> <ul data-bbox="467 438 1088 498" style="list-style-type: none"><li data-bbox="467 438 687 462">▶ Drive on carefully.<li data-bbox="467 474 1088 498">▶ Only deactivate ESP® for as long as the situation requires. <p data-bbox="467 526 996 550">If ESP® cannot be activated, ESP® is malfunctioning.</p> <ul data-bbox="467 562 1179 586" style="list-style-type: none"><li data-bbox="467 562 1179 586">▶ Have ESP® checked immediately at a qualified specialist workshop. <p data-bbox="452 619 1040 643">▶ Observe the notes on deactivating ESP® (→ page 148).</p>

Seat belts



Warning/indicator lamp	Signal type Possible causes/consequences and Solutions
 <p data-bbox="195 373 426 397">Seat belt warning lamp</p>	<p data-bbox="504 280 1308 304">After starting the engine, the red seat belt warning lamp lights up for 6 seconds.</p> <p data-bbox="504 314 996 338">In addition, an acoustic warning tone may sound.</p> <p data-bbox="504 349 1424 372">The seat belt warning lamp reminds the driver and front passenger to fasten their seat belts.</p> <ul style="list-style-type: none"> <li data-bbox="504 383 888 407">▶ Fasten your seat belt (→ page 35). <p data-bbox="504 425 1356 449">If you have placed objects on the front passenger seat, the warning lamp may stay lit.</p>
 <p data-bbox="195 556 426 580">Seat belt warning lamp</p>	<p data-bbox="504 464 1308 487">The red seat belt warning lamp flashes and an intermittent warning tone sounds.</p> <p data-bbox="504 498 1411 522">The driver or front passenger has not fastened their seat belt while the engine is in motion.</p> <ul style="list-style-type: none"> <li data-bbox="504 532 888 556">▶ Fasten your seat belt (→ page 35). <li data-bbox="504 566 968 590">▶ There are objects on the front passenger seat. <li data-bbox="504 600 1049 624">▶ Remove the objects from the front passenger seat.

Warning/indicator lamp	Signal type Possible causes/consequences and Solutions
 <p data-bbox="144 332 375 356">Distance warning lamp</p>	<p data-bbox="454 239 1155 263">The red distance warning lamp lights up while the vehicle is in motion.</p> <p data-bbox="454 273 1155 297">The distance to the vehicle in front is too small for the speed selected.</p> <p data-bbox="454 307 1360 331">If there is an additional warning tone, you are approaching an obstacle at too high a speed.</p> <ul data-bbox="454 341 833 400" style="list-style-type: none"><li data-bbox="454 341 833 365">▶ Be prepared to brake immediately.<li data-bbox="454 376 709 399">▶ Increase the distance. <p data-bbox="454 418 790 442">Active Brake Assist (→ page 151).</p>
 <p data-bbox="144 626 375 675">Power steering system warning lamp</p>	<p data-bbox="454 532 1228 556">The red power steering system warning lamp is lit while the engine is running.</p> <p data-bbox="454 566 1147 590">The power steering assistance or the steering itself is malfunctioning.</p> <div data-bbox="454 612 1646 790" style="border: 1px solid gray; padding: 5px;"><p data-bbox="469 619 1114 643">⚠ WARNING Risk of accident if steering capability is impaired</p><p data-bbox="469 660 1369 684">If the steering does not function as intended, the vehicle's operating safety is jeopardized.</p><ul data-bbox="469 695 1578 780" style="list-style-type: none"><li data-bbox="469 695 1578 743">▶ Pull over and stop the vehicle safely as soon as possible, paying attention to road and traffic conditions. Do not continue driving under any circumstances.<li data-bbox="469 754 903 778">▶ Consult a qualified specialist workshop.</div> <p data-bbox="454 806 999 829">▶ Observe the messages in the multifunction display.</p>

Engine

Warning/indicator lamp	Signal type Possible causes/consequences and Solutions
 <p data-bbox="195 373 452 422">Engine diagnosis warning lamp</p>	<p data-bbox="504 280 1252 306">The yellow engine diagnosis warning lamp is lit while the engine is running.</p> <p data-bbox="504 314 1313 340">A malfunction has occurred in the engine, the exhaust system or the fuel system.</p> <p data-bbox="504 349 1572 375">The emissions limit values may be exceeded and the engine may be running in emergency operation mode.</p> <p data-bbox="504 383 1692 436">In some states, legal requirements stipulate that you must immediately consult a qualified specialist workshop as soon as the yellow engine diagnosis warning lamp lights up.</p> <ul data-bbox="504 444 1341 470" style="list-style-type: none"><li data-bbox="504 444 1341 470">▶ Have the vehicle checked as soon as possible at a qualified specialist workshop.

Warning/indicator lamp	Signal type Possible causes/consequences and Solutions
<div data-bbox="153 244 312 329" data-label="Image"> </div> <p data-bbox="144 334 365 358">Coolant warning lamp</p>	<p data-bbox="454 241 1079 265">The red coolant warning lamp is lit while the engine is running.</p> <p data-bbox="454 275 657 299">Possible causes are:</p> <ul data-bbox="454 310 916 438" style="list-style-type: none"> • The temperature sensor is malfunctioning • The coolant level is too low • The air supply to the radiator is obstructed • The radiator fan is faulty <p data-bbox="454 456 1393 480">If there is an additional warning tone, the coolant temperature has exceeded 248 °F (120 °C).</p> <div data-bbox="454 498 1659 677" style="border: 1px solid gray; padding: 5px;"> <p data-bbox="463 508 1105 532">⚠ WARNING Danger of burns when opening the engine hood</p> <p data-bbox="463 547 1628 598">If you open the engine hood when the engine has overheated or during a fire in the engine compartment, you could come into contact with hot gases or other escaping operating fluids.</p> <ul data-bbox="463 609 1535 667" style="list-style-type: none"> ▶ Before opening the engine hood, allow the engine to cool down. ▶ In the event of a fire in the engine compartment, keep the engine hood closed and call the fire service. </div> <ul data-bbox="454 695 1622 781" style="list-style-type: none"> ▶ Pull over and stop the vehicle safely and switch off the engine, paying attention to road and traffic conditions. Do not continue driving under any circumstances. ▶ Observe the messages in the multifunction display. <p data-bbox="454 806 1245 829">If the coolant temperature display is at the lower end of the temperature scale:</p> <ul data-bbox="454 840 888 864" style="list-style-type: none"> ▶ Consult a qualified specialist workshop.

Warning/indicator lamp	Signal type Possible causes/consequences and Solutions
	<p>Otherwise:</p> <ul style="list-style-type: none"> ▶ Leave the vehicle and keep a safe distance from the vehicle until the engine has cooled down. ▶ Check the coolant level (→ page 266). ▶ Make sure that the air supply to the radiator is not obstructed. ▶ Avoiding high loads on the engine, drive on to the nearest qualified specialist workshop. In doing so, ensure that the coolant temperature display remains below 248 °F (120 °C).
 <p>Fuel reserve warning lamp</p>	<p>The yellow fuel reserve warning lamp lights up while driving.</p> <p>There has been pressure loss in the fuel system. The fuel filler cap is not closed correctly or the fuel system is leaking.</p> <ul style="list-style-type: none"> ▶ Close the fuel filler cap. ▶ If the fuel filler cap was already properly closed: consult a qualified specialist workshop.
 <p>Fuel reserve warning lamp</p>	<p>The yellow fuel reserve warning lamp is lit while the engine is running.</p> <p>The fuel level has dropped into the reserve range.</p> <ul style="list-style-type: none"> ▶ Refuel.

Tires

Warning/indicator lamp	Signal type Possible causes/consequences and Solutions
 <p data-bbox="144 373 395 422">Tire pressure monitoring system warning lamp</p>	<p data-bbox="452 280 1404 339">The yellow tire pressure monitoring system warning lamp (pressure loss/malfunction) is lit. The tire pressure monitoring system has detected a loss of pressure in at least one of the tires.</p> <div data-bbox="452 356 1646 655" style="border: 1px solid gray; padding: 5px;"> <p data-bbox="465 366 1142 391">⚠ WARNING Risk of an accident due to insufficient tire pressure</p> <p data-bbox="465 408 1057 433">Tire pressures that are too low pose the following hazards:</p> <ul data-bbox="476 443 1378 536" style="list-style-type: none"> <li data-bbox="476 443 1212 468">• The tires may burst, especially as the load and vehicle speed increase. <li data-bbox="476 478 1378 503">• The tires may wear excessively and/or unevenly, which may greatly impair tire traction. <li data-bbox="476 513 1352 536">• The driving characteristics, as well as steering and braking, may be greatly impaired. <p data-bbox="465 553 894 578">You could then lose control of the vehicle.</p> <ul data-bbox="465 588 920 646" style="list-style-type: none"> <li data-bbox="465 588 920 613">▶ Observe the recommended tire pressure. <li data-bbox="465 623 875 646">▶ Adjust the tire pressure if necessary. </div> <ul data-bbox="452 673 1130 733" style="list-style-type: none"> <li data-bbox="452 673 1130 698">▶ Stop the vehicle, paying attention to road and traffic conditions. <li data-bbox="452 708 864 733">▶ Check the tire pressure and the tires.

Warning/indicator lamp	Signal type Possible causes/consequences and Solutions
 <p data-bbox="195 334 445 384">Tire pressure monitoring system warning lamp</p>	<p data-bbox="504 241 1665 291">The yellow tire pressure monitoring system warning lamp (pressure loss/malfunction) flashes for approximately one minute and then remains lit.</p> <p data-bbox="504 303 1049 327">The tire pressure monitoring system is malfunctioning.</p> <div data-bbox="504 344 1702 523" style="border: 1px solid gray; padding: 5px;"><p data-bbox="519 353 1530 377">⚠ WARNING There is a risk of an accident if the tire pressure monitoring system is malfunctioning</p><p data-bbox="519 392 1665 442">If the tire pressure monitoring system is malfunctioning, it is not able to issue a warning if there is pressure loss in one or more of the tires.</p><p data-bbox="519 454 1448 478">Underinflated tires may, for example, impair the driving, steering and braking characteristics.</p><ul data-bbox="519 491 1406 514" style="list-style-type: none"><li data-bbox="519 491 1406 514">▶ Have the tire pressure monitoring system checked at a qualified specialist workshop.</div> <p data-bbox="504 541 907 565">▶ Visit a qualified specialist workshop.</p>

1, 2, 3 ...

12 -V battery-

Charging	285
Notes	283
Starting assistance	285

360° camera	175
Care	271
Function/notes	175
Selecting a view	177

A**A/C function**

Activating/deactivating (control panel)	121
---	-----

ABS (Anti-lock Braking System)	147
---	-----

Acceleration

see Kickdown

Access data

Editing	235
Setting	234

Acoustic locking verification signal

Switching on/off	56
------------------------	----

Active Blind Spot Assist

Brake application	184
Function/notes	184
System limitations	184

Active Brake Assist

Driving safety system	151
Setting	155

Active Emergency Stop Assist

164

Active hood (pedestrian protection)

262

Method of operation	262
Resetting	262

Active Lane Change Assist

164

Active Lane Keeping Assist

Function/notes	186
Sensitivity	189
Setting the sensitivity	189
Switching on/off	188
System limitations	186

Adaptive cruise control

see Driving system

Adaptive Damping System

167

Adaptive Highbeam Assist

Function/notes	112
----------------------	-----

Switching on/off	113
------------------------	-----

Added substances (fuel)

see Fuel

Additives

330

Engine oil	330
------------------	-----

Additives (engine oil)

see Additives

Address book

see Contacts

Adjustable damping

See Adaptive Damping System	167
-----------------------------------	-----

Suspension	167
------------------	-----

Adjusting the balance/fader

Burmester® high-end 3D surround sound system	260
Burmester® surround sound system	259

Adjusting the sound focus

Burmester® surround sound system	259
---------------------------------------	-----

Adjusting the sound optimization

Burmester® high-end 3D surround sound system	260
--	-----































- Adjusting the treble, mid-range and bass**
 Burmester® high-end 3D surround sound system 260
 Burmester® surround sound system 259
- Air bag**
 Activation 31
- AIR BODY CONTROL**
 Setting 169
 Suspension 167
- Air conditioning system**
 see Climate control
- Air distribution** 121
- Air freshener system**
 see Fragrance system
- Air vents** 124
 Adjusting (front) 124
 Adjusting (rear passenger compartment) 125
 Glove box 125
- Air vents**
 see Air vents
- Air-recirculation mode** 122
- Airbag**
 Belt airbag 35
 Front airbag 37
 Installation locations 37
 Knee airbag 37
 Overview 37
 Protection 38
 Reduced protection 39
 Side airbag 37
 Window airbag 37
- Airflow** 121
- AIRPANEL (Care)** 271
- Alarm**
 see Panic alarm
- Alarm system**
 see Anti-theft protection
- Ambient lighting** 115
- Android Auto®**
 Connecting a mobile phone 229
 Ending 230
 Overview 229
 Tone settings 230
- Anti-theft protection** 79
 ATA (Anti-Theft Alarm system) 79
 Deactivating the alarm (ATA) 80
 Immobilizer 79
- Apple CarPlay®**
 Connecting an iPhone® 228
 Ending 229
 Overview 228
 Tone settings 229
- Ashtray**
 Front center console 104
 Rear passenger compartment 105
- Assistance graphic**
 Menu (on-board computer) 194
- ASSYST PLUS** 261
 Battery disconnection periods 262
 Displaying the service due date 261
 Regular service work 261
 Special service requirements 261
- ASSYST PLUS service interval display** 261
- ATA (Anti-Theft Alarm system)**
 Deactivating the alarm 80
 Function 79





















- ATTENTION ASSIST**
 Function/notes 182
 Switching on/off 184
 System limitations 182
- Attention assistant**
 see Driving system
- Audio mode**
 Activating media mode 241
 Connecting USB devices 243
 Copyright 240
 Information 239
 Inserting/removing SD memory card ... 241
 Media search 246
 Overview 242
 Pause and playback function 243
 Selecting a track 243
 Selecting playback options 243
 Track list 243
- Authorized Mercedes-Benz service center**
 see Qualified specialist workshop
- Automatic car wash (care)** 268
- Automatic distance control**
 see Driving system
- Automatic driving lights** 111
- Automatic engine start (ECO start/stop function)** 132
- Automatic engine stop (ECO start/stop function)** 132
- Automatic front passenger airbag shutoff**
 see Front passenger airbag shutoff
- Automatic mirror folding function**
 Switching on/off 120
- Automatic transmission**
 DIRECT SELECT selector lever 134
 Drive program display 134
 Drive programs 133
 DYNAMIC SELECT switch 133
 Function 136
 Gearshift recommendation 137
 Kickdown 138
 Transmission position display 134
 Transmission positions 134
- B**
- BAS (Brake Assist System)**
 Driving safety system 147
- Battery**
 Key 57
- Battery (12 V)**
 Charging 285
 Notes 283
 Starting assistance 285
- Belt**
 see Seat belts
- Belt air bag**
 Activation 31
- Belt airbag** 35
- Blind Spot Assist**
 Activating/deactivating 186
 Function/notes 184
 System limitations 184
- Blower**
 see Climate control
- Bluetooth®**
 Activating/deactivating 211
 Settings 211
- Bluetooth® Audio**
 Activating 250

- De-authorizing (de-registering) the device 252
- Information 249
- Overview 251
- Searching for and authorizing the device 249
- Brake fluid**
 - Notes 331
- Brakes**
 - HOLD function 166
- Breakdown**
 - Changing a wheel 319
 - Flat tire 278
 - Overview of the help functions 16
 - Roadside Assistance 21
 - Tow starting 291
 - Towing away 288
 - Transporting the vehicle 290
- Burmester® high-end 3D surround sound system**
 - Adjusting the balance/fader 260
 - Adjusting the sound optimization 260
 - Adjusting the treble, mid-range and bass 260
 - Calls up the sound menu 260
 - Information 260
 - Setting the sound profile 260
- Burmester® surround sound system**
 - Adjusting the balance/fader 259
 - Adjusting the sound focus 259
 - Adjusting the treble, mid-range and bass 259
 - Calls up the sound menu 259
 - Information 259
 - Switching the surround sound on/off .. 259
- Buttons**
 - Multifunction steering wheel 191
- C**
- Calculating a route**
 - Navigation 218
- California**
 - Important information for private customers and lessees 22
- Call list**
 - Deleting 227
 - Making a call 226
 - Options in the call list 227
- Overview 226
- Calls**
 - Accepting 223
 - Calls with several participants 224
 - Declining 223
 - Ending a call 223
 - Incoming call during an existing call 224
 - Making 223
- Calls up the sound menu**
 - Burmester® high-end 3D surround sound system 260
 - Burmester® surround sound system 259
- Camera**
 - Assigning as a favorite 177
- Car key**
 - see Key
- Car wash**
 - see Care
- Care** 273
 - AIRPANEL 271
 - Car wash 268
 - Carpet 273
 - Display 273
 - EASY-PACK trunk box 273

- Exterior lighting 271
Genuine wood/trim 273
Matt finish 270
Paint 270
Plastic trim 273
Power washer 268
Reversing camera/360° Camera 271
Roof lining 273
Seat belts 273
Seat cover 273
Sensors 271
Tailpipes 271
Trailer hitch 271
Washing by hand 269
Wheels/rims 271
Windows 271
Wiper blades 271
- Carpet (Care)** 273
- Change of address** 21
- Change of ownership** 21
- Changing a wheel** 319
- Charging**
12 -V battery- 285
- Child safety lock**
Rear door 52
Rear side windows 53
- Child seat**
Front passenger seat (notes) 51
Front passenger seat (rearward-facing/forward-facing) 52
LATCH-type (ISOFIX) (installing) 49
LATCH-type (ISOFIX) (notes) 48
Top Tether 50
- Child seat safety feature** 47
- Children**
Child seat safety feature 47
Restraint systems 45
- Cigarette lighter** 105
- Cleaning**
see Care
- Climate control** 121
Activating/deactivating 121
Activating/deactivating the A/C function (control panel) 121
Activating/deactivating the synchronization function (control panel) 122
Adjusting air vents 124
- Air distribution settings 122
Air-recirculation mode 122
Automatic control 121
Defrosting the windows 122
Defrosts the windshield 121
Dual-zone automatic climate control panel 121
Fragrance system 122
Ionization 122
PAG oil capacity 333
Refrigerant 333
Refrigerant filling capacity 333
Sets the airflow 121
Setting the air distribution 121
Setting the temperature 121
Switching the rear window heater on/off 121
Windshield heater 124
- Cockpit** 6
Overview 6
- Connection status**
Displays 236
Overview 236
- Contacts** 224
Calling up 225

- Deleting 226
- Downloading (from mobile phone) 224
- Importing 225
- Information 224
- Making a call 226
- Name format 225
- Options 226
- Saving 226
- Controller**
 - Operating 203
- Convenience closing** 72
- Convenience opening** 71
- Coolant (engine)**
 - Checking level 266
 - Filling capacity 331
 - Notes 331
- Cooling**
 - see Climate control
- Copyright** 28
- Cornering light function** 112
- Crosswind Assist** 151
 - ESP® (Electronic Stability Program) 151
- Cruise control**
 - Activating 156
 - Calling up a speed 156
 - Deactivating 156
 - Function/notes 156
 - Lever 156
 - Prerequisites 156
 - Selecting 156
 - Setting a speed 156
 - Storing a speed 156
 - System limitations 156
- Cup holder** 103
 - Installing/removing (center console) ... 103
 - Rear passenger compartment 104
- Cup holder**
 - see Cup holder
- Customer Assistance Center (CAC)** 25
- Customer Relations Department** 25
- D**
- Dashboard**
 - see Cockpit
- Data**
 - Importing/exporting 215
 - Notes on data import/export 215
 - PIN protection for data export 215
- Data acquisition**
 - Vehicle 26
- Daytime running lights** 114
 - Activating/deactivating 114
- Daytime running lights mode**
 - see Daytime running lights
- Deactivating the alarm (ATA)** 80
- Declaration of Conformity**
 - Wireless vehicle components 23
- Definitions (tires and loading)** 313
- Diagnostics connection** 24
- Diesel** 138
- Digital Operator's Manual** 18
- Digital speedometer** 195
- DIRECT SELECT selector lever** 134
 - Engaging drive position 136
 - Engaging park position automatically ... 136
 - Engaging reverse gear 136
 - Function 134
 - Selecting park position 136

- Shifting to neutral 136
- Display**
- Care 273
 - Settings (multimedia system) 210
- Display (on-board computer)** 193
- Display content**
- Menu (on-board computer) 199
- Display message** 336
- Calling up (on-board computer) 336
 - Notes 336
- Display messages**
-  359, 361, 374, 375
 -  Active Headlamps Inoperative 378
 -  Adaptive Highbeam Assist Camera View Restricted See Operator's Manual 377
 -  Adaptive Highbeam Assist Currently Unavailable See Operator's Manual 378
 -  ATTENTION ASSIST Inoperative ... 353
 -  ATTENTION ASSIST: Take a Break! 353
 -  Auto Lamp Function Inoperative ... 377
 -  BRAKE Check Brake Fluid Level 342
 -  Check Engine Oil At Next Refueling 364
 -  Check Tires 365
 -  Check Washer Fluid 376
 -  Compressor Is Cooling 355
 -  Coolant Too Hot Stop Vehicle Turn Engine Off 361
 -  Currently Unavailable See Operator's Manual 337, 340
 -  Don't Forget Your Key 369
 -  Drive More Slowly 354
 -  Example: Check Left Low Beam .. 376
 -  Example: Front Left Malfunction Service Required 350
 -  Example: Left Side Curtain Airbag Malfunction Service Required 350
 -  Example: Lock Seat Backrest Front Left 375
 -  Example: Rear Left Backrest Not Latched 375
 -  Fuel Level Low 364
 -  Gas Cap Loose 364
 -  Inoperative 351
 -  Inoperative See Operator's Manual 338, 339, 341
 -  Key Not Detected (red display message) 369
 -  Key Not Detected (white display message) 369
 -  Malfunction See Operator's Manual 355
 -  Malfunction See Operator's Manual 378
 -  Obtain a New Key 370
 -  HOLD Off 353

- | | | |
|--|---|--|
|  Parking Brake See Operator's Manual 346 |  Stop Vehicle Leave Engine Running 363 | Lever 160 |
|  Place the Key in the Marked Space See Operator's Manual 368 |  Stop vehicle See Operator's Manual 363 | Setting a speed 160 |
|  Please Correct Tire Pressure 366 |  Stop Vehicle Vehicle Too Low 354 | Storing a speed 160 |
|  Please Release Parking Brake 345 |  Switch Off Lights 377 | System limitations 158 |
|  Replace Key Battery 370 |  Switch On Headlamps 376 | Door |
|  See Operator's Manual 362 |  Turn On the Ignition to Release the Parking Brake 345 | Locking (emergency key) 63 |
|  SRS Malfunction Service Required 349 |  Vehicle Rising 355 | Opening (from inside) 59 |
|  Start Engine See Operator's Manual 362 |  Vehicle Rising Please Wait 353 | Unlocking (emergency key) 63 |
|  Steering Malfunction Drive Carefully Service Required 372 |  Warning Tire Malfunction 366 | Unlocking (from inside) 59 |
|  Steering Malfunction Increased Physical Effort See Operator's Manual 373 |  Wheel Sensor(s) Missing 368 | Door control panel 14 |
|  Steering Malfunction Stop Immediately See Operator's Manual 373 | Distance control
see Driving system | DOT, Tire Identification Number (TIN) 309 |
| | Distance Pilot DISTRONIC | Drinking and driving 130 |
| | Activating 160 | Drive position |
| | Activation conditions 160 | Selecting 136 |
| | Calling up a speed 160 | Drive program display 134 |
| | Deactivating 160 | Drive programs 133 |
| | Function/notes 158 | Driver's seat
see Seat |
| | | Driving light
see Automatic driving lights |
| | | Driving safety system
ABS (Anti-lock Braking System) 147 |

- | | | | | | |
|--|-------------------------|--|-----|--|---------------|
| Active Brake Assist | 151 | Driving systems | | Easy entry feature | |
| BAS (Brake Assist System) | 147 | Responsibility | 146 | Operation/notes | 92 |
| Crosswind Assist | 151 | Driving systems overview | 146 | Easy exit feature | |
| EBD (Electronic Brake force Distribu-
tion) | 151 | Driving tips | | Operation/notes | 92 |
| ESP® (Electronic Stability Program) | 148 | Drinking and driving | 130 | EASY-PACK trunk box | 101 |
| ESP® (Electronic Stability Program) | | General driving tips | 130 | Adjusting the height to any position | 99 |
| Crosswind Assist | 151 | Notes on breaking-in a new vehicle | 129 | Care | 273 |
| Setting Active Brake Assist | 155 | Drowsiness detection | | Installing/removing | 101 |
| Driving safety systems overview | 146 | see Driving system | | EBD (Electronic Brake force Distribu-
tion) | 151 |
| Driving system | 156, 158, 170, 178, 182 | Dynamic multicontour seat | | ECO display | |
| 360° camera | 175 | Setting | 87 | Function | 133 |
| Active Blind Spot Assist | 184 | DYNAMIC SELECT | | Resetting | 196 |
| Active Lane Keeping Assist | 186 | Configuring drive program I | 134 | ECO start/stop function | 132 |
| ATTENTION ASSIST | 182 | Displaying engine data | 134 | Automatic engine start | 132 |
| Blind Spot Assist | 184 | Displaying vehicle data | 134 | Automatic engine stop | 132 |
| Cruise control | 156 | Drive program display | 134 | Operation | 132 |
| Distance Pilot DISTRONIC | 158 | Drive programs | 133 | Switching off/on | 132 |
| HOLD function | 166 | Function | 133 | Electric parking brake | 143, 144, 145 |
| Parking Pilot | 178 | Operating (DYNAMIC SELECT switch) ... | 134 | Applying automatically | 143 |
| PARKTRONIC | 170 | | | Applying or releasing manually | 145 |
| Rear view camera | 172 | E | | Emergency braking | 145 |
| Speed Limit Pilot | 158 | Easy entry and exit feature | | Releasing automatically | 144 |
| Steering Pilot | 163 | Setting | 93 | | |

- Electrical fuses**
 - see Fuses
 - Emergency**
 - First-aid kit (soft sided) 277
 - Overview of the help functions 16
 - Safety vest 276
 - Emergency braking** 145
 - Emergency engine start** 291
 - Emergency key**
 - Inserting/removing 57
 - Locking a door 63
 - Unlocking a door 63
 - Emergency operation mode**
 - Starting vehicle 129
 - Emergency release**
 - Trunk lid (from inside) 68
 - Emergency Tensioning Devices**
 - Activation 31
 - Energy consumption**
 - Key 56
 - Engine**
 - ECO start/stop function 132
 - Engine number 326
 - Starting (emergency operation mode) .. 129
 - Starting (mobile phone) 128
 - Starting (smartphone) 128
 - Starting (start/stop button) 127
 - Starting assistance 285
 - Switching off (start/stop button) 139
 - Engine data**
 - Displaying 134
 - Engine hood**
 - Opening/closing 262
 - Engine number** 326
 - Engine oil** 265
 - Additives 330
 - Capacity 330
 - Checking the oil level using the oil dipstick 265
 - MB-Freigabe or MB-Approval 330
 - Topping up 265
 - Entering a destination**
 - Navigation 218
 - Entering characters**
 - On the controller 208
 - On the touchpad 209
 - ESP® (Electronic Stability Program)** 148
 - Activating/deactivating 151
 - Crosswind Assist 151
 - ESP® (Electronic Stability Program) Crosswind Assist** 151
 - Exterior lighting**
 - see Lights
 - Exterior lighting (Care)** 271
 - Eyeglasses box** 96
- F**
- Favorites**
 - Adding 206
 - Calling up 206
 - Deleting 207
 - Moving 207
 - Overview 205
 - Renaming 206
 - First-aid kit (soft sided)** 277
 - Flat tire**
 - Changing a wheel 319
 - MOExtended tires 278
 - Notes 278

- | | | | |
|---|-----|--|-----|
| TIREFIT kit | 279 | Fuel | 330 |
| Floor mats | 109 | Additives | 330 |
| Fragrance | | Consumption | 330 |
| see Fragrance system | | E10 | 329 |
| Fragrance system | 123 | Gasoline | 329 |
| Inserting/removing a flacon | 123 | Quality (gasoline) | 329 |
| Setting | 122 | Reserve fuel level | 330 |
| Frequencies | | Sulfur content | 329 |
| Two-way radios | 324 | Tank capacity | 330 |
| Frequency band | | Fuel consumption | |
| Dial (on-board computer) | 197 | On-board computer | 195 |
| Front airbag | 37 | Fuse insert | |
| Front passenger airbag shutoff | 39 | see Fuses | |
| PASSENGER AIR BAG indicator lamp | 41 | Fuses | 292 |
| Points to remember when the front | | Assignment diagram | 292 |
| passenger seat is occupied | 39 | Before changing | 292 |
| Status display | 41 | Cockpit fuse box | 294 |
| Front passenger seat | | Fuse box in the engine compartment ... | 292 |
| see Seat | | Fuse box in the front-passenger foot- | |
| Front seats massage program | | well | 294 |
| Selecting | 89 | Fuse box in the trunk | 294 |
| | | Notes | 292 |
-
- | | |
|--|-----|
| G | |
| Garage door opener | |
| Clearing the memory | 143 |
| Opening or closing the garage door | 142 |
| Programming buttons | 140 |
| Resolving problems | 142 |
| Synchronizing the rolling code | 142 |
| Gasoline | 138 |
| Gearshift recommendation | 137 |
| Genuine parts | 19 |
| Genuine wood (Care) | 273 |
| Glove box | |
| Air vent | 125 |
| Glove compartment | |
| Locking/unlocking | 96 |
-
- | | |
|---|-----|
| H | |
| Handbrake | |
| see Electric parking brake | |
| Handling characteristics (unusual) | 295 |
| HANDS-FREE ACCESS | 66 |
| Hazard warning lights | 112 |

- Head restraint**
 Front (adjusting manually) 85
 Front (luxury head restraint) 86
 Rear passenger compartment (adjusting) 87
 Rear passenger compartment (removing/installing) 87
- Head-up display**
 Activating/deactivating 201
 Function 200
 Menu (on-board computer) 199
 Setting display elements (on-board computer) 199
 Setting the brightness (on-board computer) 199
 Setting the position (on-board computer) 199
 Using the memory function 93
- Headlamp flashing** 111
- Heating**
 see Climate control
 see Windshield heater
- High beam**
 Activating/deactivating 111
- Adaptive Highbeam Assist 112
- High-pressure cleaning equipment (care)** 268
- Hill start assist** 129
- HOLD function**
 Activating/deactivating 166
 Function/notes 166
- I**
- Identification plate**
 Engine 326
 Refrigerant 333
 Vehicle 326
- Identification plate**
 see Vehicle identification plate
- Ignition**
 Switching on (start/stop button) 126
- Immobilizer** 79
- Indicator lamp**
 see Warning and indicator lamps
- Individual drive program**
 Configuring 134
 Selecting 134
- Information**
 Audio mode 239
 Bluetooth® Audio 249
 Burmester® high-end 3D surround sound system 260
 Burmester® surround sound system 259
 Media Interface 246
 Satellite radio 255
 Software update 217
 Sound settings 258
- Instrument cluster**
 see Instrument display
- Instrument display** 190
 Lighting 193
 Overview 190
 Warning and indicator lamps 379
 Warning and indicator lamps (overview) ... 8
- Instrument lighting** 193
- Interior lighting** 114
 Ambient lighting 115
 Setting 114
 Switch-off delay time 115
- Interior lighting**
 see Interior lighting

- Interior lighting switch-off delay time** 115
- Internet connection**
- Automatic disconnection 235
 - Canceling permission 235
 - Connection status 236
 - Disconnecting 236
 - Displaying the connection status 236
 - Editing the access data 235
 - Establishing 235
 - Mobile phone details 235
 - Restrictions 233
 - Setting access data 234
 - Setting up 234
 - Setting up permanently 235
 - Via a Wi-Fi hotspot 234
 - Via Bluetooth® 234
- Internet favorites**
- Deleting 238
 - Setting 238
- Internet history**
- Deleting 237
- Internet radio**
- Calling up 238
 - Deleting stations 239
- Overview 238
- Registering 239
- Saving stations 239
- Selecting stream 239
- Setting options 239
- Terms of use 239
- Ionization** 122
- J**
- Jack**
- Storage location 277
- K**
- Key** 55
- Battery 57
 - Energy consumption 56
 - Overview 55
- KEYLESS-GO**
- Locking the vehicle 60
 - Problem 61
 - Unlocking setting 56
 - Unlocking the vehicle 60
- Kickdown** 138
- Using 138
- Knee airbag** 37
- L**
- Labeling (tires)**
- see Tire labeling
- Laden**
- Definitions 313
- Lamp (instrument display)**
- see Warning and indicator lamps
- Language**
- Notes 214
 - Setting 214
- LATCH-type (ISOFIX) child seat attachment**
- Installing 49
 - Notes 48
- Lighting**
- Instrument display 193
- Lighting**
- see Lights
- Lights** 110
- Adaptive Highbeam Assist 112
 - Automatic driving lights 111

- | | | | | | |
|---|-----|--|-----|-------------------------------------|-----|
| Combination switch | 111 | Low beam | | Maximum load rating | 310 |
| Cornering light function | 112 | Switching on/off | 110 | Maximum permissible load | |
| Hazard warning lights | 112 | Lubricant additives | | Calculation example | 305 |
| Headlamp flashing | 111 | see Additives | | Determining | 304 |
| High beam | 111 | Luggage | | Maximum tire pressures | 310 |
| Light switch | 110 | Securing | 94 | MB Info call | |
| Low beam | 110 | Lumbar support | | see Service call | |
| Parking lights | 110 | see Lumbar support (4-way) | | Media | |
| Rear fog light | 111 | Lumbar support (4-way) | 85 | Menu (on-board computer) | 197 |
| Responsibility for lighting systems | 110 | | | Searching | 246 |
| Standing lights | 110 | M | | Media display | |
| Turn signal light | 111 | | | Notes | 202 |
| Lights | | Main function | | Media Interface | |
| see Interior lighting | | Calling up | 205 | Activating | 247 |
| Limited Warranty | | Maintenance | | Information | 246 |
| Vehicle | 26 | Vehicle | 21 | Overview | 248 |
| Load index (tires) | 311 | Malfunction | | Media mode | |
| Load rating (tires) | 311 | Restraint system | 31 | Activating | 241 |
| Loading guidelines | 94 | Map functions | | Media playback | |
| Loading information table | 303 | Navigation | 218 | Operating (on-board computer) | 197 |
| Loads | | Massage programs | | Media search | |
| Securing | 94 | Overview | 88 | Starting | 246 |
| | | Matt finish (cleaning instructions) | 270 | | |

- Media source**
 Dial (on-board computer) 197
- Memory function**
 Head-up Display – Calling up saved settings 93
 Head-up Display – Saving settings 93
 Operating 93
 Outside mirror – Calling up saved settings 93
 Outside mirror – Saving settings 93
 Seat – Calling up saved settings 93
 Seat – Saving settings 93
 Steering wheel – Calling up saved settings 93
 Steering wheel – Saving settings 93
- Menu (on-board computer)**
 Assistance graphic 194
 Content 199
 Head-up Display 199
 Media 197
 Navigation 196
 Overview 191
 Radio 197
 Service 194
 Telephone 198
- Trip 195
- Mercedes-Benz Apps**
 Calling up 236
 Using voice control 236
- Mercedes-Benz mbrace®**
 Emergency call system 231
 Making a call via the overhead control panel 230
 MB Info call 232
 Roadside Assistance call 232
 Transmitted data 232
- Message (multifunction display)**
 see Display message
- Message memory** 336
- Messages**
 see Text messages
- Mirrors**
 see Outside mirror
 see Outside mirrors
- Mobile phone**
 Locking the vehicle 60
 Starting vehicle 128
 Unlocking the vehicle 60
- Wireless charging 107
- Mobile phone**
 see Telephone
- MOExtended tires** 278
- Motorway Pilot**
 Function/notes 163
- Multifunction display (on-board computer)** 193
- Multifunction steering wheel** 191
 Buttons 191
- Multimedia system**
 Adjusting the volume 208
 Calling up lists and menus 205
 Overview 202
 Restoring the factory settings 217
 Switching the sound on/off 207
 Using the character input function 208

N

Navigation

- Calculating a route 218
 Entering a destination 218
 Map functions 218

- | | | | | | |
|---|-----|--|-----|---|-----|
| Menu (on-board computer) | 196 | Children in the vehicle | 45 | Radio menu | 197 |
| Operating | 218 | Front passenger airbag shutoff | 39 | Service menu | 194 |
| Route guidance | 218 | PASSENGER AIR BAG indicator lamp | 41 | Telephone menu | 198 |
| Route guidance with traffic reports | 218 | Pets in the vehicle | 54 | Trip menu | 195 |
| Selecting route settings | 218 | PRE-SAFE® (anticipatory occupant protection) | 44 | On-board electronics | |
| Navigation messages | | PRE-SAFE® Impulse Side | 45 | Notes | 324 |
| On-board computer | 196 | PRE-SAFE® PLUS (anticipatory occupant protection plus) | 44 | Two-way radios | 324 |
| Near Field Communication | 214 | Seat belts | 33 | Operating fluids | |
| Starting the vehicle (mobile phone) | 128 | Odometer | | Additive (fuel) | 330 |
| Using | 214 | see Total distance | | Brake fluid | 331 |
| Neutral | | Oil | | Coolant (engine) | 331 |
| Selecting | 136 | see Engine oil | | Engine oil | 330 |
| NFC | | On-board computer | | Fuel (gasoline) | 329 |
| see Near Field Communication | | Assistance graphic menu | 194 | Notes | 328 |
| Noise | | Displaying the service due date | 261 | Refrigerant (air conditioning system) | 333 |
| Wheels and tires | 295 | Head-up Display menu | 199 | Windshield washer fluid | 332 |
| Notes | | Media menu | 197 | Operating safety | |
| Language | 214 | Menu content | 199 | Declaration of conformity (wireless vehicle components) | 23 |
| Notes on breaking-in a new vehicle | 129 | Menus | 191 | Information | 22 |
| O | | Multifunction display | 193 | Operator's Manual | |
| Occupant safety | | Navigation system menu | 196 | Vehicle equipment | 20 |
| Airbags | 37 | Operating | 191 | Outside mirror | 119 |
| | | | | Parking position | 119 |

Outside mirrors	118, 119
Anti-glare mode (automatic)	119
Folding in/out	118
Setting	118
Using the memory function	93
Overhead control panel	12
Overview	
Audio mode	242
Bluetooth® Audio	251
Call list	226
Central controls	202
Connection status	236
Favorites	205
Internet radio	238
Media Interface	248
Multimedia system	202
Radio	253
Satellite radio	256
Telephone menu	220
Video mode	245
Web browser	237
Wi-Fi	211

P

Paint (cleaning instructions)	270
Panic alarm	56
Activating/deactivating	56
Panoramic sliding sunroof	
see Sliding sunroof	
Park position	
Selecting	136
Selecting automatically	136
Parking	145
Parking aid	
see Driving system	
Parking assistance systems	
see Driving system	
Parking brake	
see Electric parking brake	
Parking lights	110
Parking Pilot	
Adjusting warning tones	172
Cross Traffic Alert	182
Drive Away Assist	181
Exiting a parking space	180
Function/notes	178
Maneuvering assistance	182
Parking	179
System limitations	178
Parking position	
Outside mirror	119
Passenger outside mirror – storing using the memory button	120
PARKTRONIC	
Activating	171
Adjusting warning tones	172
Deactivating	171
Function/notes	170
System limitations	170
Payload	
Calculation example	305
Determining the maximum	304
Pedestrian protection	
see Active hood (pedestrian protection)	
Perfume	
see Fragrance system	
Perfume vial	
see Fragrance system	

- Permission**
 Canceling 235
- Pets in the vehicle** 54
- Phone book**
 see Contacts
- Picture formats**
 see Video mode
- Picture settings**
 see Video mode
- PIN protection for data export** 215
- Plastic trim (Care)** 273
- Playback options**
 Selecting 243
- Power supply**
 Switching on (start/stop button) 126
- PRE-SAFE® (anticipatory occupant protection)**
 Function 44
 PRE-SAFE® Sound 44
 Reversing measures 44
- PRE-SAFE® Impulse Side**
 Activation 31
- Function 45
- PRE-SAFE® PLUS (anticipatory occupant protection plus)**
 Function 44
 Reversing measures 44
- Protection of the environment**
 Notes 19
- Q**
- QR code**
 Rescue card 26
- Qualified specialist workshop** 25
- R**
- Radar sensors** 146
- Radiator shutters**
 see AIRPANEL (Care)
- Radio**
 Activating 252
 Calling up the station list 254
 Delete station 254
 Direct frequency entry 254
 Displaying information 255
- Editing station presets 254
 Menu (on-board computer) 197
 Moving stations 254
 Overview 253
 Searching for stations 254
 Setting a station 254
 Setting the frequency band 254
 Storing stations 254
 Switching HD radio on/off 254
 Tagging music tracks 255
 To display radio text 255
- Radio station list**
 Calling up 254
- Radio stations**
 Dial (on-board computer) 197
- Rain closing function**
 Sliding sunroof 76
- Range** 195
- Reading lamp**
 see Interior lighting
- Rear door (child safety lock)** 52
- Rear fog light** 111

- Rear seat**
see Seat
- Rear view camera**
Function/notes 172
- Rear window**
Roller sun blind 69
- Rear window heater** 121
- Rear-view mirror**
see Outside mirrors
- Refrigerant (air conditioning system)**
Notes 333
- Refueling** 138
- Refueling process** 138
- Reporting malfunctions relevant to safety** 25
- Rescue card** 26
- Reset function (multimedia system)** 217
- Restoring (factory settings)**
see Reset function (multimedia system)
- Restraint system**
Children 45
Function in an accident 31
- Functionality 31
Malfunction 31
Protection 30
Reduced protection 30
System self-test 31
Warning lamp 31
- Restrictions**
Internet connection 233
- Reverse gear**
Selecting 136
- Reversing camera**
Care 271
Opening the camera cover 177
Switching automatic mode on/off 177
- RF transmitters**
see Two-way radios
- Rims (Care)** 271
- Roadside Assistance** 21
- Roadside Assistance**
see Service call
- Roadside Assistance call**
see Service call
- Roller sun blind**
Rear window 69
Side windows 69
- Roof lining (Care)** 273
- Roof load** 335
- Roof rack** 102
- Route guidance**
Navigation 218
- Route guidance with traffic reports**
Navigation 218
- Run-flat characteristics**
MOExtended tires 278
- S**
- Safety**
Children in the vehicle 45
- Safety vest** 276
- Satellite radio**
Activating 256
Deleting a channel 257
Displaying channel information 258
Displaying EPG information 257
Displaying service information 258

- Information 255
- Moving a channel 257
- Music and sport alerts function 257
- Overview 256
- Registering 255
- Restrictions 255
- Saving a channel 257
- Selecting a category 257
- Selecting a channel 257
- Setting the music and sport alerts 258
- Setting the parental control 257
- SD memory card**
- Inserting/removing 241
- Seat** 82, 97
- 4-way lumbar support 85
- Adjusting (electrically) 84
- Adjusting (manually and electrically) 82
- Adjusting (Seat Comfort) 84
- Backrest (rear passenger compartment) folding forwards 97
- Correct driver's seat position 81
- Folding back the backrest (rear passenger compartment) 98
- Locking the backrest (rear passenger compartment) 98
- Setting options 14
- Using the memory function 93
- Seat adjustment**
- Configuring 87
- Seat and massage settings**
- Resetting 89
- Seat belt adjustment**
- Activating/deactivating 36
- Function 35
- Seat belt warning**
- see Seat belts
- Seat belts** 35, 36
- Adjusting the height 35
- Belt airbag 35
- Care 273
- Fastening 35
- Protection 33
- Reduced protection 33
- Releasing 36
- Seat belt adjustment 35
- Warning lamp 36
- Seat cover (Care)** 273
- Seat heater**
- Switching on/off 89
- Seat ventilation**
- Switching on/off 90
- Selecting a gear**
- see Shifting gears
- Selector lever**
- see DIRECT SELECT selector lever
- Sensors (Care)** 271
- Service**
- Menu (on-board computer) 194
- Service call** 232
- MB Info call 232
- Roadside Assistance call 232
- Setting Daylight Saving Time (Summer)** 211
- Setting the date format** 211
- Setting the distance unit** 215
- Setting the sound profile**
- Burmester® high-end 3D surround sound system 260
- Setting up a hotspot (Wi-Fi)** 213

-
- Settings**
 - Display (multimedia system) 210
 - Shifting gears** 137
 - Automatic 136
 - Gearshift recommendation 137
 - Manual 137
 - Short text messages**
 - see Text messages
 - Side airbag** 37
 - Side windows**
 - Child safety lock in the rear passenger compartment 53
 - Closing 70
 - Closing with the SmartKey 72
 - Opening 70
 - Opening with the SmartKey 71
 - Problem 72
 - Roller sun blind 69
 - Size designation (tires)** 311
 - Sliding sunroof** 74
 - Automatic functions 76
 - Closing 74
 - Closing with the SmartKey 72
 - Opening 74
 - Opening with the SmartKey 71
 - Problem 77
 - Rain closing function 76
 - SmartKey**
 - Emergency key 57
 - Key ring attachment 57
 - Panic alarm 56
 - Problem 58
 - Unlocking setting 56
 - Smartphone**
 - Starting vehicle 128
 - Smartphone**
 - see Telephone
 - Snow chains** 296
 - Socket (12 V)**
 - Front center console 105
 - Rear passenger compartment 106
 - Socket (115 V)**
 - Rear passenger compartment 106
 - Software update**
 - Information 217
 - Performing 217
 - Sound**
 - PRE-SAFE® Sound 44
 - Sound settings**
 - Information 258
 - Speed control**
 - see Driving system
 - Speed control system**
 - see Driving system
 - Speed limit for winter tires**
 - Setting 157
 - Speed Limit Pilot** 158
 - Speed rating (tires)** 311
 - Speedometer**
 - Digital 195
 - Standby mode**
 - Activating/deactivating 146
 - Function 145
 - Standing lights** 110
 - Start/Stop button**
 - Starting vehicle 127
 - Switching off the vehicle 139

















- Switching on the power supply or ignition 126
- Start/stop function**
see ECO start/stop function
- Starting assistance** 285
- Starting the engine**
see Vehicle
- Starting-off aid**
see Hill start assist
- Station**
Deleting 254
Direct frequency entry 254
Moving 254
Searching 254
Setting 254
Storing 254
- Station presets**
Editing 254
- Steering Pilot**
Activating/deactivating 165
Function/notes 163
Information on 164
System limitations 163
- Steering wheel**
Adjusting (electrically) 91
Adjusting (manually) 90
Steering wheel heater 92
Using the memory function 93
- Steering wheel**
see Multifunction steering wheel
- Steering wheel heater**
Activating/deactivating 92
- Stowage compartment**
Armrest 95
Center console 95
Door 95
Eyeglasses box 96
Glove compartment 95
Rear armrest 96
- Stowage space under the trunk floor** 102
- Sun visor**
Operating 120
- Surround lighting**
Setting 114
- Surround View**
see 360° camera
- Suspension**
Adaptive Damping System 167
AIR BODY CONTROL 167
Setting the suspension level 169
- Suspension level**
Setting 169
- Switching the surround sound on/off**
Burmester® surround sound system 259
- Synchronization function**
Activating/deactivating (control panel) 122
- System settings**
Activating/deactivating Bluetooth® 211
Bluetooth® settings 211
Creating a user profile 216
Data import/export function 215
Importing/exporting data 215
Importing/exporting user profiles 216
Information on software updates 217
Language 214
Near Field Communication 214
Notes on language selection 214
PIN protection for data export 215
Reset function 217

- Selecting a user profile 216
 Setting the distance unit 215
 Software update 217
 User profile options 217
- T**
- Tailgate**
 see Trunk lid
- Tailpipes (Care)** 271
- Tank capacity (fuel)** 330
- Technical data**
 Information 324
 Tire pressure monitoring system 303
- TELEAID**
 Emergency call system 231
 Making a call via the overhead control panel 230
 MB Info call 232
 Roadside Assistance call 232
 Transmitted data 232
- Telephone** 220
 Activating functions during a call 223
 Call and ringtone volume 223
 Connecting a mobile phone (Pass-key) 222
 Connecting a mobile phone (Secure Simple Pairing) 222
 Disconnecting the mobile phone 222
 Menu (on-board computer) 198
 Notes 221
 Reception and transmission volume 223
 Switching mobile phones 223
 Telephone menu overview 220
 Telephone operation 223
- Telephone number**
 Dialing (on-board computer) 198
- Temperature** 121
- Temperature grade** 308
- Text messages** 227
 Calling a sender 228
 Composing 228
 Configuring the text messages displayed 227
 Deleting 228
 Notes 227
 Read-aloud function 227
 Reading 227
 Replying 228
- Tie-down eyes** 99
- Time**
 Manual time setting 211
 Setting Daylight Saving Time (Summer) 211
 Setting the time and date automatically 210
 Setting the time zone 210
 Setting the time/date format 211
- TIN (Tire Identification Number)** 309
- Tire and Loading Information placard** 303
- Tire characteristics** 311
- Tire inflation compressor**
 see TIREFIT kit
- Tire information table** 303
- Tire labeling** 308
 Characteristics 311
 DOT, Tire Identification Number (TIN) ... 309
 Load index 311
 Load rating 311
 Maximum tire load 310
 Maximum tire pressure 310

- Overview 308
- Speed rating 311
- Temperature grade 308
- Tire Quality Grading 308
- Tire size designation 311
- Traction grade 308
- Tread wear grade 308
- Tire load (maximum)** 310
- Tire pressure**
 - Checking (manually) 300
 - Checking (tire pressure monitoring system) 301
 - Maximum 310
 - Notes 297
 - Restarting the tire pressure monitoring system 302
 - Tire pressure monitoring system (function) 300
 - Tire pressure table 298
- Tire pressure monitoring system**
 - Checking the tire pressure 301
 - Function 300
 - Restarting 302
 - Technical data 303
- Tire pressure table** 298
- Tire Quality Grading** 308
- Tire tread** 295
- Tire-change tool kit**
 - Overview 277
- TIREFIT kit** 278
 - Storage location 278
 - Using 279
- Tires**
 - Changing 319
 - Characteristics 311
 - Checking 295
 - Checking the tire pressure (manually) 300
 - Checking the tire pressure (tire pressure monitoring system) 301
 - Definitions 313
 - DOT, Tire Identification Number (TIN) ... 309
 - Flat tire 278
 - Load index 311
 - Load rating 311
 - Maximum tire load 310
 - Maximum tire pressure 310
 - MOExtended tires 278
- Noise 295
- Notes on Installing 316
- Overview of tire labeling 308
- Replacing 316
- Restarting the tire pressure monitoring system 302
- Selection 316
- Snow chains 296
- Speed rating 311
- Storing 319
- Temperature grade 308
- Tire and Loading Information placard ... 303
- Tire pressure (Notes) 297
- Tire pressure monitoring system (function) 300
- Tire pressure table 298
- Tire Quality Grading 308
- Tire size designation 311
- TIREFIT kit 279
- Traction grade 308
- Tread wear grade 308
- Unusual handling characteristics 295
- Tone settings**
 - Adjusting the balance/fader 259
 - Calling up the sound menu 258

- Setting the treble, mid range and bass 258
- Top Tether** 50
- Total distance** 195
- Touch Control**
- On-board computer 191
 - Operating 203
 - Setting the sensitivity 203
- Touchpad**
- Operating 204
 - Reading the handwriting recognition aloud 205
 - Setting the sensitivity 204
- Tow starting** 291
- Towing away** 288
- Towing eye**
- Installing 291
 - Storage location 277
- Track**
- Selecting 243
- Traction grade** 308
- Trailer hitch**
- Care 271
- Transmission position display** 134
- Transporting**
- Pets 54
 - Vehicle 290
- Tread wear grade** 308
- Trim (Care)** 273
- Trip**
- Menu (on-board computer) 195
- Trip computer**
- Displaying 195
 - Resetting 196
- Trip distance**
- Displaying 195
 - Resetting 196
- Trunk box**
- see EASY-PACK trunk box
- Trunk lid** 63
- Closing 64
 - Emergency release (from inside) 68
 - HANDS-FREE ACCESS 66
 - Locked separately 68
 - Opening 63
 - Opening dimensions 334
- Trunk lid**
- see Trunk lid
- Trunk lid opening height restriction**
- Activating/deactivating 69
- Trunk load** 335
- Turn signal indicator**
- see Turn signal light
- Turn signal light** 111
- Activating/deactivating 111
- Two-way radios** 324
- Frequencies 324
 - Notes on installation 324
 - Transmission output (maximum) 324
- U**
- Unlocking setting** 56
- USB devices**
- Connecting 243
- User profile**
- Creating 216
 - Importing/exporting 216

- Options 217
 - Selecting 216
 - Using the telephone**
 - see Calls
- V**
- Vehicle** 127, 128, 129
 - Correct use 25
 - Data acquisition 26
 - Electronics 324
 - Equipment 20
 - Limited Warranty 26
 - Locking (automatically) 62
 - Locking (from inside) 59
 - Locking (KEYLESS-GO) 60
 - Locking (mobile phone) 60
 - Maintenance 21
 - Parking 145
 - Problem notification 25
 - Starting (emergency operation mode) .. 129
 - Starting (mobile phone) 128
 - Starting (smartphone) 128
 - Starting (start/stop button) 127
 - Switching off (start/stop button) 139
 - Unlocking (from inside) 59
 - Unlocking (KEYLESS-GO) 60
 - Unlocking (mobile phone) 60
 - Vehicle data 334
 - Ventilating (convenience opening) 71
 - Vehicle data**
 - Displaying 134
 - Roof load 335
 - Trunk load 335
 - Turning radius 334
 - Vehicle height 334
 - Vehicle length 334
 - Vehicle width 334
 - Wheelbase 334
 - Vehicle dimensions** 334
 - Vehicle identification number**
 - see VIN
 - Vehicle identification plate** 326
 - Paint code 326
 - VIN 326
 - Vehicle interior**
 - Cooling or heating (smartphone) 127
 - Vehicle operation**
 - Outside the USA or Canada 21
 - Vehicle tool kit**
 - Tire-change tool kit 277
 - TIREFIT kit 278
 - Towing eye 277
 - Ventilating**
 - Convenience opening 71
 - Ventilation**
 - see Climate control
 - Vents**
 - see Air vents
 - Video mode** 246
 - Activating 244
 - Activating/deactivating full-screen mode 246
 - Overview 245
 - Settings 246
 - VIN** 326
 - Identification plate 326
 - Seat 326
 - Visibility**
 - Defrosting the windows 122
 - Windshield heater 124

- W**
- Warning and indicator lamps** 379
 Instrument display (overview) 8
 Overview 379
 PASSENGER AIR BAG 41
- Warning lamp**
 see Warning and indicator lamps
- Warning system**
 see Anti-theft protection
- Warning/indicator lamp**
-  ABS warning lamp 385
 -  Brake warning lamp (USA) 381
 -  Brakes warning lamp (Canada) 381
 -  Coolant warning lamp 390
 -  Distance warning lamp 388
 -  Engine diagnosis warning lamp 389
 -  ESP® OFF warning lamp 386
 -  ESP® warning lamp 382, 385
 -  Fuel reserve warning lamp 391
 -  Power steering system warning lamp 388
-  Red electric parking brake indicator lamp (USA only) 383
 -  Red indicator lamp electric parking brake (Canada only) 383
 -  Restraint system warning lamp 384
 -  Seat belt warning lamp 387
 -  Tire pressure monitoring system warning lamp 392, 393
 -  Yellow electric parking brake indicator lamp is malfunctioning 383
- Warranty** 26
- Washer fluid**
 see Windshield washer fluid
- Washing by hand (care)** 269
- Web browser**
- Calling up a website 237
 - Calling up options 237
 - Calling up settings 237
 - Closing 238
 - Deleting Internet favorites 238
 - Deleting the Internet history 237
 - Overview 237
 - Setting Internet favorites 238
- Website**
 Calling up 237
- Wheel check**
 Storage location 277
- Wheel rotation** 318
- Wheels**
- Care 271
 - Changing 319
 - Checking 295
 - Checking the tire pressure (manually) 300
 - Checking the tire pressure (tire pressure monitoring system) 301
 - Definitions 313
 - DOT, Tire Identification Number (TIN) ... 309
 - Flat tire 278
 - Load index 311
 - Load rating 311
 - Maximum tire load 310
 - Maximum tire pressure 310
 - MOExtended tires 278
 - Noise 295
 - Notes on installing 316

- Overview of tire labeling 308
- Replacing 316
- Restarting the tire pressure monitoring system 302
- Rotating 318
- Selection 316
- Snow chains 296
- Speed rating 311
- Storing 319
- Temperature grade 308
- Tire and Loading Information placard ... 303
- Tire characteristics 311
- Tire pressure (Notes) 297
- Tire pressure monitoring system (function) 300
- Tire pressure table 298
- Tire Quality Grading 308
- Tire size designation 311
- TIREFIT kit 279
- Traction grade 308
- Tread wear grade 308
- Unusual handling characteristics 295
- Wi-Fi**
 - Overview 211
 - Setting 212
- Setting up a hotspot 213
- Window airbag** 37
- Windows**
 - Closing 70
 - Opening 70
- Windows (Care)** 271
- Windshield** 116, 121
 - Defrosting 121
 - Replacing the wiper blades 116
- Windshield**
 - see Windshield
- Windshield heater** 124
- Windshield heating**
 - see Windshield heater
- Windshield washer fluid** 332
 - Notes 332
- Windshield washer system**
 - Refilling 267
- Windshield wipers**
 - Activating/deactivating 115
 - Replacing the wiper blades 116
- Winter**
 - Snow chains 296
- Winter operation**
 - Snow chains 296
- Wiper blades**
 - Care 271
 - Changing 116
- Wireless vehicle components**
 - Declaration of Conformity 23

