



# G-Class

Operator's Manual



4635842905

Order no. P463 0165 13 Part no. 463 584 29 05 Edition A 2018

G-Class Operator's Manual

Mercedes-Benz



## Symbols

Registered trademarks:

- Bluetooth® is a registered trademark of Bluetooth SIG Inc.
- DTS™ is a registered trademark of DTS, Inc.
- Dolby® and MLP™ are registered trademarks of DOLBY Laboratories.
- BabySmart™, ESP® and PRE-SAFE® are registered trademarks of Daimler AG.
- HomeLink® is a registered trademark of Johnson Controls.
- iPod® and iTunes® are registered trademarks of Apple Inc.
- Logic 7® is a registered trademark of Harman International Industries.
- Microsoft® and Windows media® are registered trademarks of Microsoft Corporation.
- SIRIUS® is a registered trademark of Sirius XM Radio Inc.
- HD Radio™ is a registered trademark of iBiquity Digital Corporation.
- Gracenote® is a registered trademark of Gracenote, Inc.
- ZAGAT Survey® and related brands are registered trademarks of Zagat Survey, LLC.

In this Operator's Manual you will find the following symbols:

### **WARNING**

Warning notes make you aware of dangers which could pose a threat to your health or life, or to the health and life of others.

### **Environmental note**

Environmental notes provide you with information on environmentally aware actions or disposal.

 Notes on material damage alert you to dangers that could lead to damage to your vehicle.

 Practical tips or further information that could be helpful to you.

- ▶ This symbol indicates an instruction that must be followed.
- ▶ Several of these symbols in succession indicate an

instruction with several steps.

(▷ This symbol tells you where you can find more information about a topic.

▷▷ This symbol indicates a warning or an instruction that is continued on the next page.

**Display** This text indicates a message on the multifunction display/multimedia display.

## Publication details

### Internet

Further information about Mercedes-Benz vehicles and about Daimler AG can be found on the following websites:

<http://www.mbusa.com> (USA only)

<http://www.mercedes-benz.ca> (Canada only)

### Editorial office

©Daimler AG: not to be reprinted, translated or otherwise reproduced, in whole or in part, without written permission from Daimler AG.

### Vehicle manufacturer

Daimler AG  
Mercedesstraße 137  
70327 Stuttgart  
Germany

## Welcome to the world of Mercedes-Benz

We urge you to read this Operator's Manual carefully and familiarize yourself with the vehicle before driving. For your own safety and a longer vehicle life, follow the instructions and warning notices in this Operator's Manual. Ignoring them could result in damage to the vehicle or personal injury to you or others.

Vehicle damage caused by failure to follow instructions is not covered by the Mercedes-Benz Limited Warranty.

The equipment or product designation of your vehicle may vary depending on:

- Model
- Order
- Country specification
- Availability

Mercedes-Benz therefore reserves the right to introduce changes in the following areas:

- Design
- Equipment
- Technical features

The equipment in your vehicle may therefore differ from that shown in the descriptions and illustrations.

The following are integral components of the vehicle:

- Digital Operator's Manual
- Printed Operator's Manual
- Maintenance Booklet
- Equipment-dependent supplements

Keep these documents in the vehicle at all times. If you sell the vehicle, always pass all documents on to the new owner.

### Your Operator's Manual:

#### Digital form inside the vehicle

The Digital Operator's Manual provides comprehensive and specifically adapted information on your vehicle's equipment and multimedia system. It contains informative animations, individual language settings and an intuitive search function.

#### Booklet inside the vehicle

In addition to this manual and the aforementioned digital media, you also have the option to obtain a comprehensive printed version of the Supplement for your multimedia system from your authorized Mercedes-Benz Center.

#### Digital form via the Internet

The Operator's Manual on the Internet provides easy access to all information regarding your vehicle and multimedia system. It also provides helpful animations, interesting background information and a wide array of search options.

#### Digital form as an app

Using the Mercedes-Benz Guides app, you can view all the information on your vehicle and multimedia system via mobile Internet or download it independently of network access. Available for smartphones or tablets.



Apple® iOS



Android™

Please note that the Mercedes-Benz Guides app may not yet be available in your country.

Mercedes-Benz USA, LLC  
Mercedes-Benz Canada, Inc.  
A Daimler Company

<b>Index</b> .....	<b>4</b>	Memory functions .....	84
<b>Digital Operator's Manual</b> .....	<b>22</b>	<b>Lights and windshield wipers</b> .....	<b>86</b>
Introduction .....	22	Exterior lighting .....	86
Operation .....	22	Interior lighting .....	89
<b>Introduction</b> .....	<b>23</b>	Replacing bulbs .....	89
Protecting the environment .....	23	Windshield wipers .....	93
Genuine Mercedes-Benz parts .....	23	<b>Climate control</b> .....	<b>96</b>
Operator's Manual .....	24	Overview of the climate control sys- tem .....	96
Service and vehicle operation .....	24	Operating the climate control system ....	98
Operating safety .....	26	Air vents .....	102
QR codes for rescue cards .....	28	<b>Driving and parking</b> .....	<b>104</b>
Data stored in the vehicle .....	28	Notes on breaking-in a new vehicle ....	104
Information on copyright .....	29	Driving .....	104
<b>At a glance</b> .....	<b>31</b>	Adjustable damping .....	111
Cockpit .....	31	Automatic transmission .....	111
Instrument cluster .....	32	Refueling .....	120
Multifunction steering wheel .....	33	Parking .....	122
Center console .....	34	Driving tips .....	124
Overhead control panel .....	36	Driving systems .....	133
Door control panel .....	37	Off-road driving systems .....	149
<b>Safety</b> .....	<b>38</b>	Towing a trailer .....	153
Panic alarm .....	38	<b>On-board computer and displays</b> ....	<b>160</b>
Occupant safety .....	38	Important safety notes .....	160
Children in the vehicle .....	50	Displays and operation .....	160
Pets in the vehicle .....	57	Menus and submenus .....	162
Driving safety systems .....	58	Display messages .....	173
Protection against theft .....	62	Warning and indicator lamps in the instrument cluster .....	191
<b>Opening and closing</b> .....	<b>63</b>	<b>Multimedia system</b> .....	<b>203</b>
SmartKey .....	63	General notes .....	203
Doors .....	66	Important safety notes .....	203
Rear door .....	68	Function restrictions .....	203
Side windows .....	69	Operating system .....	204
Sliding sunroof .....	71	<b>Stowage and features</b> .....	<b>209</b>
<b>Seats, steering wheel and mirrors</b> ....	<b>74</b>	Loading guidelines .....	209
Correct driver's seat position .....	74	Stowage areas .....	210
Seats .....	74	Features .....	215
Steering wheel .....	79		
Mirrors .....	81		

---

<b>Maintenance and care</b> .....	<b>230</b>
Engine compartment .....	230
Maintenance .....	235
Care .....	236

---

<b>Breakdown assistance</b> .....	<b>243</b>
Where will I find...? .....	243
Flat tire .....	246
Battery (vehicle) .....	246
Jump starting .....	249
Towing and tow-starting .....	251
Fuses .....	254

---

<b>Wheels and tires</b> .....	<b>257</b>
Important safety notes .....	257
Operation .....	257
Winter operation .....	258
Tire pressure .....	260
Loading the vehicle .....	266
All about wheels and tires .....	269
Changing a wheel .....	275
Wheel and tire combinations .....	279
Spare wheel .....	279

---

<b>Technical data</b> .....	<b>281</b>
Information regarding technical data ...	281
Vehicle electronics .....	281
Identification plates .....	282
Service products and filling capacities .....	283
Vehicle data .....	288
Vehicle data for off-road driving .....	290
Trailer tow hitch .....	291

## 1, 2, 3 ...

**4ETS (Electronic Traction System)** .... 59

**12 V socket**

see Socket (12 V)

**115 V socket** ..... 218

**A****ABS (Anti-lock Braking System)**

Display message ..... 175

Function/notes ..... 58

Warning lamp ..... 194

**Accident**

Automatic measures after an accident ..... 50

**Activating media mode**

General notes ..... 208

**ADAPTIVE BRAKE** ..... 61

**Additives (engine oil)** ..... 286

**Address book**

see also Digital Operator's Manual ..... 203

**Adjustable damping** ..... 111

**Adjusting the volume**

Multimedia system ..... 204

**Air bags**

Deployment ..... 47

Display message ..... 179

Front air bag (driver, front passenger) ..... 45

Important safety notes ..... 44

Introduction ..... 44

PASSENGER AIR BAG OFF indicator lamp ..... 39

Pelvis air bag ..... 46

Side impact air bag ..... 45

Window curtain air bag ..... 46

**Air vents**

Important safety notes ..... 102

Rear ..... 103

Setting ..... 102

Setting the center air vents ..... 103

Setting the side air vents ..... 103

**Air-conditioning system**

see Climate control

**Alarm**

ATA (Anti-Theft Alarm system) ..... 62

Switching off (ATA) ..... 62

Switching the function on/off (ATA) ..... 62

**Alarm system**

see ATA (Anti-Theft Alarm system)

**All-wheel drive**

Transfer case ..... 149

**AMG menu (on-board computer)** ..... 171

**Anti-theft alarm system**

see ATA (Anti-Theft Alarm system)

**Approach/departure angle** ..... 132

**Ashtray** ..... 216

**Assistance display (on-board computer)** ..... 167

**Assistance menu (on-board computer)** ..... 167

**ASSYST service interval display**

Service messages ..... 235

**ATA (Anti-Theft Alarm system)**

Activating/deactivating ..... 62

Function ..... 62

Switching off the alarm ..... 62

**Authorized Mercedes-Benz Center**

see Qualified specialist workshop

**AUTO lights**

Display message ..... 180

see Lights

**Automatic car wash (care)** ..... 236

**Automatic engine start (ECO start/stop function)** ..... 109

**Automatic engine switch-off (ECO start/stop function)** ..... 108

**Automatic headlamp mode** ..... 87

**Automatic transmission**

Display message ..... 190

Drive position (ECO start/stop function) ..... 113

Drive program ..... 116

Driving tips ..... 114

Emergency running mode ..... 119

Engaging drive position ..... 113

Engaging neutral ..... 113

Engaging reverse gear ..... 112

Engaging the park position ..... 112

Important safety notes ..... 111

Kickdown ..... 114

Manual shifting ..... 117

- Neutral (ECO start/stop function) ..... 113
  - Overview ..... 111
  - Problem (malfunction) ..... 119
  - Program selector button ..... 115
  - Pulling away ..... 106
  - Selector lever ..... 112
  - Shift ranges ..... 116
  - Steering wheel paddle shifters ..... 116
  - Trailer towing ..... 115
  - Transmission position display ..... 112
  - Automatic transmission emergency mode** ..... 119
  - Axle load, permissible (trailer towing)** ..... 291
- B**
- BabySmart™**
    - Air bag deactivation system ..... 53
  - Back button** ..... 204
  - Backup lamp**
    - Replacing bulbs ..... 92
  - Ball coupling**
    - Installing ..... 156
  - BAS (Brake Assist System)** ..... 59
  - Battery (SmartKey)**
    - Checking ..... 65
    - Important safety notes ..... 64
    - Replacing ..... 65
  - Battery (vehicle)**
    - Charging ..... 248
    - Display message ..... 182
    - Important safety notes ..... 246
    - Jump starting ..... 249
    - Overview ..... 246
  - Belt warning** ..... 43
  - Blind Spot Assist**
    - Activating/deactivating ..... 167
    - Activating/deactivating (on-board computer) ..... 167
    - Display message ..... 185
    - Notes/function ..... 140
  - Bluetooth®**
    - Searching for a mobile phone ..... 207
    - see also Digital Operator's Manual ..... 203
    - Telephony ..... 206
  - Brake fluid**
    - Display message ..... 177
    - Notes ..... 286
  - Brake fluid level** ..... 235
  - Brake force distribution**
    - see EBD (electronic brake force distribution)
  - Brake lamp**
    - Replacing bulbs ..... 92
  - Brake lamps**
    - Display message ..... 180
  - Brakes**
    - ABS ..... 58
    - BAS ..... 59
    - Brake fluid (notes) ..... 286
    - Display message ..... 175
    - EBD ..... 61
    - High-performance brake system .... 127
    - Hill start assist ..... 107
    - HOLD function ..... 142
    - Important safety notes ..... 125
    - Maintenance ..... 126
    - Parking brake ..... 123
    - Riding tips ..... 125
    - Warning lamp ..... 193
  - Breakdown**
    - see Flat tire
    - see Towing away
  - Brightness control (instrument cluster lighting)** ..... 32
  - Brush guard** ..... 226
  - Bulbs**
    - Backup lamp ..... 90
    - Brake lamp ..... 90
    - Rear fog lamp ..... 90
    - Standing lamps (rear) ..... 90
    - Tail lamp ..... 90
    - Turn signal lamp (front) ..... 90
    - Turn signal lamp (rear) ..... 90
    - see Replacing bulbs
- C**
- California**
    - Important notice for retail customers and lessees ..... 24
  - Calling up a malfunction**
    - see Display messages

- Camera**
  - see Rear view camera
- Care**
  - Car wash ..... 236
  - Carpets ..... 242
  - Chrome parts ..... 240
  - Display ..... 241
  - Exhaust pipe ..... 240
  - Exterior lights ..... 239
  - General notes ..... 236
  - Interior ..... 241
  - Matte finish ..... 238
  - Paint ..... 238
  - Plastic trim ..... 241
  - Power washer ..... 237
  - Rear view camera ..... 240
  - Roof lining ..... 242
  - Seat belt ..... 242
  - Seat cover ..... 241
  - Selector lever ..... 241
  - Sensors ..... 239
  - Steering wheel ..... 241
  - Trim pieces ..... 241
  - Washing by hand ..... 237
  - Wheels ..... 238
  - Windows ..... 239
  - Wiper blades ..... 239
  - Wooden trim ..... 241
- Cargo compartment cover**
  - Important safety notes ..... 214
  - Installing/removing ..... 214
  - Notes/how to use ..... 214
  - Opening and closing ..... 214
- Cargo compartment enlargement**
  - Important safety notes ..... 211
- Cargo tie down rings** ..... 214
- CD**
  - see also Digital Operator's Manual ..... 203
- CD player/CD changer (on-board computer)** ..... 165
- Center console**
  - Lower section ..... 35
  - Overview ..... 34
  - Upper section ..... 34
- Central locking**
  - Automatic locking (on-board computer) ..... 170
  - Locking/unlocking (SmartKey) ..... 63
- Change of address** ..... 25
- Change of ownership** ..... 25
- Changing bulbs**
  - Standing lamp (rear) ..... 92
- Changing gears** ..... 114
- Child**
  - Restraint system ..... 51
- Child seat**
  - BabySmart™ air bag deactivation system ..... 53
  - Forward-facing restraint system ..... 55
  - LATCH-type (ISOFIX) child seat anchors ..... 52
  - On the front-passenger seat ..... 55
  - Problem (malfunction) ..... 56
  - Rearward-facing restraint system .... 55
  - Top Tether ..... 52
- Child-proof locks**
  - Important safety notes ..... 56
  - Rear door ..... 57
  - Rear doors ..... 57
- Children**
  - Special seat belt retractor ..... 50
- Children in the vehicle**
  - Important safety notes ..... 50
- Chrome parts (cleaning instructions)** ..... 240
- Cigarette lighter** ..... 217
- Cleaning**
  - Mirror turn signal ..... 239
  - Trailer tow hitch ..... 240
- Climate control**
  - Controlling automatically ..... 99
  - Cooling with air dehumidification .... 98
  - Defrosting the windows ..... 100
  - Defrosting the windshield ..... 100
  - Dual-zone automatic climate control ..... 96
  - ECO start/stop function ..... 98
  - Important safety notes ..... 96
  - Indicator lamp ..... 98
  - Maximum cooling ..... 100
  - Notes on using dual-zone automatic climate control ..... 97
  - Overview of systems ..... 96



- Problem with the rear window defroster ..... 101
  - Problems with "cooling with air dehumidification" ..... 98
  - Refrigerant ..... 287
  - Refrigerant filling capacity ..... 288
  - Setting the air distribution ..... 99
  - Setting the air vents ..... 102
  - Setting the airflow ..... 99
  - Setting the temperature ..... 99
  - Switching air-recirculation mode on/off ..... 102
  - Switching on/off ..... 98
  - Switching residual heat on/off ..... 102
  - Switching the rear window defroster on/off ..... 101
  - Switching the ZONE function on/off ..... 100
  - Windshield defroster ..... 101
  - Clock (on-board computer)** ..... 169
  - Cockpit**
    - Overview ..... 31
  - COMAND**
    - see separate operating instructions
  - COMAND display**
    - Cleaning ..... 241
  - Combination switch** ..... 88
  - Connecting a USB device**
    - see also Digital Operator's Manual ..... 203
  - Consumption statistics (on-board computer)** ..... 163
  - Controller** ..... 204
  - Controlling speed**
    - see DISTRONIC PLUS
  - Convenience closing feature** ..... 70
  - Convenience opening feature** ..... 70
  - Coolant (engine)**
    - Checking the level ..... 234
    - Display message ..... 180
    - Filling capacity ..... 287
    - Notes ..... 286
    - Temperature (on-board computer) ..... 171
    - Temperature gauge ..... 161
    - Warning lamp ..... 199
  - Cooling**
    - see Climate control
  - Copyright** ..... 29
  - Cruise control**
    - Cruise control lever ..... 133
    - Deactivating ..... 134
    - Driving system ..... 133
    - Function/notes ..... 133
    - General notes ..... 133
    - Important safety notes ..... 133
    - Resuming the stored speed ..... 134
    - Setting a speed ..... 134
    - Storing and maintaining current speed ..... 133
  - Cup holder**
    - Center console ..... 215
    - Important safety notes ..... 215
    - Rear compartment ..... 215
- ## D
- Data**
    - see Technical data
  - Date (on-board computer)** ..... 168
  - Daytime running lamps**
    - Display message ..... 180
    - Switching on/off (on-board computer) ..... 169
    - Switching on/off (switch) ..... 86
  - Delayed switch-off**
    - Exterior lighting (on-board computer) ..... 169
    - Interior lighting ..... 169
  - Diagnostics connection** ..... 27
  - Differential locks**
    - Disengaging ..... 153
    - Engaging ..... 151
    - Front axle ..... 152
    - General notes ..... 151
    - Rear axle ..... 152
    - Terrain ..... 151
    - Transfer case ..... 152
  - Digital Operator's Manual**
    - Help ..... 22
    - Introduction ..... 22
  - Digital speedometer** ..... 163
  - Display messages**
    - Calling up (on-board computer) ..... 174

- Driving systems ..... 183
- Engine ..... 180
- General notes ..... 173
- Hiding (on-board computer) ..... 173
- Lights ..... 180
- Safety systems ..... 175
- Service interval display ..... 235
- SmartKey ..... 191
- Tires ..... 187
- Vehicle ..... 190
- Distance recorder**
  - see Odometer
  - see Trip odometer
- Distance warning (warning lamp) ....** 201
- DISTRONIC PLUS**
  - Activating ..... 136
  - Activation conditions ..... 136
  - Cruise control lever ..... 136
  - Deactivating ..... 139
  - Display message ..... 185
  - Displays in the instrument cluster .. 139
  - Displays in the multifunction display ..... 139
  - Driving tips ..... 140
  - Driving with DISTRONIC PLUS ..... 137
  - Function/notes ..... 134
  - Important safety notes ..... 135
  - Setting a speed ..... 138
  - Setting the specified minimum distance ..... 138
  - Stopping ..... 137
  - Warning lamp ..... 201
- Doors**
  - Automatic locking (on-board computer) ..... 170
  - Automatic locking (switch) ..... 67
  - Central locking/unlocking (SmartKey) ..... 63
  - Control panel ..... 37
  - Display message ..... 190
  - Emergency locking ..... 68
  - Emergency unlocking ..... 68
  - Important safety notes ..... 66
  - Opening (from inside) ..... 67
  - Overview ..... 66
- Drinking and driving** ..... 125
- Drive program**
  - Automatic transmission ..... 116
  - Display ..... 112
  - SETUP (on-board computer, Mercedes-AMG vehicles) ..... 171
- Driver's door**
  - see Doors
- Driving downhill** ..... 132
- Driving in mountainous terrain**
  - Approach/departure angle ..... 132
  - Driving downhill ..... 132
  - Gradient-climbing capability (maximum) ..... 132
- Driving lamps**
  - see Daytime running lamps
- Driving off-road**
  - Driving downhill ..... 132
  - see Off-road driving
- Driving on flooded roads** ..... 128
- Driving safety systems**
  - ABS (Anti-lock Braking System) ..... 58
  - ADAPTIVE BRAKE ..... 61
  - BAS (Brake Assist System) ..... 59
  - EBD (electronic brake force distribution) ..... 61
  - ESP® (Electronic Stability Program) ..... 59
  - Important safety information ..... 58
  - Overview ..... 58
- Driving systems**
  - Blind Spot Assist ..... 140
  - Cruise control ..... 133
  - Display message ..... 183
  - DISTRONIC PLUS ..... 134
  - HOLD function ..... 142
  - PARKTRONIC ..... 143
  - Rear view camera ..... 146
- Driving tips**
  - Automatic transmission ..... 114
  - Brakes ..... 125
  - Break-in period ..... 104
  - DISTRONIC PLUS ..... 140
  - Downhill gradient ..... 125
  - Drinking and driving ..... 125
  - Driving in winter ..... 128
  - Driving on flooded roads ..... 128
  - Driving on sand ..... 131
  - Driving on wet roads ..... 127
  - Driving over obstacles ..... 131
  - Exhaust check ..... 125

- Fuel ..... 124
  - General ..... 124
  - Gravel roads ..... 131
  - Hydroplaning ..... 127
  - Icy road surfaces ..... 128
  - Important safety notes ..... 104
  - Limited braking efficiency on salted roads ..... 126
  - Off-road driving ..... 129
  - Off-road fording ..... 128
  - Pulling away on slippery surfaces .. 127
  - Snow chains ..... 259
  - Subjecting brakes to a load ..... 126
  - The first 1500 km ..... 104
  - Tire ruts ..... 131
  - Towing a trailer ..... 154
  - Traveling uphill ..... 132
  - Wet road surface ..... 126
  - DVD audio**
    - Operating (on-board computer) .... 165
  - DVD video**
    - Operating (on-board computer) .... 166
    - see also Digital Operator's Manual ..... 203
- E**
- EASY-ENTRY feature**
    - Activating/deactivating ..... 170
    - Function/notes ..... 81
  - EASY-EXIT feature**
    - Function/notes ..... 81
    - Switching on/off ..... 170
  - EBD (electronic brake force distribution)**
    - Display message ..... 176
    - Function/notes ..... 61
  - ECO start/stop function**
    - Deactivating/activating ..... 108
    - General information ..... 107
  - Electronic Stability Program**
    - see ESP® (Electronic Stability Program)
  - Electronic Traction System**
    - see 4ETS (Electronic Traction System)
  - Emergency**
    - Automatic measures after an accident ..... 50
  - Emergency release**
    - Driver's door ..... 68
    - Vehicle ..... 68
  - Emergency Tensioning Devices**
    - Activation ..... 47
  - Emissions control**
    - Service and warranty information .... 24
  - Engine**
    - Check Engine warning lamp ..... 199
    - Display message ..... 180
    - ECO start/stop function ..... 107
    - Engine number ..... 283
    - Irregular running ..... 110
    - Jump-starting ..... 249
    - Starting problems ..... 110
    - Starting the engine with the SmartKey ..... 106
    - Switching off ..... 123
    - Tow-starting (vehicle) ..... 254
  - Engine electronics**
    - Problem (malfunction) ..... 110
  - Engine oil**
    - Adding ..... 233
    - Additives ..... 286
    - Checking the oil level ..... 232
    - Checking the oil level using the dipstick ..... 232
    - Checking the oil level using the on-board computer ..... 232
    - Display message ..... 182
    - Filling capacity ..... 286
    - General notes ..... 285
    - Notes about oil grades ..... 285
    - Notes on oil level/consumption .... 232
    - Temperature (on-board computer) ..... 171
  - Entering an address**
    - see also Digital Operator's Manual ..... 203
  - ESP® (Electronic Stability Program)**
    - 4ETS (Electronic Traction System) ..... 59
    - AMG menu (on-board computer) ... 171
    - Characteristics ..... 60
    - Deactivating/activating ..... 60
    - Display message ..... 175
    - Function/notes ..... 59

- General notes ..... 59
  - Important safety information ..... 59
  - Trailer stabilization ..... 61
  - Warning lamp ..... 196
  - Exhaust**
    - see Exhaust pipe
  - Exhaust check** ..... 125
  - Exhaust pipe**
    - Cleaning ..... 240
  - Exterior lighting**
    - Cleaning ..... 239
    - see Lights
  - Exterior mirrors**
    - Adjusting ..... 82
    - Dipping (automatic) ..... 83
    - Folding in when locking (on-board computer) ..... 170
    - Folding in/out (automatically) ..... 83
    - Folding in/out (electrically) ..... 82
    - Out of position (troubleshooting) ..... 83
    - Setting ..... 82
    - Storing settings (memory function) ..... 84
    - Storing the parking position ..... 83
- F**
- Favorites**
    - Overview ..... 205
  - Filler cap**
    - see Refueling
  - First-aid kit** ..... 244
  - Flat tire**
    - Changing a wheel/mounting the spare wheel ..... 275
    - Preparing the vehicle ..... 246
  - Folding the seat backrest (rear)**
  - forwards/back** ..... 212
  - Frequencies**
    - Mobile phone ..... 281
    - Two-way radio ..... 281
  - Fuel**
    - Additives ..... 285
    - Consumption statistics ..... 163
    - Displaying the range ..... 163
    - Driving tips ..... 124
    - Fuel gauge ..... 32
    - Grade (gasoline) ..... 284
    - Important safety notes ..... 284
    - Premium-grade unleaded gaso-  
line ..... 284
    - Problem (malfunction) ..... 122
    - Refueling ..... 120
    - Tank content/reserve fuel ..... 284
  - Fuel filler flap**
    - Closing ..... 121
    - Emergency release ..... 121
    - Opening ..... 120
  - Fuel level**
    - Calling up the range (on-board computer) ..... 163
  - Fuel tank**
    - Capacity ..... 284
    - Problem (malfunction) ..... 122
  - Fuse allocation chart** ..... 255
  - Fuse box**
    - cargo compartment ..... 256
    - Dashboard ..... 255
    - Front-passenger footwell ..... 255
    - Transmission tunnel ..... 255
  - Fuses**
    - Allocation chart ..... 255
    - Before changing ..... 254
    - Dashboard fuse box ..... 255
    - Fuse allocation chart ..... 255
    - Fuse box in the cargo compart-  
ment ..... 256
    - Fuse box in the front-passenger  
footwell ..... 255
    - Fuse box in the transmission tun-  
nel ..... 255
    - Important safety notes ..... 254
- G**
- Garage door opener**
    - Clearing the memory ..... 229
    - General notes ..... 226
    - Important safety notes ..... 227
    - Opening/closing the garage door .. 229
    - Problems when programming ..... 229
    - Programming the remote control ... 227
    - Synchronizing the rolling code ..... 228
  - Gasoline** ..... 284
  - Gear indicator (on-board com-  
puter)** ..... 171

<b>Genuine parts</b> .....	23
<b>Glove box</b> .....	210
<b>Google™ Local Search</b> see also Digital Operator's Manual .....	203
<b>GTW (Gross Trailer Weight) (definition)</b> .....	274
<b>H</b>	
<b>Hazard warning lamps</b> .....	88
<b>Head restraints</b> Adjusting .....	76
Adjusting (rear) .....	77
Installing/removing (rear) .....	77
Luxury .....	76
Resetting (front) .....	76
see NECK-PRO head restraints	
see NECK-PRO luxury head restraints	
<b>Headlamps</b> Cleaning system (function) .....	87
Cleaning system (notes) .....	287
Fogging up .....	88
Protective grille .....	91
see Automatic headlamp mode	
<b>Heating</b> see Climate control	
<b>High beam flasher</b> .....	88
<b>High-beam headlamps</b> Display message .....	180
Switching on/off .....	88
<b>Hill start assist</b> .....	107
<b>HOLD function</b> Activating .....	143
Activation conditions .....	143
Deactivating .....	143
Function/notes .....	142
General notes .....	142
<b>Home address</b> see also Digital Operator's Manual .....	203
<b>Hood</b> Closing .....	231
Display message .....	190
Important safety notes .....	230
Opening .....	230
<b>Horn</b> .....	31
<b>Hydroplaning</b> .....	127

**I**

<b>Ignition lock</b> see Key positions	
<b>Immobilizer</b> .....	62
<b>Indicator lamp</b> Replacing bulbs (rear) .....	92
<b>Insect protection on the radiator</b> ....	231
<b>Instrument cluster</b> Overview .....	32
Warning and indicator lamps .....	32
<b>Instrument cluster lighting</b> .....	160
<b>Interior lighting</b> Automatic control .....	89
Delayed switch-off (on-board computer) .....	169
Overview .....	89
<b>iPod®</b> see also Digital Operator's Manual .....	203

**J**

<b>Jack</b> Pump lever .....	276
Storage location .....	244
Using .....	276
<b>Jump starting (engine)</b> .....	249

**K**

<b>Key positions</b> SmartKey .....	105
--	-----

**L**

<b>Language (on-board computer)</b> .....	168
<b>Lap time (RACETIMER)</b> .....	172
<b>LATCH-type (ISOFIX) child seat anchors</b> .....	52
<b>License plate lamp (display message)</b> .....	180
<b>Light sensor (display message)</b> .....	180
<b>Lights</b> Activating/deactivating the interior lighting delayed switch-off .....	169
Automatic headlamp mode .....	87
Combination switch .....	88
Fogged up headlamps .....	88

- General notes ..... 86
- Hazard warning lamps ..... 88
- High beam flasher ..... 88
- High-beam headlamps ..... 88
- Light switch ..... 86
- Low-beam headlamps ..... 86
- Parking lamps ..... 87
- Rear fog lamp ..... 87
- Standing lamps ..... 87
- Switching the daytime running lamps on/off (on-board computer) ..... 169
- Switching the daytime running lamps on/off (switch) ..... 86
- Switching the exterior lighting delayed switch-off on/off (on-board computer) ..... 169
- Switching the surround lighting on/off (on-board computer) ..... 169
- Turn signals ..... 88
- see Interior lighting
- see Replacing bulbs
- Load anchorage** ..... 213
- Loading guidelines** ..... 209
- Locking**
- see Central locking
- Locking (doors)**
- Automatic ..... 67
- Emergency locking ..... 68
- From inside (central locking button) ..... 67
- Locking centrally**
- see Central locking
- Locking verification signal (on-board computer)** ..... 170
- LOW RANGE off-road gear** ..... 149
- Low-beam headlamps**
- Display message ..... 180
- Switching on/off ..... 86
- Lumbar support**
- Adjusting the 4-way lumbar support ..... 78
- Luxury head restraints** ..... 76
- M**
- M+S tires** ..... 259
- Malfunction message**
- see Display messages
- Matte finish (cleaning instructions)** ..... 238
- mbrace**
- Call priority ..... 223
- Display message ..... 177
- Downloading destinations (COMAND) ..... 223
- Downloading routes ..... 226
- Emergency call ..... 220
- General notes ..... 219
- Geo fencing ..... 226
- Info call button ..... 222
- Locating a stolen vehicle ..... 225
- Remote fault diagnosis ..... 225
- Remote vehicle locking ..... 224
- Roadside assistance button ..... 221
- Search & Send ..... 223
- Self-test ..... 220
- Speed alert ..... 226
- System ..... 220
- Triggering the vehicle alarm ..... 226
- Vehicle remote unlocking ..... 224
- Mechanical key**
- Function/notes ..... 64
- General notes ..... 64
- Inserting ..... 64
- Locking vehicle ..... 68
- Removing ..... 64
- Unlocking the driver's door ..... 68
- Memory card (audio)** ..... 165
- Memory function** ..... 84
- Mercedes-Benz Intelligent Drive**
- DISTRONIC PLUS ..... 134
- Message memory (on-board computer)** ..... 174
- Messages**
- see Display messages
- Mirror turn signal**
- Cleaning ..... 239
- Mirrors**
- Sun visor ..... 216
- see Exterior mirrors
- see Rear-view mirror

**Mobile phone**

- Connecting (Bluetooth® inter-  
face) ..... 206
- Frequencies ..... 281
- Installation ..... 281
- Menu (on-board computer) ..... 166
- Transmission output (maximum) .... 281

**Modifying the programming**

- (SmartKey)** ..... 64

**Mounting wheels**

- Lowering the vehicle ..... 278
- Mounting a new wheel ..... 278
- Preparing the vehicle ..... 276
- Raising the vehicle ..... 276
- Removing a wheel ..... 278
- Securing the vehicle against roll-  
ing away ..... 276

**MP3**

- Operation ..... 165
- see also Digital Operator's Man-  
ual ..... 203
- see separate operating instructions

**Multifunction display**

- Function/notes ..... 162
- Permanent display ..... 168

**Multifunction steering wheel**

- Operating the on-board computer .. 161
- Overview ..... 33

**Multimedia system**

- Switching on and off ..... 204

**Music files**

- see also Digital Operator's Man-  
ual ..... 203

**N****Navigation**

- Entering a destination ..... 205
- Menu (on-board computer) ..... 164
- see also Digital Operator's Man-  
ual ..... 203
- see separate operating instructions

**NECK-PRO head restraints**

- Operation ..... 48
- Resetting triggered ..... 49

**NECK-PRO luxury head restraints**

- Important safety notes ..... 48
- Operation ..... 48

- Resetting when triggered ..... 49

**Notes on breaking-in a new vehi-**

- cle** ..... 104

**O****Occupant safety**

- Air bags ..... 44
- Automatic measures after an acci-  
dent ..... 50
- BabySmart™ air bag deactivation  
system ..... 53
- Belt warning ..... 43
- Children in the vehicle ..... 50
- Important safety notes ..... 38
- Introduction to the restraint sys-  
tem ..... 38
- PASSENGER AIR BAG indicator  
lamps ..... 39
- Pets in the vehicle ..... 57
- Restraint system warning lamp ..... 38
- Seat belt ..... 39

**Odometer**

- ..... 163

**Off-road**

- Differential locks ..... 151
- Off-road ABS ..... 59

**Off-road driving**

- Checklist after driving off-road ..... 131
- Checklist before driving off-road .... 130
- Driving on sand ..... 131
- General information ..... 130
- Important safety notes ..... 129
- Traveling uphill ..... 132

**Off-road fording**

- ..... 128

**Off-road system**

- Permanent all-wheel drive ..... 143

**Oil**

- see Engine oil

**On-board computer**

- AMG menu ..... 171
- Assistance menu ..... 167
- Audio menu ..... 165
- Convenience submenu ..... 170
- Display messages ..... 173
- DISTRONIC PLUS ..... 139
- Factory settings submenu ..... 171
- Important safety notes ..... 160
- Instrument cluster submenu ..... 168

- Lighting submenu ..... 169
  - Menu overview ..... 162
  - Message memory ..... 174
  - Navigation menu ..... 164
  - Operation ..... 161
  - RACETIMER ..... 172
  - Selecting the language ..... 168
  - Service menu ..... 167
  - Settings menu ..... 168
  - Standard display ..... 163
  - Telephone menu ..... 166
  - Time ..... 169
  - Time/Date submenu ..... 168
  - Trip menu ..... 163
  - TV operation ..... 166
  - Vehicle submenu ..... 170
  - Video DVD operation ..... 166
  - Operating safety**
    - Declaration of conformity ..... 26
    - Important safety notes ..... 26
  - Operating system**
    - see On-board computer
  - Operation**
    - Digital Operator's Manual ..... 22
  - Operator's Manual**
    - Vehicle equipment ..... 24
  - Outside temperature display** ..... 160
  - Overhead control panel** ..... 36
  - Override feature**
    - Rear side windows ..... 57
- P**
- Paint code number** ..... 282
  - Paintwork (cleaning instructions) ...** 238
  - Panic alarm** ..... 38
  - Parking**
    - Engaging park position ..... 112
    - Important safety notes ..... 122
    - Parking brake ..... 123
    - Position of exterior mirror, front-passenger side ..... 83
    - Rear view camera ..... 146
    - Switching off the engine ..... 123
    - see PARKTRONIC
  - Parking aid**
    - see Exterior mirrors
    - see PARKTRONIC
  - see Rear view camera
  - Parking brake**
    - Applying ..... 123
    - Display message ..... 176
    - Emergency braking ..... 123
    - Warning lamp ..... 194
  - Parking lamps**
    - Switching on/off ..... 87
  - PARKTRONIC**
    - Deactivating/activating ..... 145
    - Driving system ..... 143
    - Function/notes ..... 143
    - Important safety notes ..... 143
    - Problem (malfunction) ..... 146
    - Range of the sensors ..... 144
    - Trailer towing ..... 145
    - Warning display ..... 145
  - PASSENGER AIR BAG OFF**
    - Indicator lamp ..... 39
    - Problems (malfunctions) ..... 56
  - Permanent all-wheel drive**
    - Off-road system ..... 143
  - Pets in the vehicle** ..... 57
  - Phone book**
    - see also Digital Operator's Manual ..... 203
  - Plastic trim (cleaning instructions)** ..... 241
  - Power supply (trailer)** ..... 159
  - Power washers** ..... 237
  - Program selector button** ..... 115
  - Protection against theft**
    - ATA (Anti-Theft Alarm system) ..... 62
    - Immobilizer ..... 62
  - Protection of the environment**
    - General notes ..... 23
  - Pulling away**
    - Automatic transmission ..... 106
    - General notes ..... 106
    - Hill start assist ..... 107
    - Trailer ..... 107
- Q**
- QR code**
    - Mercedes-Benz Guide App ..... 1
    - Rescue card ..... 28
  - Qualified specialist workshop** ..... 27



## R

- RACE TIMER (on-board computer, Mercedes-AMG vehicles)** ..... 172
- RACETIMER**
  - Deleting all laps ..... 172
  - Displaying and starting ..... 172
  - Displaying the intermediate time ... 172
  - Resetting the current lap ..... 172
  - Starting a new lap ..... 172
  - Stopping ..... 172
- Radiator cover** ..... 231
- Radio**
  - Selecting a station ..... 165
- Radio mode**
  - see also Digital Operator's Manual ..... 203
- Radio-wave reception/transmission in the vehicle**
  - Declaration of conformity ..... 26
- Rear bench seat**
  - Folding forward ..... 213
- Rear compartment**
  - Setting the air vents ..... 103
- Rear door**
  - Display message ..... 190
  - Important safety notes ..... 68
- Rear fog lamp**
  - Display message ..... 180
  - Replacing bulbs ..... 92
  - Switching on/off ..... 87
- Rear seat bench**
  - Folding into an upright position .... 213
- Rear view camera**
  - Cleaning instructions ..... 240
  - Coupling up a trailer function ..... 148
  - Display in the multimedia system .. 147
  - Function/notes ..... 146
  - General notes ..... 146
  - Switching on/off ..... 147
- Rear window defroster**
  - Problem (malfunction) ..... 101
  - Switching on/off ..... 101
- Rear window wiper**
  - Replacing the wiper blade ..... 94
  - Switching on/off ..... 94
- Rear-view mirror**
  - Dipping (automatic) ..... 83
- Reflective safety jacket** ..... 243
- Refrigerant (air-conditioning system)**
  - Important safety notes ..... 287
- Refueling**
  - Fuel gauge ..... 32
  - Important safety notes ..... 120
  - Refueling process ..... 120
  - see Fuel
- Remote control**
  - Programming (garage door opener) ..... 227
- Replacing bulbs**
  - Backup lamp ..... 92
  - Brake lamp ..... 92
  - Important safety notes ..... 89
  - Overview of bulb types ..... 90
  - Rear fog lamp ..... 92
  - Tail lamp ..... 92
  - Turn signal (rear) ..... 92
  - Turn signals (front) ..... 91
- Reporting safety defects** ..... 27
- Rescue card** ..... 28
- Reserve (fuel tank)**
  - see Fuel
- Reserve fuel**
  - Display message ..... 183
  - Warning lamp ..... 199
- Residual heat**
  - Switching on/off ..... 102
- Restraint system**
  - Display message ..... 177
  - Introduction ..... 38
  - Warning lamp ..... 198
  - Warning lamp (function) ..... 38
- Reversing lamps (display message)** ..... 180
- Roadside Assistance (breakdown)** .... 25
- Roof lining and carpets (cleaning guidelines)** ..... 242
- Route (navigation)**
  - see Route guidance (navigation)
- Route guidance**
  - see also Digital Operator's Manual ..... 203
- Route guidance (navigation)** ..... 164
- Route guidance active** ..... 164

## S

**Safety**

- Children in the vehicle ..... 50
- see Occupant safety

**Safety system**

- see Driving safety systems

**SD card**

- Inserting ..... 208
- Inserting/removing ..... 208
- Removing ..... 208

**SD memory card**

- see also Digital Operator's Manual ..... 203

**Search & Send**

- see also Digital Operator's Manual ..... 203

**Seat**

- Correct driver's seat position ..... 74

**Seat backrest**

- Folding back ..... 212

**Seat belts**

- Adjusting the height ..... 41
- center rear-compartment seat ..... 42
- Cleaning ..... 242
- Correct usage ..... 41
- Fastening ..... 41
- Important safety guidelines ..... 40
- Introduction ..... 39
- Releasing ..... 43
- Warning lamp ..... 192
- Warning lamp (function) ..... 43

**Seat heating**

- Indicator lamp (malfunction) ..... 79

**Seat ventilation**

- Indicator lamp (malfunction) ..... 79

**Seats**

- Adjusting (electrically) ..... 76
- Adjusting the 4-way lumbar support ..... 78
- Adjusting the head restraint ..... 76
- Cleaning the cover ..... 241
- Important safety notes ..... 74
- Overview ..... 74
- Storing settings (memory function) ..... 84
- Switching seat heating on/off ..... 78
- Switching seat ventilation on/off .... 79

**Selector lever**

- Cleaning ..... 241

**Sensors (cleaning instructions) ..... 239****Service interval display**

- Displaying a service message (on-board computer) ..... 236

**Service menu (on-board com-****puter) ..... 167****Service products**

- Brake fluid ..... 286
- Coolant (engine) ..... 286
- Engine oil ..... 285
- Fuel ..... 283
- Important safety notes ..... 283
- Notes ..... 283
- Refrigerant (air-conditioning system) ..... 287
- Washer fluid ..... 287

**Setting**

- Date ..... 168
- Time ..... 169

**Setting the air distribution ..... 99****Setting the date/time format**

- see also Digital Operator's Manual ..... 203

**Setting the language**

- see also Digital Operator's Manual ..... 203

**Setting the time**

- see also Digital Operator's Manual ..... 203

**Settings**

- Calling up a stored setting ..... 85
- Factory (on-board computer) ..... 171
- Language ..... 168
- On-board computer ..... 168

**SETUP (on-board computer,****Mercedes-AMG vehicles) ..... 171****Shift ranges ..... 116****Side impact air bag ..... 45****Side marker lamp (display message) ..... 180****Side windows**

- Convenience closing feature ..... 70
- Convenience opening feature ..... 70
- Important safety information ..... 69
- Opening/closing ..... 69

- Overview ..... 69
- Problem (malfunction) ..... 70
- SIRIUS services**
- see also Digital Operator's Manual ..... 203
- Sliding sunroof**
- Important safety notes ..... 71
- Opening/closing ..... 72
- Operating manually ..... 72
- Problem (malfunction) ..... 73
- SmartKey**
- Changing the battery ..... 65
- Changing the programming ..... 64
- Checking the battery ..... 65
- Convenience closing feature ..... 70
- Convenience opening feature ..... 70
- Display message ..... 191
- Door central locking/unlocking ..... 63
- Important safety notes ..... 63
- Loss ..... 66
- Mechanical key ..... 64
- Overview ..... 63
- Positions (ignition lock) ..... 105
- Problem (malfunction) ..... 66
- Starting the engine ..... 106
- SMS**
- see also Digital Operator's Manual ..... 203
- Snow chains** ..... 259
- Socket (12 V)**
- Cargo compartment ..... 218
- Front-passenger footwell ..... 217
- General notes ..... 217
- Rear compartment ..... 218
- Sound**
- Switching on/off ..... 204
- Spare fuses** ..... 255
- Spare wheel**
- Important safety notes ..... 279
- Spare wheel bracket at the rear .... 245
- Stainless-steel spare hub cap ..... 245
- Special seat belt retractor** ..... 50
- Specialist workshop** ..... 27
- Speedometer**
- Digital ..... 163
- In the Instrument cluster ..... 32
- Segments ..... 160
- Selecting the display unit ..... 168
- Standing lamps**
- Display message ..... 180
- Switching on/off ..... 87
- Starting the engine**
- Important safety notes ..... 106
- Steering (display message)** ..... 191
- Steering wheel**
- Adjusting (electrically) ..... 80
- Buttons (on-board computer) ..... 161
- Cleaning ..... 241
- Important safety notes ..... 79
- Paddle shifters ..... 116
- Steering wheel heating ..... 80
- Storing settings (memory function) ..... 84
- Steering wheel heating**
- Indicator lamp (malfunction) ..... 81
- Steering wheel paddle shifters** ..... 116
- Stopwatch (RACETIMER)** ..... 172
- Stowage areas** ..... 210
- Stowage compartment**
- Door stowage compartment ..... 211
- Stowage compartments**
- Armrest (under) ..... 211
- Cup holders ..... 215
- Glove box ..... 210
- Important safety information ..... 210
- Stowage net ..... 211
- Stowage pockets ..... 211
- Stowage net** ..... 211
- Summer opening**
- see Convenience opening feature
- Summer tires**
- In winter ..... 259
- Sun visor** ..... 215
- Surround lighting (on-board computer)** ..... 169
- SUV**
- (Sport Utility Vehicle) ..... 26
- Switching air-recirculation mode on/off** ..... 102
- Switching on media mode**
- Via the device list ..... 208

## T

- Tachometer** ..... 160

- Tail lamp**
- Replacing bulbs ..... 92
- Tail lamps**
- Display message ..... 180
- Tank content**
- Fuel gauge ..... 32
- Technical data**
- Capacities ..... 283
- Drawbar load (maximum) ..... 291
- Information ..... 281
- Trailer loads ..... 291
- Vehicle data ..... 288
- Telephone**
- Accepting a call ..... 166
- Authorizing a mobile phone (connecting) ..... 207
- Connecting a mobile phone (general information) ..... 206
- Display message ..... 191
- Menu (on-board computer) ..... 166
- Number from the phone book ..... 167
- Redialing ..... 167
- Rejecting/ending a call ..... 166
- see also Digital Operator's Manual ..... 203
- see Mobile phone
- Temperature**
- Coolant ..... 161
- Coolant (on-board computer) ..... 171
- Engine oil (on-board computer) ..... 171
- Outside temperature ..... 160
- Setting (climate control) ..... 99
- Tilt/sliding sunroof**
- see Sliding sunroof
- Time**
- see separate operating instructions
- Timing (RACETIMER) ..... 172**
- Tire pressure**
- Calling up (on-board computer) ..... 263
- Checking manually ..... 263
- Display message ..... 187
- Maximum ..... 262
- Notes ..... 261
- Recommended ..... 260
- Tire pressure monitor**
- Checking the tire pressure electronically ..... 264
- Function/notes ..... 263
- General notes ..... 263
- Important safety notes ..... 263
- Radio type approval for the tire pressure monitor ..... 266
- Restarting ..... 265
- Warning lamp ..... 202
- Warning message ..... 265
- Tires**
- Aspect ratio (definition) ..... 275
- Average weight of the vehicle occupants (definition) ..... 273
- Bar (definition) ..... 273
- Changing a wheel ..... 275
- Characteristics ..... 273
- Checking ..... 257
- Curb weight (definition) ..... 274
- Definition of terms ..... 273
- Direction of rotation ..... 276
- Display message ..... 187
- Distribution of the vehicle occupants (definition) ..... 275
- DOT (Department of Transportation) (definition) ..... 273
- DOT, Tire Identification Number (TIN) ..... 272
- GAWR (Gross Axle Weight Rating) (definition) ..... 274
- GTW (Gross Trailer Weight) (definition) ..... 274
- GVW (Gross Vehicle Weight) (definition) ..... 274
- GVWR (Gross Vehicle Weight Rating) (definition) ..... 274
- Important safety notes ..... 257
- Increased vehicle weight due to optional equipment (definition) ..... 274
- Information on driving ..... 257
- Kilopascal (kPa) (definition) ..... 274
- Labeling (overview) ..... 270
- Load bearing index (definition) ..... 275
- Load index ..... 272
- Load index (definition) ..... 274
- Maximum load on a tire (definition) ..... 274
- Maximum loaded vehicle weight (definition) ..... 274
- Maximum permissible tire pressure (definition) ..... 274

Maximum tire load .....	272	Decoupling a trailer .....	158
Maximum tire load (definition) .....	274	Driving tips .....	154
Optional equipment weight (definition) .....	275	ESP® (Electronic Stability Program) .....	61
PSI (pounds per square inch) (definition) .....	275	Important safety notes .....	153
Replacing .....	275	Installing the ball coupling .....	156
Service life .....	258	Lights display message .....	180
Sidewall (definition) .....	275	Pulling away with a trailer .....	107
Snow chains .....	259	Shift range .....	115
Speed rating (definition) .....	274	Trailer loads .....	291
Storing .....	276	Trailer tow hitch .....	291
Structure and characteristics (definition) .....	273	<b>Towing away</b>	
Summer tires in winter .....	259	Important safety guidelines .....	251
Temperature .....	269	In the event of malfunctions .....	253
TIN (Tire Identification Number) (definition) .....	275	With both axles on the ground .....	252
Tire bead (definition) .....	275	<b>Towing eye</b>	
Tire pressure (definition) .....	275	Front .....	252
Tire pressures (recommended) .....	274	Rear .....	252
Tire size (data) .....	279	<b>Traffic reports</b>	
Tire size designation, load-bearing capacity, speed rating .....	270	see also Digital Operator's Manual .....	203
Tire tread .....	258	<b>Trailer</b>	
Tire tread (definition) .....	275	7-pin connector .....	159
Total load limit (definition) .....	275	Power supply .....	159
Traction .....	269	<b>Trailer coupling</b>	
Traction (definition) .....	275	see Towing a trailer	
Tread wear .....	269	<b>Trailer loads</b>	
TWR (permissible trailer drawbar noseweight) (definition) .....	275	Technical data .....	291
Uniform Tire Quality Grading Standards .....	269	<b>Trailer loads and drawbar noseweights</b>	
Uniform Tire Quality Grading Standards (definition) .....	273	Trailer tow hitch .....	159
Wear indicator (definition) .....	275	Ball position .....	291
Wheel and tire combination .....	279	<b>Trailer towing</b>	
Wheel rim (definition) .....	274	PARKTRONIC .....	145
see Flat tire		Permissible trailer loads and drawbar noseweights .....	159
<b>Top Tether</b> .....	52	<b>Transfer case</b>	
<b>Tow-starting</b>		General notes .....	149
Emergency engine starting .....	254	Shift range .....	149
Important safety notes .....	251	Shifting .....	149
<b>Towing a trailer</b>		Shifting (general notes) .....	149
Axle load, permissible .....	291	Shifting (important safety notes) ...	149
Cleaning the trailer tow hitch .....	240	Shifting to neutral .....	150
Coupling up a trailer .....	157	Switching off the off-road gear ratio .....	150
		Switching on the off-road gear ratio .....	149

- Transmission**  
 see Automatic transmission
- Transmission positions** ..... 114
- Transporting the vehicle** ..... 253
- Traveling uphill**  
 Brow of hill ..... 132
- Trim pieces (cleaning instructions)** ..... 241
- Trip computer (on-board computer)** ..... 163
- Trip odometer**  
 Calling up ..... 163  
 Resetting (on-board computer) ..... 163
- Turn signals**  
 Display message ..... 180  
 Replacing bulbs (front) ..... 91  
 Switching on/off ..... 88
- TV**  
 Operating (on-board computer) ..... 166  
 see Separate operating instructions
- Two-way radio**  
 Frequencies ..... 281  
 Installation ..... 281  
 Transmission output (maximum) .... 281
- TWR (Tongue Weight Rating) (definition)** ..... 275
- Type identification plate**  
 see Vehicle identification plate
- U**
- Unlocking**  
 Emergency unlocking ..... 68  
 From inside the vehicle (central unlocking button) ..... 67
- USB devices**  
 Connecting to the Media Interface ..... 208
- V**
- Vanity mirror**  
 Sun visor ..... 216
- Vehicle**  
 Correct use ..... 27  
 Data acquisition ..... 28  
 Display message ..... 190  
 Equipment ..... 24  
 Individual settings ..... 168  
 Limited Warranty ..... 28  
 Loading ..... 266  
 Locking (in an emergency) ..... 68  
 Locking (SmartKey) ..... 63  
 Lowering ..... 278  
 Maintenance ..... 25  
 Operation outside the USA/  
 Canada ..... 25  
 Parking ..... 122  
 Parking for a long period ..... 124  
 Pulling away ..... 106  
 Raising ..... 276  
 Securing from rolling away ..... 276  
 Tow-starting ..... 254  
 Towing ..... 251  
 Transporting ..... 253  
 Unlocking (in an emergency) ..... 68  
 Unlocking (SmartKey) ..... 63  
 Vehicle data ..... 288
- Vehicle data** ..... 288
- Vehicle data (off-road driving)**  
 Approach/departure angle ..... 290  
 Forging depth ..... 290  
 Maximum gradient climbing ability ..... 290
- Vehicle dimensions** ..... 288
- Vehicle emergency locking** ..... 68
- Vehicle identification number**  
 see VIN
- Vehicle identification plate** ..... 282
- Vehicle tool kit** ..... 244
- Ventilation**  
 Setting the airflow ..... 99
- Video**  
 Operating the DVD ..... 166  
 see also Digital Operator's Manual ..... 203
- VIN**  
 Type plate ..... 282
- W**
- Warning and indicator lamps**  
 ABS ..... 194  
 Brakes ..... 193  
 Check Engine ..... 199  
 Coolant ..... 199

Distance warning .....	201	<b>Windshield washer system</b>	
DISTRONIC PLUS .....	201	Adding washer fluid .....	234
ESP® .....	196	Notes .....	287
ESP® OFF .....	197	<b>Windshield wipers</b>	
Fuel tank .....	199	Problem (malfunction) .....	95
General notes .....	191	Rear window wiper .....	94
Overview .....	32	Replacing the wiper blades .....	94
Parking brake .....	194	Switching on/off .....	93
PASSENGER AIR BAG OFF .....	39	<b>Winter driving</b>	
Reserve fuel .....	199	Important safety notes .....	258
Restraint system .....	198	Slippery road surfaces .....	128
Seat belt .....	192	Snow chains .....	259
Tire pressure monitor .....	202	<b>Winter operation</b>	
<b>Warning triangle</b> .....	243	Overview .....	258
<b>Warranty</b> .....	24	Radiator cover .....	231
<b>Washer fluid</b>		Summer tires .....	259
Display message .....	191	<b>Winter tires</b>	
<b>Weather display (COMAND)</b>		M+S tires .....	259
see also Digital Operator's Manual .....	203	<b>Wiper blades</b>	
<b>Wheel and tire combinations</b>		Cleaning .....	239
Tires .....	279	Important safety notes .....	94
<b>Wheel bolt tightening torque</b> .....	278	Replacing .....	94
<b>Wheels</b>		<b>Wooden trim (cleaning instructions)</b> .....	241
Changing a wheel .....	275		
Checking .....	257		
Cleaning .....	238		
Important safety notes .....	257		
Information on driving .....	257		
Interchanging/changing .....	275		
Mounting a new wheel .....	278		
Mounting a wheel .....	276		
Removing a wheel .....	278		
Snow chains .....	259		
Storing .....	276		
Tightening torque .....	278		
Wheel size/tire size .....	279		
<b>Window curtain air bag</b>			
Display message .....	178		
Operation .....	46		
<b>Windows</b>			
see Side windows			
<b>Windshield</b>			
Defrosting .....	100		
<b>Windshield heating</b> .....	101		
<b>Windshield washer fluid</b>			
see Windshield washer system			

## Introduction

The printed Operator's Manual provides information about the safe operation of your vehicle. The Digital Operator's Manual provides comprehensive and specifically adapted information on your vehicle's equipment and multimedia system. You can call up the Digital Operator's Manual via the multimedia system.

- i** You will not incur any costs when calling up the Digital Operator's Manual. The Digital Operator's Manual works without connecting to the Internet.

There are three ways to access the topics of the Digital Operator's Manual:

### • Visual search

The visual search allows you to explore your vehicle "virtually". Starting from either the vehicle exterior view or interior view, you can access many of the different topics covered by the Digital Operator's Manual. To access the vehicle interior section, select the "Vehicle interior" view.

### • Keyword search

The keyword search allows you to search for a keyword by entering characters.



### • Contents

You can select individual sections in the contents.

- i** The Digital Operator's Manual is deactivated for safety reasons while driving.

## Operation

### Calling up the Digital Operator's Manual

- ▶ Press the  button on the center console. The overview relating to the vehicle appears.
- ▶ Select the "Operator's Manual" menu item by turning  or pressing  the controller.
- ▶ Confirm  the message about the warning and safety notes. The menu for the Digital Operator's Manual appears.

## Operating the Digital Operator's Manual





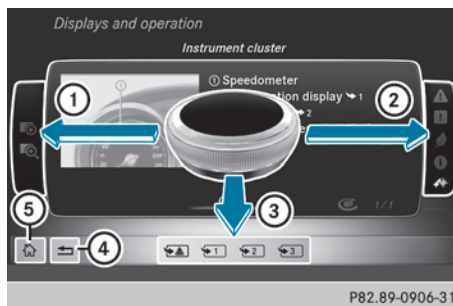

### General notes

Please observe the information about the operation of the controller (▷ page 204).

### Content pages

The content pages can be accessed by means of a visual search, a keyword search or using the contents.



- ▶ **To scroll forward/back:** turn  the controller.
- ▶ **To display in full-screen or animation:** slide  the controller to the left **1**.
- ▶ **To select information text or save bookmarks:** slide  the controller to the right **2**.
- ▶ **To select a link:** slide  the controller down **3**.
- ▶ **To exit a content page:** select the  symbol **4**.
- ▶ **To call up the menu of the Digital Operator's Manual:** select  symbol **5**.
- ▶ **To switch functions to the multimedia system using the buttons on the center console:** press the **RADIO**, **TEL**, **MEDIA** or **NAVI** button.  
The selected menu appears. The Digital Operator's Manual remains open in the background.



## Protecting the environment

### General notes

#### Environmental note

Daimler's declared policy is one of comprehensive environmental protection.

The objectives are for the natural resources that form the basis of our existence on this planet to be used sparingly and in a manner that takes the requirements of both nature and humanity into account.

You too can help to protect the environment by operating your vehicle in an environmentally responsible manner.

Fuel consumption and the rate of engine, transmission, brake and tire wear are affected by these factors:

- operating conditions of your vehicle
- your personal driving style

You can influence both factors. You should bear the following in mind:

Operating conditions:

- avoid short trips as these increase fuel consumption.
- always make sure that the tire pressures are correct.
- do not carry any unnecessary weight.
- remove roof racks once you no longer need them.
- a regularly serviced vehicle will contribute to environmental protection. You should therefore adhere to the service intervals.
- always have service work carried out at a qualified specialist workshop.

Personal driving style:

- do not depress the accelerator pedal when starting the engine.
- do not warm up the engine when the vehicle is stationary.
- drive carefully and maintain a safe distance from the vehicle in front.
- avoid frequent, sudden acceleration and braking.

- change gear in good time and use each gear only up to  $\frac{2}{3}$  of its maximum engine speed.
- switch off the engine in stationary traffic.
- keep an eye on the vehicle's fuel consumption.

### Environmental concerns and recommendations

Wherever the Operator's Manual requires you to dispose of materials, first try to regenerate or reuse them. Observe the relevant environmental rules and regulations when disposing of materials. In this way you will help to protect the environment.

## Genuine Mercedes-Benz parts

#### Environmental note

Daimler AG also supplies reconditioned major assemblies and parts which are of the same quality as new parts. They are covered by the same Limited Warranty entitlements as new parts.

**!** Air bags and Emergency Tensioning Devices, as well as control units and sensors for these restraint systems, may be installed in the following areas of your vehicle:

- doors
- door pillars
- door sills
- seats
- cockpit
- instrument cluster
- center console

Do not install accessories such as audio systems in these areas. Do not carry out repairs or welding. You could impair the operating efficiency of the restraint systems.

Have aftermarket accessories installed at a qualified specialist workshop.

You could jeopardize the operating safety of your vehicle if you use parts, tires and wheels as well as accessories relevant to safety which have not been approved by Mercedes-Benz. This could lead to malfunctions in safety-relevant

systems, e.g. the brake system. Use only genuine Mercedes-Benz parts or parts of equal quality. Only use tires, wheels and accessories that have been specifically approved for your vehicle.

Genuine Mercedes-Benz parts are subject to strict quality control. Every part has been specifically developed, manufactured or selected for and adapted to Mercedes-Benz vehicles. Therefore, only genuine Mercedes-Benz parts should be used.

More than 300,000 different genuine Mercedes-Benz parts are available for Mercedes-Benz models.

All authorized Mercedes-Benz Centers maintain a supply of genuine Mercedes-Benz parts for necessary service and repair work. In addition, strategically located parts delivery centers provide quick and reliable parts service.

Always specify the vehicle identification number (VIN) when ordering genuine Mercedes-Benz parts (> page 282).

## Operator's Manual

### Vehicle equipment

**i** This Operator's Manual describes all models and all standard and optional equipment of your vehicle available at the time of publication of the Operator's Manual. Country-specific differences are possible. Bear in mind that your vehicle may not feature all functions described here. This also applies to safety-relevant systems and functions. The equipment in your vehicle may therefore differ from that shown in the descriptions and illustrations.

The original purchase agreement lists all systems installed in your vehicle.

Should you have any questions concerning equipment and operation, please consult an authorized Mercedes-Benz Center.

The Operator's Manual and Maintenance Booklet are important documents and should be kept in the vehicle.

## Service and vehicle operation

### Warranty

The Limited Warranty for your vehicle applies in accordance with the warranty terms and conditions in the Service and Warranty Information booklet.

Your authorized Mercedes-Benz Center will replace and repair all factory-installed parts in accordance with the following warranty terms and conditions:

- New Vehicle Limited Warranty
- Emission System Warranty
- Emission Performance Warranty
- California, Connecticut, Maine, Massachusetts, New York, Pennsylvania, Rhode Island and Vermont Emission Control System Warranty
- State warranty enforcement laws (lemon laws)

Replacement parts and accessories are covered by the Mercedes-Benz Parts and Accessories warranties. These are available at any authorized Mercedes-Benz Center.

**i** Should you lose your Service and Warranty Information booklet, have an authorized Mercedes-Benz Center arrange for a replacement. The new Service and Warranty Information booklet will be posted to you.

### Information for customers in California

Under California law you may be entitled to a replacement of your vehicle or a refund of the purchase price or lease price, if after a reasonable number of repair attempts Mercedes-Benz USA, LLC and/or its authorized repair or service facilities fail to fix one or more substantial defects or malfunctions in the vehicle that are covered by its express warranty.

During the period of 18 months from original delivery of the vehicle or the accumulation of 18,000 miles (approximately 29,000 km) on the odometer of the vehicle, whichever occurs first, a reasonable number of repair attempts is presumed for a retail buyer or lessee if one or more of the following occurs:

- (1) the substantial defect or malfunction can result in death or serious injuries for the

vehicle occupants while driving and this defect has already been repaired at least twice and Mercedes-Benz, LLC has been informed in writing of the necessity of a repair.

- (2) the defect or malfunction, though less serious than (1) above, has already been repaired at least four times and Mercedes-Benz has been informed in writing of the necessity of a repair.
- (3) the vehicle cannot be used for longer than 30 calendar days because of repair work resulting from this or other substantial defects or malfunctions.

Please send your written notice to:  
Mercedes-Benz USA, LLC  
Customer Assistance Center  
3 Mercedes Drive  
Montvale, NJ 07645-0350

### Maintenance

Always bring the Maintenance Booklet with you when taking the vehicle to an authorized Mercedes-Benz Center. Your customer service advisor will enter every service into your Maintenance Booklet on your behalf.

### Roadside Assistance

The Mercedes-Benz Roadside Assistance Program offers technical help in the event of a breakdown. Calls to the toll-free Roadside Assistance Hotline are answered by our agents 24 hours a day, 365 days a year.

**1-800-FOR-MERCEdes (1-800-367-6372)  
(USA)**

**1-800-387-0100 (Canada)**

For additional information, refer to the Mercedes-Benz Roadside Assistance Program brochure (USA) or the "Roadside Assistance" section in the Service and Warranty Booklet (Canada). You will find both in the vehicle document wallet.

### Change of address or change of ownership

In the event of a change of address, please send us the "Notification of Address Change" in the

Service and Warranty Booklet or simply call the Mercedes-Benz Customer Assistance Center (USA) at the hotline number 1-800-FOR-MERCEdes (1-800-367-6372) or Customer Service Center (Canada) at 1-800-387-0100. This will assist us in contacting you in a timely manner should the need arise.

If you sell your Mercedes, please leave all literature in the vehicle so that it is available to the next owner.

If you have purchased a used car, please send us the "Notification of Used Car Purchase" in the Service and Warranty Booklet or simply call the Mercedes-Benz Customer Assistance Center (USA) at the hotline number 1-800-FOR-MERCEdes (1-800-367-6372) or Customer Service (Canada) at 1-800-387-0100.

### Vehicle operation outside the USA and Canada

When you are abroad with your vehicle, observe the following points:

- Service facilities or replacement parts may not be readily available.
- Lead-free fuel for vehicles with a catalytic converter may not be available. Leaded fuel can cause damage to the catalytic converter.
- The fuel may have a considerably lower octane number. Unsuitable fuel can cause engine damage.

Some Mercedes-Benz models are available for delivery in Europe through our European Delivery Program. For details, consult an authorized Mercedes-Benz Center or write to one of the following addresses.

#### In the USA

Mercedes-Benz USA, LLC  
European Delivery Department  
One Mercedes Drive  
Montvale, NJ 07645-0350

#### In Canada

Mercedes-Benz Canada, Inc.  
European Delivery Department  
98 Vanderhoof Avenue  
Toronto, Ontario M4G 4C9

### Sports Utility Vehicle

#### WARNING

Due to the high center of gravity, the vehicle may start to skid and roll over in the event of an abrupt steering maneuver and/or when the vehicle's speed is not adapted to the road conditions. There is a risk of an accident.

Always adapt your speed and driving style to the vehicle's driving characteristics and to the prevailing road and weather conditions.

Utility vehicles have a significantly higher roll-over rate than other types of vehicles.

Failure to operate this vehicle safely may result in an accident, rollover of the vehicle, and severe or fatal injury.

In a rollover crash, an unbelted person is significantly more likely to die than a person wearing a seat belt.

You and all vehicle occupants should always wear your seat belts.

### Operating safety

#### Important safety notes

#### WARNING

If you do not have the prescribed service/maintenance work or any required repairs carried out, this can result in malfunctions or system failures. There is a risk of an accident. Always have the prescribed service/maintenance work as well as any required repairs carried out at a qualified specialist workshop.

#### WARNING

Flammable material such as leaves, grass or twigs may ignite if they come into contact with hot parts of the exhaust system. There is a risk of fire.

When driving off road or on unpaved roads, check the vehicle's underside regularly. In particular, remove parts of plants or other flammable materials which have become trapped. In the case of damage, contact a qualified specialist workshop.

#### WARNING

Modifications to electronic components, their software as well as wiring can impair their function and/or the function of other networked components. In particular, systems relevant to safety could also be affected. As a result, these may no longer function as intended and/or jeopardize the operating safety of the vehicle. There is an increased risk of an accident and injury.

Never tamper with the wiring as well as electronic components or their software. You should have all work to electrical and electronic equipment carried out at a qualified specialist workshop.

 There is a risk of damage to the vehicle if:

- the vehicle becomes stuck, e.g. on a high curb or an unpaved road
- you drive too fast over an obstacle, e.g. a curb, a speed bump or a pothole in the road
- a heavy object strikes the underbody or parts of the chassis

In situations like this, the body, the underbody, chassis parts, wheels or tires could be damaged without the damage being visible. Components damaged in this way can unexpectedly fail or, in the case of an accident, no longer withstand the loads they are designed to.

If the underbody paneling is damaged, combustible materials such as leaves, grass or twigs can gather between the underbody and the underbody paneling. If these materials come in contact with hot parts of the exhaust system, they can catch fire.

In such situations, have the vehicle checked and repaired immediately at a qualified specialist workshop. If on continuing your journey you notice that driving safety is impaired, pull over and stop the vehicle immediately, paying attention to road and traffic conditions. In such cases, consult a qualified specialist workshop.

#### Declaration of conformity for wireless vehicle components

**USA:** "The wireless devices of this vehicle comply with Part 15 of the FCC Rules. Operation is

subject to the two following two conditions: 1) These devices may not cause harmful interference, and 2) These devices must accept any interference received, including interference that may cause undesired operation. Changes or modifications not expressly approved by the party responsible for compliance could void the user's authority to operate the equipment."

**Canada:** "The wireless devices of this vehicle comply with Industry Canada license-exempt RSS standard(s). Operation is subject to the following two conditions: (1) These devices may not cause interference, and (2) These devices must accept any interference, including interference that may cause undesired operation of the device."

### Diagnostics connection

The diagnostics connection is only intended for the connection of diagnostic equipment at a qualified specialist workshop.

#### WARNING

If you connect equipment to a diagnostics connection in the vehicle, it may affect the operation of vehicle systems. As a result, the operating safety of the vehicle could be affected. There is a risk of an accident.

Only connect equipment to a diagnostics connection in the vehicle, which is approved for your vehicle by Mercedes-Benz.

#### WARNING

Objects in the driver's footwell may restrict the clearance around the pedals or block a depressed pedal. This jeopardizes the operating and road safety of the vehicle. There is a risk of an accident.

Stow all objects securely in the vehicle so that they do not get into the driver's footwell.

When using floor mats or carpets, make sure that they are properly secured so that they do not slip or obstruct the pedals. Do not place several floor mats or carpets on top of one another.

**!** If the engine is switched off and equipment on the diagnostics connection is used, the starter battery may discharge.

Connecting equipment to the diagnostics connection can lead to emissions monitoring information being reset, for example. This may lead to the vehicle failing to meet the requirements of the next emissions test during the main inspection.

### Qualified specialist workshop

An authorized Mercedes-Benz Center is a qualified specialist workshop. It has the necessary specialist knowledge, tools and qualifications to correctly carry out the work required on your vehicle. This is especially the case for work relevant to safety.

Observe the notes in the Maintenance Booklet. Always have the following work carried out at an authorized Mercedes-Benz Center:

- work relevant to safety
- service and maintenance work
- repair work
- alterations, installation work and modifications
- work on electronic components

### Correct use

If you remove any warning stickers, you or others could fail to recognize certain dangers. Leave warning stickers in position.

Observe the following information when driving your vehicle:

- the safety notes in this manual
- technical data for the vehicle
- traffic rules and regulations
- laws and safety standards pertaining to motor vehicles

### Reporting safety defects

USA only:

The following text is reproduced as required of all manufacturers under Title 49, Code of U.S. Federal Regulations, Part 575 pursuant to the National Traffic and Motor Vehicle Safety Act of 1966.

If you believe that your vehicle has a defect which could cause a crash or could cause injury or death, you should immediately inform the

National Highway Traffic Safety Administration (NHTSA) in addition to notifying Mercedes-Benz USA, LLC.

If NHTSA receives similar complaints, it may open an investigation, and if it finds that a safety defect exists in a group of vehicles, it may order a recall and remedy campaign. However, NHTSA cannot become involved in individual problems between you, your dealer, or Mercedes-Benz USA, LLC.

To contact NHTSA, you may call the Vehicle Safety Hotline toll-free at 1-888-327-4236 (TTY: 1-800-424-9153); go to <http://www.safercar.gov>; or write to: Administrator, NHTSA, 400 Seventh Street, SW., Washington, DC 20590.

You can also obtain other information about motor vehicle safety from

<http://www.safercar.gov>

### Limited Warranty

**!** Follow the instructions in this manual about the proper operation of your vehicle as well as about possible vehicle damage. Damage to your vehicle that arises from culpable contraventions against these instructions is not covered either by the Mercedes-Benz Limited Warranty or by the New or Used-Vehicle Warranty.

### QR codes for rescue cards

The QR codes are secured in the fuel filler flap and on the opposite side on the B-pillar. In the event of an accident, rescue services can use the QR code to quickly find the appropriate rescue card for your vehicle. The current rescue card contains the most important information about your vehicle in a compact form, e.g. the routing of the electric cables.

You can find more information under [www.mercedes-benz.de/qrcode](http://www.mercedes-benz.de/qrcode).

### Data stored in the vehicle

#### Data storage

A wide range of electronic components in your vehicle contain data memories.

These data memories temporarily or permanently store technical information about:

- the vehicle's operating state
- incidents
- malfunctions

In general, this technical information documents the state of a component, a module, a system or the surroundings.

This includes, for example:

- operating conditions of system components. For example, fluid levels
- the vehicle's status messages and those of its individual components, e.g. number of wheel revolutions/speed, deceleration in movement, lateral acceleration, accelerator pedal position
- malfunctions and defects in important system components, e.g. lights, brakes
- vehicle reactions and operating conditions in special driving situations, e.g. air bag deployment, intervention of stability control systems
- ambient conditions, e.g. outside temperature

This data is of an exclusively technical nature and can be used to:

- assist in recognizing and rectifying malfunctions and defects
- analyze vehicle functions, e.g. after an accident
- optimize vehicle functions

The data cannot be used to trace the vehicle's movements.

When your vehicle is serviced, technical information can be read from the event data memory and malfunction data memory.

Services include, for example:

- repair services
- service processes
- warranties
- quality assurance

The vehicle is read out by employees of the service network (including the manufacturer) using special diagnostic testers. More detailed information is obtained from it, if required.

After a malfunction has been rectified, the information is deleted from the malfunction memory or is continually overwritten.

When operating the vehicle, situations are conceivable in which this technical data, in connec-

tion with other information (if necessary, under consultation with an authorized expert), could be traced to a person.

Examples include:

- accident reports
- damage to the vehicle
- witness statements

Further additional functions that have been contractually agreed upon with the customer allow certain vehicle data to be conveyed by the vehicle as well. The additional functions include, for example, vehicle location in case of an emergency.

### COMAND/mbrace

If the vehicle is equipped with COMAND or mbrace, additional data about the vehicle's operation, the use of the vehicle in certain situations, and the location of the vehicle may be compiled through COMAND or the mbrace system.

For additional information, please refer to the COMAND User Manual or Digital Operator's Manual and/or the mbrace Terms and Conditions.

### Event data recorders

This vehicle is equipped with an event data recorder (EDR). This vehicle is equipped with an event data recorder (EDR). The main purpose of an EDR is to record, in certain crash or near crash-like situations, such as an air bag deployment or hitting a road obstacle, data that will assist in understanding how a vehicle's systems performed. The EDR is designed to record data related to vehicle dynamics and safety systems for a short period of time, typically 30 seconds or less.

The EDR in this vehicle is designed to record such data as:

- How various systems in your vehicle were operating
- Whether or not the driver and passenger safety belts were buckled/fastened
- How far (if at all) the driver was depressing the accelerator and/or brake pedal and
- How fast the vehicle was traveling

These data can help provide a better understanding of the circumstances in which crashes and injuries occur. NOTE: EDR data are recorded by your vehicle only if a non-trivial crash situation occurs; no data are recorded by the EDR under normal driving conditions and no personal data (e.g. name, gender, age and crash location) are recorded. However, other parties, such as law enforcement could combine the EDR data with the type of personally identifying data routinely acquired during a crash investigation.

Access to the vehicle and/or the EDR is needed to read data that is recorded by an EDR, and special equipment is required. In addition to the vehicle manufacturer, other parties that have the special equipment, such as law enforcement, can read the information by accessing the vehicle or the EDR.

EDR data may be used in civil and criminal matters as a tool in accident reconstruction, accident claims and vehicle safety. Since the Crash Data Retrieval CDR tool that is used to extract data from the EDR is commercially available, Mercedes-Benz USA, LLC ("MBUSA") expressly disclaims any and all liability arising from the extraction of this information by unauthorized Mercedes-Benz personnel.

MBUSA will not share EDR data with others without the consent of the vehicle owners or, if the vehicle is leased, without the consent of the lessee. Exceptions to this representation include responses to subpoenas by law enforcement; by federal, state or local government; in connection with or arising out of litigation involving MBUSA or its subsidiaries and affiliates; or, as required by law.

Warning: The EDR is a component of the Restraint System Module. Tampering with, altering, modifying or removing the EDR component may result in a malfunction of the Restraint System Module and other systems.

State laws or regulations regarding EDRs that conflict with federal regulation are pre-empted. This means that in the event of such conflict, the federal regulation governs. As of February 20 13, 13 states have enacted laws relating to EDRs.

### Information on copyright

#### Free and open-source software

Information on license for free and open-source software used in your vehicle can be found on

the data carrier in your vehicle document wallet and, including updates, on the following website:

<http://www.mercedes-benz.com/opensource>

### Registered trademarks

Registered trademarks:

- Bluetooth® is a registered trademark of Bluetooth SIG Inc.
- DTS™ is a registered trademark of DTS, Inc.
- Dolby® and MLP™ are registered trademarks of DOLBY Laboratories.
- BabySmart™, ESP® and PRE-SAFE® are registered trademarks of Daimler AG.
- HomeLink® is a registered trademark of Johnson Controls.
- iPod® and iTunes® are registered trademarks of Apple Inc.
- Logic7® is a registered trademark of Harman International Industries.
- Microsoft® and Windows media® are registered trademarks of Microsoft Corporation.
- SIRIUS® is a registered trademark of Sirius XM Radio Inc.
- HD Radio™ is a registered trademark of iBiquity Digital Corporation.
- Gracenote® is a registered trademark of Gracenote, Inc.
- ZAGAT Survey® and related brands are registered trademarks of Zagat Survey, LLC.



## Cockpit

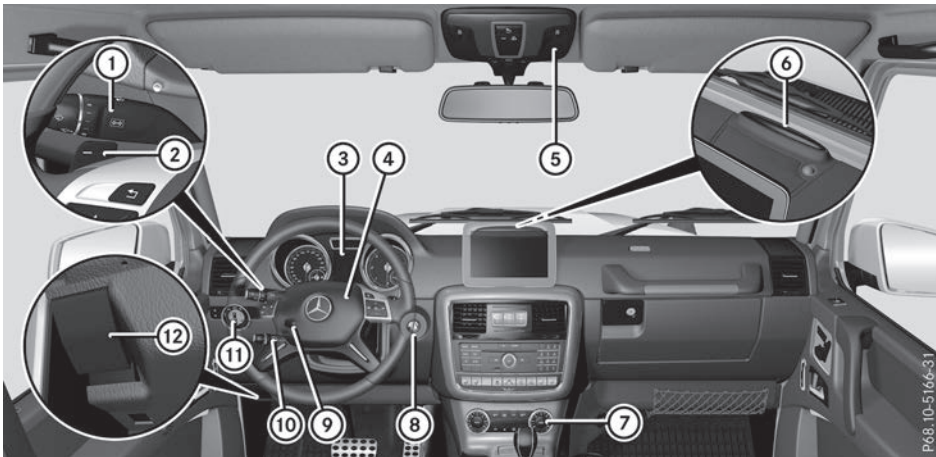

At a glance

	Function	Page		Function	Page
①	Combination switch	88	⑦	Climate control system	96
②	Steering wheel paddle shifters	116	⑧	Ignition lock	105
③	Instrument cluster	32	⑨	Adjusts the steering wheel	79
④	Horn		⑩	Cruise control lever	133
⑤	Overhead control panel	36	⑪	Light switch	86
⑥	PARKTRONIC warning display	143	⑫	Opens the hood	230

## Instrument cluster

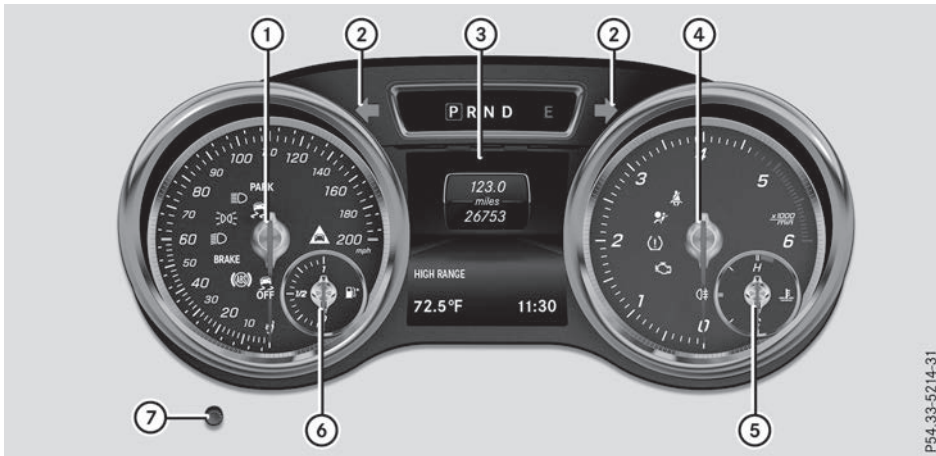

P54.33-5214-31





	Function	Page
①	Speedometer with segments Warning and indicator lamps: ESP® 196 ESP® OFF 196 ABS 194 Brakes (yellow) 193 Low-beam headlamps 86 Parking lamps 87 High-beam headlamps 88 Brakes (red) 193 BRAKE (USA only) Canada only Parking brake PARK (USA only) Distance warning 201	
②	Turn signals 88	
③	Multifunction display 162	







	Function	Page
④	Tachometer Warning and indicator lamps: Rear fog lamp 87 Check Engine 199 Tire pressure monitor 202 Restraint system 38 Seat belts 192	
⑤	Coolant temperature gauge Warning and indicator lamps: Coolant 199	161
⑥	Fuel level indicator Warning and indicator lamps: Reserve fuel with fuel filler flap location indicator (right-hand side) 199	
⑦	Instrument cluster lighting 160	

Multifunction steering wheel



At a glance

	Function	Page
①	Multifunction display	162
②	Multimedia system display	
③	 Switches on the Voice Control System	
④	 Rejects or ends a call Exits the phone book/redial memory  Makes or accepts a call Switches to the redial memory  Adjusts the volume	166

	Function	Page
	 Switches sound on/off	
⑤	  Selects a menu   Selects a submenu or scrolls through lists  Confirms a selection Hides display messages	161 161 161 173
⑥	 Back Switches off the Voice Control System	161

**i** Further information:

- on the multimedia system in the Digital Operator's Manual
- on the Voice Control System in the separate operating instructions

## Center console

## Center console, upper section

At a glance



	Function	Page
①	Multimedia system; see the Digital Operator's Manual	
②	Seat heating	78
③	Seat ventilation	79
④	PARKTRONIC	143
⑤	ECO start/stop function	107





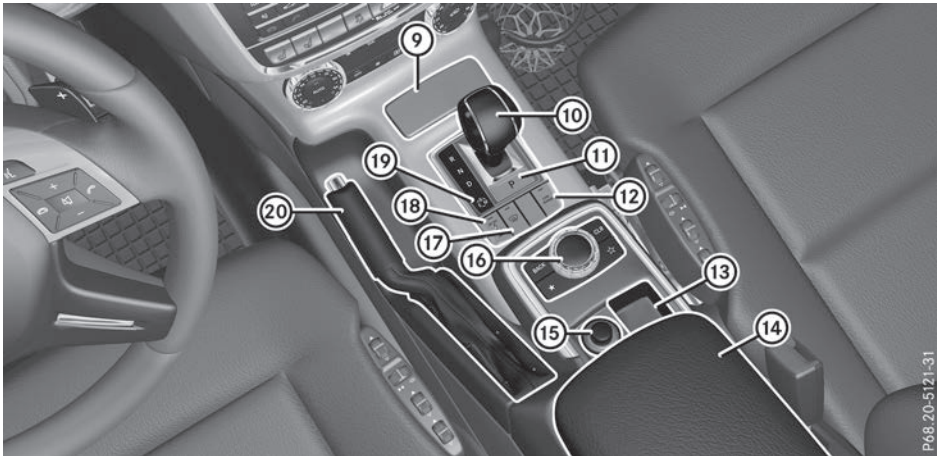



	Function	Page
⑥	Hazard warning lamps	88
⑦	PASSENGER AIR-BAG OFF indicator lamp	39
⑧	ESP®	59

## Center console, lower section



P68 20-5121-31

At a glance





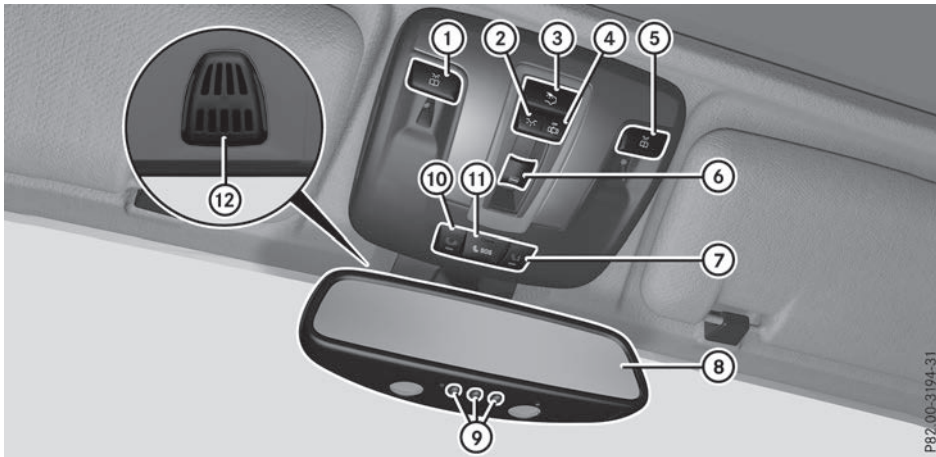

	Function	Page		Function	Page
⑨	Stowage compartment/ ashtray	216	⑬	Stowage compartment	210
⑩	Automatic transmission selector lever	112	⑭	Stowage compartment with Media Interface	210
⑪	Selects park position	112	⑮	Cigarette lighter	217
⑫	 Activates/deactivates the off-road gear ratio	149	⑯	Controller	204
⑬	Stowage compartment	210	⑰	 Switches the wind- shield heating on/off	101
⑭	Stowage compartment with Media Interface	210	⑱	 Adjustable damping	111
⑮	Cigarette lighter	217	⑲	 Selects the drive pro- gram Mercedes-AMG vehicles:  Selects the drive pro- gram	115
⑯	Controller	204	⑳	Parking brake	123
⑰	 Switches the wind- shield heating on/off	101			
⑱	 Adjustable damping	111			
⑲	 Selects the drive pro- gram Mercedes-AMG vehicles:  Selects the drive pro- gram	115			
⑳	Parking brake	123			



## Overhead control panel

At a glance



P82.00-3194-31

	Function	Page
①	 Switches the left-hand reading lamp on/off	89
②	 Switches the front interior lighting on	89
③	 Switches the rear interior lighting on/off	89
④	 Switches the front interior lighting/automatic interior lighting control off	89
⑤	 Switches the right-hand reading lamp on/off	89
⑥	 Opens/closes the sliding sunroof	72
⑦	 Info call button (mbrace system)	222

	Function	Page
⑧	Rear-view mirror	81
⑨	Buttons for the garage door opener	229
⑩	 Breakdown assistance call button (mbrace system)	221
⑪	 SOS button (mbrace system)	220
⑫	Microphone for mbrace system (emergency call system), telephone and the Voice Control System, see the separate operating instructions	

Door control panel

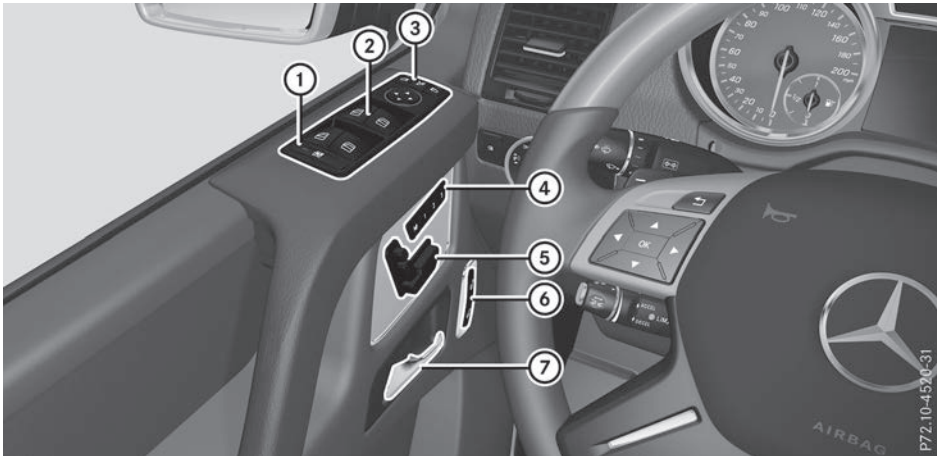

At a glance

	Function	Page
①	Override feature for the rear side windows	57
②	Opens/closes the side windows	69
③	Adjusts and folds the exterior mirrors in/out electrically	82
④	<b>M</b> <b>1</b> <b>2</b> <b>3</b> Stores settings for the seat, exterior mirrors and steering column	84

	Function	Page
⑤	Adjusts the seats electrically	76
⑥	Locks/unlocks the vehicle	67
⑦	Opens the door	67

### Panic alarm



- ▶ **To arm:** press and hold the **PANIC** button ① for approximately one second. A visual and audible alarm is triggered if the alarm system is armed.
  - ▶ **To deactivate:** press the **PANIC** button ① again.
- or
- ▶ Insert the SmartKey into the ignition lock.

### Occupant safety

#### Introduction to the restraint system

The restraint system can reduce the risk of vehicle occupants coming into contact with parts of the vehicle's interior in the event of an accident. The restraint system can also reduce the forces to which vehicle occupants are subjected during an accident.

The restraint system comprises:

- Seat belt system
- Air bags
- Child restraint system
- Child seat securing systems

The components of the restraint system work in conjunction with each other. They can only deploy their protective function if, at all times, all vehicle occupants:

- have fastened their seat belts correctly (▷ page 41)
- have the seat and head restraint adjusted properly (▷ page 74)

As the driver, you also have to make sure that the steering wheel is adjusted correctly. Observe the information relating to the correct driver's seat position (▷ page 74).

You also have to make sure that an air bag can inflate properly if deployed (▷ page 44).

An air bag supplements a correctly worn seat belt. As an additional safety device, the air bag increases the level of protection for vehicle occupants in the event of an accident. For example, if, in the event of an accident, the protection offered by the seat belt is sufficient, the air bags are not deployed. When an accident occurs, only the air bags that increase protection in that particular accident situation are deployed. However, seat belts and air bags generally do not protect against objects penetrating the vehicle from the outside.

Information on restraint system operation can be found under "Triggering of the Emergency Tensioning Devices and air bags" (▷ page 47). See "Children in the vehicle" for information on children traveling with you in the vehicle as well as on child restraint systems (▷ page 50).

#### Important safety notes

##### WARNING

Modifications to the restraint system may cause it to no longer work as intended. The restraint system may then not perform its intended protective function and may fail in an accident or trigger unexpectedly, for example. This poses an increased risk of injury or even fatal injury.

Never modify parts of the restraint system. Never tamper with the wiring, the electronic components or their software.

If it is necessary to modify components of the restraint system to accommodate a person with disabilities, contact an authorized Mercedes-Benz Center for details. USA only: for further information contact our Customer Assistance Center at 1-800-FOR-MERCEDES (1-800-367-6372).

Mercedes-Benz recommends that you only use driving aids which have been approved specifically for your vehicle by Mercedes-Benz.

#### Restraint system warning lamp

The functions of the restraint system are checked after the ignition is switched on and at



regular intervals while the engine is running. Therefore, malfunctions can be detected in good time.

The  restraint system warning lamp on the instrument cluster lights up when the ignition is switched on. It goes out no later than a few seconds after the vehicle is started. The components of the restraint system are in operational readiness.

A malfunction has occurred if the  restraint system warning lamp:

- does not light up after the ignition is switched on
- does not go out after a few seconds with the engine running
- lights up again while the engine is running

### WARNING

If the restraint system is malfunctioning, restraint system components may be triggered unintentionally or may not deploy as intended during an accident. This can affect for example the Emergency Tensioning Device or the air bag. This poses an increased risk of injury or even fatal injury.

Have the restraint system checked and repaired in a qualified specialist workshop as soon as possible.

## PASSENGER AIR BAG OFF indicator lamp



PASSENGER AIR BAG OFF indicator lamp  is part of the BabySmart™ air bag deactivation system.

A permanently lit PASSENGER AIR BAG OFF indicator lamp informs you that the front-passenger front air bag is deactivated.

Depending on the person in the front-passenger seat, the front-passenger front air bag must either be deactivated or enabled; see the following points. You must make sure of this both before and during a journey.

- **Children in a child restraint system:** whether the front-passenger front air bag is enabled or deactivated depends on the installed child restraint system, and the age and size of the child. Therefore, always observe the information on "Children in the vehicle" (> page 50). There you will also find instructions on rearward and forward-facing child restraint systems on the front-passenger seat.
- **All other persons:** the PASSENGER AIR BAG OFF indicator lamp must be off. Be sure to observe the notes on "Seat belts" (> page 39) and "Air bags" (> page 44). There you can also find information on the correct seat position.

Observe the information on the BabySmart™ air bag deactivation system in the front-passenger seat (> page 53).

## Seat belts

### Introduction

Seat belts are the most effective means of restricting the movement of vehicle occupants in the event of an accident or the vehicle rolling over. This reduces the risk of vehicle occupants coming into contact with parts of the vehicle interior or being ejected from the vehicle. Furthermore, the seat belt helps to keep the vehicle occupant in the best position in relation to the air bag.

The seat belt system comprises:

- Seat belts
- Emergency Tensioning Devices for the front seat belts and the outer seat belts in the rear
- Seat belt force limiters for the front seat belts and the outer seat belts in the rear

If the seat belt is pulled out at the belt sash guide quickly or with a jerky movement, the belt retractor locks. The belt strap cannot be extracted any further.

The Emergency Tensioning Device tightens the seat belt in an accident, pulling the belt close against the body. However it does not pull the

vehicle occupant back in the direction of the backrest.

The Emergency Tensioning Device does not correct an incorrect seat position or the routing of an incorrectly fastened seat belt.

When triggered, a seat belt force limiter helps to reduce the force exerted by the seat belt on the vehicle occupant.

The seat belt force limiters for the front seats are synchronized with the front air bags, which absorb part of the deceleration force. This can reduce the force exerted on the vehicle occupants during an accident.

**!** If the front-passenger seat is not occupied, do not engage the seat belt tongue in the buckle on the front-passenger seat. Otherwise, in addition to other systems, the Emergency Tensioning Device could also be triggered in the event of an accident and would need to be replaced.

### Important safety notes

The use of seat belts and child restraint systems is required by law in:

- all 50 states
- the U.S. territories
- the District of Columbia
- all Canadian provinces

Even where this is not required by law, all vehicle occupants should correctly fasten their seat belts before starting the journey.

#### WARNING

If the seat belt is not worn correctly, it cannot perform its intended protective function. An incorrectly fastened seat belt can also cause injuries, for example, in the event of an accident or when braking or changing direction abruptly. This poses an increased risk of injury or even fatal injury.

Always ensure that all vehicle occupants have their seat belts fastened correctly and are sitting properly.

The components of the restraint system work in conjunction with each other. They can only deploy their protective function if, at all times, all vehicle occupants:

- have fastened their seat belts correctly (▷ page 41)
- have the seat and head restraint adjusted properly (▷ page 74)

#### WARNING

The seat belt does not offer the intended level of protection if you have not moved the backrest to an almost vertical position. When braking or in the event of an accident, you could slide underneath the seat belt and sustain abdomen or neck injuries, for example. This poses an increased risk of injury or even fatal injury.

Adjust the seat properly before beginning your journey. Always ensure that the backrest is in an almost vertical position and that the shoulder section of your seat belt is routed across the center of your shoulder.

#### WARNING

Persons less than 5 ft (1.50 m) tall cannot wear the seat belt correctly without an additional and suitable restraint system. If the seat belt is not worn correctly, it cannot perform its intended protective function. An incorrectly fastened seat belt can also cause injuries, for example, in the event of an accident or when braking or changing direction abruptly. This poses an increased risk of injury or even fatal injury.

For this reason, always secure persons under 5 ft (1.50 m) tall in suitable additional restraint systems.

If a child younger than twelve years old and under 5 ft (1.50 m) in height is traveling in the vehicle:

- always secure the child in a child restraint system suitable for this Mercedes-Benz vehicle. The child restraint system must be appropriate to the age, weight and size of the child
- always observe the instructions and safety notes on "Children in the vehicle" (▷ page 50) in addition to the child restraint

system manufacturer's installation and operating instructions

### **WARNING**

The seat belts may not perform their intended protective function if:

- they are damaged, modified, extremely dirty, bleached or dyed
- the seat belt buckle is damaged or extremely dirty
- the Emergency Tensioning Devices, belt anchorages or inertia reels have been modified.

Seat belts may be damaged in an accident, although the damage may not be visible, e.g. due to splinters of glass. Modified or damaged seat belts may tear or fail, e.g. in an accident. Modified Emergency Tensioning Devices could accidentally trigger or fail to deploy when necessary. This poses an increased risk of injury or even fatal injury.

Never modify the seat belts, Emergency Tensioning Devices, belt anchorages and inertia reels. Make sure that the seat belts are undamaged, not worn out and clean. Following an accident, have the seat belts checked immediately at a qualified specialist workshop.

Only use seat belts that have been approved for your vehicle by Mercedes-Benz.

### **Proper use of the seat belts**

Observe the safety notes on the seat belt (> page 40).

All vehicle occupants must be wearing the seat belt correctly before beginning the journey. Also make sure that all vehicle occupants are always wearing the seat belt correctly while the vehicle is in motion.

When fastening the seat belt, always make sure that:

- the seat belt buckle tongue is inserted only into the belt buckle belonging to that seat
- the seat belt is pulled tight across your body  
Avoid wearing bulky clothing, e.g. a winter coat.
- the seat belt is not twisted

Only then can the forces which occur be distributed over the area of the belt.

- the shoulder section of the belt is routed across the center of your shoulder

The shoulder section of the seat belt should not touch your neck or be routed under your arm or behind your back. Where possible, adjust the seat belt to the appropriate height.

- the lap belt is taut and passes across your lap as low down as possible

The lap belt must always be routed across your hip joints and not across your abdomen. This applies particularly to pregnant women. If necessary, push the lap belt down to your hip joint and pull it tight using the shoulder section of the belt.

- the seat belt is not routed across sharp, pointed or fragile objects

If you have such items located on or in your clothing, e.g. pens, keys or eyeglasses, store these in a suitable place.

- only one person is using a seat belt  
Infants and children must never travel sitting on the lap of a vehicle occupant. In the event of an accident, they could be crushed between the vehicle occupant and seat belt.
- objects are never secured with a seat belt if the seat belt is also being used by one of the vehicle's occupants

Also ensure that there are never objects between a person and the seat, e.g. cushions.

Seat belts are only intended to secure and restrain vehicle occupants. Always observe the "Loading guidelines" for securing objects, luggage or loads (> page 209).

### **Fastening and adjusting the seat belts**

Observe the safety notes on the seat belt (> page 40) and the notes on correct use of seat belts (> page 41).

If the center rear seat belt is being used, also observe the information about the seat belt for the center rear seat (> page 42).

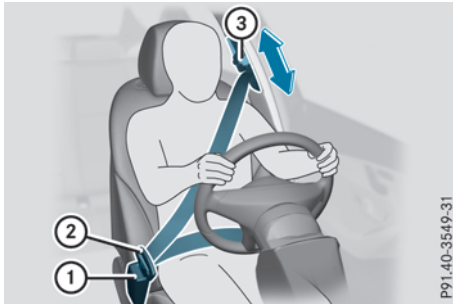

P91\_40-3549-31

Basic illustration

- ▶ Adjust the seat (▷ page 74). The seat backrest must be in an almost upright position.
- ▶ Pull the seat belt smoothly out of belt sash guide ③ and engage belt tongue ② into belt buckle ①.
- ▶ If necessary, pull up on the shoulder section of the seat belt to tighten the belt across your body.

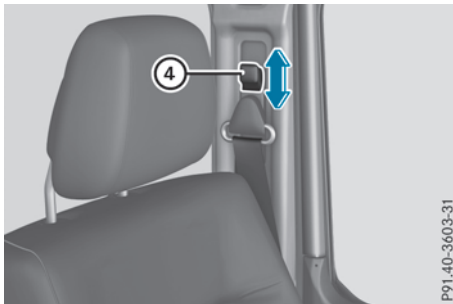

P91\_40-3603-31

The shoulder section of the seat belt must always be routed across the center of the shoulder. Adjust the belt sash guide if necessary.

- ▶ **To raise:** slide the belt sash guide up. The belt sash guide engages in various positions.
- ▶ **To lower:** pull release button ④ and slide the belt sash guide down.
- ▶ Let go of release button ④ in the desired position and make sure that the belt sash guide engages.

All seat belts except the driver's seat belt are equipped with a special seat belt retractor to securely fasten child restraint systems in the vehicle. Further information can be found under "Special seat belt retractor" (▷ page 50).

### Seat belt for the center rear seat

#### ⚠ WARNING

When the three-point seat belt for the center rear seat is not in use, it may be thrown around while driving, e.g. when braking or in an accident. There is a risk of injury.

When the three-point seat belt for the center rear seat is not in use, always secure both belt buckle tongues in the retainer.

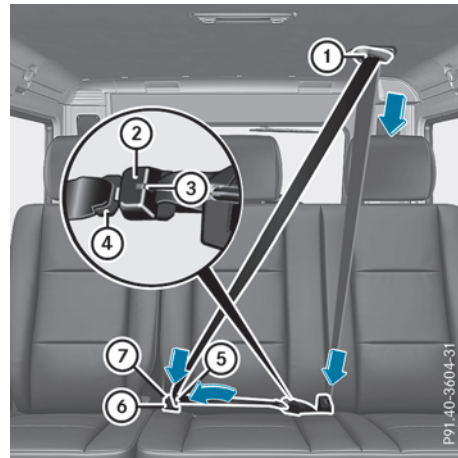

P91\_40-3604-31

- ① Bracket for seat belt tongues
- ② Belt buckle for fixed belt tongue
- ③ Release button for fixed belt tongue
- ④ Fixed belt tongue
- ⑤ Belt buckle for movable belt tongue
- ⑥ Release button for movable belt tongue
- ⑦ Movable belt tongue

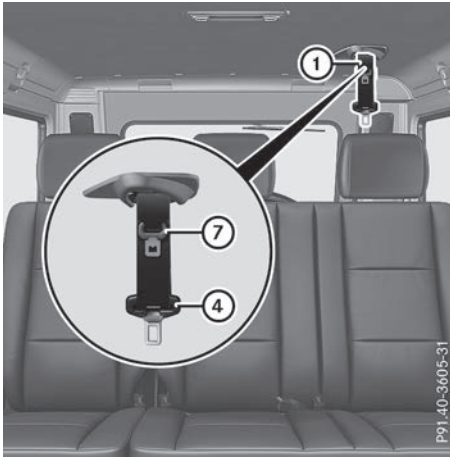

- Pull both seat belt tongues ④ and ⑦ from bracket ①.

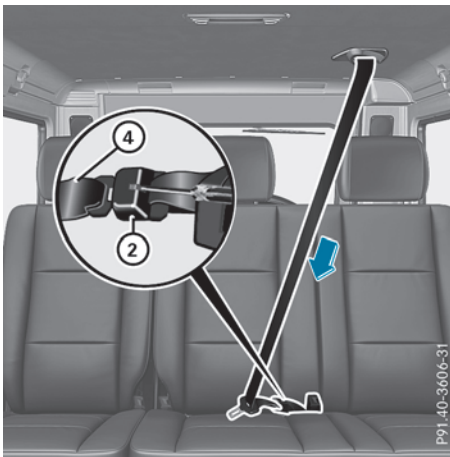

- Pull the seat belt smoothly from the belt outlet and engage fixed belt tongue ④ in belt buckle ②.





- **To fasten the seat belt:** pull the seat belt smoothly from the belt outlet and engage movable belt tongue ⑦ in belt buckle ⑤.
- If necessary, pull up on the shoulder section of the seat belt to tighten the belt across your body.

### Releasing seat belts

- ❗ Make sure that the seat belt is fully rolled up. Otherwise, the seat belt or belt tongue will be trapped in the door or in the seat mechanism. This could damage the door, the door trim panel and the seat belt. Damaged seat belts can no longer fulfill their protective function and must be replaced. Visit a qualified specialist workshop.
- Press the release button in the belt buckle, hold the belt tongue firmly and guide the belt back.

### Belt warning for the driver and front passenger

The  seat belt warning lamp in the instrument cluster is a reminder that all vehicle occupants must wear their seat belts. It may light up continuously or flash. In addition, there may be a warning tone.

Regardless of whether the driver's seat belt has already been fastened, the  seat belt warning lamp lights up for six seconds each time the engine is started. If the front doors are closed and the driver's or front-passenger seat belt has not been fastened, the  seat belt warning

lamp lights up again after the six seconds. As soon as the driver's and front-passenger seat belts are fastened or a front door is opened again, the  seat belt warning lamp goes out. If the driver's seat belt is not fastened after the engine is started, an additional warning tone will sound. The warning tone switches off after six seconds or once the driver's seat belt is fastened.

If the vehicle's speed exceeds 15 mph (25 km/h) once and the driver's and front-passenger seat belts are not fastened, a warning tone sounds. A warning tone also sounds with increasing intensity for 60 seconds or until the driver or front passenger have fastened their seat belts.

If the driver or front passenger unfasten their seat belts during the journey, the seat belt warning is activated again.

### Air bags

#### Introduction

The installation point of an air bag can be recognized by the AIRBAG marking.

An air bag complements the correctly fastened seat belt. It is no substitute for the seat belt. The air bag provides additional protection in applicable accident situations.

Not all air bags are deployed in an accident. The different air bag systems function independently from one another (▷ page 47).

However, no system available today can completely eliminate injuries and fatalities.

It is also not possible to rule out a risk of injury caused by an air bag due to the high speed at which the air bag must be deployed.

#### Important safety notes

##### WARNING

If you do not sit in the correct seat position, the air bag cannot protect as intended and could even cause additional injury when deployed. This poses an increased risk of injury or even fatal injury.

To avoid hazardous situations, always make sure that all of the vehicle's occupants:

- have fastened their seat belts correctly, including pregnant women
- are sitting correctly and maintain the greatest possible distance to the air bags
- follow the following instructions

Always make sure that there are no objects between the air bag and the vehicle's occupants.

- Adjust the seats properly before beginning your journey. Always make sure that the seat is in an almost upright position. The center of the head restraint must support the head at about eye level.
- Move the driver's and front-passenger seats as far back as possible. The driver's seat position must allow the vehicle to be driven safely.
- Only hold the steering wheel on the outside. This allows the air bag to be fully deployed.
- Always lean against the backrest while driving. Do not lean forward or lean against the door or side window. You may otherwise be in the deployment area of the air bags.
- Always keep your feet in the footwell in front of the seat. Do not put your feet on the dashboard, for example. Your feet may otherwise be in the deployment area of the air bag.
- For this reason, always secure persons less than 5 ft (1.50 m) tall in suitable restraint systems. Up to this height, the seat belt cannot be worn correctly.

#### If a child is traveling in your vehicle, also observe the following notes:

- Always secure children under twelve years of age and less than 5 ft (1.50 m) tall in suitable child restraint systems.
- Child restraint systems should be installed on the rear seats.
- Only secure a child in a rearward-facing child restraint system on the front-passenger seat when the front-passenger front air bag is deactivated. If the PASSENGER AIR BAG OFF indicator lamp is permanently lit, the front-passenger front air bag is deactivated (▷ page 39).
- Always observe the instructions and safety notes on "Children in the vehicle" (▷ page 50) and on the "Child restraint sys-

tem on the front-passenger seat"

(▷ page 55) in addition to the child restraint system manufacturer's installation and operating instructions.

**Objects in the vehicle interior may prevent an air bag from functioning correctly.** Before starting your journey and to avoid risks resulting from the speed of the air bag as it deploys, make sure that:

- there are no people, animals or objects between the vehicle occupants and an air bag
- there are no objects between the seat, door and B-pillar
- there are no hard objects, e.g. coat hangers, hanging on the grab handles or coat hooks
- no accessories, such as cup holders, are attached to the vehicle within the deployment area of an air bag, e.g. to doors, side windows, rear side trim or side walls
- no heavy, sharp-edged or fragile objects are in the pockets of your clothing. Store such objects in a suitable place

#### **WARNING**

If you modify the air bag cover or affix objects such as stickers to it, the air bag can no longer function correctly. There is an increased risk of injury.

Never modify an air bag cover or affix objects to it.

#### **WARNING**

Sensors to control the air bags are located in the doors. Modifications or work not performed correctly to the doors or door paneling, as well as damaged doors, can lead to the function of the sensors being impaired. The air bags might therefore not function properly anymore. Consequently, the air bags cannot protect vehicle occupants as they are designed to do. There is an increased risk of injury.

Never modify the doors or parts of the doors. Always have work on the doors or door paneling carried out at a qualified specialist workshop.

## Front air bags

- ❗ Do not place heavy objects on the front-passenger seat. This could cause the system to identify the seat as being occupied. In the event of an accident, the restraint systems on the front-passenger side may be triggered and have to be replaced.

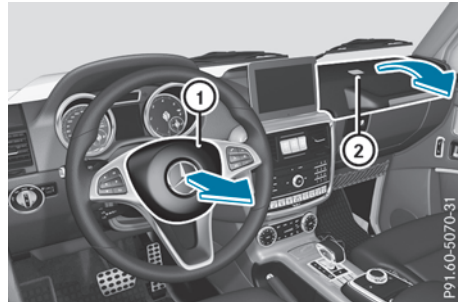

Driver's air bag ① deploys in front of the steering wheel. Front-passenger front air bag ② deploys in front of and above the glove box.

When deployed, the front air bags offer additional head and thorax protection for the occupants in the front seats.

A permanently lit PASSENGER AIR BAG OFF indicator lamp informs you that the front-passenger front air bag is deactivated (▷ page 39).

The front-passenger front air bag will only deploy if:

- an occupant is detected on the front-passenger seat
- the PASSENGER AIR BAG OFF indicator lamp does not light up (▷ page 53)
- the restraint system control unit predicts a high accident severity

## Side impact air bags

#### **WARNING**

Unsuitable seat covers can obstruct or prevent deployment of the air bags integrated into the seats. Consequently, the air bags cannot protect vehicle occupants as they are designed to do. In addition, the functions of BabySmart™ may be impaired. This poses an increased risk of injury or even fatal injury.

You should only use seat covers that have been approved for the respective seat by Mercedes-Benz.

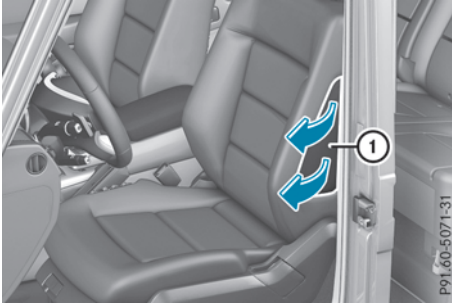

Side impact air bags ① deploy next to the outer bolster of the seat backrest.

When deployed, the side impact air bag offers additional thorax protection. However, it does not protect the:

- Head
- Neck
- Arms

If the restraint system control unit detects a side impact, the side impact air bag is deployed on the side on which the impact occurs.

### Pelvis air bags

#### WARNING

Unsuitable seat covers can obstruct or prevent deployment of the air bags integrated into the seats. Consequently, the air bags cannot protect vehicle occupants as they are designed to do. In addition, the functions of BabySmart™ may be impaired. This poses an increased risk of injury or even fatal injury.

You should only use seat covers that have been approved for the respective seat by Mercedes-Benz.

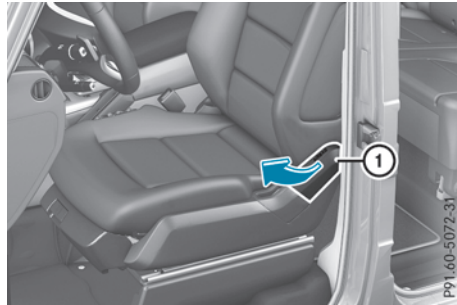

Pelvis air bags ① deploy below next to the outer seat cushions.

When activated, the pelvis air bag increases the level of protection for vehicle occupants on the side of the vehicle on which the impact occurs.

When the restraint system control unit detects a side impact, the pelvis air bag is deployed on the side on which the impact occurs.

### Window curtain air bags

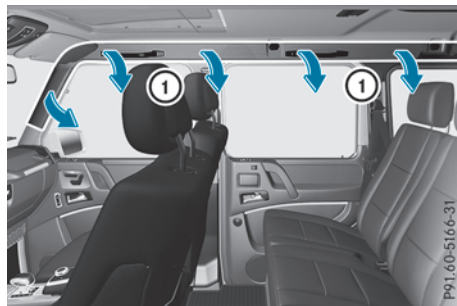

Window curtain air bags ① are integrated into the side of the roof frame and deployed in the area from the A-pillar to the C-pillar.

When deployed, the window curtain air bag enhances the level of protection for the head. However, it does not protect the chest or arms.

If the restraint system control unit detects a side impact, the window curtain air bag is deployed on the side on which the impact occurs.

If the system determines that they can offer additional protection to that provided by the seat belt, a window curtain air bag may be deployed in other accident situations (> page 47).



## Deployment of Emergency Tensioning Devices and air bags

### Important safety notes

#### WARNING

The air bag parts are hot after an air bag has been deployed. There is a risk of injury.

Do not touch the air bag parts. Have a deployed air bag replaced at a qualified specialist workshop as soon as possible.

#### WARNING

A deployed air bag no longer offers any protection and cannot provide the intended protection in an accident. There is an increased risk of injury.

Have the vehicle towed to a qualified specialist workshop in order to have a deployed air bag replaced.

It is important for your safety and that of your passenger to have deployed air bags replaced and to have any malfunctioning air bags repaired. This will help to make sure the air bags continue to perform their protective function for the vehicle occupants in the event of a crash.

#### WARNING

Emergency Tensioning Devices that have deployed pyrotechnically are no longer operational and are unable to perform their intended protective function. This poses an increased risk of injury or even fatal injury.

Have pyrotechnically triggered Emergency Tensioning Devices replaced immediately at a qualified specialist workshop.

If Emergency Tensioning Devices are triggered or air bags are deployed, you will hear a bang, and some powder may also be released. The  restraint system warning lamp lights up.

Only in rare cases will the bang affect your hearing. The powder that is released generally does not constitute a health hazard, but it may cause short-term breathing difficulties in people with asthma or other respiratory problems. Provided it is safe to do so, you should leave the vehicle immediately or open the window in order to prevent breathing difficulties.

Air bags and pyrotechnic Emergency Tensioning Devices (ETDs) contain perchlorate material, which may require special handling and regard for the environment. National guidelines must be observed during disposal. In California, see [www.dtsc.ca.gov/HazardousWaste/Perchlorate/index.cfm](http://www.dtsc.ca.gov/HazardousWaste/Perchlorate/index.cfm).

### Method of operation

During the first stage of a collision, the restraint system control unit evaluates important physical data relating to vehicle deceleration or acceleration, such as:

- duration
- direction
- intensity

Based on the evaluation of this data, the restraint system control unit triggers the Emergency Tensioning Devices during a frontal or rear collision.

An Emergency Tensioning Device can only be triggered, if:

- the ignition is switched on
- the components of the restraint system are operational. You can find further information under "Restraint system warning lamp" ([▷ page 38](#))
- the seat belt buckle tongue has engaged in the belt buckle of the respective front seat

The Emergency Tensioning Devices in the rear compartment are triggered independently of the lock status of the seat belts.

If the restraint system control unit detects a more severe accident, further components of the restraint system are activated independently of each other in certain frontal collision situations:

- Driver's air bag
- Front-passenger front air bag

The front-passenger front air bag is activated or deactivated depending on the person on the front-passenger seat. The front-passenger front air bag can only deploy in an accident if the PASSENGER AIR BAG OFF indicator lamp is off. Observe the information on the PASSENGER AIR BAG OFF indicator lamp ([▷ page 39](#)).

Your vehicle has a two-stage driver's air bag. In the first deployment stage, the front air bag is filled with propellant gas. The front air bag is fully deployed with the maximum amount of propel-

lant gas if a second deployment threshold is reached within a few milliseconds.

The activation threshold of the Emergency Tensioning Devices and the air bags is determined by evaluating the rate of vehicle deceleration or acceleration which occurs at various points in the vehicle. This process is pre-emptive in nature. Deployment should take place in good time at the start of the collision.

The rate of vehicle deceleration or acceleration and the direction of the force are essentially determined by:

- the distribution of forces during the collision
- the collision angle
- the deformation characteristics of the vehicle
- the characteristics of the object with which the vehicle has collided

Factors which can only be seen and measured after a collision has occurred do not play a decisive role in the deployment of an air bag. Nor do they provide an indication of air bag deployment.

The vehicle can be deformed considerably, without an air bag being deployed. This is the case if only parts which are relatively easily deformed are affected and the rate of deceleration is not high. Conversely, air bags may be deployed even though the vehicle suffers only minor deformation. This is the case if, for example, very rigid vehicle parts such as longitudinal body members are hit, and sufficient deceleration occurs as a result.

If the restraint system control unit detects a side impact or if the vehicle rolls over, the applicable components of the restraint system are deployed independently of each other depending on the apparent type of accident.

- Side impact air bag and pelvis air bag on the side on which an impact occurs, independent from the Emergency Tensioning Device and seat belt usage

The side impact air bag on the front-passenger side deploys under the following conditions:

- BabySmart™ detects that the front-passenger seat is occupied or
- the seat belt buckle tongue is engaged in the belt buckle of the front-passenger seat
- Window curtain air bag on the side of impact, independently of the use of the seat belt and independently of whether the front-passenger seat is occupied

- Emergency Tensioning Devices, if the system determines that deployment can offer additional protection in this situation
- Window curtain air bags on the driver's and front-passenger side in certain situations when the vehicle rolls over, if the system determines that deployment can offer additional protection to that provided by the seat belt

**i** Not all air bags are deployed in an accident. The different air bag systems work independently of each other.

How the air bag system works is determined by the severity of the accident detected, especially the vehicle deceleration or acceleration and the apparent type of accident:

- Frontal collision
- Side impact
- Rollover

### NECK-PRO head restraints/NECK-PRO luxury head restraints

#### Important safety notes

##### WARNING

The function of the head restraint may be impaired if you:

- attach objects such as coat hangers to the head restraints, for example
- use head restraint covers

If you do so, the head restraints cannot fulfill their intended protective function in the event of an accident. In addition, objects attached to the head restraints could endanger other vehicle occupants. There is an increased risk of injury.

Do not attach any objects to the head restraints and do not use head restraint covers.

#### Method of operation

NECK-PRO head restraints/NECK-PRO luxury head restraints offer additional protection against head and neck injuries. In the event of a rear collision of a certain severity, the NECK-PRO head restraints/NECK-PRO luxury head

restraints on the driver's and front-passenger seats are moved forwards and upwards. This provides better head support.

If the NECK-PRO head restraints/NECK-PRO luxury head restraints have been triggered in an accident, reset the NECK-PRO head restraints/NECK-PRO luxury head restraints on the driver's seat and the front-passenger seat (▷ page 49). Otherwise, the additional protection will not be available in the event of another rear-end collision. You can see that a NECK-PRO head restraint/NECK-PRO luxury head restraint has been triggered if it is tilted forward and can no longer be adjusted.

Mercedes-Benz recommends that you have the functionality of the NECK-PRO head restraints/NECK-PRO luxury head restraints checked at a qualified specialist workshop after a rear-end collision.

### Resetting a triggered NECK-PRO head restraint/NECK-PRO luxury head restraint

#### NECK-PRO head restraints



Do not insert your finger between the cushion of the head restraint and the cover. Pay particular attention while resetting the NECK-PRO head restraints.

- ▶ Tilt the top of the NECK-PRO head restraint cushion forward in the direction of arrow ①.
- ▶ Push the NECK-PRO head restraint cushion down as far as it will go in the direction of arrow ②.
- ▶ With your hand flat, firmly push the NECK-PRO head restraint cushion back in the direction of arrow ③ until it engages.
- ▶ Repeat this procedure for the second NECK-PRO head restraint.

- ⓘ Resetting the NECK-PRO head restraints requires a lot of strength. If you have difficulty resetting the NECK-PRO head restraints, have this work carried out at a qualified specialist workshop.

#### NECK-PRO luxury head restraints

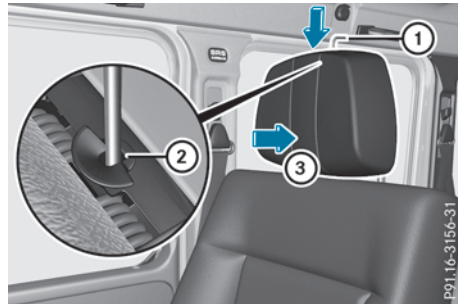

Do not insert your finger between the cushion of the head restraint and the cover. Pay particular attention while resetting the NECK-PRO luxury head restraints.

- ▶ Remove resetting tool ① from the vehicle document wallet.
- ▶ Slide resetting tool ① into guide ② between the NECK-PRO luxury head restraint and the rear cover of the head restraint.
- ▶ Push resetting tool ① down until you hear the head restraint deployment mechanism engage.
- ▶ Pull out resetting tool ①.
- ▶ With your hand flat, firmly push the NECK-PRO luxury head restraint cushion back in the direction of arrow ③ until it engages.
- ▶ Repeat this procedure for the second NECK-PRO luxury head restraint.
- ▶ Put resetting tool ① back into the vehicle document wallet.

- ⓘ If you have difficulty resetting the NECK-PRO luxury head restraints, have this work carried out at a qualified specialist workshop.

### Automatic measures after an accident

Immediately after an accident, the following measures are implemented, depending on the type and severity of the impact:

- the hazard warning lamps are activated
- the emergency lighting is activated
- the vehicle doors are unlocked
- the front side windows are lowered
- the electrically adjustable steering wheel is raised when the driver's door is opened
- the engine is switched off and the fuel supply is cut off
- vehicles with mbrace: automatic emergency call

### Children in the vehicle

#### Important safety notes

Accident statistics show that children secured in the rear seats are safer than children secured in the front-passenger seat. For this reason, Mercedes-Benz strongly advises that you install a child restraint system on a rear seat. Children are generally better protected there.

If a child younger than twelve years old and under 5 ft (1.50 m) in height is traveling in the vehicle:

- always secure the child in a child restraint system suitable for Mercedes-Benz vehicles. The child restraint system must be appropriate to the age, weight and size of the child
- be sure to observe the instructions and safety notes in this section in addition to the child restraint system manufacturer's installation instructions

#### WARNING

If you leave children unsupervised in the vehicle, they could set it in motion by, for example:

- release the parking brake.
- shift the automatic transmission out of the parking position **P**.
- start the engine.

In addition, they may operate vehicle equipment and become trapped. There is a risk of an accident and injury.

When leaving the vehicle, always take the SmartKey with you and lock the vehicle. Never leave children unsupervised in the vehicle.

#### WARNING

If persons, particularly children are subjected to prolonged exposure to extreme heat or cold, there is a risk of injury, possibly even fatal. Never leave children unattended in the vehicle.

#### WARNING

If the child restraint system is subjected to direct sunlight, parts may get very hot. Children may burn themselves on these parts, particularly on the metal parts of the child restraint system. There is a risk of injury.

If you leave the vehicle, taking the child with you, always ensure that the child restraint system is not exposed to direct sunlight. Protect it with a blanket, for example. If the child restraint system has been exposed to direct sunlight, let it cool down before securing the child in it. Never leave children unattended in the vehicle.

Always ensure that all vehicle occupants have their seat belts fastened correctly and are sitting properly. Particular attention must be paid to children.

Observe the safety notes on the seat belt (> page 40) and the notes on correct use of seat belts (> page 41).

A booster seat may be necessary to achieve proper seat belt positioning for children over 41 lbs (18 kg) until they reach a height where a three-point seat belt can be properly fastened without a booster seat.

### Special seatbelt retractor

#### WARNING

If the seat belt is released while driving, the child restraint system will no longer be secured properly. The special seat belt retractor is disabled and the inertia reel draws in a portion of the seat belt. The seat belt cannot

be immediately refastened. There is an increased risk of injury, possibly even fatal. Stop the vehicle immediately, paying attention to road and traffic conditions. Reactivate the special seat belt retractor and secure the child restraint system properly.

All seat belts in the vehicle, except the driver's seat belt, are equipped with a special seat belt retractor. When activated, the special seat belt retractor ensures that the seat belt cannot slacken once the child seat is secured.

Installing a child restraint system:

- ▶ Make sure you observe the child restraint system manufacturer's installation instructions.
- ▶ Pull the seat belt smoothly out of the belt sash guide.
- ▶ Engage seat belt tongue in belt buckle.

Activating the special seat belt retractor:

- ▶ Pull the seat belt out fully and let the inertia reel retract it again. While the seat belt is retracting, you should hear a ratcheting sound. The special seat belt retractor is enabled.
- ▶ Push the child restraint system down so that the seat belt is tight and does not loosen.

Removing the child restraint system and deactivating the special seat belt retractor:

- ▶ Make sure you observe the child restraint system manufacturer's installation instructions.
- ▶ Press the release button of the seat belt buckle and route the seat belt tongue back towards the belt sash guide. The special seat belt retractor is deactivated.

### Child restraint system

The use of seat belts and child restraint systems is required by law in:

- all 50 states
- the U.S. territories
- the District of Columbia
- all Canadian provinces

You can obtain further information about the correct child restraint system from any authorized Mercedes-Benz Center.

### WARNING

If the child restraint system is installed incorrectly on a suitable seat, it cannot protect as intended. The child cannot then be restrained in the event of an accident, heavy braking or sudden changes of direction. There is an increased risk of injury, possibly even fatal.

Make sure that you observe the child restraint system manufacturer's installation instructions and the notes on use. Please ensure, that the base of the child restraint system is always resting completely on the seat cushion. Never place objects, e.g. cushions, under or behind the child restraint system. Only use child restraint systems with the original cover designed for them. Only replace damaged covers with genuine covers.

### WARNING

If the child restraint system is installed incorrectly or is not secured, it can come loose in the event of an accident, heavy braking or a sudden change in direction. The child restraint system could be thrown about, striking vehicle occupants. There is an increased risk of injury, possibly even fatal.

Always install child restraint systems properly, even if they are not being used. Make sure that you observe the child restraint system manufacturer's installation instructions.

You will find further information on stowing objects, luggage or loads under "Loading guidelines" (▷ page 209).

### WARNING

Child restraint systems or their securing systems which have been damaged or subjected to a load in an accident can no longer protect as intended. The child cannot then be restrained in the event of an accident, heavy braking or sudden changes of direction. There is an increased risk of injury, possibly even fatal.

Replace child restraint systems which have been damaged or subjected to a load in an accident as soon as possible. Have the secur-

ing systems on the child restraint system checked at a qualified specialist workshop, before you install a child restraint system again.

The securing systems of child restraint systems are:

- the seat belt system
- the LATCH-type (ISOFIX) securing rings
- the Top Tether anchorages

**i** If it is absolutely necessary to install a child restraint system on the front-passenger seat, always observe the information on "Child restraint systems on the front-passenger seat" (▷ page 55). There you will also find information on deactivating the front-passenger front air bag.

All child restraint systems must meet the following standards:

- U.S. Federal Motor Vehicle Safety Standards 213 and 225
- Canadian Motor Vehicle Safety Standards 213 and 210.2

Confirmation that the child restraint system corresponds to the standards can be found on an instruction label on the child restraint system. This confirmation can also be found in the installation instructions that are included with the child restraint system.

Observe the warning labels in the vehicle interior and on the child restraint system.

### LATCH-type (ISOFIX) child seat securing system

#### **⚠ WARNING**

LATCH-type (ISOFIX) child restraint systems do not offer sufficient protection for children whose weight combined with the child restraint system is greater than 65 lbs (29 kg) and who are secured using the safety belt integrated in the child restraint system. In the event of an accident, a child might not be restrained correctly. This poses an increased risk of injury or even fatal injury.

If the child and the child restraint system together weigh more than 65 lbs (29 kg), only use LATCH-type (ISOFIX) child restraint sys-

tems with which the child is also secured with the vehicle seat belt. Also secure the child restraint system with the Top Tether belt, if available.

Always comply with the manufacturer's installation and operating instructions for the child restraint system used.

Before every trip, make sure that the LATCH-type (ISOFIX) child restraint system is engaged correctly in both LATCH-type (ISOFIX) securing rings

**!** When installing the child restraint system, make sure that the seat belt for the middle seat does not get trapped. The seat belt could otherwise be damaged.

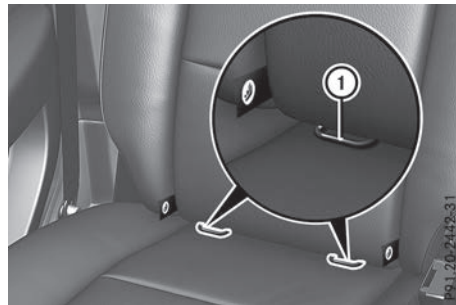

► Install the LATCH-type (ISOFIX) child restraint system on both LATCH-type (ISOFIX) securing rings ①.

ISOFIX is a standardized securing system for specially designed child restraint systems on the rear seats. LATCH-type (ISOFIX) securing rings for two LATCH-type (ISOFIX) child restraint systems are installed on the left and right of the rear seats.

Non-LATCH-type (ISOFIX) child seats may also be used and can be installed using the vehicle's seat belt system. Install the child seat according to the manufacturer's instructions.

### Top Tether

#### Introduction

Top Tether provides an additional connection between the child restraint system secured with a LATCH-type (ISOFIX) system and the vehicle. This helps reduce the risk of injury even further.

If the child restraint system is equipped with a Top Tether belt, this should always be used.

**Important safety notes**

**⚠ WARNING**

If the rear seat backrests are not locked, they could fold forwards in the event of an accident, heavy braking or sudden changes of direction. As a result, child restraint systems cannot perform their intended protective function. Rear seat backrests that are not locked can also cause additional injuries, e.g. in the event of an accident. This poses an increased risk of injury or even fatal injury.

Always lock rear seat backrests after installing a Top Tether belt. Adjust the rear seat backrests so that they are in an upright position.

Make sure that the backrest in the rear compartment engages fully. To do so, pull firmly on the seat backrest.

**Top Tether anchorages**

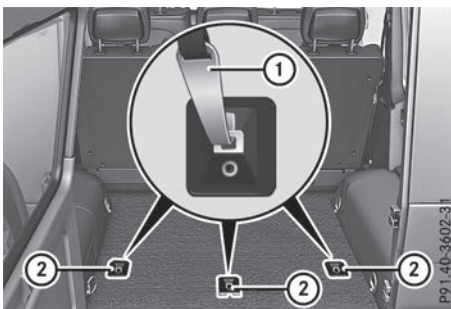

Top Tether anchorages (2) are on the cargo compartment floor.

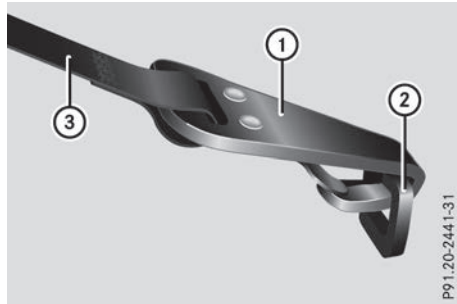

- ▶ Remove cargo compartment cover (▷ page 214).
- ▶ Move the head restraint up.
- ▶ Install the LATCH-type (ISOFIX) child restraint system with Top Tether. Always comply with the child restraint system manufacturer's installation instructions when doing so.
- ▶ Route Top Tether belt (3) under the head restraint between the two head restraint bars.
- ▶ Hook Top Tether hook (1) of Top Tether belt (3) into Top Tether anchorage (2). Make sure that Top Tether belt (3) is not twisted.
- ▶ Tension Top Tether belt (3). Always comply with the child restraint system manufacturer's installation instructions when doing so.
- ▶ Move head restraint back down again slightly if necessary (▷ page 77). Make sure that you do not interfere with the correct routing of Top Tether belt (3).

**BabySmart™ air bag deactivation system**

**⚠ WARNING**

Electronic devices on the front-passenger seat can affect the function of the BabySmart™ air bag deactivation system, for example:

- Laptop
- Mobile phone
- Transponder cards such as ski passes or access passes

The front-passenger air bag could deploy accidentally or not function as intended during an



accident. This poses an increased risk of injury or even fatal injury.

Do not place any of the devices mentioned above or similar devices on the front-passenger seat. Be aware of the status of the front-passenger front air bag both before and during the journey.

The BabySmart™ air bag deactivation system's sensor system in the front-passenger seat detects whether a special Mercedes-Benz child restraint system with a transponder for the BabySmart™ air bag deactivation system has been installed. In this case, the PASSENGER AIR BAG OFF indicator lamp lights up and remains lit. The front-passenger front air bag is deactivated.

When the SmartKey is removed from the ignition lock or is in position , the PASSENGER AIR BAG OFF indicator lamp is not lit.

- i** If the front-passenger front air bag is deactivated by the BabySmart™ air bag deactivation system, the following remain enabled on the front-passenger side:
- the side impact air bag
  - the pelvis air bag
  - the window curtain air bag
  - the Emergency Tensioning Device

 **WARNING**

If you secure a child in a child restraint system on the front-passenger seat and the PASSENGER AIR BAG OFF indicator lamp is off, the front-passenger front air bag can deploy in the event of an accident. The child could be struck by the air bag. This poses an increased risk of injury or even fatal injury.

Make sure that the front-passenger front air bag has been deactivated. The PASSENGER AIR BAG OFF indicator lamp must be lit.

NEVER use a rearward-facing child restraint on a seat protected by an ACTIVE FRONT AIR BAG in front of it; DEATH or SERIOUS INJURY to the child can occur.

 **WARNING**

If the PASSENGER AIR BAG OFF indicator lamp is lit, the front-passenger front air bag is

deactivated. It will not be deployed in the event of an accident and cannot perform its intended protective function. A person in the front-passenger seat could then, for example, come into contact with the vehicle's interior, especially if the person is sitting too close to the dashboard. This poses an increased risk of injury or even fatal injury.

In this case the front-passenger seat may not be used. You may only transport a child on the front-passenger seat if they are seated in a suitable rearward or forward-facing child restraint system. Always observe the child restraint system manufacturer's installation instructions.

 **WARNING**

If you secure a child in a forward-facing child restraint system on the front-passenger seat and you position the front-passenger seat too close to the dashboard, in the event of an accident, the child could:

- come into contact with the vehicle's interior if the PASSENGER AIR BAG OFF indicator lamp is lit, for example
- be struck by the air bag if the PASSENGER AIR BAG OFF indicator lamp is off

This poses an increased risk of injury or even fatal injury.

Move the front-passenger seat as far back as possible. Always make sure that the shoulder belt strap is correctly routed from the vehicle belt sash guide to the shoulder belt guide on the child restraint system. The shoulder belt strap must be routed forwards and downwards from the belt sash guide. If necessary, adjust the belt sash guide and the front-passenger seat accordingly. Always observe the information about suitable positioning of the child restraint system in this Operator's Manual as well as the child restraint system manufacturer's installation instructions.





PASSENGER AIR BAG OFF indicator lamp ① shows you whether the front-passenger front air bag is deactivated.

- ▶ Turn the SmartKey to position ① or ② in the ignition lock.

The system carries out self-diagnostics.

The PASSENGER AIR BAG OFF indicator lamp must light up for approximately six seconds.

**If, after the system self-test, the PASSENGER AIR BAG OFF indicator lamp:**

- **is lit:** the front-passenger front air bag is deactivated. It will then not be deployed in the event of an accident.
- **is not lit,** the sensor system did not detect a child restraint system with transponder for the BabySmart™ air bag deactivation system. If, in the event of an accident, all deployment criteria are met, the front-passenger front air bag is deployed.

### Child restraint system on the front-passenger seat

#### General notes

Accident statistics show that children secured in the rear seats are safer than children secured in the front-passenger seat. For this reason, Mercedes-Benz strongly advises that you install the child restraint system on a rear seat.

If it is absolutely necessary to install a child restraint system on the front-passenger seat, always observe the information on the "BabySmart™ air bag deactivation system" (▷ page 53).

You can thus avoid the risks that could arise as a result of:

- a child restraint system that is not detected by the BabySmart™ air bag deactivation system sensor system
- the unintentional deactivation of the front-passenger front air bag
- the unsuitable positioning of the child restraint system, e.g. too close to the dashboard

#### Rearward-facing child restraint system

If it is absolutely necessary to install a rearward-facing child restraint system on the front-passenger seat, always make sure that the front-passenger front air bag is deactivated. Only if the PASSENGER AIR BAG OFF indicator lamp is permanently lit (▷ page 39) is the front-passenger front air bag deactivated.

Always observe the child restraint system manufacturer's installation and operating instructions.



#### Forward-facing child restraint system

If it is absolutely necessary to install a forward-facing child restraint system on the front-passenger seat, always move the front-passenger seat as far back as possible. The entire base of the child restraint system must always rest on the seat cushion of the front-passenger seat. The backrest of the child restraint system must lie as flat as possible against the backrest of the front-passenger seat. The child restraint system must not touch the roof or be subjected to a load by the head restraint. Adjust the angle of the seat backrest and the head restraint position accordingly.

Always make sure that the shoulder belt strap is correctly routed from the vehicle belt sash guide to the shoulder belt guide on the child restraint system. The shoulder belt strap must be routed forward and down from the vehicle belt sash guide. If necessary, adjust the belt sash guide and the front-passenger seat accordingly.

Always observe the child restraint system manufacturer's installation and operating instructions.

### Problems with the BabySmart™ air bag deactivation system

Problem	Possible causes/consequences and ► Solutions
The PASSENGER AIR BAG OFF indicator lamp on the center console is lit.	<p>A special Mercedes-Benz child restraint system with a transponder for the BabySmart™ air bag deactivation system has been installed on the front-passenger seat. The front-passenger air bag has therefore been deactivated as desired.</p> <p> <b>WARNING</b></p> <p>There is no child restraint system installed on the front-passenger seat. The BabySmart™ air bag deactivation system is malfunctioning, for example due to electronic devices on the front-passenger seat. There is a risk of injury.</p> <p>► Remove electronic equipment from the front-passenger seat, for example:</p> <ul style="list-style-type: none"> <li>• Laptop</li> <li>• Mobile phone</li> <li>• Card with a transponder, such as a ski pass or access pass</li> </ul> <p>If the PASSENGER AIR BAG OFF indicator lamp remains lit, the front-passenger seat may not be used.</p> <p>► Visit a qualified specialist workshop.</p>
When you switch the ignition on, the  restraint system warning lamp lights up and/or the PASSENGER AIR BAG OFF indicator lamp does not light up briefly.	<p> <b>WARNING</b></p> <p>The BabySmart™ air bag deactivation system is malfunctioning. Do not install a child restraint system on the front-passenger seat. It is recommended that you install the child restraint system on a suitable rear seat.</p> <p>► Visit a qualified specialist workshop.</p> <p>► Please also refer to the notes about the restraint system warning lamp (▷ page 198).</p>

### Child-proof locks

#### Important safety notes

##### **WARNING**

If children are traveling in the vehicle, they could:

- open doors, thus endangering other people or road users
- exit the vehicle and be caught by oncoming traffic
- operate vehicle equipment and become trapped

There is a risk of an accident and injury.

Always activate the child-proof locks and override feature if children are traveling in the vehicle. When leaving the vehicle, always take the key with you and lock the vehicle. Never leave children unattended in the vehicle.

Override feature for:

- the rear doors (▷ page 57)
- the rear side windows (▷ page 57)

**⚠ WARNING**

If you leave children unsupervised in the vehicle, they could set it in motion by, for example:

- release the parking brake.
- shift the automatic transmission out of the parking position **P**.
- start the engine.

In addition, they may operate vehicle equipment and become trapped. There is a risk of an accident and injury.

When leaving the vehicle, always take the SmartKey with you and lock the vehicle. Never leave children unsupervised in the vehicle.

**⚠ WARNING**

If persons, particularly children are subjected to prolonged exposure to extreme heat or cold, there is a risk of injury, possibly even fatal. Never leave children unattended in the vehicle.

**⚠ WARNING**

If the child restraint system is subjected to direct sunlight, parts may get very hot. Children may burn themselves on these parts, particularly on the metal parts of the child restraint system. There is a risk of injury.

If you leave the vehicle, taking the child with you, always ensure that the child restraint system is not exposed to direct sunlight. Protect it with a blanket, for example. If the child restraint system has been exposed to direct sunlight, let it cool down before securing the child in it. Never leave children unattended in the vehicle.

**Child-proof locks for the rear side doors and rear door**

Each rear side door and rear door is secured individually with the child-proof locks. A door secured with a child-proof lock cannot be opened from inside the vehicle. When the vehicle is unlocked, the door can be opened from the outside.

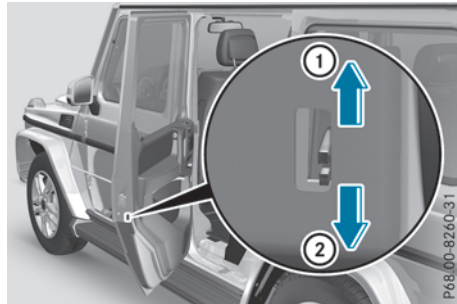

Child-proof locks for the rear side doors

- ▶ **To activate:** press the child-proof lock lever down in the direction of arrow ②.
- ▶ Make sure that the child-proof locks are working properly.
- ▶ **To deactivate:** press the child-proof lock lever up in the direction of arrow ①.

**Override feature for the rear side windows**

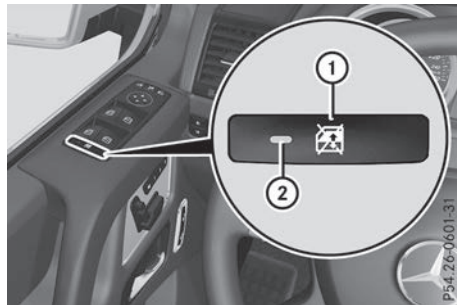

- ▶ **To enable/disable:** press button ①. If indicator lamp ② is lit, operation of the rear side windows is disabled. Operation is only possible using the switches in the driver's door. If indicator lamp ② is off, operation is possible using the switches in the rear compartment.

**Pets in the vehicle**

**⚠ WARNING**

If you leave animals unattended or unsecured in the vehicle, they could press buttons or switches, for example.

As a result, they could:

- activate vehicle equipment and become trapped, for example
- activate or deactivate systems, thereby endangering other road users

Unsecured animals could also be flung around the vehicle in the event of an accident or sudden steering or braking, thereby injuring vehicle occupants. There is a risk of an accident and injury.

Never leave animals unattended in the vehicle. Always secure animals properly during the journey, e.g. use a suitable animal transport box.

## Driving safety systems

### Overview of driving safety systems

In this section, you will find information about the following driving safety systems:

- **ABS (Anti-lock Braking System)** (▷ page 58)
- **BAS (Brake Assist System)** (▷ page 59)
- **ESP® (Electronic Stability Program)** (▷ page 59)
- **EBD (Electronic Brake force Distribution)** (▷ page 61)
- **ADAPTIVE BRAKE** (▷ page 61)

### Important safety notes

If you fail to adapt your driving style or if you are inattentive, the driving safety systems can neither reduce the risk of an accident nor override the laws of physics. Driving safety systems are merely aids designed to assist driving. You are responsible for maintaining the distance to the vehicle in front, for vehicle speed, for braking in good time, and for staying in lane. Always adapt your driving style to suit the prevailing road and weather conditions and maintain a safe distance from the vehicle in front. Drive carefully.

The driving safety systems described only work as effectively as possible when there is adequate contact between the tires and the road surface. Pay particular attention to the information regarding tires, recommended minimum

tire tread depths etc. in the "Wheels and tires" section (▷ page 257).

In wintry driving conditions, always use winter tires (M+S tires) and if necessary, snow chains. Only in this way will the driving safety systems described in this section work as effectively as possible.

## ABS (Anti-lock Braking System)

### General information

ABS regulates brake pressure in such a way that the wheels do not lock when you brake. This allows you to continue steering the vehicle when braking.

The yellow  ABS warning lamp in the instrument cluster lights up when the ignition is switched on. It goes out when the engine is running.

ABS works from a speed of about 5 mph (8 km/h), regardless of road-surface conditions. ABS works on slippery surfaces, even when you only brake gently.

### Important safety notes

 Observe the "Important safety notes" section (▷ page 58).

#### **WARNING**

If ABS is faulty, the wheels could lock when braking. The steerability and braking characteristics may be severely impaired. Additionally, further driving safety systems are deactivated. There is an increased danger of skidding and accidents.

Drive on carefully. Have ABS checked immediately at a qualified specialist workshop.

When ABS is malfunctioning, other systems, including driving safety systems, will also become inoperative. Observe the information on the ABS warning lamp (▷ page 194) and display messages which may be shown in the instrument cluster (▷ page 175).

## Braking

- ▶ **If ABS intervenes:** continue to depress the brake pedal vigorously until the braking situation is over.
- ▶ **To make a full brake application:** depress the brake pedal with full force.

If ABS intervenes when braking, you will feel a pulsing in the brake pedal.

The pulsating brake pedal can be an indication of hazardous road conditions, and functions as a reminder to take extra care while driving.

## Off-road ABS

ESP® automatically activates the ABS system specifically suited to off-road terrain.

At speeds below 37 mph (60 km/h), the front wheels lock cyclically during braking. The digging-in effect achieved in the process reduces the stopping distance on off-road terrain. This limits steering capability.

## BAS (Brake Assist System)

### General information

BAS operates in emergency braking situations. If you depress the brake pedal quickly, BAS automatically boosts the braking force, thus shortening the stopping distance.

### Important safety notes

- ❗ Observe the "Important safety notes" section (▷ page 58).

#### WARNING

If BAS is malfunctioning, the braking distance in an emergency braking situation is increased. There is a risk of an accident.

In an emergency braking situation, depress the brake pedal with full force. ABS prevents the wheels from locking.

## Braking

- ▶ Keep the brake pedal firmly depressed until the emergency braking situation is over. ABS prevents the wheels from locking.

The brakes will function as usual once you release the brake pedal. BAS is deactivated.

## ESP® (Electronic Stability Program)

### General notes

- ❗ Observe the "Important safety notes" section (▷ page 58).

ESP® monitors driving stability and traction, i.e. power transmission between the tires and the road surface.

If ESP® detects that the vehicle is deviating from the direction desired by the driver, one or more wheels are braked to stabilize the vehicle. The engine output is also modified to keep the vehicle on the desired course within physical limits. ESP® assists the driver when pulling away on wet or slippery roads. ESP® can also stabilize the vehicle during braking.

## 4ETS (Electronic Traction System)

- ❗ Observe the "Important safety notes" section (▷ page 58).

4ETS traction control is part of ESP®.

Traction control brakes the drive wheels individually if they spin. This enables you to pull away and accelerate on slippery surfaces, for example if the road surface is slippery on one side. In addition, more drive torque is transferred to the wheel or wheels with traction.

Traction control remains active, even if you deactivate ESP®.

### Important safety notes

- ❗ Observe the "Important safety notes" section (▷ page 58).

#### WARNING

If ESP® is malfunctioning, ESP® is unable to stabilize the vehicle. Additionally, further driving safety systems are deactivated. This increases the risk of skidding and an accident.

Drive on carefully. Have ESP® checked at a qualified specialist workshop.

❗ Only operate the vehicle for a maximum of ten seconds on a brake test dynamometer. Switch off the ignition.

Application of the brakes by ESP® may otherwise destroy the brake system.

❗ A function or performance test should only be carried out on a two-axle dynamometer. Before you operate the vehicle on such a dynamometer, please consult a qualified workshop. You could otherwise damage the drive train or the brake system.

If the  ESP® OFF warning lamp lights up continuously, ESP® is deactivated.

If the  ESP® warning lamp lights up continuously, ESP® is not available due to a malfunction.

Observe the information on warning lamps (▷ page 196) and display messages which may be displayed in the instrument cluster (▷ page 175).

Only use wheels with the recommended tire sizes. Only then will ESP® function properly.

If differential locks are switched on, ABS, BAS and ESP® switch off automatically.

## Characteristics of ESP®

### General information

If the  ESP® warning lamp goes out before beginning the journey, ESP® is automatically active.

If ESP® intervenes, the  ESP® warning lamp flashes in the instrument cluster.

If ESP® intervenes:

- ▶ Do not deactivate ESP® under any circumstances.
- ▶ Only depress the accelerator pedal as far as necessary when pulling away.
- ▶ Adapt your driving style to suit the prevailing road and weather conditions.

### ECO start/stop function

The ECO start/stop function switches the engine off automatically when the vehicle stops moving. The engine starts automatically when the driver wants to pull away again. ESP® remains in its previously selected status, e.g. if ESP® was deactivated before the engine was automatically switched off.

## Deactivating/activating ESP®

### Important safety notes

❗ Observe the "Important safety notes" section (▷ page 58).

You can select between the following states of ESP®:

- ESP® is activated.
- ESP® is deactivated.

### WARNING

If you deactivate ESP®, ESP® no longer stabilizes the vehicle. There is an increased risk of skidding and an accident.

Only deactivate ESP® in the situations described in the following.

It may be best to deactivate ESP® in the following situations:

- when using snow chains
- in deep snow
- on sand or gravel
- off-road

Spinning the wheels results in a cutting action which provides better grip.

Activate ESP® as soon as the situations described above no longer apply. ESP® will otherwise not be able to stabilize the vehicle if the vehicle starts to skid or a wheel starts to spin.

❗ Avoid spinning the driven wheels for an extended period with ESP® deactivated. You could otherwise damage the drivetrain.

## Deactivating/activating ESP®



- ▶ **To deactivate:** press button ①.

The  ESP® OFF warning lamp in the instrument cluster lights up.

- ▶ **To activate:** press button ①.

The  ESP® OFF warning lamp in the instrument cluster goes out.

### Characteristics when ESP® is deactivated

If ESP® is deactivated and one or more wheels start to spin, the  ESP® warning lamp in the instrument cluster flashes. In such situations, ESP® will not stabilize the vehicle.

If you deactivate ESP®:

- ESP® no longer improves driving stability.
- Engine torque is no longer limited and the drive wheels are able to spin.
- Traction control is still activated.
- ESP® still provides support when you brake firmly.
- **Mercedes-AMG vehicles:** and are driving a speed at above 62 mph (100 km/h), ESP® still intervenes when one wheel reaches its grip limit even though it is deactivated.
- **All other models:** and are driving at a speed above 37 mph (60 km/h), ESP® still intervenes when one wheel reaches its grip limit even though it is deactivated.

**Mercedes-AMG vehicles:** if ESP® is deactivated, it is reactivated automatically if you are driving at a speed above 62 mph (100 km/h) or you exceed a certain lateral acceleration.

**All other models:** if ESP® is deactivated, it is reactivated automatically if you are driving at a speed above 37 mph (60 km/h) or you exceed a certain lateral acceleration.

### Trailer stabilization

#### General information

If your vehicle/trailer combination begins to swerve, ESP® assists you in this situation. ESP® slows the vehicle down by braking and limiting the engine output until the vehicle/trailer combination has stabilized.

#### Important safety notes

##### WARNING

If road and weather conditions are poor, trailer stabilization will not be able to prevent

the vehicle/trailer combination from swerving. Trailers with a high center of gravity can tip over before ESP® can detect this. There is a risk of an accident.

Always adapt your driving style to the prevailing road and weather conditions.

If your vehicle with trailer (vehicle/trailer combination) begins to lurch, you can only stabilize the vehicle/trailer combination by depressing the brake firmly.

ESP® trailer stabilization is active above speeds of approximately 37 mph (60 km/h).

ESP® trailer stabilization does not work if ESP® is deactivated or malfunctioning.

### EBD (electronic brake force distribution)

#### General information

EBD monitors and controls the brake pressure on the rear wheels to improve driving stability while braking.

#### Important safety notes

-  Observe the "Important safety notes" section (> page 58).

##### WARNING

If EBD is malfunctioning, the rear wheels can lock, e.g. under full braking. This increases the risk of skidding and an accident.

You should therefore adapt your driving style to the different handling characteristics. Have the brake system checked at a qualified specialist workshop.

Observe information regarding indicator and warning lamps (> page 194) as well as display messages (> page 176).

### ADAPTIVE BRAKE

ADAPTIVE BRAKE provides increased braking safety. In addition to the braking function, ADAPTIVE BRAKE also has the HOLD function (> page 142) and hill start assist (> page 107).

## Protection against theft

### Immobilizer

The immobilizer prevents your vehicle from being started without the correct SmartKey.

- ▶ **To activate:** remove the SmartKey from the ignition lock.
- ▶ **To deactivate:** switch on the ignition.

When leaving the vehicle, always take the SmartKey with you and lock the vehicle. The engine can be started by anyone with a valid SmartKey that is left inside the vehicle.

- ❗ The immobilizer is always deactivated when you start the engine.

In the event that the engine cannot be started (yet the vehicle's battery is charged), the system is not operational. Contact an authorized Mercedes-Benz Center or call 1-800-FOR-MERCEdes (in the USA) or 1-800-387-0100 (in Canada).

### ATA (anti-theft alarm system)



- ▶ **To arm:** lock the vehicle with the SmartKey. Indicator lamp ① flashes. The alarm system is armed after approximately 15 seconds.
- ▶ **To disarm:** unlock the vehicle with the SmartKey.

- ❗ If you then do not open a side door or the rear door, the alarm system switches back on again after approximately 40 seconds.



A visual and audible alarm is triggered if the alarm system is armed and you open:

- a door
- the vehicle with the mechanical key
- the rear door
- the hood

The alarm is also triggered if:

- the position of the vehicle is changed.
- a window is smashed.

The alarm is not switched off, even if you close the open door that triggered it, for example.

- ▶ **To stop the alarm:** press the  or  button on the SmartKey. The alarm is stopped.

or

- ▶ Insert the SmartKey into the ignition lock. The alarm is stopped.

- ❗ If the alarm continues for more than 30 seconds, the mbrace emergency call system automatically notifies the Customer Assistance Center. This is done either by text message or data connection.

The emergency call system sends the message or data provided that:

- you have subscribed to the mbrace service.
- the mbrace service has been activated properly.
- the necessary mobile phone network is available.



## SmartKey

### Important safety notes

#### WARNING

If children are left unsupervised in the vehicle, they could:

- open the doors, thus endangering other people or road users.
- get out and disrupt traffic.
- operate the vehicle's equipment.

Additionally, children could set the vehicle in motion if, for example, they:

- release the parking brake.
- shifting the automatic transmission out of park position **P**
- Start the engine.

There is a risk of an accident and injury.

When leaving the vehicle, always take the SmartKey with you and lock the vehicle. Never leave children or animals unattended in the vehicle. Always keep the SmartKey out of reach of children.

#### WARNING

If you attach heavy or large objects to the SmartKey, the SmartKey could be unintentionally turned in the ignition lock. This could cause the engine to be switched off. There is a risk of an accident.

Do not attach any heavy or large objects to the SmartKey. Remove any bulky key rings before inserting the SmartKey into the ignition lock.

- !** Keep the SmartKey away from strong magnetic fields. Otherwise, the remote control function could be affected.

Strong magnetic fields can occur in the vicinity of powerful electrical installations.

Do not keep the SmartKey:

- with electronic devices, e.g. a mobile phone or another SmartKey.
- with metallic objects, e.g. coins or metal foil.
- inside metallic objects, e.g. a metal case.



This can affect the functionality of the SmartKey.

A check which periodically establishes a radio connection between the vehicle and the SmartKey determines whether a valid SmartKey is in the vehicle. This occurs, for example:

- when starting the engine
- while driving

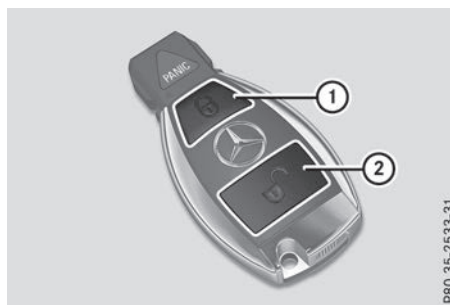
### SmartKey functions



- ①  Locks the vehicle
- ②  Unlocks the vehicle

The SmartKey centrally locks/unlocks:

- the doors
- the rear door
- the fuel filler flap

► **To unlock centrally:** press the  button.

If you do not open the vehicle within approximately 40 seconds of unlocking:

- the vehicle is locked again.
- protection against theft is reactivated.

► **To lock centrally:** press the  button.

The turn signals flash once when unlocking and three times when locking.



You can also set an audible signal to confirm that the vehicle has been locked. The audible signal can be activated and deactivated using the on-board computer (► page 170).



You will receive visual and acoustic locking confirmation if all components were able to be locked.

When the surround lighting is activated via the on-board computer, it lights up when it is dark after the vehicle is unlocked with the SmartKey (► page 169).

### Changing the settings of the locking system





You can change the settings of the locking system. This means that only the driver's door and the fuel filler flap are unlocked when the vehicle is unlocked. This is useful if you frequently travel alone.

- ▶ **To change the setting:** press and hold down the  and  buttons simultaneously for approximately six seconds until the battery check lamp (▷ page 65) flashes twice.

If the setting of the locking system is changed within the signal range of the vehicle, pressing the  or  button:

- locks or
- unlocks the vehicle

The SmartKey now functions as follows:

- ▶ **To unlock the driver's door and fuel filler flap:** press the  button once.
- ▶ **To unlock centrally:** press the  button twice.
- ▶ **To lock centrally:** press the  button.
- ▶ **To restore the factory settings:** press and hold the  and  buttons simultaneously for approximately six seconds until the battery check lamp (▷ page 65) flashes twice.

### Mechanical key

#### General notes

If the vehicle can no longer be unlocked with the SmartKey, use the mechanical key.

If you use the mechanical key to unlock and open the driver's door, the anti-theft alarm system will be triggered. Switch off the alarm (▷ page 62).

If you unlock the vehicle using the mechanical key, the fuel filler flap will not be unlocked automatically.

- ▶ **To unlock the fuel filler flap:** insert the SmartKey into the ignition lock.

### Removing the mechanical key

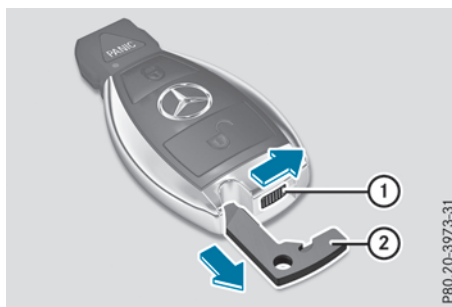

- ▶ Push release catch ① in the direction of the arrow and at the same time remove mechanical key ② from the SmartKey.

Further information on locking/unlocking the driver's door (▷ page 68).

### Inserting the mechanical key

- ▶ Push mechanical key ② completely into the SmartKey until it engages and release catch ① is back in its basic position.

### SmartKey battery

#### Important safety notes

##### WARNING

Batteries contain toxic and corrosive substances. If batteries are swallowed, it can result in severe health problems. There is a risk of fatal injury.

Keep batteries out of the reach of children. If a battery is swallowed, seek medical attention immediately.

##### Environmental note



Batteries contain dangerous substances. It is against the law to dispose of them with the household rubbish. They must be collected separately.



and recycled to protect the environment.

Dispose of batteries in an environmentally friendly manner. Take discharged batteries to a qualified specialist workshop or a special collection point for used batteries.

The SmartKey batteries contain perchlorate material, which may require special handling and regard for the environment. National guidelines must be observed during disposal. In California, see [www.dtsc.ca.gov/HazardousWaste/Perchlorate/index.cfm](http://www.dtsc.ca.gov/HazardousWaste/Perchlorate/index.cfm).

Mercedes-Benz recommends that you have the batteries replaced at a qualified specialist workshop.

### Checking the battery



P80.35-2538-31

- ▶ Press the or button. The battery is working properly if battery check lamp ① lights up briefly. The battery is discharged if battery check lamp ① does not light up briefly.
- ▶ Change the battery (▷ page 65).

If the SmartKey battery is checked within the signal reception range of the vehicle, pressing the or button:

- locks or
- unlocks the vehicle

**i** You can get a battery at any qualified specialist workshop.

### Replacing the battery

You require a CR 2025 3 V cell battery.

- ▶ Take the mechanical key out of the SmartKey (▷ page 64).

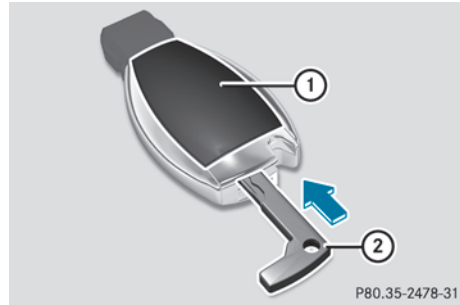

P80.35-2478-31

- ▶ Press mechanical key ② in the direction of the arrow into the opening in the SmartKey until battery compartment cover ① opens. Do not hold battery compartment cover ① closed while doing so.
- ▶ Remove battery compartment cover ①.

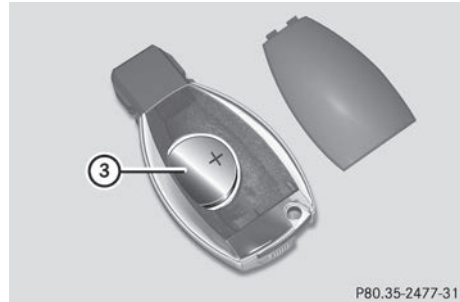

P80.35-2477-31

- ▶ Repeatedly tap the SmartKey against your palm until battery ③ falls out.
- ▶ Insert the new battery with the positive terminal facing upwards. Use a lint-free cloth to do so.
- ▶ Make sure that the surface of the battery is free of lint, grease and other contaminants.
- ▶ Insert the front tabs of battery compartment cover ① into the housing first and then press to close it.
- ▶ Insert mechanical key ② into the SmartKey (▷ page 64).
- ▶ Check the function of all SmartKey buttons on the vehicle.

### Problems with the SmartKey

Problem	Possible causes/consequences and ► Solutions
You can no longer lock or unlock the vehicle using the SmartKey.	<p>The SmartKey battery is discharged or nearly discharged.</p> <ul style="list-style-type: none"> <li>► Check the SmartKey battery (▷ page 65) and replace it if necessary (▷ page 65).</li> </ul> <p>If this does not work:</p> <ul style="list-style-type: none"> <li>► Lock or unlock the vehicle using the mechanical key (▷ page 68).</li> </ul> <p>There is interference from a powerful source of radio waves.</p> <ul style="list-style-type: none"> <li>► Lock or unlock the vehicle using the mechanical key (▷ page 68).</li> </ul> <p>The SmartKey is faulty.</p> <ul style="list-style-type: none"> <li>► Lock or unlock the vehicle using the mechanical key (▷ page 68).</li> <li>► Have the SmartKey checked at a qualified specialist workshop.</li> </ul>
The engine cannot be started using the SmartKey.	<p>The on-board voltage is too low</p> <ul style="list-style-type: none"> <li>► Switch off non-essential consumers, e.g. seat heating or interior lighting, and try to start the engine again.</li> </ul> <p>If this does not work:</p> <ul style="list-style-type: none"> <li>► Check the starter battery and charge it if necessary (▷ page 248).</li> <li>or</li> <li>► Jump-start the vehicle (▷ page 249).</li> <li>or</li> <li>► Consult a qualified specialist workshop.</li> </ul>
You have lost a SmartKey.	<ul style="list-style-type: none"> <li>► Have the SmartKey deactivated at a qualified specialist workshop.</li> <li>► Report the loss immediately to the vehicle insurers.</li> <li>► If necessary, have the locks changed as well.</li> </ul>
You have lost the mechanical key.	<ul style="list-style-type: none"> <li>► Report the loss immediately to the vehicle insurers.</li> <li>► If necessary, have the locks changed as well.</li> </ul>

### Doors

#### Important safety notes

#### WARNING

If children are left unsupervised in the vehicle, they could:

- open the doors, thus endangering other people or road users.
- get out and disrupt traffic.
- operate the vehicle's equipment.

Additionally, children could set the vehicle in motion if, for example, they:

- release the parking brake.
- shifting the automatic transmission out of park position **P**
- Start the engine.

There is a risk of an accident and injury.

When leaving the vehicle, always take the SmartKey with you and lock the vehicle. Never leave children or animals unattended in the vehicle. Always keep the SmartKey out of reach of children.

### Unlocking and opening doors from the inside

You can open a door from inside the vehicle even if it has been locked. You can only open the rear doors from inside the vehicle if they are not secured by the child-proof locks (▷ page 57). If the vehicle has previously been locked with the SmartKey, opening a door from the inside will trigger the anti-theft alarm system. Switch off the alarm (▷ page 62).

Only open the door when the traffic situation permits.



- ▶ **Front doors:** pull door handle ②.  
If the door is locked, locking knob ① pops up. The door is unlocked and can be opened.
- ▶ **Rear doors:** pull the locking knob of the rear door up.  
The door is unlocked.
- ▶ Pull the door handle on the rear door.

### Centrally locking and unlocking the vehicle from the inside

You can centrally lock or unlock the vehicle from the inside.

The central locking button does not lock or unlock the fuel filler flap.

The switches are on the driver's door.



▶ **To unlock:** press button ①.

▶ **To lock:** press button ②.

If all the doors are closed, the vehicle locks.

The doors can be opened from the inside. You can only open the rear doors from inside the vehicle if they are not secured by the child-proof locks (▷ page 57)

You cannot unlock the vehicle centrally from the inside if the vehicle has been locked with the SmartKey.

If a locked door is opened from the inside, the previous unlock status of the vehicle will be taken into consideration if:

- the vehicle was locked using the locking button for the central locking, or
- locked automatically

The vehicle will be fully unlocked if it had previously been fully unlocked. If only the driver's door had been previously unlocked, only the door which has been opened from the inside is unlocked.

### Automatic locking feature



- ▶ **To deactivate:** press and hold button ① for approximately five seconds until a tone sounds.
- ▶ **To activate:** press and hold button ② for approximately five seconds until a tone sounds.

If you press one of the two buttons and do not hear a tone, the relevant setting has already been selected.

The vehicle is locked automatically when the ignition is switched on and the wheels are turning.

You could therefore be locked out if:

- the vehicle is being pushed.
- the vehicle is being towed.
- the vehicle is being tested on a dynamometer.

You can also switch the automatic locking function on and off using the on-board computer (▷ page 170).

#### Locking/unlocking the driver's door with the mechanical key

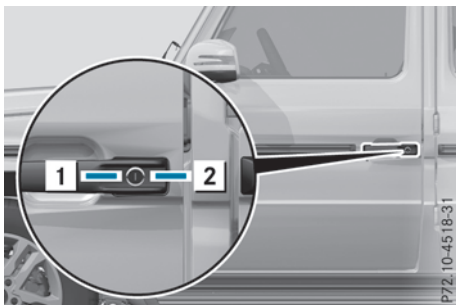

- ▶ Insert the mechanical key into the lock of the driver's door as far as it will go.
- ▶ **To unlock:** turn the mechanical key counter-clockwise as far as it will go to position 1.
- ▶ **To lock:** turn the mechanical key clockwise as far as it will go to position 2.

If you use the mechanical key to unlock and open the driver's door, the anti-theft alarm system will be triggered. Switch off the alarm (▷ page 62).

## Rear door

### Important safety notes

#### ⚠ WARNING

Combustion engines emit poisonous exhaust gases such as carbon monoxide. If the rear door is open when the engine is running, particularly if the vehicle is moving, exhaust fumes could enter the passenger compartment. There is a risk of poisoning.

Turn off the engine before opening the rear door. Never drive with the rear door open.

#### ⚠ WARNING

If objects, luggage or loads are not secured or not secured sufficiently, they could slip, tip over or be flung around and thereby hit vehicle occupants. There is a risk of injury, particularly in the event of sudden braking or a sudden change in direction.

Always store objects so that they cannot be flung around. Secure objects, luggage or loads against slipping or tipping before the journey.

- ⚠ The tailgate swings out to the side when opened. Therefore, make sure that there is sufficient clearance.

Do not leave the SmartKey in the cargo compartment. Otherwise, you could lock yourself out.

You should preferably place luggage or loads in the cargo compartment. Observe the loading guidelines (▷ page 209).

### Opening

The rear door must be unlocked before it can be opened.

- ▶ Press the  button on the SmartKey.

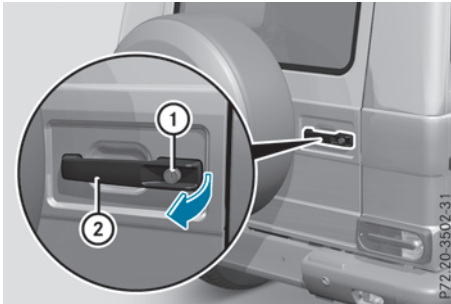

- ▶ Press release button ① and pull door handle ②.
- ▶ Open the rear door.

### Closing

- ▶ Push the rear door closed from outside the vehicle.
- ▶ Lock the vehicle with the  button on the SmartKey.

## Side windows

### Important safety notes

#### WARNING

While opening the side windows, body parts could become trapped between the side window and the door frame as the side window moves. There is a risk of injury.

Make sure that nobody touches the side window during the opening procedure. If somebody becomes trapped, release the switch or pull the switch to close the side window again.

#### WARNING

While closing the side windows, body parts in the closing area could become trapped. There is a risk of injury.

When closing make sure that no parts of the body are in the closing area. If somebody becomes trapped, release the switch or press the switch to open the side window again.

#### WARNING

If children operate the side windows they could become trapped, particularly if they are left unsupervised. There is a risk of injury.

Activate the override feature for the rear side windows. When leaving the vehicle, always take the SmartKey with you and lock the vehicle. Never leave children unsupervised in the vehicle.

### Opening and closing the side windows

The switches for all side windows are located on the driver's door. There is also a switch on each door for the corresponding side window.

The switches on the driver's door take precedence.

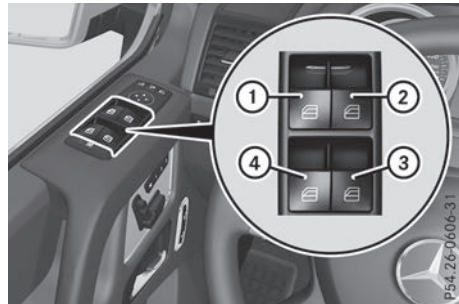

- ① Front left
- ② Front right
- ③ Rear right
- ④ Rear left

- ▶ Turn the SmartKey to position ① or ② in the ignition lock.
- ▶ **To open manually:** press and hold the corresponding switch.
- ▶ **To open automatically:** press the corresponding switch beyond the point of resistance and release it. Automatic operation is started.
- ▶ **To interrupt automatic operation:** press/pull the corresponding switch again.
- ▶ **To close manually:** pull the corresponding switch and hold it.

You can continue to operate the side windows after you switch off the engine or remove the



SmartKey. This function remains active for five minutes or until you open a front door.

The side windows cannot be operated from the rear when the override feature for the side windows is activated (▷ page 57).

### Convenience opening

**i** The convenience opening feature can only be operated using the SmartKey. The SmartKey must be close to the driver's door handle.

You can ventilate the vehicle before you start driving. To do this, the SmartKey is used to carry out the following functions simultaneously:

- unlock the vehicle
- open the side windows
- open the sliding sunroof
- switch on the seat ventilation for the driver's and front-passenger seat
- ▶ Point the tip of the SmartKey at the driver's door handle.
- ▶ Press and hold the  button on the SmartKey until the side windows and the sliding sunroof are in the desired position.
- ▶ **To interrupt convenience opening:** release the  button.

### Convenience closing feature

#### Important safety notes

#### WARNING

When the convenience closing feature is operating, parts of the body could become trapped



in the closing area of the side window and the sliding sunroof. There is a risk of injury.

Observe the complete closing procedure when the convenience closing feature is operating. Make sure that no body parts are in close proximity during the closing procedure.

#### Operation

**i** The "convenience closing feature" can only be operated using the SmartKey. The SmartKey must be close to the driver's door handle.

When you lock the vehicle, you can simultaneously:

- close the side windows
- close the sliding sunroof
- ▶ Point the tip of the SmartKey at the driver's door handle.
- ▶ Press and hold the  button on the SmartKey until the side windows and the sliding sunroof are fully closed.
- ▶ Make sure that all the side windows and the sliding sunroof are closed.
- ▶ **To interrupt convenience closing:** release the  button.

### Problems with the side windows

#### WARNING

Closing the side windows with increased force or without the anti-entrapment feature could lead to serious or even fatal injury. Make sure that nobody can become trapped when closing the side windows.



Problem	Possible causes/consequences and ► Solutions
A side window cannot be closed because it is blocked by objects, e.g. leaves in the window guide.	<ul style="list-style-type: none"> <li>► Remove the objects.</li> <li>► Close the side window.</li> </ul>
A side window cannot be closed and you cannot see the cause.	<p>If a side window is obstructed during closing and reopens again slightly:</p> <ul style="list-style-type: none"> <li>► Immediately after the window blocks, pull the corresponding switch again until the side window has closed.</li> </ul> <p>If a side window is obstructed again during closing and reopens again slightly:</p> <ul style="list-style-type: none"> <li>► Immediately after the window blocks, pull the corresponding switch again until the side window has closed.</li> </ul>
The side windows cannot be opened or closed with convenience opening.	<p>The SmartKey battery is discharged or nearly discharged.</p> <ul style="list-style-type: none"> <li>► Check the SmartKey battery (► page 65) and replace it if necessary (► page 65).</li> </ul>

If a side window will still not open or close due to a malfunction, consult a qualified specialist workshop.

## Sliding sunroof

### Important safety notes

#### WARNING

While opening and closing the sliding sunroof, body parts in close proximity could become trapped. There is a risk of injury.

Make sure that no body parts are in close proximity during the opening and closing procedures.

If somebody becomes trapped:

- release the switch immediately, or
- during automatic operation, push the switch briefly in any direction

The opening or closing procedure will be stopped.

#### WARNING

If children operate the sliding sunroof they could become trapped, particularly if they are left unsupervised. There is a risk of injury.

When leaving the vehicle, always take the SmartKey with you and lock the vehicle. Never leave children unsupervised in the vehicle.

 Only open the sliding sunroof if it is free of snow and ice. Otherwise, malfunctions may occur.

Do not allow anything to protrude from the sliding sunroof. Otherwise, the seals could be damaged.



 The weather can change abruptly. It could start to rain or snow. Make sure that the sliding sunroof is closed when you leave the vehicle. The vehicle electronics can be damaged if water enters the vehicle interior.

Resonance noises can occur in addition to the usual airflow noises when the sliding sunroof is open. They are caused by minor pressure fluctuations in the vehicle interior. Change the position of the sliding sunroof or open a side window slightly to reduce or eliminate these noises.

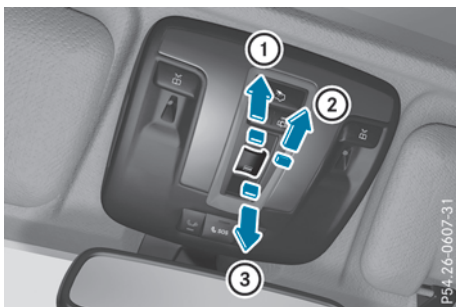
### Opening and closing the sliding sunroof



- ① To raise
- ② To open
- ③ To close/lower

- ▶ Turn the SmartKey to position ① or ② in the ignition lock.
- ▶ Press or pull the  switch in the corresponding direction.
- ▶ **To open automatically:** press the  switch briefly beyond the pressure point in the direction of arrow ②. The sliding sunroof opens completely.
- ▶ **To interrupt automatic operation:** press or pull the  switch again.

Automatic operation for opening or raising is only available when the sliding sunroof is closed.

- ❗ The sliding sunroof cannot be raised when a roof rack is installed.

### Operating the sliding sunroof manually

The actuator motor for the sliding sunroof is located on the left-hand side of the cargo compartment, behind the rear panel trim.

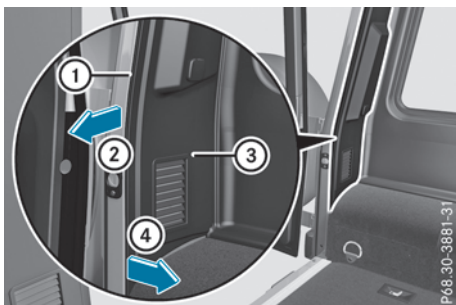

### Removing the rear panel trim

- ▶ Open the rear door.
- ▶ Remove edge protection ① on door pillar in the direction of arrow ②.
- ▶ Pull rear panel trim ③ in the direction of arrow ④ as far as necessary, so that the electrical connections can be reached.
- ▶ Disconnect the electrical connections.
- ▶ Completely remove rear panel trim ③.

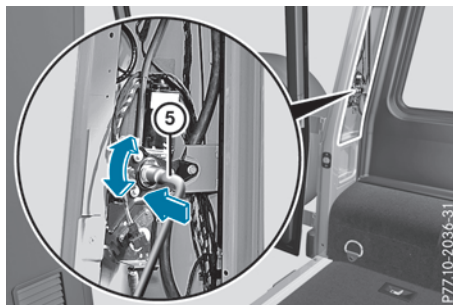

### Opening/closing the sliding sunroof manually

- ▶ Remove lug wrench ⑤ from the vehicle tool kit (> page 244).
- ▶ Place lug wrench ⑤ onto the hexagon nut of the actuator motor.
- ▶ **To open:** turn lug wrench ⑤ counter-clockwise.
- ▶ **To close:** turn lug wrench ⑤ clockwise.

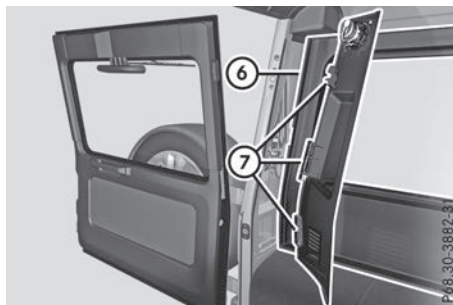



### Installing the rear panel trim

- ▶ Connect the electrical connections.
- ▶ Insert rear panel trim ③. Hook tabs ⑦ of rear panel trim ③ into vehicle side wall ⑥.
- ▶ Insert edge protection ①.
- ▶ Close the rear door.

### Problems with the sliding sunroof

#### WARNING

You could be severely or even fatally injured when closing the sliding sunroof with increased closing force or if the anti-entrapment feature is deactivated. Make sure that nobody can become trapped when closing the sliding sunroof.

Problem	Possible causes/consequences and ► Solutions
The sliding sunroof cannot be closed and you cannot see the cause.	<p>If the sliding sunroof is obstructed during closing and reopens again slightly:</p> <ul style="list-style-type: none"> <li>► Immediately after it blocks, pull the  switch down again to the point of resistance until the sliding sunroof is closed.</li> </ul> <p>If the sliding sunroof is obstructed again during closing and then reopens slightly:</p> <ul style="list-style-type: none"> <li>► Immediately after it blocks, pull the  switch down again to the point of resistance until the sliding sunroof is closed.</li> </ul>

If the sliding sunroof will still not open or close due to a malfunction, consult a qualified specialist workshop.

### Correct driver's seat position



- ① Steering wheel
- ② Seat belts
- ③ Backrest

- ▶ Observe the safety guidelines on seat adjustment (▷ page 74).
- ▶ Make sure that seat ③ is adjusted properly. Electrical seat adjustment (▷ page 76)

When adjusting the seat, make sure that:

- you are as far away from the driver's air bag as possible
- you are sitting in a normal upright position
- you can fasten the seat belt properly
- you have moved the backrest to an almost vertical position
- you have set the seat cushion angle so that your thighs are gently supported
- you can depress the pedals properly
- ▶ Check whether the head restraint is adjusted properly (▷ page 76).

When doing so, make sure that you have adjusted the head restraint so that the back of your head is supported at eye level by the center of the head restraint.

- ▶ Observe the safety guidelines on steering wheel adjustment (▷ page 74).
- ▶ Make sure that steering wheel ① is adjusted properly.  
Adjusting the steering wheel electrically (▷ page 80).

When adjusting the steering wheel, make sure that:

- you can hold the steering wheel with your arms slightly bent
- you can move your legs freely
- you can see all the displays in the instrument cluster clearly
- ▶ Observe the safety guidelines for seat belts (▷ page 40).
- ▶ Check whether you have fastened seat belt ② properly (▷ page 41).

The seat belt should:

- fit snugly across your body
- be routed across the middle of your shoulder
- be routed across your hips in the pelvic area
- ▶ Before starting off, adjust the rear-view mirror and the exterior mirrors in such a way that you have a good view of road and traffic conditions (▷ page 82).
- ▶ **Vehicles with a memory function:** save the seat, steering wheel and exterior mirror settings with the memory function (▷ page 84).

## Seats

### Important safety notes

#### ⚠ WARNING

Children could become trapped if they adjust the seats, particularly when unattended. There is a risk of injury.

When leaving the vehicle, always take the SmartKey with you and lock the vehicle. Never leave children unsupervised in the vehicle.

The seats can still be adjusted when there is no SmartKey in the ignition lock.

#### ⚠ WARNING

When you adjust a seat, you or other vehicle occupants could become trapped, e.g. on the seat guide rail. There is a risk of injury.

Make sure when adjusting a seat that no one has any body parts in the sweep of the seat.

Observe the safety notes on "Air bags" (▷ page 44) and "Children in the vehicle" (▷ page 50).

**⚠ WARNING**

You could lose control of your vehicle if you do the following while driving:

- adjust the driver's seat, head restraint, steering wheel or mirrors
- fasten the seat belt

There is a risk of an accident.

Adjust the driver's seat, head restraint, steering wheel and mirror and fasten your seat belt before starting the engine.

**⚠ WARNING**

If the head restraints are not installed or not adjusted correctly, they cannot provide protection as intended. There is an increased risk of injury in the head and neck area, e.g. in the event of an accident or when braking.

Always drive with the head restraints installed. Before driving off, make sure for every vehicle occupant that the center of the head restraint supports the back of the head at about eye level.

Make sure that you do not rotate the head restraints of the front and rear seats when adjusting the head restraints. Otherwise, you cannot adjust the height and angle of the head restraints correctly.

Adjust the head restraint so that it is as close as possible to your head.

**⚠ WARNING**

If you adjust the seat height carelessly, you or other vehicle occupants could be trapped and thereby injured. Children in particular could accidentally press the electrical seat adjustment buttons and become trapped. There is a risk of injury.

While moving the seats, make sure that your hands or other body parts do not get under the lever assembly of the seat adjustment system.

**⚠ WARNING**

When you adjust a seat, you or other vehicle occupants could become trapped, e.g. on the seat guide rail. There is a risk of injury.

Make sure when adjusting a seat that no one has any body parts in the sweep of the seat.

**!** To avoid damage to the seats and the seat heating, observe the following information:

- keep liquids from spilling on the seats. If liquid is spilled on the seats, dry them as soon as possible.
- if the seat covers are damp or wet, do not switch on the seat heating. The seat heating should also not be used to dry the seats.
- clean the seat covers as recommended; see "Interior care".
- do not transport heavy loads on the seats. Do not place sharp objects on the seat cushions, e.g. knives, nails or tools. The seats should only be occupied by passengers, if possible.
- when the seat heating is in operation, do not cover the seats with insulating materials, e.g. blankets, coats, bags, seat covers, child seats or booster seats.

**!** Make sure that there are no objects in the footwell under or behind the seats when moving the seats back. There is a risk that the seats and/or the objects could be damaged.

**!** When the rear bench seat is folded forwards, the front seats cannot be moved to their rearmost position. You could otherwise damage the seats and the rear bench seat.

**!** Make sure that the sun visor is folded up before adjusting the backrest and head restraint height. The head restraint and sun visor could otherwise collide when the head restraint is fully extended.

**i** If the front door is open, the seats can be adjusted for up to 30 minutes after the ignition has been switched off.

**i** The rear-compartment head restraints can be removed (▷ page 77).

For more information, contact a qualified specialist workshop.

**i** You can find further information about enlarging the cargo compartment (folding the rear bench seat forwards) on (▷ page 213).

### Adjusting the seats electrically

- ❗ Make sure that the cup holder on the center console is folded down before you move the front-passenger seat forwards.

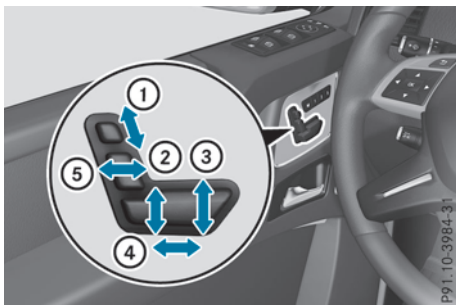

- ① Head restraint height
- ② Seat height
- ③ Seat cushion angle
- ④ Seat fore-and-aft adjustment
- ⑤ Backrest angle

- ❗ You can store the seat settings using the memory function (▷ page 84).

### Adjusting the head restraints

#### Important safety notes

#### ⚠ WARNING

If the head restraints are not installed or not adjusted correctly, they cannot provide protection as intended. There is an increased risk of injury in the head and neck area, e.g. in the event of an accident or when braking.

Always drive with the head restraints installed. Before driving off, make sure for every vehicle occupant that the center of the head restraint supports the back of the head at about eye level.

Observe the following when adjusting the head restraints:

- ▶ Do not rotate the head restraints of the front and rear seats. Otherwise, you cannot adjust the height and angle of the head restraints correctly.
- ▶ Adjust the head restraint so that it is as close as possible to your head.

### Adjusting the front seat head restraint height

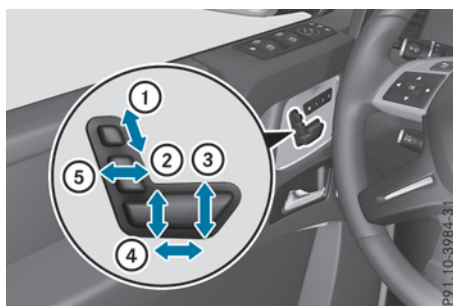

- ① Head restraint height
- ② Seat height
- ③ Seat cushion angle
- ④ Seat fore-and-aft adjustment
- ⑤ Backrest angle

- ▶ Slide head restraint adjustment button ① up or down in the direction of the arrow.

### Adjusting the luxury head restraints

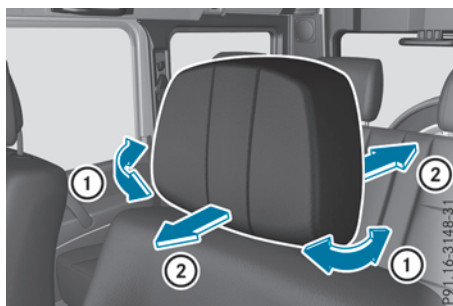

- ▶ **To adjust the side bolsters of the head restraint:** push or pull right and/or left-hand side bolster ① into the desired position.
- ▶ **To adjust the angle of the head restraint:** push or pull the head restraint in the direction of arrow ②.

### Resetting the front seat head restraints

It is necessary to reset the front seat head restraints after the voltage supply has been interrupted, e.g. if the battery has been completely discharged or disconnected.

- ▶ Make sure that the cup holder on the center console is folded down (> page 215).
- ▶ Move the seat as far forward as possible and the head restraint in as far as possible.

### Rear seat head restraints

#### Important safety notes

##### WARNING

If the head restraints are not installed or not adjusted correctly, they cannot provide protection as intended. There is an increased risk of injury in the head and neck area, e.g. in the event of an accident or when braking.

Always drive with the head restraints installed. Before driving off, make sure for every vehicle occupant that the center of the head restraint supports the back of the head at about eye level.

Observe the following when adjusting the head restraints:

- ▶ Do not rotate the head restraints of the front and rear seats. Otherwise, you cannot adjust the height and angle of the head restraints correctly.
- ▶ Adjust the head restraint so that it is as close as possible to your head.

#### Adjusting the rear seat head restraint height

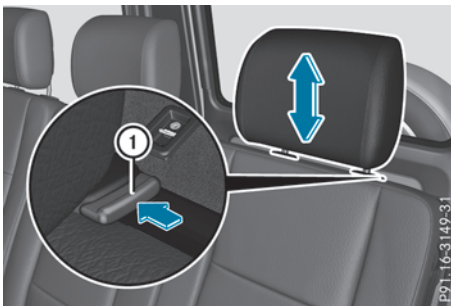

- ▶ Once the head restraint is fully lowered, press release catch ①.
- ▶ **To raise:** pull the head restraint up to the desired position.
- ▶ **To lower:** press release catch ① and push the head restraint down until it is in the desired position.

#### Installing/removing the rear seat head restraints

- ▶ **To remove:** pull the head restraint up to the stop.
  - ▶ Press release catch ① and pull the head restraint out of the guides.
  - ▶ **To re-install:** place the head restraint in the guides of the backrest.
- i** The notches on the guide rod must be on the left-hand side when viewed in the direction of travel.
- ▶ Push the head restraint down until you hear it engage in position.

#### Adjusting the multicontour seat

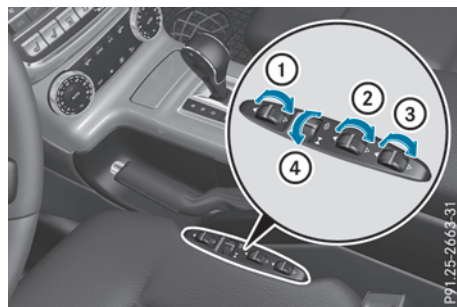

- ① To adjust the thigh cushion
- ② To adjust the backrest contour in the lumbar region
- ③ To adjust the backrest contour in the upper back region
- ④ To adjust the side bolsters of the seat backrest

You can adjust the contour of the front seats individually so as to provide optimum support for your back and sides.

- ▶ Make sure that the SmartKey is in position **1** or **2** in the ignition lock (> page 105).

### Adjusting the 4-way lumbar support

You can adjust the contour of the front seat backrests individually to provide optimum support for your back.

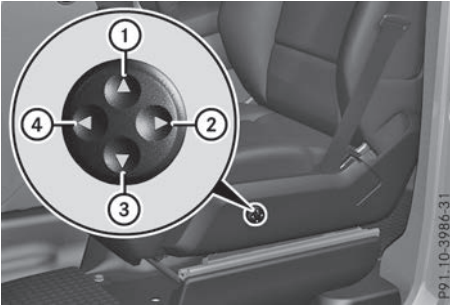

- ① Raises the backrest contour
- ② Softens the backrest contour
- ③ Lowers the backrest contour
- ④ Hardens the backrest contour

### Switching the seat heating on/off

#### General notes

#### WARNING

Repeatedly switching on the seat heating can cause the seat cushion and backrest pads to become very hot. The health of persons with limited temperature sensitivity or a limited ability to react to high temperatures may be affected or they may even suffer burn-like injuries. There is a risk of injury.

Therefore, do not switch the seat heating on repeatedly.

- ❗ Heat accumulation can occur if the seat heating is switched on and there are objects or underlays placed on the seats, e.g. seat cushions or child seats.

This can lead to damage to the seat surface. Make sure that no objects or underlays are placed on the seats when the seat heating is switched on.

The red indicator lamps in the button indicate the heating level you have selected.



- ▶ Make sure that the SmartKey is in position  in the ignition lock.

- ❗ If the battery voltage is too low, the seat heating may switch off.

One or more of the indicator lamps in the seat heating button are flashing.

### Switching the front-seat heating on/off



- ▶ **To switch on:** press button  repeatedly until the desired heating level is set.
- ▶ **To switch off:** press button  repeatedly until all the indicator lamps go out.



- ❗ The system automatically switches from level **3** to level **2** after approximately eight minutes.

The system automatically switches down from level **2** to level **1** after approximately ten minutes.

The system automatically switches off approximately 35 minutes after it is set to level **1**.

### Switching the rear-seat heating on/off



- ▶ **To switch on:** press button  repeatedly until the desired heating level is set.
- ▶ **To switch off:** press button  repeatedly until all the indicator lamps go out.



- i** The system automatically switches from level **3** to level **2** after approximately eight minutes.

The system automatically switches down from level **2** to level **1** after approximately ten minutes.

The system automatically switches off approximately 35 minutes after it is set to level **1**.

### Switching the seat ventilation on/off

#### Switching on/off



Seat ventilation is only available for the front seats.

The three blue indicator lamps in the buttons indicate the ventilation level you have selected.

- ▶ Make sure that the SmartKey is in position **2** in the ignition lock (▷ page 105).

- ▶ **To switch on:** press button **1** repeatedly until the desired ventilation level is set.

- i** If you open the side windows and the sliding sunroof using the SmartKey (▷ page 70), the driver's seat ventilation automatically switches to the highest level.

- ▶ **To switch off:** press button **1** repeatedly until all the indicator lamps go out.

- i** If the battery voltage is too low, the seat ventilation may switch off.

### Problems with the seat heating/seat ventilation

Problem	Possible causes/consequences and ▶ Solutions
The seat heating or seat ventilation has switched off prematurely or cannot be switched on.	<p>The on-board voltage is too low because too many electrical consumers are switched on.</p> <ul style="list-style-type: none"> <li>▶ Switch off electrical consumers that you do not need, such as the rear window defroster or interior lighting.</li> </ul> <p>Once the battery is sufficiently charged, the seat heating or seat ventilation can be switched back on manually.</p>

### Steering wheel

#### Important safety notes

##### **⚠ WARNING**

You could lose control of your vehicle if you do the following while driving:

- adjust the driver's seat, head restraint, steering wheel or mirrors
- fasten the seat belt

There is a risk of an accident.

Adjust the driver's seat, head restraint, steering wheel and mirror and fasten your seat belt before starting the engine.

##### **⚠ WARNING**

Children could injure themselves if they adjust the steering wheel. There is a risk of injury.

When leaving the vehicle, always take the SmartKey with you and lock the vehicle. Never leave children unsupervised in the vehicle.

The electrically adjustable steering wheel can still be adjusted when there is no SmartKey in the ignition lock.

### Adjusting the steering wheel

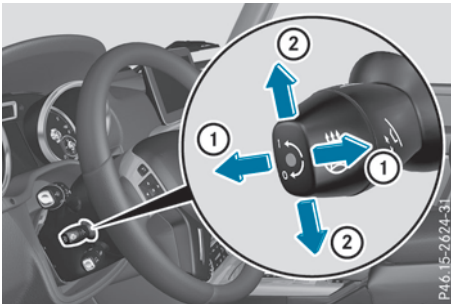

- ① Adjusts the steering wheel position (fore-and-aft adjustment)
- ② Adjusts the steering wheel height
- i** If the driver's door is open, the steering wheel can be adjusted for up to 30 minutes after the ignition has been switched off.
- i** Further related subjects:
  - EASY-ENTRY/EXIT feature (▷ page 81)
  - Storing settings (▷ page 84)

### Steering wheel heating

#### Switching on/off

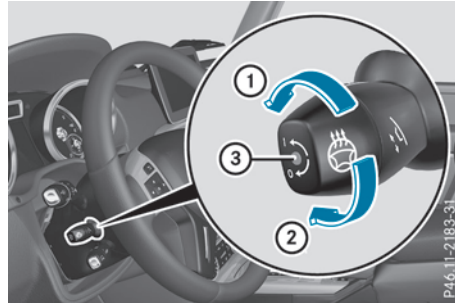

- ① To switch on the steering wheel heating
- ② To switch off the steering wheel heating
- ③ Indicator lamp

The steering wheel heating warms the leather areas on the steering wheel.

- ▶ **To switch on:** make sure that the SmartKey is in position **1** or **2** in the ignition lock.
- ▶ Turn the lever in the direction of arrow **①**. Indicator lamp **③** lights up.
- ▶ **To switch off:** make sure that the SmartKey is in position **1** or **2** in the ignition lock.
- ▶ Turn the lever in the direction of arrow **②**. Indicator lamp **③** goes out.

- i** The steering wheel heating does not switch off automatically.
- i** The steering wheel heating may switch off temporarily if:
  - the temperature in the vehicle interior is above 86 °F (30 °C)
  - the temperature of the steering wheel is above 95 °F (35 °C)
 Indicator lamp **③** remains on.
- i** The steering wheel heating is deactivated if you remove the SmartKey from the ignition lock.

## Problems with the steering wheel heating

If steering wheel heating indicator lamp ③ is flashing, the steering wheel heating has switched off automatically. The vehicle's electrical system voltage is too low because too many electrical consumers are switched on.

- ▶ Switch off electrical consumers that you do not need, such as the rear window defroster or interior lighting.  
Once the battery is sufficiently charged, the steering wheel heating will switch back on automatically.

### Steering wheel EASY-ENTRY/EXIT feature

#### Important safety notes

##### WARNING

When the EASY-ENTRY/EXIT feature adjusts the steering wheel and the driver's seat, you and other vehicle occupants – particularly children – could become trapped. There is a risk of injury.

While the EASY-ENTRY/EXIT feature is making adjustments, make sure that no one has any body parts in the sweep of the seat and the steering wheel.

If somebody becomes trapped:

- press one of the memory function position buttons, or
- press one of the memory function memory buttons, or
- move the switch for steering wheel adjustment in the opposite direction to that in which the steering wheel is moving

The adjustment process is stopped.

##### WARNING

If you drive off while the EASY-ENTRY/EXIT feature is making adjustments, you could lose control of the vehicle. There is a risk of an accident.

Always wait until the adjustment process is complete before driving off.

- ❗ Do not activate the EASY-ENTRY/EXIT feature, if the seat backrest is reclined too far backwards. This can damage the front or rear seats. You must first move the backrest to a vertical position.

The EASY-ENTRY/EXIT feature makes getting in and out of your vehicle easier.

You can activate and deactivate the EASY-ENTRY/EXIT feature in the on-board computer (> page 170).

### Position of the steering wheel when the EASY-ENTRY/EXIT feature is active

The steering wheel moves upwards and towards the dashboard if:

- you remove the SmartKey from the ignition lock or
- you open the driver's door and the SmartKey is in position **0** or **1** in the ignition lock

- ❗ The steering wheel only moves upwards and towards the dashboard if it has not already reached the upper steering limiter.

### Position of the steering wheel for driving

The steering wheel is moved to the last selected position when:

- the driver's door is closed
- you insert the SmartKey into the ignition lock

The last position of the steering column is stored when you switch off the ignition or when you store the setting with the memory function (> page 84).

## Mirrors

### Rear-view mirror

- ▶ Adjust the rear-view mirror in such a way that you have a good view of road and traffic conditions behind you.

## Exterior mirrors

### Adjusting the exterior mirrors

#### WARNING

The exterior mirror on the front-passenger side reduces the size of the image. Visible objects are actually closer than they appear. This means that you could misjudge the distance from road users traveling behind, e.g. when changing lane. There is a risk of an accident.

For this reason, always make sure of the actual distance from the road users traveling behind by glancing over your shoulder.



- ▶ Make sure that the SmartKey is in position 1 or 2 in the ignition lock (▷ page 105).
- ▶ Press button ① to select the left-hand exterior mirror

or

- ▶ Press button ② to select the right-hand exterior mirror.
- ▶ Press button ③ up, down, or to the left or right until you have adjusted the exterior mirror to the correct position. You should have a good overview of traffic conditions.

- i** The convex exterior mirrors provide a larger field of vision.
- i** The exterior mirrors are heated automatically if the rear window defroster is switched on and the outside temperature is low.

### Folding the exterior mirrors in/out electrically



- ▶ Make sure that the SmartKey is in position 1 or 2 in the ignition lock (▷ page 105).
- ▶ Briefly press ①. Both exterior mirrors fold in or out.
- i** Make sure that the exterior mirrors are always folded out fully while driving. They could otherwise vibrate.
- i** If you are driving faster than 9 mph (15 km/h), you can no longer fold in the exterior mirrors.

### Resetting the exterior mirrors



If the battery has been disconnected or completely discharged, the exterior mirrors must be reset. The exterior mirrors will otherwise not fold in when you select the "Fold in mirrors when locking" function in the on-board computer (▷ page 170).

- ▶ Make sure that the SmartKey is in position 1 in the ignition lock (▷ page 105).
- ▶ Briefly press ①.

### Folding the exterior mirrors in/out automatically

If the "Fold in mirrors when locking" function is activated in the on-board computer (> page 170):

- the exterior mirrors fold in automatically as soon as you lock the vehicle from the outside.
- the exterior mirrors fold out again automatically as soon as you unlock the vehicle and then open the driver's or front-passenger door.

### Exterior mirror pushed out of position

- ▶ Press button ① repeatedly until you hear the mirror engage in position. The mirror housing is engaged again and you can adjust the exterior mirrors as usual (> page 82).

### Automatic anti-glare mirrors

The rear-view mirror and the exterior mirror on the driver's side automatically go into anti-glare mode if:

- the ignition is switched on and
  - incident light from headlamps strikes the sensor in the rear-view mirror
- i** The mirrors do not go into anti-glare mode if reverse gear is engaged or if the interior lighting is switched on.

### Parking position for the exterior mirror on the front-passenger side

#### Setting/storing the parking position

##### Using reverse gear

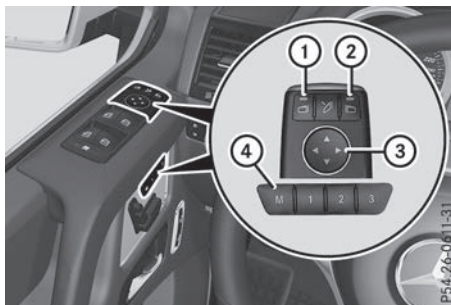

- ① Left-hand exterior mirror
- ② Right-hand exterior mirror
- ③ Adjustment button
- ④ Memory button

You can position the front-passenger side exterior mirror in such a way that you can see the rear wheel on that side as soon as you engage reverse gear. You can store this position.

- ▶ Make sure that the vehicle is stationary and that the SmartKey is in position 2 in the ignition lock (> page 105).
- ▶ Press button ② for the exterior mirror on the front-passenger side.
- ▶ Engage reverse gear. The exterior mirror on the front-passenger side moves to the preset parking position.
- ▶ Use adjustment button ③ to adjust the exterior mirror to a position that allows you to see the rear wheel and the curb. The parking position is stored.

- i** If you shift the transmission to another position, the exterior mirror on the front-passenger side returns to the driving position.

##### Using the memory button

You can position the front-passenger side exterior mirror in such a way that you can see the rear wheel on that side as soon as you engage reverse gear. This setting can be stored using memory button **M** ④.

- ▶ Make sure that the SmartKey is in position **2** in the ignition lock (▷ page 105).
- ▶ With the exterior mirror on the front-passenger side activated, use adjustment button **③** to adjust the exterior mirror. In the exterior mirror, the rear wheel and the curb should be visible.
- ▶ Press memory button **M** **④** and one of the arrows on adjustment button **③** within three seconds.  
The parking position is stored if the exterior mirror does not move.
- ▶ If the mirror moves out of position, repeat the steps.

### Calling up a stored parking position setting

- ▶ Turn the SmartKey to position **2** in the ignition lock (▷ page 105).
- ▶ Adjust the exterior mirror on the front-passenger side using button **②**.
- ▶ Engage reverse gear.  
The exterior mirror on the front-passenger side moves to the stored parking position.

The exterior mirror on the front-passenger side moves back to its original position:

- as soon as you exceed a speed of 9 mph (15 km/h)
- if you press button **①** for the exterior mirror on the driver's side

## Memory functions

### Storing settings

#### WARNING

If you use the memory function on the driver's side while driving, you could lose control of the vehicle as a result of the adjustments being made. There is a risk of an accident. Only use the memory function on the driver's side when the vehicle is stationary.

#### WARNING

When the memory function adjusts the seat or steering wheel, you and other vehicle occupants – particularly children – could become trapped. There is a risk of injury.

While the memory function is making adjustments, make sure that no one has any body parts in the sweep of the seat or steering wheel. If somebody becomes trapped, immediately release the memory function position button. The adjustment process is stopped.

#### WARNING

Children could become trapped if they activate the memory function, particularly when unattended. There is a risk of injury.

When leaving the vehicle, always take the SmartKey with you and lock the vehicle. Never leave children unsupervised in the vehicle.

The memory function can be used if the ignition is switched off.

With the memory function, you can store up to three different settings, e.g. for three different people.

The following settings are stored as a single memory preset:

- position of the seat, backrest and head restraint
- driver's side: steering wheel position
- driver's side: position of the exterior mirrors on the driver's and front-passenger sides



- ▶ Make sure that the SmartKey is in position **2** (▷ page 105) or that the respective door is open.
- ▶ Adjust the seat (▷ page 76) and head restraint (▷ page 76).
- ▶ On the driver's side, adjust the steering wheel (▷ page 80) and the exterior mirrors (▷ page 82).

- ▶ Press memory button **M**.
- ▶ Press one of memory buttons **1**, **2** or **3** within three seconds.  
The settings are stored in the selected storage position.

### Calling up a stored setting

- ❗ If you want to move the seat from the fully reclined position to a stored seat position, first raise the backrest using the seat switch. The seat could otherwise be damaged.
- ▶ Press and hold the relevant memory button **1**, **2** or **3**, until the seat, head restraints, steering wheel and mirrors are in the stored position.
- ❗ The setting procedure is interrupted as soon as you release the memory button.

## Exterior lighting

### General notes

USA only: if you wish to drive during the daytime without lights, switch off the **Daytime Running Lights** function via the on-board computer (▷ page 169).

### Light switch

#### Operation

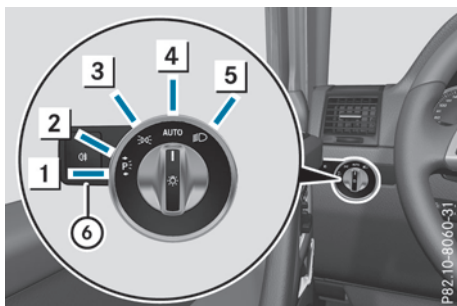

- 1 Left-hand standing lamps
- 2 Right-hand standing lamps
- 3 Parking lamps, side marker lamps, license plate and instrument cluster lighting
- 4 **AUTO** Automatic headlamp mode, controlled by the light sensor
- 5 Low-beam/high-beam headlamps
- 6 Rear fog lamp

If you hear a warning tone when you leave the vehicle, the lights may still be switched on.

- ▶ Turn the light switch to the **AUTO** position.

The exterior lighting, except the parking lamps/standing lamps, switches off automatically if you:

- remove the SmartKey from the ignition lock
- open the driver's door with the SmartKey in position **0**

### Low-beam headlamps

#### WARNING

When the light switch is set to **AUTO**, the low-beam headlamps may not be switched on automatically if there is fog, snow or other

causes of poor visibility due to the weather conditions such as spray. There is a risk of an accident.

In such situations, turn the light switch to



Even if the light sensor does not detect that it is dark, the parking lamps and low-beam headlamps switch on when the ignition is switched on and the light switch is set to the position. This is a particularly useful function in the event of rain and fog.

- ▶ **To switch on the low-beam headlamps:** turn the SmartKey to position **2** in the ignition lock or start the engine.
- ▶ Turn the light switch to the position. The green indicator lamp on the instrument cluster lights up.

### Daytime running lamps

#### Daytime running lamps in Canada

The daytime running lamps function is required by law in Canada. It cannot therefore be deactivated.

- ▶ Turn the light switch to the **AUTO** position. With the engine running: depending on the ambient light, the daytime running lamps or the low-beam headlamps are switched on. When the low-beam headlamps are switched on, the green indicator lamp in the instrument cluster lights up.

When the engine is running and the vehicle is stationary: if you shift the automatic transmission from a driving position to position **P**, the daytime running lamps or low-beam headlamps go out after three minutes.

When the engine is running, the vehicle is stationary and in bright ambient light: if you turn the light switch to the position, the daytime running lamps and parking lamps are switched on.



If the engine is running and you turn the light switch to the position, the manual settings take precedence over the daytime running lamps.

#### Daytime running lamps in the USA

In the USA, the daytime running lamps are deactivated upon delivery from the factory.



- ▶ **To switch on the daytime running lamps:** switch on the **Daytime Running Lights** function via the on-board computer (> page 169).
- ▶ Turn the light switch to the **AUTO** position. With the engine running: depending on the ambient light, the daytime running lamps or the low-beam headlamps are switched on. When the low-beam headlamps are switched on, the green  indicator lamp in the instrument cluster lights up.

If the engine is running and you turn the light switch to the  or  position, the manual settings take precedence over the daytime running lamps.

### Automatic headlamp mode

#### **WARNING**

When the light switch is set to **AUTO**, the low-beam headlamps may not be switched on automatically if there is fog, snow or other causes of poor visibility due to the weather conditions such as spray. There is a risk of an accident.

In such situations, turn the light switch to .

The automatic headlamp feature is only an aid. The driver is responsible for the vehicle's lighting at all times.

**AUTO** is the favored light switch setting.

The light setting is automatically selected according to the brightness of the ambient light, but not in the event of poor visibility due to weather conditions such as fog, snow or spray.



- ▶ **To switch on the automatic headlamps:** turn the light switch to the **AUTO** position. With the SmartKey in position **1** in the ignition lock, the parking lamps are switched on or off automatically depending on the brightness of the ambient light.

If you have switched on the **Daytime Running Lights** function via the on-board computer, the daytime running lamps or the parking lamps and low-beam headlamps will switch on or off automatically while the engine is running.



When the low-beam headlamps are switched on, the green  indicator lamp in the instrument cluster lights up.



### Rear fog lamp

The rear fog lamp improves visibility of your vehicle for the traffic behind in the event of thick fog. You must observe the legal requirements for the country in which you are currently driving when operating the rear fog lamp.

- ▶ **To switch on the rear fog lamp:** turn the SmartKey in the ignition lock to position **2** or start the engine.
- ▶ Turn the light switch to the  or **AUTO** position.
- ▶ Press the  button. The yellow  indicator lamp on the instrument cluster lights up.



### Parking lamps

- ▶ **If the battery charge is very low,** the parking lamps or standing lamps are automatically switched off to enable the next engine start. Always park your vehicle safely and in a well lit area, in accordance with the relevant legal stipulations. Avoid using the  parking lamps over a period of several hours. If possible, switch on the right-hand  or left-hand  standing lamps.

- ▶ **To switch on:** turn the light switch to the  position. The green  indicator lamp on the instrument cluster lights up.

### Standing lamps

Switching on the standing lamps ensures the corresponding side of the vehicle is illuminated.

- ▶ **To switch on the standing lamp:** turn the SmartKey to position **0** in the ignition lock or remove the SmartKey.
- ▶ Turn the light switch to the  (left-hand side of the vehicle) or  (right-hand side of the vehicle) position.

### Headlamp cleaning system



The headlamps are cleaned automatically if the "Wipe with washer fluid" function is operated ten times while the lights are on and the engine is running (> page 93). When you switch off

the ignition, the automatic headlamp cleaning system is reset and counting is resumed from 0.

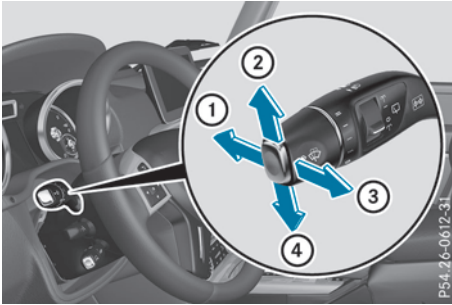
### Combination switch



- ① High-beam headlamps
- ② Turn signal, right
- ③ High-beam flasher
- ④ Turn signal, left

- ▶ **To indicate briefly:** press the combination switch briefly to the pressure point in the direction of arrow ② or ④. The corresponding turn signal flashes three times.
- ▶ **To indicate:** press the combination switch beyond the pressure point in the direction of arrow ② or ④.
- ▶ **To switch on the high-beam headlamps:** turn the light switch to the  or **AUTO** position.
- ▶ Press the combination switch beyond the pressure point in the direction of arrow ①. In the **AUTO** position, the high-beam headlamps are switched on only when it is dark and the engine is running. The blue  indicator lamp on the instrument cluster lights up when the high-beam headlamps are switched on.
- ▶ **To switch off the high-beam headlamps:** move the combination switch back to its normal position. The blue  indicator lamp on the instrument cluster goes out.
- ▶ **High-beam flasher:** pull the combination switch in the direction of arrow ③.

### Hazard warning lamps



- ▶ **To switch the hazard warning lamps on/off:** press button ①. The turn signal lamps flash when the hazard warning lamps are switched on. If you now switch on a turn signal lamp using the combination switch, only the turn signal lamp on the corresponding side of the vehicle will flash.

The hazard warning lamps automatically switch on if:

- an air bag is deployed or
- the Emergency Tensioning Devices are triggered, or
- the vehicle decelerates rapidly from a speed of above 45 mph (70 km/h) and comes to a standstill

The hazard warning lamps switch off automatically if the vehicle reaches a speed of above 6 mph (10 km/h) again after a full brake application.

The hazard warning lamps still operate if the ignition is switched off.

### Headlamps fogged up on the inside

Certain climatic and physical conditions may cause moisture to form in the headlamp. This moisture does not affect the functionality of the headlamp.

## Interior lighting

### Overview of interior lighting

#### Front overhead control panel

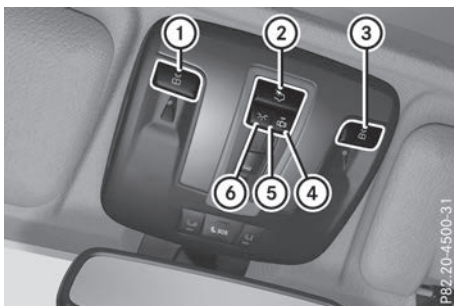

- ① Switches the left-hand front reading lamp on/off
- ② Switches the cargo compartment lamp/rear compartment lighting on/off
- ③ Switches the right-hand front reading lamp on/off
- ④ Switches the front interior lighting/automatic interior lighting control off
- ⑤ Switches the automatic interior lighting control on
- ⑥ Switches the front interior lighting on

#### Rear-compartment overhead control panel

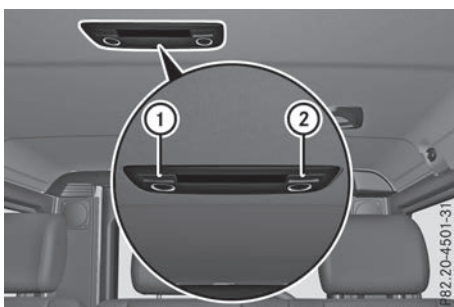

- ① Switches the right-hand reading lamp on/off
- ② Switches the left-hand reading lamp on/off

## Interior lighting control

### General notes

In order to prevent the vehicle's battery from discharging, the interior lighting functions are automatically deactivated after some time except for when the SmartKey is in position 2 in the ignition lock.

The brightness of the instrument cluster lighting may be set using the controller on the instrument cluster (▷ page 160).

### Automatic interior lighting control

► **To switch on:** move switch ⑤ to the center position (▷ page 89).

The interior lighting automatically switches on if you:

- unlock the vehicle
- open a door
- remove the SmartKey from the ignition lock

► **To switch off:** set switch ⑤ to the position. (▷ page 89).

The interior lighting remains switched off even if you:

- unlock the vehicle
- open a door
- remove the SmartKey from the ignition lock

The interior lighting is switched on for a set time when the SmartKey is removed from the ignition lock. You can activate this delayed switch-off using the on-board computer (▷ page 169).

When a front door is opened, the front interior lighting comes on. When a rear door is opened, the rear interior lights come on. In addition, the courtesy lights come on.

- i** If a door remains open and the SmartKey is not in the ignition lock, the interior lighting switches off after a short while.

Lights and windshield wipers

## Replacing bulbs

### Important safety notes

#### DANGER

Xenon bulbs carry a high voltage. You can get an electric shock if you remove the cover of

the Xenon bulb and touch the electrical contacts. There is a risk of fatal injury.

Never touch the parts or the electrical contacts of the Xenon bulb. Always have work on the Xenon bulbs carried out at a qualified specialist workshop.

#### WARNING

Bulbs, lamps and connectors can get very hot when operating. If you change a bulb, you could burn yourself on these components. There is a risk of injury.

Allow these components to cool down before changing a bulb.

Do not use a bulb if it has been dropped or if its glass tube has been scratched.

The bulb may explode if:

- you touch it
- it is hot
- you drop it
- you scratch it

Use bulbs only in closed lamps that have been designed for this purpose. Only install spare bulbs of the same type and the specified voltage.

Marks on the glass tube reduce the service life of the bulbs. Do not touch the glass tube with your bare hands. If necessary, clean the glass tube when cold with alcohol or spirit and rub it off with a lint-free cloth.

Protect bulbs from moisture during operation. Do not allow bulbs to come into contact with liquids.

**Xenon bulbs and LED modules:** in addition to the Xenon bulbs, there are LED modules which you cannot change yourself.

Have the following bulbs replaced at a qualified specialist workshop:

- High-mounted brake lamp
- Additional turn signals in the exterior mirrors
- Parking lamps/standing lamps (front)
- High-beam/low-beam headlamps (Xenon headlamps)
- Daytime running lamps
- License plate lamp
- Side marker lamps

- ① Individual segments of the license plate lamp LEDs may fail without a display message appearing in the multifunction display. Regularly check the license plate lamp. If necessary, visit a qualified specialist workshop.

You can replace the following bulbs:

- Turn signal lamp (front)
- Brake/tail lamp
- Turn signal lamp (rear)
- Tail lamps/standing lamps
- Backup lamp
- Rear fog lamp

Replace only the bulbs listed (▷ page 90). Have the bulbs that you cannot change yourself replaced at a qualified specialist workshop.

If you require assistance replacing bulbs, consult a qualified specialist workshop.

If the new bulb still does not light up, consult a qualified specialist workshop.

Headlamps and lights are an important aspect of vehicle safety. You must therefore make sure that these function correctly at all times. Have the headlamp setting checked regularly.

## Overview of bulb types

### Front bulbs

You can replace the following bulbs. The bulb type can be found in the legend.

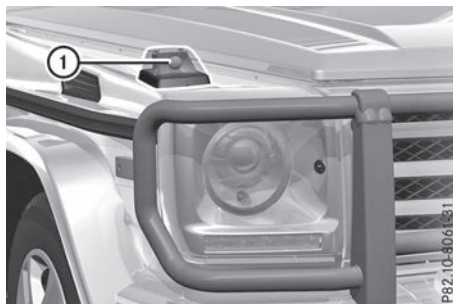

- ① Turn signal lamp: 1156 NA

### Rear bulbs

You can replace the following bulbs. The bulb type can be found in the legend.

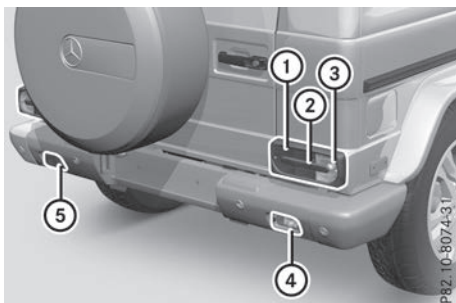

- ① Tail lamp/standing lamp: W 5 W
- ② Brake lamp/tail lamp: P 21/5 W
- ③ Turn signal lamp: PY 21 W
- ④ Backup lamp: P 21 W
- ⑤ Rear fog lamp: P 21 W

## Replacing front bulbs

### Turn signals

**!** Make sure that the protective grille does not hit any painted surfaces.

You could otherwise damage the paintwork.

**!** Do not fasten the screws too tightly. You could otherwise damage the lens.

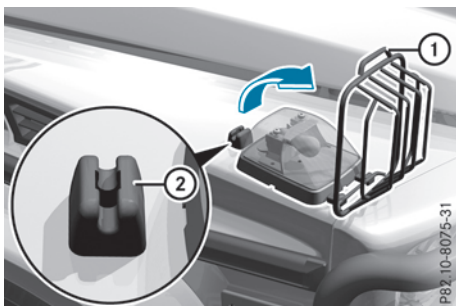

- ▶ Switch off the lights.
- ▶ **Mercedes-AMG vehicles:** pull protective grille ① out of mounting ② in the direction of the arrow and swing up.

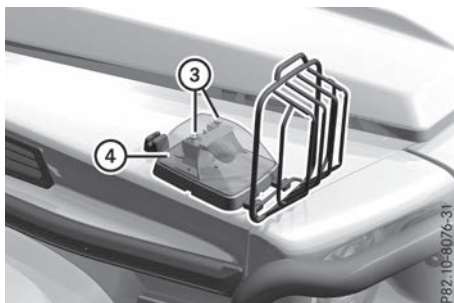

- ▶ Unscrew screws ③.
- ▶ Remove lens ④.

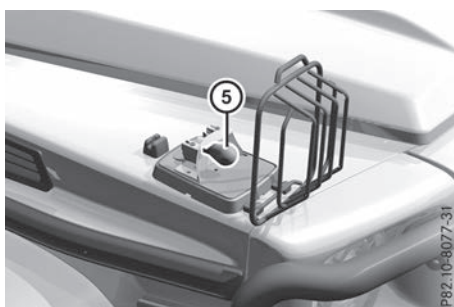

- ▶ Turn bulb ⑤ counter-clockwise, applying slight pressure, and pull it out of the bulb holder.
- ▶ Insert the new bulb into the bulb holder and, applying slight pressure, turn it clockwise until it engages.
- ▶ Install lens ④.
- ▶ Replace and tighten screws ③.
- ▶ **Mercedes-AMG vehicles:** fold down protective grille ① and engage it in mounting ②.

## Replacing rear bulbs

### Protective grille (Mercedes-AMG vehicles)

**!** Make sure that the protective grille does not hit any painted surfaces.

You could otherwise damage the paintwork.

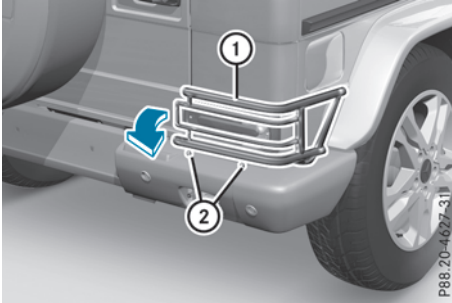

**Mercedes-AMG vehicles:** you must remove the protective grille before you can replace the bulbs in the tail lamps.

- ▶ Unscrew screws ②.
- ▶ Swing protective grille ① to the right.
- ▶ After you have replaced the bulbs, swing protective grille ① to the left.
- ▶ Replace and tighten screws ②.

### Tail lamps

⚠ When installing the lens, make sure that the seal is positioned correctly.

⚠ Do not fasten the screws too tightly. You could otherwise damage the lens.

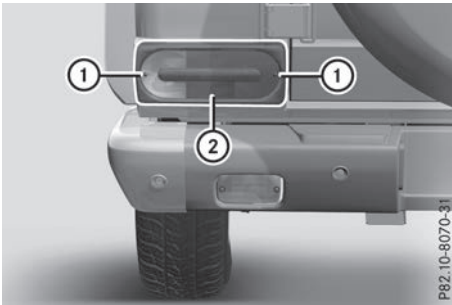

- ▶ Switch off the lights.
- ▶ Unscrew screws ①.
- ▶ Remove lens ②.

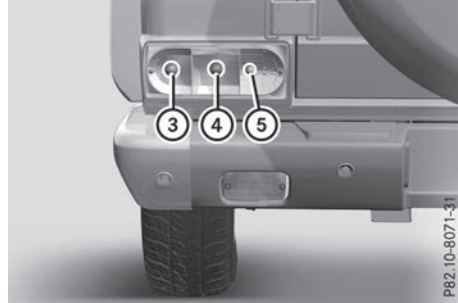

- ③ Turn signals
- ④ Brake/tail lamp
- ⑤ Tail lamps/standing lamps

- ▶ Turn the respective bulb counter-clockwise, applying slight pressure, and pull it out of the bulb holder.
- ▶ Insert the new bulb into the bulb holder and, applying slight pressure, turn it clockwise until it engages.

▶ Install lens ②.

▶ Tighten screws ①.

▶ **Mercedes-AMG vehicles:** secure the protective grille (▷ page 91).

### Backup lamp/rear fog lamp

⚠ Do not fasten the screws too tightly. You could otherwise damage the lens.

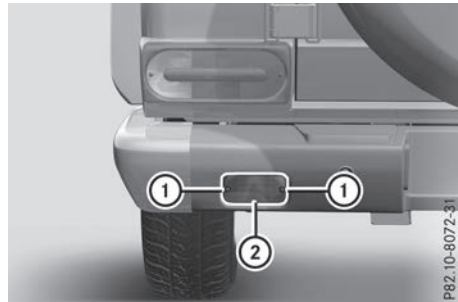

- ▶ Switch off the lights.
- ▶ Unscrew screws ①.
- ▶ Remove lens ②.

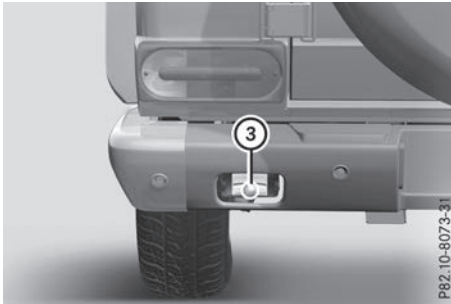

- ▶ Turn bulb ③ counter-clockwise, applying slight pressure, and pull it out of the bulb holder.
- ▶ Insert the new bulb into the bulb holder and, applying slight pressure, turn it clockwise until it engages.
- ▶ Install lens ②.
- ▶ Tighten screws ①.

## Windshield wipers

### Switching the windshield wipers on/off

**!** Do not operate the windshield wipers when the windshield is dry, as this could damage the wiper blades. Moreover, dust that has collected on the windshield/rear window can scratch the glass if wiping takes place when the windshield/rear window is dry.

If it is necessary to switch on the windshield wipers in dry weather conditions, always use washer fluid when operating the windshield wipers.

**!** If the windshield wipers leave smears on the windshield/rear window after the vehicle has been washed in an automatic car wash, this may be due to wax or other residue. Clean the windshield/rear window with washer fluid after an automatic car wash.

**!** Intermittent wiping with rain sensor: due to optical influences and the windshield becoming dirty in dry weather conditions, the windshield wipers may be activated inadvertently. This could then damage the windshield wiper blades or scratch the windshield.

For this reason, you should always switch off the windshield wipers in dry weather.

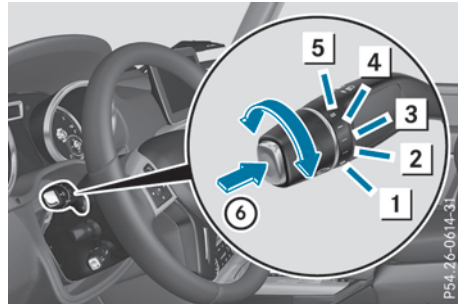

- |   |      |                             |
|---|------|-----------------------------|
| 1 | 0    | Windshield wipers off       |
| 2 | ...  | Intermittent wipe, normal   |
| 3 | .... | Intermittent wipe, frequent |
| 4 | —    | Continuous wipe, slow       |
| 5 | ==   | Continuous wipe, fast       |
| 6 |      | Single wipe                 |
|   |      | Wipes with washer fluid     |

- ▶ Switch on the ignition.
- ▶ Turn the combination switch to the corresponding position.

In the **...** or **....** position, the appropriate wiping frequency is set automatically according to the intensity of the rain. In the **....** position, the rain sensor is more sensitive than in the **...** position, causing the windshield wiper to wipe more frequently.

Intermittent wiping is interrupted if you stop the vehicle and open a front door. This protects people getting into and out of the vehicle from being sprayed with water.

Intermittent wiping continues when all doors are closed and:

- you shift the automatic transmission to drive position **D** or reverse gear **R** or
- you change the wiper setting on the combination switch

### Switching the rear window wiper on/off

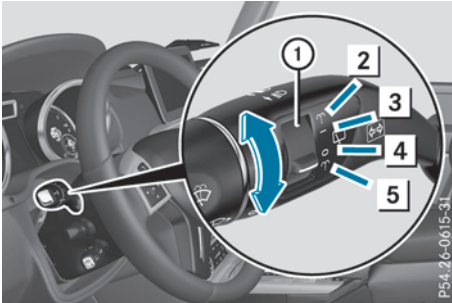

- ① Switch
- ② Wipes with washer fluid
- ③ Switches on intermittent wiping
- ④ Switches off intermittent wiping
- ⑤ Wipes with washer fluid

- ▶ Turn the SmartKey to position ① or ② in the ignition lock.
- ▶ Turn switch ① on the combination switch to the corresponding position.  
When the rear window wiper is switched on, the icon appears in the instrument cluster.

The rear window wiper comes on automatically if you shift the automatic transmission to position **R** while the windshield wipers are on.

### Replacing the wiper blades

#### Important safety notes

#### WARNING

If the windshield wipers begin to move while you are changing the wiper blades, you could be trapped by the wiper arm. There is a risk of injury.

Always switch off the windshield wipers and ignition before changing the wiper blades.

- ❗ To avoid damaging the wiper blades, make sure that you touch only the wiper arm of the wiper.
- ❗ Never open the hood if a windshield wiper arm has been folded away from the windshield.

Never fold a windshield wiper arm without a wiper blade back onto the windshield/rear window.

Hold the windshield wiper arm firmly when you change the wiper blade. If you release the windshield wiper arm without a wiper blade and it falls onto the windshield, the windshield may be damaged by the force of the impact. Mercedes-Benz recommends that you have the wiper blades changed at a qualified specialist workshop.

### Removing the wiper blades

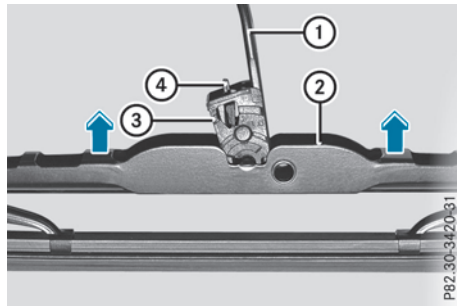

- ▶ Remove the SmartKey from the ignition lock.
- ▶ Fold wiper arm ① away from the windshield until it engages.
- ▶ Position wiper blade ② horizontally.
- ▶ Press locking spring ④.
- ▶ Slide wiper blade ② with hinge piece ③ from wiper arm ①.

### Installing the wiper blade

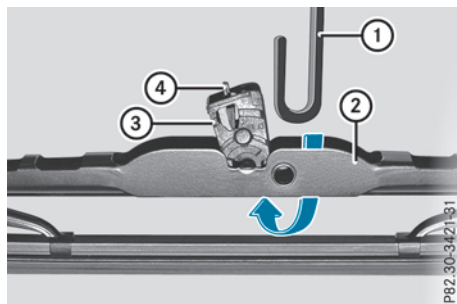

- ▶ Slide wiper arm ① into new wiper blade ② with hinge piece ③.
- ▶ Engage spring clip ④ into the end of the wiper arm.



- ▶ Make sure that wiper blade ② is seated correctly.
- ▶ Fold wiper arm ① back onto the windshield.

### Problems with the windshield wipers

Problem	Possible causes/consequences and ▶ Solutions
The windshield wipers are jammed.	Leaves or snow, for example, are obstructing windshield wiper movement. The wiper motor has been deactivated. <ul style="list-style-type: none"> <li>▶ Switch off the engine.</li> <li>▶ Remove the SmartKey from the ignition lock.</li> <li>▶ Remove the cause of the obstruction.</li> <li>▶ Switch the windshield wipers back on.</li> </ul>
The windshield wipers fail completely.	The windshield wiper drive is malfunctioning. <ul style="list-style-type: none"> <li>▶ Select another wiper speed on the combination switch.</li> <li>▶ Have the windshield wipers checked at a qualified specialist workshop.</li> </ul>
The windshield washer fluid from the spray nozzles no longer hits the center of the windshield.	The spray nozzles are misaligned. <ul style="list-style-type: none"> <li>▶ Have the spray nozzles adjusted at a qualified specialist workshop.</li> </ul>

## Overview of the climate control system

### General notes

Observe the settings recommended on the following pages. The windows could otherwise fog up.

To prevent the windows from fogging up:

- switch off climate control only briefly
- switch on air-recirculation mode only briefly
- switch on the cooling with air dehumidification function
- activate the "Windshield defrosting" function briefly, if required

Climate control regulates the temperature and the humidity in the vehicle interior and filters undesirable substances out of the air.

The "Cooling with air dehumidification" function is only available when the engine is running. Optimum operation is only achieved when the side windows and the sliding sunroof are closed.

The climatic comfort deteriorates whilst the sliding sunroof is open. Set the temperature manually if the sliding sunroof is open.

The residual heat function can only be activated or deactivated with the ignition switched off (> page 102).

The integrated filter can filter out most particles of dust and completely filters out pollen. A clogged filter reduces the amount of air supplied to the vehicle interior. Depending on the operating conditions and environmental influences, the interval for replacing the filter may be shorter than specified.

- i** Ventilate the vehicle for a brief period during warm weather, e.g. using the convenience opening feature (> page 70). This will speed up the cooling process and the desired vehicle interior temperature will be reached more quickly.

### Control panel for dual-zone automatic climate control

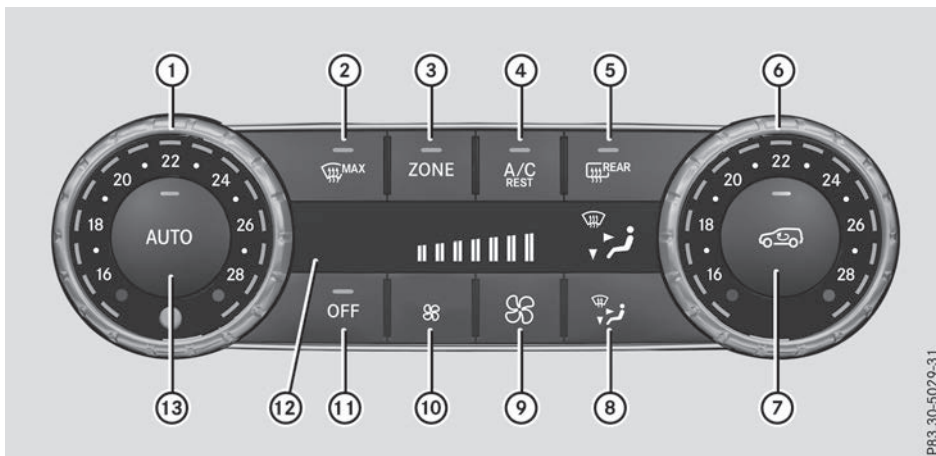

Control panel (Canada only)

- ① Sets the temperature, left (> page 99)
- ② Defrosts the windshield (> page 100)
- ③ Switches the ZONE function on/off (> page 100)
- ④ Switches cooling with air dehumidification on/off (> page 98)  
Switches the residual heat on/off (> page 102)
- ⑤ Switches the rear window defroster on/off (> page 101)
- ⑥ Sets the temperature, right (> page 99)

- ⑦ Activates/deactivates air-recirculation mode (▷ page 102)
- ⑧ Sets the air distribution (▷ page 99)
- ⑨ Increases the airflow (▷ page 99)
- ⑩ Reduces the airflow (▷ page 99)
- ⑪ Switches the climate control on/off (▷ page 98)
- ⑫ Display
- ⑬ Sets climate control to automatic (▷ page 99)

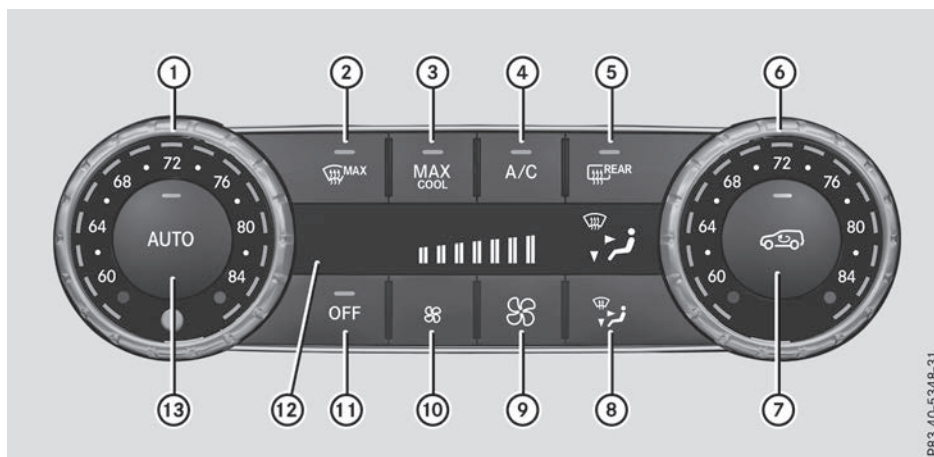

Control panel (USA only)

- ① Sets the temperature, left (▷ page 99)
- ② Defrosts the windshield (▷ page 100)
- ③ Switches the maximum cooling MAX COOL on/off (▷ page 100)
- ④ Switches cooling with air dehumidification on/off (▷ page 98)
- ⑤ Switches the rear window defroster on/off (▷ page 101)
- ⑥ Sets the temperature, right (▷ page 99)
- ⑦ Activates/deactivates air-recirculation mode (▷ page 102)
- ⑧ Sets the air distribution (▷ page 99)
- ⑨ Increases the airflow (▷ page 99)
- ⑩ Reduces the airflow (▷ page 99)
- ⑪ Switches the climate control on/off (▷ page 98)
- ⑫ Display
- ⑬ Sets climate control to automatic (▷ page 99)

### Optimum use of dual-zone climate control

### Optimum use of the automatic climate control

The following contains notes and recommendations on optimum use of dual-zone climate control.

- You can switch on climate control by using the **AUTO** and **A/C** or **AUTO** and **A/C** buttons. The indicator lamps in the **AUTO** and **A/C** or **AUTO** and **A/C** buttons light up.
- Set the temperature to 72 °F (22 °C).
- Only use the "Windshield defrosting" function briefly until the windshield is clear again.
- Only use air-recirculation mode briefly, e.g. if there are unpleasant outside odors or when in a tunnel. The windows could otherwise fog up,

since no fresh air is drawn into the vehicle in air-recirculation mode.

### ECO start/stop function

During automatic engine switch-off, the climate control system only operates at a reduced capacity. If you require the full climate control output, you can switch off the ECO start/stop function by pressing the ECO button (▷ page 108).

## Operating the climate control system

### Activating/deactivating climate control

#### General notes

When the climate control is switched off, the air supply and air circulation are also switched off.

## Switching cooling with air dehumidification on/off

#### General notes

If you deactivate the "Cooling with air-dehumidification" function, the air inside the vehicle will not be cooled. The air inside the vehicle will also not be dehumidified. The windows can fog up more quickly. Therefore, only deactivate the "Cooling with air-dehumidification" function briefly.



The "Cooling with air dehumidification" function is only available when the engine is running.



The air inside the vehicle is cooled and dehumidified according to the temperature selected.



Condensation may drip from the underside of the vehicle when it is in cooling mode. This is normal and not a sign that there is a malfunction.

#### Activating/deactivating

► **To activate:** press the  or  button.

The indicator lamp in the  or  button lights up.

► **To deactivate:** press the  or  button.

The indicator lamp in the  or  button goes out. The "Cooling with air dehumidification" function has a delayed switch-off feature.

#### Problems with the "Cooling with air dehumidification" function

❗ If the cooling with air dehumidification does not switch on, it is possible that the climate control system has lost coolant.

Have the cooling with air dehumidification checked at a qualified specialist workshop.

The windows could fog up. Therefore, switch off climate control only briefly.

Activate climate control primarily using the  button (▷ page 99).

#### Activating/deactivating



► Turn the SmartKey to position  in the ignition lock (▷ page 105).

► **To activate:** press the  button.

The indicator lamp in the  button lights up. Airflow and air distribution are set to automatic mode.

► **To deactivate:** press the  button.

The indicator lamp in the  button lights up.









Problem	Possible causes/consequences and ► Solutions
The indicator lamp in the  or  button flashes three times or remains off. The "Cooling with air dehumidification" function cannot be switched on.	Cooling with air dehumidification has been deactivated due to a malfunction. ► Visit a qualified specialist workshop.

## Setting climate control to automatic



### General notes

In automatic mode, the set temperature is maintained at a constant level. The system automatically regulates the temperature of the dispersed air, the airflow and the air distribution. Automatic mode works best when cooling with air dehumidification is also activated. If necessary, cooling with air dehumidification can be deactivated.

### Automatic control







- Turn the SmartKey to position  in the ignition lock (► page 105).
  - Set the desired temperature.
  - **To activate:** press the  button.  
The indicator lamp in the  button lights up. Automatic air distribution and airflow are activated.
  - **To deactivate:** press the  button.
- or
- Press the  or  button.  
The indicator lamp in the  button goes out.
  - **To switch to manual mode:** press the  button.

## Setting the temperature



- Different temperatures can be set for the driver's and front-passenger sides.
- Turn the SmartKey to position  in the ignition lock (► page 105).
  - Adjust control  or  (► page 96) to the desired temperature.  
Only change the temperature setting in small increments. Start at 72 °F (22 °C).

## Setting the air distribution



### Air distribution settings

-  Directs air through the center and side air vents
-  Directs air through the footwell air vents
-  Directs air through the center, side and footwell vents
-  Directs air through the defroster vents
-  **Canada only:** directs the airflow through the defroster, center and side air vents.
-  Directs air through the defroster and footwell vents
-  **Canada only:** directs the airflow through the defroster, center and footwell air vents.

### Setting





- Turn the SmartKey to position  in the ignition lock (► page 105).
- Press the  button repeatedly until the desired symbol appears in the display.

## Setting the airflow

- Turn the SmartKey to position  in the ignition lock (► page 105).
- **To increase:** press the  button.
- **To reduce:** press the  button.

 The airflow from the rear-compartment vents and the center vents is the same.

### Switching the ZONE function on/off

- ▶ **To switch on:** press the  button.  
The indicator lamp in the  button lights up.  
The temperature setting for the driver's side is not adopted for the front-passenger side and the rear compartment. The temperature for the front-passenger side and the rear compartment is set separately.
- ▶ **To switch off:** press the  button.  
The indicator lamp in the  button goes out.  
The temperature setting for the driver's side is adopted for the front-passenger side and the rear compartment.





### Defrosting the windshield

#### General notes

You can use this function to defrost the windshield or to defrost the inside of the windshield and the side windows.

Switch off the "Windshield defrosting" function as soon as the windshield is clear again.



#### Activating/deactivating

- ▶ Turn the SmartKey to position  in the ignition lock (▷ page 105).
- ▶ **To activate:** press the  button.  
The indicator lamp in the  button lights up.  
The climate control system switches to the following functions:
  - cooling with air dehumidification on
  - high airflow
  - high temperature
  - air distribution to the windshield and front side windows
  - air-recirculation mode off
- ▶ **To deactivate:** press the  button.  
The indicator lamp in the  button goes out. The previously selected settings are restored. The cooling with air dehumidification function remains on. Air-recirculation mode remains deactivated.

### Activating/deactivating MAX COOL maximum cooling

The MAX COOL function is only available in vehicles for the USA.

MAX COOL is only operational when the engine is running.



- ▶ **To activate:** press the  button.  
The indicator lamp in the button lights up.
- ▶ **To deactivate:** press the  button.  
The indicator lamp in the  button goes out. The previously selected settings are restored.

When you activate MAX COOL, the following functions are also switched on:

- maximum cooling
- maximum airflow
- air-recirculation mode



### Defrosting the windows

#### Windows fogged up on the inside

- ▶ Activate the  cooling with air dehumidification function.
- ▶ Activate the  automatic mode.
- ▶ If the windows continue to fog up, activate the "Windshield defrosting" function (▷ page 100).

**i** You should only select this setting until the windshield is clear again.

#### Windows fogged up on the outside

- ▶ Switch on the windshield wipers (▷ page 93).
- ▶ Press the  button repeatedly until the  or  symbol appears in the display.

**i** You should only select this setting until the windshield is clear again.

**i** If you clean the windows regularly, they do not fog up so quickly.

## Activating/deactivating windshield heating



- ▶ Turn the SmartKey to position **2** (> page 105) in the ignition lock .
- ▶ **To activate:** press button **2**. Indicator lamp **1** lights up.
- ▶ **To deactivate:** press button **2**. Indicator lamp **1** goes out.

At outside temperatures above 50 °F (10 °C) the windshield heating cannot be switched on. Indicator lamp **1** lights up briefly when you attempt to activate it and then goes out again.

The windshield defroster has a high current draw. You should therefore switch it off as soon as the windshield is clear. Otherwise, the windshield heating switches off automatically after ten minutes.

When the windshield heating is switched on for the fourth time in a row, windshield heating switches off automatically after five minutes.

Indicator lamp **1** flashes if too many electrical consumers are switched on at the same time when the battery voltage is low. After approximately 30 seconds the windshield heating switches off automatically.



## Switching the rear window defroster on/off

### General notes

The rear window defroster has a high current draw. You should therefore switch it off as soon as the rear window is clear. Otherwise, the rear window defroster switches off automatically after several minutes.

If the battery voltage is too low, the rear window defroster may switch off.

### Activating/deactivating

- ▶ Turn the SmartKey to position **2** in the ignition lock (> page 105).
- ▶ Press the  button. The indicator lamp in the  button lights up or goes out.

### Problems with the rear window defroster

Problem	Possible causes/consequences and ▶ Solutions
The indicator lamp in the  button flashes.	The on-board voltage is too low. ▶ Switch off any consumers that are not required, e.g. reading lamps, interior lighting or the seat heating.
The rear window defroster has deactivated prematurely or cannot be activated.	The battery has not been sufficiently charged. ▶ Switch off any consumers that are not required, e.g. reading lamps, interior lighting or the seat heating.



### Switching air-recirculation mode on/off

#### General notes



If you switch on air-recirculation mode, the windows can fog up more quickly, in particular at low temperatures. Only use air-recirculation mode briefly to prevent the windows from fogging up.

#### Activating/deactivating

► Turn the SmartKey to position **2** in the ignition lock (► page 105).

► **To activate:** press the  button. The indicator lamp in the  button lights up.

**i** Air-recirculation mode is automatically activated at high levels of pollution or at high outside temperatures. When air-recirculation mode is activated automatically, the indicator lamp in the  button is not lit. Outside air is added after about 30 minutes.

► **To deactivate:** press the  button. The indicator lamp in the  button goes out.

**i** Air-recirculation mode switches off automatically:

- after approximately five minutes at outside temperatures below approximately 41 °F
- after approximately five minutes if cooling with air dehumidification is deactivated
- after approximately 30 minutes at outside temperatures above approximately 41 °F (5 °C)

### Switching the residual heat on or off



#### General notes

The residual heat function is only available on vehicles for Canada.

It is possible to make use of the residual heat of the engine to continue heating the stationary vehicle for up to 30 minutes after the engine has been switched off. The heating time depends on the set interior temperature.



### Activating/deactivating

► Turn the SmartKey to position **0** in the ignition lock (► page 105) or remove it.

► **To activate:** press the  button. The indicator lamp in the  button lights up.

**i** The blower will run at a low speed regardless of the airflow setting.

**i** If you activate the residual heat function at high temperatures, only the ventilation will be activated.

► **To deactivate:** press the  button. The indicator lamp in the  button goes out.

Residual heat is deactivated automatically:

- after approximately 30 minutes
- when the ignition is switched on
- if the battery voltage drops
- if the coolant temperature is too low

### Air vents

#### Important safety notes

##### WARNING

Very hot or very cold air can flow from the air vents. This could result in burns or frostbite in the immediate vicinity of the air vents. There is a risk of injury.

Make sure that all vehicle occupants always maintain a sufficient distance to the air outlets. If necessary, redirect the airflow to another area of the vehicle interior.

In order to ensure the direct flow of fresh air through the air vents into the vehicle interior, please observe the following notes:

- keep the air inlet between the windshield and the hood free of blockages, such as ice, snow or leaves.
- never cover the air vents or air intake grilles in the vehicle interior.
- i** For virtually draft-free ventilation, adjust the sliders of the air vents to the center position.
- i** If the automatic climate control constantly differs from the set temperature or if unde-



sired drafts are noticeable, proceed as follows:

- ▶ Open the side air vents
- ▶ Open the center air vents
- ▶ Open the rear air vents
- ▶ Set the temperature to 72 °F (22 °C).  
The automatic climate control adjusts to the set temperature.

### Setting the air vents

Air vents are located:

- on the left and right-hand side of the dashboard
- in the middle of the dashboard
- in the rear-compartment center console

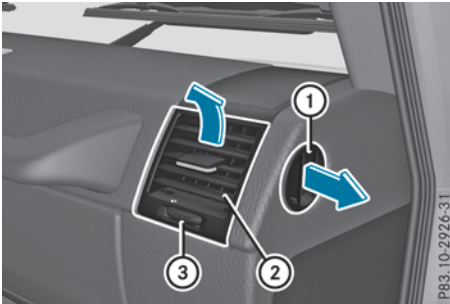

Side air vents

- ① Side window defroster vent
  - ② Adjustable side air vent
  - ③ Thumbwheel for side air vent
- ▶ **To open or close:** turn control ③ to the left or right.

Adjusting the rear air vents (see the Digital Operator's Manual).

### Notes on breaking-in a new vehicle

#### Important safety notes

The sensor system of some driving and driving safety systems adjusts automatically while a certain distance is being driven after the vehicle has been delivered or after repairs. Full system effectiveness is not reached until the end of this teach-in procedure.

New and replaced brake pads and discs only reach their optimum braking effect after several hundred kilometers of driving. Compensate for this by applying greater force to the brake pedal.

#### The first 1000 miles (1500 km)

The more you look after the engine when it is new, the more satisfied you will be with its performance in the future.

- You should therefore drive at varying vehicle and engine speeds for the first 1,000 miles (1,500 km).
- Avoid heavy loads, e.g. driving at full throttle, during this period.
- When shifting gears manually, shift up in good time, before the tachometer needle reaches  $\frac{2}{3}$  of the way to the red area of the tachometer display.
- Do not manually shift to a lower gear to brake the vehicle.
- Try to avoid depressing the accelerator pedal beyond the pressure point (kickdown).

Additional breaking-in notes for Mercedes-AMG vehicles:

- Do not drive faster than 85 mph (140 km/h) for the first 1,000 miles (1,500 km).
- Only briefly allow the engine to reach a maximum engine speed of 4,500 rpm.
- Avoid driving off-road before the first differential oil change at 2,000 miles (3,000 km).
- Ideally, for the first 1,000 miles (1,500 km), drive in program **C**.

After 1,000 miles (1,500 km), you can increase the engine speed gradually and bring the vehicle to full speed.

You should also observe these notes on breaking in if the engine or parts of the drive train on your vehicle have been replaced.

Always observe the maximum permissible speed.

### Axle differential transmission (Mercedes-AMG vehicles)

Change the oil after a breaking-in period of 2,000 miles (3,000 km) to improve protection of the axle differential transmission.

This oil change prolongs the service life of the axle differential transmission. Have the oil change carried out at a qualified specialist workshop.

### Axle differential transmission and portal transmission (G 500 4x4<sup>2</sup>)

Change the oil after a breaking-in period of 2,000 miles (3,000 km) to improve protection of the axle differential transmission and portal transmission.

This oil change prolongs the service life of the axle differential and portal transmission. Have the oil change carried out at a qualified specialist workshop.

## Driving

### Important safety notes

#### WARNING

Objects in the driver's footwell may restrict the clearance around the pedals or block a depressed pedal. This jeopardizes the operating and road safety of the vehicle. There is a risk of an accident.

Stow all objects securely in the vehicle so that they do not get into the driver's footwell.

When using floor mats or carpets, make sure that they are properly secured so that they do not slip or obstruct the pedals. Do not place several floor mats or carpets on top of one another.

#### WARNING

Unsuitable footwear can hinder correct usage of the pedals, e.g.:

- shoes with thick soles
- shoes with high heels
- slippers

There is a risk of an accident.

Wear suitable footwear to ensure correct usage of the pedals.

### WARNING

If you switch off the ignition while driving, safety-relevant functions are only available with limitations, or not at all. This could affect, for example, the power steering and the brake boosting effect. You will require considerably more effort to steer and brake. There is a risk of an accident.

Do not switch off the ignition while driving.

### WARNING

If the parking brake has not been fully released when driving, the parking brake can:

- overheat and cause a fire
- lose its hold function.

There is a risk of fire and an accident. Release the parking brake fully before driving off.

**!** Warm up the engine quickly. Do not use the engine's full performance until it has reached operating temperature.

Only shift the automatic transmission to the desired drive position when the vehicle is stationary.

Where possible, avoid spinning the drive wheels when pulling away on slippery roads. You could otherwise damage the drive train.

**!** Avoid high engine speeds when the engine is cold. The engine's service life could otherwise be significantly shortened. Do not use the engine's full performance until it has reached operating temperature.

**!** **Mercedes-AMG vehicles:** at low engine oil temperatures below 68 °F (+20 °C), the maximum engine speed is restricted in order to protect the engine. To protect the engine and maintain smooth engine operation, avoid driving at full throttle when the engine is cold.

### Key positions

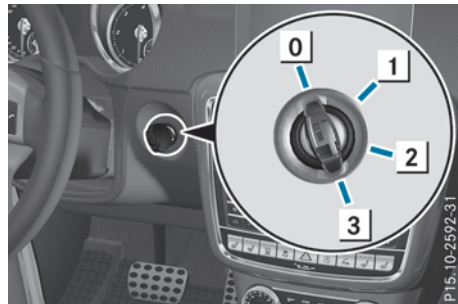

- 0** To remove the SmartKey
- 1** Power supply for some consumers, such as the windshield wipers
- 2** Ignition (power supply for all consumers) and drive position
- 3** To start the engine

As soon as the ignition is switched on, all the indicator lamps in the instrument cluster light up. If an indicator lamp does not go out after starting the engine or lights up while driving, see (▷ page 193).

If the SmartKey is in position **0** in the ignition lock for a longer period, it can no longer be turned in the ignition lock. The steering is then locked. To unlock, remove the SmartKey and reinsert it into the ignition lock.

The steering is locked when you remove the SmartKey from the ignition lock.

- ▶ Remove the SmartKey when the engine is switched off. The starter battery could otherwise be discharged.

If you cannot turn the SmartKey in the ignition lock, the starter battery may not be charged sufficiently.

- ▶ Check the starter battery and charge it if necessary (▷ page 248).

or

- ▶ Jump-start the vehicle (▷ page 249).

You can only remove the SmartKey if:

- the SmartKey is in position **0** in the ignition lock
- the automatic transmission selector lever is in **P**

## Starting the engine

### Important safety notes

#### WARNING

If children are left unsupervised in the vehicle, they could:

- open the doors, thus endangering other people or road users.
- get out and disrupt traffic.
- operate the vehicle's equipment.

Additionally, children could set the vehicle in motion if, for example, they:

- release the parking brake.
- shifting the automatic transmission out of park position **P**
- Start the engine.

There is a risk of an accident and injury.

When leaving the vehicle, always take the SmartKey with you and lock the vehicle. Never leave children or animals unattended in the vehicle. Always keep the SmartKey out of reach of children.

#### WARNING

Combustion engines emit poisonous exhaust gases such as carbon monoxide. Inhaling these exhaust gases leads to poisoning. There is a risk of fatal injury. Therefore never leave the engine running in enclosed spaces without sufficient ventilation.

#### WARNING

Flammable materials introduced through environmental influence or by animals can ignite if in contact with the exhaust system or parts of the engine that heat up. There is a risk of fire.

Carry out regular checks to make sure that there are no flammable foreign materials in the engine compartment or in the exhaust system.

-  Do not depress the accelerator when starting the engine.

## Starting procedure

- ▶ Shift the automatic transmission to position **P**.
- ▶ Make sure that the parking brake is applied.
- ▶ Turn the SmartKey to position **3** in the ignition lock (▷ page 105) and release it as soon as the engine is running.

You can also use the touch-start function. To do this, turn the SmartKey to position **3** (▷ page 105) and release it immediately. The engine then starts automatically.



## Pulling away

### General notes

#### WARNING

If the engine speed is above the idling speed and you engage transmission position **D** or **R**, the vehicle could pull away suddenly. There is a risk of an accident.

When engaging transmission position **D** or **R**, always firmly depress the brake pedal and do not simultaneously accelerate.

-  Do not depress the accelerator pedal while depressing the brake pedal. This impairs engine performance and results in premature wear on the brake system and drivetrain.
-  If a warning tone sounds and the **Release Park . Brake** message appears in the multi-function display, the parking brake is still applied. Release the parking brake.

Depress the accelerator carefully when pulling away.

The vehicle locks centrally once you have pulled away. The locking knobs in the doors drop down. You can open the doors from the inside at any time.

You can also deactivate the automatic locking feature (▷ page 170).

It is possible to shift the transmission from position **P** to the desired position only if you depress the brake pedal. Only then is the selector lever lock released.

-  Upshifts take place at higher engine speeds after a cold start. This helps the catalytic con-

verter to reach its operating temperature more quickly.

### Pulling away with a trailer

To ensure that you do not roll back when pulling away on an uphill slope, apply the parking brake.

- ▶ Depress the brake pedal and keep it depressed.
- ▶ Shift the automatic transmission to position **D** or **R**.

**i** Always wait until the shifting process is complete before driving off.

- ▶ Release the parking brake (> page 123).
- ▶ Release the brake pedal.
- ▶ Carefully depress the accelerator pedal.

### Hill start assist

Hill start assist helps you when pulling away forward or in reverse on an uphill gradient. It holds the vehicle for a short time after you have removed your foot from the brake pedal. This gives you enough time to move your foot from the brake pedal to the accelerator pedal and to depress it before the vehicle begins to roll.

#### **WARNING**

After a short time, hill start assist will no longer brake your vehicle and it could roll away. There is a risk of an accident and injury.

Therefore, quickly move your foot from the brake pedal to the accelerator pedal. Never leave the vehicle when it is held by hill start assist.

Hill start assist will not function if:

- you are pulling away on a level road or on a downhill gradient
- the transmission is in position **N**
- the parking brake is applied
- ESP® is malfunctioning

### ECO start/stop function

#### Important safety notes

#### **WARNING**

If the engine is switched off automatically and you exit the vehicle, the engine is restarted automatically. The vehicle may begin moving. There is a risk of accident and injury.

If you wish to exit the vehicle, always turn off the ignition and secure the vehicle against rolling away.

#### General notes

The ECO start/stop function switches the engine off automatically when the vehicle stops moving.

The engine starts automatically when the driver wants to pull away again. The ECO start/stop function thereby helps you to reduce the fuel consumption and emissions of your vehicle.

The ECO start/stop function is activated each time the engine is switched on or when you switch the drive program (except Mercedes-AMG vehicles).

**Mercedes-AMG vehicles:** the ECO start/stop function is activated after the engine is restarted and is only available in drive program **C**. When drive program **S** or **M** is selected, the ECO start/stop function is deactivated.

The system is operational if all conditions for automatic engine switch-off have been fulfilled (> page 108) and the  symbol is shown in green in the multifunction display.

If not all conditions for automatic engine switch-off are fulfilled (> page 108), the  ECO symbol is shown in yellow in the multifunction display.

If the ECO start/stop function has been manually deactivated (> page 108) or a malfunction has caused the system to be deactivated, the  ECO symbol is not displayed.

### Deactivating/activating the ECO start/stop function





- ▶ **To activate:** press button ①. Indicator lamp ② on button ① and the  ECO symbol in the multifunction display go out.

Selecting drive program **S** or **M** in Mercedes-AMG vehicles automatically deactivates the ECO start/stop function.

- ▶ **To activate:** press button ①. Indicator lamp ② lights up.

**Mercedes-AMG vehicles:** if drive program **S** or **M** is active, the automatic transmission switches to drive program **C**.

If all conditions for automatic engine switch-off (▷ page 108) are fulfilled, the  symbol is shown in green in the multifunction display.

If the conditions for automatic engine switch-off are not all fulfilled (▷ page 108), the  ECO symbol is lit yellow. If this is the case, the ECO start/stop function is not available.

- ❗ If indicator lamp ② is off, the ECO start/stop function has been deactivated manually or as the result of a malfunction. The engine will then not be switched off automatically when the vehicle stops.

### Automatic engine switch-off

If the vehicle is braked to a standstill with the transmission in **D** or **N**, the ECO start/stop function switches off the engine automatically.

The ECO start/stop function is operational and the  ECO symbol is shown in green in the multifunction display, if:

- the indicator lamp in the  ECO button is lit green
- the transfer case is in the **HIGH RANGE** on-road position
- the vehicle is stationary
- the outside temperature and the atmospheric air pressure is within the range that is suitable for the system
- the engine is at normal operating temperature
- the set temperature for the vehicle interior has been reached
- the battery is sufficiently charged
- the system detects that the windshield is not fogged up when the air-conditioning system is switched on
- the hood is closed
- the driver's door is closed and the driver's seat belt is fastened

If the conditions for automatic engine switch-off are not all fulfilled, the  ECO symbol is shown in yellow.

- ❗ If you shift the transmission from **R** to **D**, the ECO start/stop function is available again once the  ECO symbol reappears in green in the multifunction display.

- ❗ The engine can be automatically switched off an unlimited number of times.

- ❗ You can still activate the HOLD function when the vehicle is stationary, even if the engine has been switched off automatically. It is then not necessary to continue applying the brakes during the automatic stop phase. When you depress the accelerator pedal, the engine starts automatically and the braking effect of the HOLD function is deactivated. Depress the accelerator pedal carefully, as the engine must be started first.

- ❗ During automatic engine switch-off, the climate control system only operates at a reduced capacity. If you require full climate control capacity, the ECO start/stop function can be deactivated by pressing the ECO button (▷ page 108).

## Automatic engine start

The engine starts automatically if:

- In general:
  - you switch off the ECO start/stop function by pressing the ECO button
  - you release the brakes when in transmission position **D** or **N**, when the HOLD function is inactive
- By the driver:
  - you release the brakes when in transmission position **D** or **N**
  - you depress the accelerator pedal
  - you engage reverse gear **R**
  - you move the transmission out of position **P**
  - you switch to drive program **S** or **M** (Mercedes-AMG vehicles)
  - you unfasten your seat belt or open the driver's door
- By the system:
  - the vehicle starts to roll
  - the brake system requires this
  - the temperature in the vehicle interior deviates from the set range
  - the system detects moisture on the windshield when the air-conditioning system is switched on
  - the condition of charge of the battery is too low

**i** Shifting the transmission to position **P** does not start the engine.

## Problems with the engine

Problem	Possible causes/consequences and ► Solutions
The engine does not start. The starter motor can be heard.	<ul style="list-style-type: none"> <li>• There is a malfunction in the engine electronics.</li> <li>• There is a malfunction in the fuel supply.</li> </ul> <p>► Turn the SmartKey back to position <b>0</b> in the ignition lock before attempting to start the engine again.</p> <p>► Try to start the engine again (▷ page 106). Avoid excessively long and frequent attempts to start the engine as these will drain the battery.</p> <p>If the engine does not start after several attempts:</p> <p>► Consult a qualified specialist workshop.</p>
The engine does not start. The starter motor can be heard. The yellow reserve fuel warning lamp is lit and the needle of the fuel gage display shows <b>0</b> .	<p>The fuel tank is empty.</p> <p>► Refuel the vehicle.</p>
The engine does not start. You cannot hear the starter motor.	<p>The on-board voltage is too low because the battery is too weak or discharged.</p> <p>► Jump-start the vehicle (▷ page 249).</p> <p>If the engine does not start despite attempts to jump-start it:</p> <p>► Consult a qualified specialist workshop.</p> <p>The starter motor was exposed to a thermal load that was too high.</p> <p>► Allow the starter motor to cool down for approximately two minutes.</p> <p>► Try to start the engine again.</p> <p>If the engine still does not start:</p> <p>► Consult a qualified specialist workshop.</p>
The engine is not running smoothly and is misfiring.	<p>There is a malfunction in the engine electronics or in a mechanical component of the engine management system.</p> <p>► Only depress the accelerator pedal slightly. Otherwise, non-combusted fuel may get into the catalytic converter and damage it.</p> <p>► Have the cause rectified immediately at a qualified specialist workshop.</p>



Problem	Possible causes/consequences and ► Solutions
The coolant temperature gauge is in the area marked in red behind the <b>H</b> . A display message may also appear in the multifunction display and a warning tone may sound.	The coolant level is too low. The coolant is too hot and the engine is no longer being cooled sufficiently. <ul style="list-style-type: none"> <li>► Stop as soon as possible and allow the engine and the coolant to cool down.</li> <li>► Check the coolant level (► page 234). Observe the warning notes as you do so and add coolant if necessary.</li> </ul>
	If the coolant level is correct, the radiator fan may be faulty. The coolant is too hot and the engine is no longer being cooled sufficiently. <ul style="list-style-type: none"> <li>► If the coolant temperature is below the <b>H</b> marking, drive to the nearest qualified specialist workshop.</li> <li>► Avoid heavy loads on the engine as you do so, e.g. driving in mountainous terrain and stop-and-go traffic.</li> </ul>

## Adjustable damping

### General notes

With adjustable damping you can choose between two different suspension settings.

### Suspension settings

<b>COMF</b>	comfortable suspension setting
<b>Sport</b>	sports suspension setting

### Selecting the suspension setting

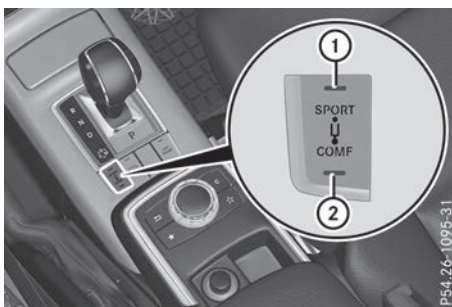

- i** If you select the sports suspension setting, the vehicle will dampen more roughly.
- Press button ①.  
The indicator lamp lights up. **SPORT** is displayed in the multifunction display. The sports suspension setting is activated.
- i** If you select the comfortable suspension setting, the vehicle will dampen more softly.

- Press button ②.  
The indicator lamp lights up. **COMF** is displayed in the multifunction display. The comfortable suspension setting is activated.

## Automatic transmission

### Important safety notes

#### **⚠ WARNING**

If the engine speed is above the idling speed and you engage transmission position **D** or **R**, the vehicle could pull away suddenly. There is a risk of an accident.

When engaging transmission position **D** or **R**, always firmly depress the brake pedal and do not simultaneously accelerate.

#### **⚠ WARNING**

The automatic transmission switches to neutral position **N** when you switch off the engine. The vehicle may roll away. There is a risk of an accident.

After switching off the engine, always switch to parking position **P**. Prevent the parked vehicle from rolling away by applying the parking brake.

- i** Bear in mind that the power transmission between the engine and the transmission is interrupted when the engine is switched off.

For this reason, shift the automatic transmission to **P** when the engine is switched off and the vehicle is stationary. Apply the parking brake to prevent the vehicle from rolling away.

### Selector lever

#### Overview of transmission positions

**!** If the engine speed is too high or the vehicle is in motion, do not shift the automatic transmission directly from **D** to **R**, from **R** to **D** or directly to **P**.

Do not open the driver's door while the vehicle is in motion. At low speeds in transmission position **D** or **R**, otherwise park position **P** is engaged automatically.

The transmission could be damaged.

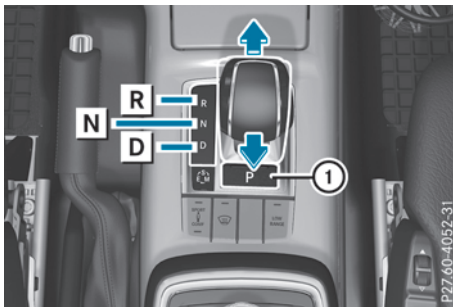

- ① **P** button: park position with parking lock
- R** Reverse gear
- N** Neutral
- D** Drive

When you select a transmission position, the selector lever subsequently returns to its original position.

The current transmission position **P**, **R**, **N** or **D** is shown on the transmission position display on the multifunction display.

#### Transmission position and drive program display

**!** If the transmission position display in the multifunction display is not working, you should pull away carefully to check whether the desired transmission position is engaged. Select transmission position **D**. Do not restrict the shift range.



Current transmission position ① and current drive program ② appear in the multifunction display.

The current position of the selector lever is shown by the indicators next to the selector lever.

The indicators light up when the SmartKey is inserted into the ignition lock. The indicators go out when the SmartKey is removed from the ignition lock.

When the selector lever is in position **D**, you can influence the gearshifts made by the automatic transmission by:

- restricting the shift range
- changing gear yourself

#### Selecting park position

- ▶ Make sure that the vehicle is stationary.
- ▶ Depress the brake pedal and keep it depressed.
- ▶ Press the **P** button on the center console.

If you depress the brake pedal and push the selector lever forwards or back to the first point of resistance, park position **P** is disengaged. The transmission shifts to neutral **N**.

#### Engaging reverse gear

**!** Only move the automatic transmission to **R** when the vehicle is stationary.

- ▶ Make sure that the vehicle is stationary.
- ▶ Depress the brake pedal and keep it depressed.
- ▶ Push the selector lever forwards past the first point of resistance.  
The transmission position **R** is engaged.

If you engage reverse gear and the ECO start/stop function is activated, the engine starts automatically (▷ page 107).

## Engaging neutral

### WARNING

If children are left unsupervised in the vehicle, they could:

- open the doors, thus endangering other people or road users.
- get out and disrupt traffic.
- operate the vehicle's equipment.

Additionally, children could set the vehicle in motion if, for example, they:

- release the parking brake.
- shifting the automatic transmission out of park position **P**
- Start the engine.

There is a risk of an accident and injury.

When leaving the vehicle, always take the SmartKey with you and lock the vehicle. Never leave children or animals unattended in the vehicle. Always keep the SmartKey out of reach of children.

- ▶ Make sure that the vehicle is stationary.
- ▶ Depress the brake pedal and keep it depressed.
- ▶ Depending on the current transmission position, press the selector lever forwards or backwards to the first point of resistance. The automatic transmission shifts to **N**.

When the engine is switched off, the automatic transmission shifts to **N** automatically.

If the vehicle is braked to a standstill in neutral **N**, the ECO start/stop function switches off the engine automatically (▷ page 107).

## Remaining in neutral

### WARNING

If children are left unsupervised in the vehicle, they could:

- open the doors, thus endangering other people or road users.
- get out and disrupt traffic.
- operate the vehicle's equipment.

Additionally, children could set the vehicle in motion if, for example, they:

- release the parking brake.
- shifting the automatic transmission out of park position **P**
- Start the engine.

There is a risk of an accident and injury.

When leaving the vehicle, always take the SmartKey with you and lock the vehicle. Never leave children or animals unattended in the vehicle. Always keep the SmartKey out of reach of children.

- ▶ Make sure that the vehicle is stationary.
- ▶ Make sure that the ignition is switched on.
- ▶ Depress the brake pedal and keep it depressed.
- ▶ Shift to neutral **N**.
- ▶ Release the brake pedal.
- ▶ Make sure that the parking brake is released.
- ▶ Switch off the ignition and leave the SmartKey in the ignition lock.

## Engaging the drive position

- ▶ Make sure that the vehicle is stationary.
- ▶ Depress the brake pedal and keep it depressed.
- ▶ Push the selector lever back past the first point of resistance. The automatic transmission shifts to **D**.

If the vehicle is braked to a standstill with the transmission in position **D**, the ECO start/stop function switches off the engine automatically (▷ page 107).

## Transmission positions

**P**

### Park position

This prevents the vehicle from rolling away when stopped.

Only shift the transmission into position **P** (> page 112) when the vehicle is stationary. The parking lock should not be used as a brake when parking. Always apply the parking brake in addition to the parking lock in order to secure the vehicle.

The SmartKey can only be removed if the transmission is in position **P**. When there is no SmartKey in the ignition lock, the selector lever is locked in position **P**.

**R**

### Reverse gear

Only shift the transmission into position **R** when the vehicle is stationary.

**N**

**!** Coasting in neutral **N** may cause damage to the drive train.

### Neutral

Do not shift the transmission to **N** while driving. The automatic transmission could otherwise be damaged.

No power is transmitted from the engine to the drive wheels.

Releasing the brakes will allow you to move the vehicle freely, e.g. to push it or tow it.

If ESP® is deactivated or faulty and the vehicle is in danger of skidding, e.g. on icy roads: shift the transmission to **N**.

If you engage the transfer case, shift briefly to **N** (> page 149).

**D**

### Drive

The automatic transmission changes gear automatically. All forward gears are available.

## Changing gear

The automatic transmission shifts through the individual gears automatically when it is in transmission position **D**. This automatic gear shifting behavior is determined by:

- a shift range restriction, if selected
- the position of the transfer case (**HIGH RANGE** or **LOW RANGE**)
- the position of the accelerator pedal
- the road speed

## Driving tips

### Accelerator pedal position

Your style of driving influences how the automatic transmission shifts gear:

- little throttle: early upshifts
- more throttle: late upshifts

### Kickdown

Use kickdown for maximum acceleration.

- ▶ Depress the accelerator pedal beyond the pressure point.  
The automatic transmission shifts to a lower gear depending on the engine speed.
- ▶ Ease off the accelerator pedal once the desired speed is reached.  
The automatic transmission shifts back up.

Kickdown is not available in the permanent manual drive program on Mercedes-AMG vehicles.

### Rocking the vehicle free

Rocking free by shifting back and forth between transmission positions **D** and **R** can help to free the vehicle if it gets stuck. The vehicle's engine management system limits the speed to a maximum of 5 mph (9 km/h) when shifting back and forth.

Shifting back and forth between transmission positions **D** and **R**:

- ▶ Move the selector lever forwards or backwards past the point of resistance.

## Towing a trailer

- ▶ Drive in the middle of the engine speed range on uphill gradients.
- ▶ **Vehicles except Mercedes-AMG vehicles:** limit the shift range to **3** or **2** depending on the uphill or downhill gradient (▷ page 116). This also applies if cruise control, the speed limiter or DISTRONIC PLUS is activated.  
**Mercedes-AMG vehicles:** shift down to shift range **3** or **2** depending on the uphill or downhill gradient (▷ page 116). This also applies if cruise control, the speed limiter or DISTRONIC PLUS is activated.
- ▶ Shift the transfer case into low-range driving position **LOW RANGE** on extreme uphill gradients or steep downhill gradients (▷ page 149).

## Program selector button

### General notes

The program selector button allows you to choose between drive programs with different driving characteristics.

On Mercedes-AMG vehicles, drive program **E** is called drive program **C**.

The automatic transmission switches to automatic drive program **E** (drive program **C** in Mercedes-AMG vehicles) each time the engine is started.

Only change from automatic drive program **C** or **S** to manual drive program **M** when the vehicle is stationary.

### Drive programs available for vehicles except Mercedes-AMG vehicles

<b>E</b> Economy	Comfortable, economical driving
<b>S</b> Sport	Sporty driving style
<b>M</b> Manual	Manual gear shifting

### Drive programs available for Mercedes-AMG vehicles

<b>C</b> Controlled Efficiency	Comfortable, economical driving
<b>S</b> Sport	Sporty driving style
<b>M</b> Manual	Manual gear shifting

For further information on the automatic drive program, see (▷ page 116).

### Selecting the drive program



Program selector button (except for Mercedes-AMG vehicles)



Program selector button (Mercedes-AMG vehicles)

- ▶ Press program selector button ① repeatedly until the desired drive program is shown in the multifunction display.

### Steering wheel paddle shifters

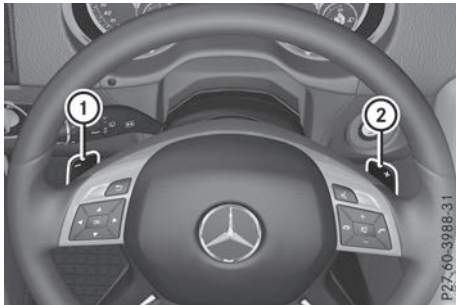

In the automatic drive program, you can restrict or derestrict the shift range by using steering wheel paddle shifters ① and ② (▷ page 116). In the manual drive program you can change gears manually using steering wheel paddle shifters ① and ② (▷ page 117).

You can only change gear with the steering wheel paddle shifters when the transmission is in position **D**.

### Automatic drive program

Drive program **E** (drive program **C** on Mercedes-AMG vehicles) is characterized by the following:

- comfort-oriented engine and transmission settings.
- optimal fuel consumption resulting from the automatic transmission shifting up sooner.
- the vehicle pulls away more gently in forward and reverse gears, unless the accelerator pedal is depressed fully.
- increased sensitivity. This improves driving stability on slippery road surfaces, for example.
- the automatic transmission shifting up sooner. This results in the vehicle being driven at lower engine speeds and the wheels being less likely to spin.

Drive program **S** is characterized by the following:

- sporty engine and transmission settings.
- the vehicle pulling away in first gear.
- the automatic transmission shifts up later.
- the fuel consumption possibly being higher as a result of the later automatic transmission shift points.

### Shift ranges

#### Introduction

It is not possible to set the shift range on Mercedes-AMG vehicles.

When the automatic transmission is in position **D**, it is possible to restrict or derestrict the shift range.

The shift range selected is shown in the multi-function display. The automatic transmission shifts only as far as the selected gear.

#### Driving situations

- |          |  |
|----------|--|
| <b>3</b> | You can use the engine's braking effect  |
| <b>2</b> | You can use the engine's braking effect<br>This setting is particularly suited for driving: <ul style="list-style-type: none"> <li>• on steep mountain roads</li> <li>• in mountainous terrain</li> <li>• in arduous conditions</li> </ul> |
| <b>1</b> | The braking effect of the engine can be utilized on extremely steep downhill gradients and long downhill stretches.  |

#### Restricting the shift range

- ▶ Pull the left-hand steering wheel paddle shifter (▷ page 116). The automatic transmission shifts down one gear and restricts the shift range to the relevant gear.

To protect against engine damage, the automatic transmission:

- does not shift down if doing so would cause the engine to exceed the maximum engine speed
- shifts up, even if the shift range is restricted, if the maximum engine speed for the shift range is reached and you continue to accelerate

### Derestricting the shift range

- ▶ Pull the right-hand steering wheel paddle shifter (▷ page 116). The automatic transmission shifts up one gear and restricts the shift range to the relevant gear.

### Clearing the shift range restriction

- ▶ Pull and hold the right-hand steering wheel paddle shifter (▷ page 116) until transmission position **D** is shown in the multifunction display. The automatic transmission shifts from the current shift range directly to **D**.

### Selecting the ideal shift range

- ▶ Pull the left-hand steering wheel paddle shifter (▷ page 116) and hold it in position. The automatic transmission shifts to the gear which allows optimum acceleration and deceleration. To do this, the automatic transmission shifts down one or more gears.

The automatic transmission cannot shift down beyond second gear. To shift to first gear, you have to pull the left steering wheel paddle shifter.

## Manual gear shifting

### Temporary setting



- ▶ **To activate:** shift the selector lever to position **P**.
- ▶ Pull steering wheel paddle shifter ① or ②.

Temporary setting will be active for a certain amount of time. Under certain conditions the minimum amount of time is extended, e.g. in the

case of lateral acceleration, during an overrun phase or when driving on steep terrain.

- ▶ **To deactivate:** pull steering wheel paddle shifter ② and hold it in place.
- or
- ▶ Use the lever to switch the transmission position.
- or
- ▶ Change the drive program.

### Shifting gears

- ! In manual mode, the automatic transmission does not shift up automatically even when the engine limiting speed for the current gear is reached. When the engine limiting speed is reached, the fuel supply is cut to prevent the engine from overrevving. Always make sure that the engine speed does not reach the red area of the tachometer. There is otherwise a risk of engine damage.

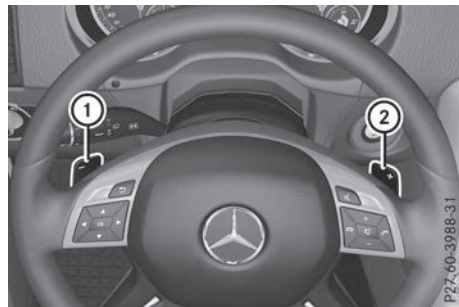

- ▶ **To shift up:** pull steering wheel paddle shifter ②. The automatic transmission shifts up to the next gear.
- ▶ **To shift down:** pull steering wheel paddle shifter ①. The automatic transmission shifts down to the next gear. Automatic down shifting occurs when coasting. If the engine exceeds the maximum engine speed when shifting down, the automatic transmission protects against engine damage by not shifting down.

### Shift recommendation



The gearshift recommendations assist you in adopting an economical driving style. The recommended gear is shown in the multifunction display.

- ▶ Shift to recommended gear ② according to gearshift recommendation ① when shown in the multifunction display of the instrument cluster.

### Manual drive program

#### General information

In manual drive program **M**, you can change gear yourself by using the steering wheel paddle shifters. The transmission must be in position **D** to do this. The gear currently selected and engaged is shown in the multifunction display. Manual drive program **M** differs from drive programs **C** and **S** with regard to spontaneity, responsiveness and smoothness of gear changes.

#### Switching on the manual drive program

- ▶ Shift the transmission to position **D**.
- ▶ Press the program selector button repeatedly until drive program **M** appears in the multifunction display.

#### Upshifting

- ⚠ When the engine limiting speed is reached, the fuel supply is cut to prevent the engine from overrevving. Always make sure that the engine speed does not reach the red area of the tachometer. There is otherwise a risk of engine damage.



- ▶ When gearshift recommendation ① appears on the multifunction display, pull the right-hand steering wheel paddle shifter (▷ page 116).

The automatic transmission shifts to recommended gear ②.

**G 500:** the automatic transmission shifts up automatically when the limiting speed of the engine is reached.

#### **G 350 d in transfer case position HIGH**

**RANGE:** the automatic transmission shifts up automatically when the limiting speed of the engine is reached.

#### **G 350 d in transfer case position LOW**

**RANGE:** the automatic transmission does not shift up automatically when the limiting speed of the engine is reached.

**Mercedes-AMG vehicles:** the automatic transmission does not shift up automatically when the limiting speed of the engine is reached.

#### Protection against reaching the over-revving range (Mercedes-AMG vehicles)

- ⚠ In manual mode, the automatic transmission does not shift up automatically even when the engine limiting speed for the current gear is reached. When the engine limiting speed is reached, the fuel supply is cut to prevent the engine from overrevving. Always make sure that the engine speed does not reach the red area of the tachometer. There is otherwise a risk of engine damage.



Before the engine speed reaches the red area, an upshift indicator will be shown in the multifunction display.



- ▶ When gearshift recommendation ① appears on the multifunction display, pull the right-hand steering wheel paddle shifter (> page 116).  
The automatic transmission shifts to recommended gear ②.

### Downshifting

- ▶ Pull the left-hand steering wheel paddle shifter (> page 116).  
The automatic transmission shifts down to the next gear.

If you slow down or stop without shifting down, the automatic transmission automatically shifts down.

### Selecting the optimal gear for maximum acceleration

- ▶ Pull the left-hand steering wheel paddle shifter until the transmission selects the optimum gear according to the speed.

### Switching off the manual drive program

- ▶ **All vehicles (except Mercedes-AMG vehicles):** press the program selector button repeatedly until **E** or **S** is shown in the multifunction display.
- ▶ **Mercedes-AMG vehicles:** press the program selector button repeatedly until **C** or **S** is shown in the multifunction display.

### Problems with the automatic transmission

Problem	Possible causes/consequences and ▶ Solutions
The transmission has problems shifting gear.	The transmission is losing oil. ▶ Have the transmission checked at a qualified specialist workshop immediately.
The acceleration ability is deteriorating. The transmission no longer changes gear.	The transmission is in emergency mode. It is only possible to shift into <b>second</b> gear and reverse gear. ▶ Stop the vehicle. ▶ Shift the transmission to position <b>P</b> . ▶ Turn the SmartKey to position <b>0</b> in the ignition lock. ▶ Wait at least ten seconds before restarting the engine. ▶ Shift the transmission to position <b>D</b> or <b>R</b> . If <b>D</b> is selected, the transmission shifts to <b>second</b> gear; if <b>R</b> is selected, the transmission shifts to reverse gear. ▶ Have the transmission checked at a qualified specialist workshop immediately.
You hear a warning tone.	You have: <ul style="list-style-type: none"> <li>• switched off the engine</li> <li>• opened the driver's door</li> <li>• not shifted the selector lever to position <b>P</b></li> </ul> ▶ Shift the selector lever to position <b>P</b> .

## Refueling

### Important safety notes

#### WARNING

Fuel is highly flammable. If you handle fuel incorrectly, there is a risk of fire and explosion.

You must avoid fire, open flames, creating sparks and smoking. Switch off the engine and, if applicable, the auxiliary heating before refueling.

#### WARNING

Fuel is poisonous and hazardous to health. There is a risk of injury.

You must make sure that fuel does not come into contact with your skin, eyes or clothing and that it is not swallowed. Do not inhale fuel vapors. Keep fuel away from children.

If you or others come into contact with fuel, observe the following:

- Wash away fuel from skin immediately using soap and water.
- If fuel comes into contact with your eyes, immediately rinse them thoroughly with clean water. Seek medical assistance without delay.
- If fuel is swallowed, seek medical assistance without delay. Do not induce vomiting.
- Immediately change out of clothing which has come into contact with fuel.

#### WARNING

Electrostatic buildup can create sparks and ignite fuel vapors. There is a risk of fire and explosion.

Always touch the vehicle body before opening the fuel filler flap or touching the fuel pump nozzle. Any existing electrostatic buildup is thereby discharged.

Do not get into the vehicle again during the refueling process. otherwise electrostatic charge could build up again.

 Do not use diesel to refuel vehicles with a gasoline engine. Do not switch on the ignition if you accidentally refuel with the wrong fuel. Otherwise, the fuel will enter the fuel system. Even small amounts of the wrong fuel could result in damage to the fuel system and the engine. Notify a qualified specialist workshop and have the fuel tank and fuel lines drained completely.

 Overfilling the fuel tank could damage the fuel system.

 Take care not to spill any fuel on painted surfaces. You could otherwise damage the paintwork.

 Use a filter when adding fuel from a fuel can. The fuel lines and/or the fuel injection system could otherwise be blocked by particles from the fuel can.

If you overfill the fuel tank, fuel could spray out when the fuel pump nozzle is removed.

For further information on fuel and fuel quality (> page 283).

## Refueling

### General information

Pay attention to the important safety notes (> page 120).

If you unlock/lock the vehicle from the outside, the fuel filler flap also unlocks/locks.

The position of the fuel filler cap is displayed in the instrument cluster . The arrow next to the filling pump indicates the side of the vehicle.

### Opening the fuel filler flap

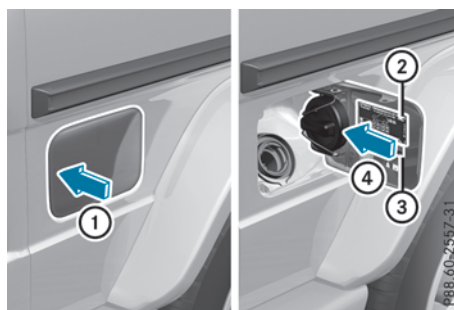

- ① To open the fuel filler flap
- ② Tire pressure table

- ③ Instruction label for fuel type to be refueled
- ④ To insert the fuel filler cap
  - ▶ Switch off the engine.
  - ▶ Remove the SmartKey from the ignition lock.
  - ▶ Press the fuel filler flap in the direction of arrow ①.
  - The fuel filler flap swings up.
  - ▶ Turn the fuel filler cap counterclockwise and remove it.
  - ▶ Insert the fuel filler cap into the holder bracket on the inside of filler flap ④.
  - ▶ Completely insert the filler neck of the fuel pump nozzle into the tank and refuel.
  - ▶ Only fill the tank until the pump nozzle switches off.

Do not add any more fuel after the pump stops filling for the first time. Otherwise, fuel may leak out.

### Closing the fuel filler flap

- ▶ Replace the cap on the filler neck and turn clockwise until it engages audibly.
- ▶ Close the fuel filler flap.

Close the fuel filler flap before locking the vehicle.

If you are driving with the fuel filler cap open, the  reserve fuel warning lamp flashes. A message appears in the multifunction display (▷ page 183).

The emergency release is located in the cargo compartment, on the right-hand side when viewed in the direction of travel, behind the rear panel trim.

- ▶ Open the rear door.
- ▶ Pull off edge protection ②.
- ▶ Remove rear wall trim ①.

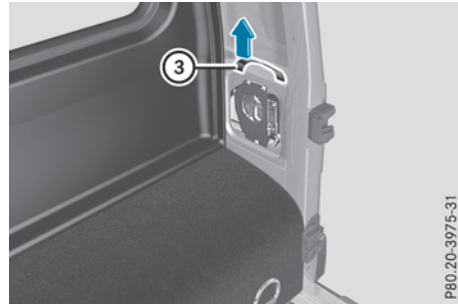

P80.20-3975-31

- ▶ Pull emergency release ③ in the direction of the arrow.  
The fuel filler flap is unlocked.
- ▶ Open the fuel filler flap (▷ page 120).

### Fuel filler flap emergency release

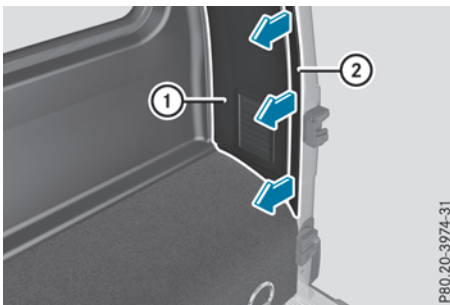

P80.20-3974-31

## Problems with the fuel and fuel tank

Problem	Possible causes/consequences and ► Solutions
Fuel is leaking from the vehicle.	<p> <b>WARNING</b></p> <p>The fuel line or the fuel tank is defective. There is a risk of fire or explosion.</p> <ul style="list-style-type: none"> <li>► Apply the parking brake.</li> <li>► Switch off the engine.</li> <li>► Remove the SmartKey from the ignition lock.</li> <li>► Do not restart the engine under any circumstances.</li> <li>► Consult a qualified specialist workshop.</li> </ul>
The fuel filler flap cannot be opened.	<p>The fuel filler flap is not unlocked.</p> <ul style="list-style-type: none"> <li>► Unlock the vehicle (▷ page 63).</li> <li>► Open the rear door.</li> <li>► Manually unlock the fuel filler flap using the emergency release (▷ page 121).</li> </ul>
	<p>The SmartKey battery is discharged or nearly discharged.</p> <ul style="list-style-type: none"> <li>► Unlock the vehicle using the mechanical key (▷ page 64).</li> </ul>
	<p>The fuel filler flap is unlocked, but the opening mechanism is jammed.</p> <ul style="list-style-type: none"> <li>► Manually unlock the fuel filler flap using the emergency release (▷ page 121).</li> <li>► Consult a qualified specialist workshop.</li> </ul>

## Parking

## Important safety notes

 **WARNING**

Flammable material such as leaves, grass or twigs may ignite if they come into contact with hot parts of the exhaust system or exhaust gas flow. There is a risk of fire.

Park the vehicle so that no flammable materials come into contact with parts of the vehicle which are hot. Take particular care not to park on dry grassland or harvested grain fields.

 **WARNING**

If you leave children unsupervised in the vehicle, they could set it in motion by, for example:

- release the parking brake.
- shift the automatic transmission out of the parking position **P**.
- start the engine.

In addition, they may operate vehicle equipment and become trapped. There is a risk of an accident and injury.

When leaving the vehicle, always take the SmartKey with you and lock the vehicle. Never leave children unsupervised in the vehicle.

To ensure that the vehicle is safeguarded against rolling away unintentionally:

- the parking brake must be applied.
- the transmission must be in position **P** and the SmartKey must be removed from the ignition lock
- the transfer case must not be in the neutral position
- the front wheels must be turned towards the curb on steep uphill or downhill gradients
- the empty vehicle must be secured at the front axle with a wheel chock or similar object, for example, on uphill or downhill gradients
- a laden vehicle must also be secured at the rear axle with a wheel chock or similar object, for example, on uphill or downhill gradients

### Switching off the engine

#### WARNING

The automatic transmission switches to neutral position **N** when you switch off the engine. The vehicle may roll away. There is a risk of an accident.

After switching off the engine, always switch to parking position **P**. Prevent the parked vehicle from rolling away by applying the parking brake.

- ▶ Shift the automatic transmission to position **P**.
- ▶ Turn the SmartKey to position **0** in the ignition lock and remove it. The immobilizer is activated.
- ▶ Apply the parking brake firmly.
- ▶ Turn the steering wheel until the steering wheel lock engages.

If you switch the engine off with the transmission in position **R** or **D** the automatic transmission shifts to **N** automatically.

If you then open the driver's door or the front-passenger door or remove the SmartKey from the ignition, the automatic transmission shifts to **P** automatically.

If you switch off the engine while the transmission is in position **N**, the automatic transmission remains in **N** even if a door is opened. The automatic transmission only automatically

shifts into **P** when you remove the SmartKey from the ignition lock.

### Parking brake

#### WARNING

If you must brake the vehicle with the parking brake, the braking distance is considerably longer and the wheels could lock. There is an increased danger of skidding and accidents. Only use the parking brake to brake the vehicle when the service brake is faulty. Do not apply the parking brake too firmly. If the wheels lock, release the parking brake until the wheels begin turning again.

#### WARNING

If you leave children unsupervised in the vehicle, they could set it in motion by, for example:

- release the parking brake.
- shift the automatic transmission out of the parking position **P**.
- start the engine.

In addition, they may operate vehicle equipment and become trapped. There is a risk of an accident and injury.

When leaving the vehicle, always take the SmartKey with you and lock the vehicle. Never leave children unsupervised in the vehicle.

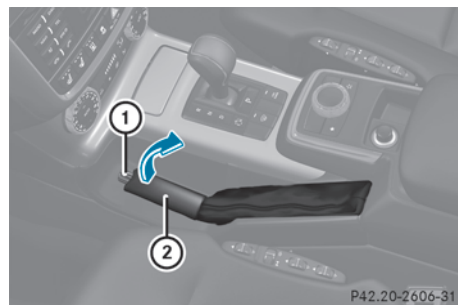

If you brake the vehicle with the parking brake, the brake lamps will not light up.

If you pull away with the parking brake applied, a warning tone sounds.

- ▶ **To apply:** pull parking brake lever ② up firmly.  
When the ignition is switched on, the **PARK** (USA only) or **(P)** (Canada only) indicator lamp in the instrument cluster lights up.
- ▶ **To release:** pull parking brake lever ② slightly.
- ▶ Press release button ① and guide parking brake ② down to the stop.  
The **PARK** (USA only) or **(P)** (Canada only) indicator lamp in the instrument cluster goes out.

The vehicle can also be braked during an emergency by using the parking brake.

- ▶ **To brake in an emergency:** press and hold release button ① and carefully pull parking brake lever ② upwards.

If you drive on wet roads or dirt-covered surfaces, road salt and/or dirt could get into the parking brake.

In order to prevent corrosion and a reduction in the braking power of the parking brake, observe the following:

- pull the parking brake up with release button ① depressed from time to time before beginning a journey
- drive for approximately 110 yds (100 m) at a maximum speed of 12 mph (20 km/h)

### Parking the vehicle for a long period

If you leave the vehicle parked for longer than four weeks, the battery may be damaged by exhaustive discharging.

If you leave the vehicle parked for longer than six weeks, the vehicle may suffer damage as a result of lack of use.

- ▶ Visit a qualified specialist workshop and seek advice.
- ▶ **i** You can obtain information about trickle chargers from a qualified specialist workshop.

## Driving tips

### General driving tips

### Important safety notes

#### WARNING

If you switch off the ignition while driving, safety-relevant functions are only available with limitations, or not at all. This could affect, for example, the power steering and the brake boosting effect. You will require considerably more effort to steer and brake. There is a risk of an accident.

Do not switch off the ignition while driving.

#### WARNING

If you operate mobile communication equipment when driving, you may be distracted from the traffic situation. You could also lose control of the vehicle. There is a risk of an accident.

Only operate this equipment when the vehicle is stationary.

Observe the legal requirements for the country in which you are driving. Some jurisdictions prohibit the driver from using a mobile phone while driving a vehicle.

If you make a call while driving, always use hands-free mode. Only operate the telephone when the traffic situation permits. If you are unsure, pull over to a safe location and stop before operating the telephone.

Bear in mind that at a speed of only 30 mph (approximately 50 km/h), the vehicle covers a distance of 44 ft (approximately 14 m) per second.

### Drive sensibly – save fuel

Observe the following tips to save fuel:

- ▶ The tires should always be inflated to the recommended tire pressure.
- ▶ Remove unnecessary loads.
- ▶ Remove roof carriers when they are not needed.
- ▶ Warm up the engine at low engine speeds.

- ▶ Avoid frequent acceleration or braking.
- ▶ Have all service and maintenance work carried out at the specified intervals.

Fuel consumption also increases when driving in cold weather, in stop-start traffic and in hilly terrain.

### Drinking and driving

#### WARNING

Drinking and driving and/or taking drugs and driving are very dangerous combinations. Even a small amount of alcohol or drugs can affect your reflexes, perceptions and judgment.

The possibility of a serious or even fatal accident is greatly increased when you drink or take drugs and drive.

Do not drink or take drugs and drive or allow anyone to drive who has been drinking or taking drugs.

### Emission control

#### WARNING

Combustion engines emit poisonous exhaust gases such as carbon monoxide. Inhaling these exhaust gases leads to poisoning. There is a risk of fatal injury. Therefore never leave the engine running in enclosed spaces without sufficient ventilation.

Certain engine systems are designed to keep the level of poisonous components in exhaust fumes within legal limits.

These systems only work at peak efficiency if they are serviced exactly in accordance with the manufacturer's specifications. Always have work on the engine carried out at a qualified specialist workshop. Mercedes-Benz recommends that you use an authorized Mercedes-Benz Center for this purpose. In particular, work relevant to safety or on safety-related systems must be carried out at a qualified specialist workshop.

The engine settings must not be changed under any circumstances. Furthermore, all specific service work must be carried out at regular intervals and in accordance with the Mercedes-Benz service requirements. You can obtain cur-

rent information concerning the servicing of your vehicle at any time from a qualified specialist workshop. This could be an overview of the maintenance work or any additional maintenance work, for example.

### Braking

#### Important safety notes

#### WARNING

If you shift down on a slippery road surface in an attempt to increase the engine's braking effect, the drive wheels could lose their grip. There is an increased danger of skidding and accidents.

Do not shift down for additional engine braking on a slippery road surface.

#### WARNING

If you select the LOW RANGE off-road gear on a slippery road surface, the wheels could lose traction:

- if you remove your foot from the accelerator pedal when driving
- if off road ABS intervenes when braking

If the wheels lose traction, the vehicle can no longer be steered. There is an increased danger of skidding and accidents.

Never select the LOW RANGE off-road gear when driving on slippery road surfaces.

Information on the parking brake (▷ page 123).

### Downhill gradients

 On long and steep gradients, you must reduce the load on the brakes by shifting to a lower gear in good time. This allows you to take advantage of the engine's braking effect. This helps you to avoid overheating the brakes and wearing them out excessively.

When you take advantage of engine braking, a drive wheel may not turn for some time, e.g. on a slippery road surface. This could cause damage to the drive train. This type of damage is not covered by the Mercedes-Benz warranty.

This also applies if cruise control or DISTRONIC PLUS is activated.

### Heavy and light loads

#### WARNING

If you rest your foot on the brake pedal while driving, the braking system can overheat. This increases the stopping distance and can even cause the braking system to fail. There is a risk of an accident.

Never use the brake pedal as a footrest. Never depress the brake pedal and the accelerator pedal at the same time.

-  Depressing the brake pedal constantly results in excessive and premature wear to the brake pads.

If the brakes have been subjected to a heavy load, do not stop the vehicle immediately. Drive on for a short while. This allows the airflow to cool the brakes more quickly.

### Wet roads

If driving in heavy rain for a prolonged period of time without braking, there may be a delayed reaction from the brakes when braking for the first time. This may also occur after the vehicle has been washed.

You have to depress the brake pedal more firmly. Maintain a greater distance from the vehicle in front.

After driving on a wet road or having the vehicle washed, brake firmly while paying attention to the traffic conditions. This will warm up the brake discs, thereby drying them more quickly and protecting them against corrosion.

### Limited braking performance on salt-treated roads

If you drive on salted roads, a layer of salt residue may form on the brake discs and brake pads. This can result in a significantly longer braking distance.

- In order to prevent any salt build-up, apply the brakes occasionally while paying attention to the traffic conditions.
- Carefully depress the brake pedal at the beginning and end of a journey.
- Maintain a greater distance to the vehicle ahead.

### Servicing the brakes

-  The brake fluid level may be too low, if:
  - if the red brake warning lamp lights up in the instrument cluster and
  - you hear a warning tone while the engine is running

Observe additional warning messages in the multifunction display.

The brake fluid level may be too low due to brake pad wear or leaking brake lines.

Have the brake system checked immediately. Consult a qualified specialist workshop to arrange this.

-  If the brake warning lamp lights up in the instrument cluster and you hear a warning tone even though the parking brake has been released, the brake fluid level may be too low. Observe additional warning messages in the multifunction display.

The brake fluid level may be too low due to brake pad wear or leaking brake lines.

Have the brake system checked immediately. This work should be carried out at a qualified specialist workshop.

-  A function or performance test should only be carried out on a 2-axle dynamometer. If you wish to operate the vehicle on such a dynamometer, please consult a qualified specialist workshop in advance. You could otherwise damage the drive train or the brake system.

-  The ESP<sup>®</sup> system operates automatically. If the parking brake is tested on a brake dynamometer (for a maximum of ten seconds), the engine and the ignition must be switched off. Braking triggered automatically by ESP<sup>®</sup> may otherwise cause severe damage to the brake system.

All checks and maintenance work on the brake system must be carried out at a qualified specialist workshop.



Have brake pads installed and brake fluid replaced at a qualified specialist workshop.

If the brake system has only been subject to moderate loads, you should test the functionality of your brakes at regular intervals.

Information on BAS (Brake Assist) (▷ page 59).

For safety reasons, Mercedes-Benz recommends only installing the following brake disks and brake pads/linings:

- brake disks that have been approved by Mercedes-Benz
- brake pads/linings that have been approved by Mercedes-Benz or that are of an equivalent standard of quality

Other brake disks or brake pads/linings can compromise the safety of your vehicle.

Always replace all brake disks and brake pads/linings on an axle at the same time. Always install new brake pads/linings when replacing brake disks.

The vehicle is equipped with lightweight brake disks to which the wheel assembly with rim and threaded connection is matched.

The use of brake discs other than those approved by Mercedes-Benz may alter track width and is subject to approval, if applicable.

Shock-type loads when handling the brake discs, such as when changing wheels, can lead to a reduction in comfort when driving with lightweight brake discs. Avoid shock-type loads on the lightweight brake disks, particularly on the brake plate.

Mercedes-Benz recommends that you only use brake fluid that has been specially approved for your vehicle by Mercedes-Benz, or which corresponds to an equivalent quality standard. Brake fluid which has not been approved for Mercedes-Benz vehicles or which is not of an equivalent quality could affect your vehicle's operating safety.

### High-performance brake (Mercedes-AMG vehicles)

The AMG brake systems are designed for heavy loads. This may lead to noise when braking.

This will depend on:

- Speed
- Braking force
- Ambient conditions, e.g. temperature and humidity

The wear of individual brake system components such as the brake pads/linings or brake discs depends on individual driving style and operating conditions.

For this reason, it is impossible to state a mileage that will be valid under all circumstances. An aggressive driving style will lead to high wear. You can obtain more information on this from a qualified specialist workshop.

New and replaced brake pads and discs only reach their optimum braking effect after several hundred kilometers of driving. Compensate for this by applying greater force to the brake pedal. Keep this in mind, and adapt your driving and braking accordingly during this break-in period.

Excessive heavy braking results in correspondingly high brake wear. If the brake pads/linings have reached their wear limit, the multifunction display shows a corresponding message. Especially for high performance driving, it is important to maintain and have the brake system checked regularly.

### Driving on slippery surfaces

❗ Where possible, avoid spinning the drive wheels when pulling away on slippery roads. You could otherwise damage the drive train. This type of damage is not covered by the terms of the Mercedes-Benz warranty.

- ▶ Engage the differential locks if necessary (▷ page 151).

### Driving on wet roads

#### Hydroplaning

If water has accumulated to a certain depth on the road surface, there is a danger of hydroplaning occurring, even if:

- you drive at low speeds
- the tires have adequate tread depth

For this reason, in the event of heavy rain or in conditions in which hydroplaning may occur, you must drive in the following manner:

- lower your speed
- avoid ruts
- avoid sudden steering movements
- brake carefully

### Driving on flooded roads

**!** Do not drive through flooded areas. Check the depth of any water before driving through it. Drive slowly through standing water. Otherwise, water may enter the vehicle interior or the engine compartment. This can damage the electronic components in the engine or the automatic transmission. Water can also be drawn in by the engine's air suction nozzles and this can cause engine damage.

If you have to drive on stretches of road on which water has collected, please bear in mind that:

- in the case of standing water, the water level must be no higher than the lower edge of the vehicle body
- you should drive no faster than walking pace

### Off-road fording

**!** Under no circumstances should you accelerate before entering the water. The bow wave could cause water to enter and damage the engine and other assemblies.

**!** Do not open any of the vehicle's doors while fording. Otherwise, water could get into the vehicle interior and damage the vehicle's electronics and interior equipment.

**i** You may only drive through fresh water.

- Observe the safety notes (> page 129) and general notes (> page 130) on driving off-road.
- Establish how deep the water is and the characteristics of the body of water before fording.
- Switch off automatic climate control
- Shift the transfer case to the off-road driving position **LOW RANGE** (> page 149).
- Engage the differential locks if necessary (> page 151).
- Avoid high engine speeds.
- Enter and exit the water at a flat place and at a steady walking pace.
- Drive slowly and at an even speed through the water.
- Ensure that a bow wave does not form as you drive.
- Do not stop and do not switch off the engine. Water offers a high degree of resistance, and the ground is slippery and in some cases

unstable. Therefore, it is difficult and dangerous to pull away in water.

- Clean any mud from the tire tread after fording.
- Apply the brakes to dry them after fording.

Always observe the fording depth values (> page 290).

### Winter driving

#### **!** WARNING

If you shift down on a slippery road surface in an attempt to increase the engine's braking effect, the drive wheels could lose their grip. There is an increased danger of skidding and accidents.

Do not shift down for additional engine braking on a slippery road surface.

#### **!** WARNING

If you select the **LOW RANGE** off-road gear on a slippery road surface, the wheels could lose traction:

- if you remove your foot from the accelerator pedal when driving
- if off road ABS intervenes when braking

If the wheels lose traction, the vehicle can no longer be steered. There is an increased danger of skidding and accidents.

Never select the **LOW RANGE** off-road gear when driving on slippery road surfaces.

Have your vehicle winter-proofed at a qualified specialist workshop at the onset of winter.

Drive particularly carefully on slippery road surfaces. Avoid sudden acceleration, steering and braking maneuvers. Do not use cruise control or **DISTRONIC PLUS**.

If the vehicle threatens to skid or cannot be stopped when moving at low speed:

- ▶ Shift the automatic transmission to position **N**.

The outside temperature indicator is not designed to serve as an ice-warning device and is therefore unsuitable for that purpose.

Changes in the outside temperature are displayed after a short delay.

Indicated temperatures just above the freezing point do not guarantee that the road surface is free of ice. The road may still be icy, especially in wooded areas or on bridges. The vehicle could skid if you fail to adapt your driving style. Always adapt your driving style and drive at a speed to suit the prevailing weather conditions.

You should pay special attention to road conditions when temperatures are around freezing point.

For more information on driving with snow chains, see (▷ page 259).

For more information on driving with summer tires, see (▷ page 259).

Observe the notes in the "Winter operation" section (▷ page 258).

## Off-road driving

### Important safety notes

#### WARNING

If you drive on a steep incline at an angle or turn when driving on an incline, the vehicle could slip sideways, tip and rollover. There is a risk of an accident.

Always drive on a steep incline in the line of fall (straight up or down) and do not turn the vehicle.

#### WARNING

Flammable material such as leaves, grass or twigs may ignite if they come into contact with hot parts of the exhaust system. There is a risk of fire.

When driving off road or on unpaved roads, check the vehicle's underside regularly. In particular, remove parts of plants or other flammable materials which have become trapped. In the case of damage, contact a qualified specialist workshop.

 There is a risk of damage to the vehicle if:

- the vehicle becomes stuck, e.g. on a high curb or an unpaved road
- you drive too fast over an obstacle, e.g. a curb, a speed bump or a pothole in the road
- a heavy object strikes the underbody or parts of the chassis

In situations like this, the body, the underbody, chassis parts, wheels or tires could be damaged without the damage being visible. Components damaged in this way can unexpectedly fail or, in the case of an accident, no longer withstand the loads they are designed to.

If the underbody paneling is damaged, combustible materials such as leaves, grass or twigs can gather between the underbody and the underbody paneling. If these materials come in contact with hot parts of the exhaust system, they can catch fire.

In such situations, have the vehicle checked and repaired immediately at a qualified specialist workshop. If on continuing your journey you notice that driving safety is impaired, pull over and stop the vehicle immediately, paying attention to road and traffic conditions. In such cases, consult a qualified specialist workshop.

When driving off-road, substances such as sand, mud and water or water mixed with oil may get into the brakes. This may lead to a reduction in braking performance or total brake failure as a result of increased wear. The braking characteristics change depending on the material entering the brakes. Clean the brakes after driving off-road. If you detect a reduced braking effect or grinding noises, have the brake system checked in a qualified specialist workshop as soon as possible. Adapt your driving style to the different braking characteristics.

Driving off-road increases the likelihood of damage to the vehicle, which, in turn, can lead to failure of the mechanical assembly or systems. Adapt your driving style to suit the terrain conditions. Drive carefully. Have damage to the vehicle rectified immediately at a qualified specialist workshop.

Do not shift into transmission position **N** when driving off-road. You could lose control of the vehicle if you attempt to brake the vehicle using the service brake. If the gradient is too steep for your vehicle, drive back down in reverse gear.

## General notes



### Environmental note

Protection of the environment is of primary importance. Treat nature with respect. Observe all prohibiting signs.

Read this section carefully before driving your vehicle off-road. Practice by driving over more gentle off-road terrain first.

Familiarize yourself with the characteristics of your vehicle and the gear shift operation before driving through difficult terrain.

The following driving systems are specially adapted to off-road driving:

- 4ETS (▷ page 59)
- Off-road ABS (▷ page 59)
- Transfer case (▷ page 149)
- Differential locks (▷ page 151)

Observe the following notes:

- stop the vehicle before you drive off-road and, if necessary, shift the transfer case to the **LOW RANGE** off-road gear (▷ page 149).
- Engage the differential locks if necessary (▷ page 151).

**i** ABS, 4ETS, ESP® and BAS are deactivated while the differential locks are engaged. This allows the front wheels to lock briefly, so that these can dig into a loose surface. However, please note that locked wheels skid and can no longer steer.

- Check that items of luggage and loads are stowed safely and are well secured (▷ page 214).
- To avoid damaging the vehicle, make sure there is always sufficient ground clearance.
- Always keep the engine running and in gear when driving on a downhill gradient.
- Always keep the engine running and in gear when driving down an incline.
- Drive slowly and evenly, if necessary at a walking pace.
- Ensure that the wheels are in contact with the ground at all times.
- Drive with extreme care on unfamiliar off-road routes where visibility is poor. For safety reasons, get out of the vehicle first and survey the off-road route.
- Check the depth of water before fording rivers and streams.

- Watch out for obstacles.
- Always keep the doors, rear door, side windows and the sliding sunroof closed while the vehicle is in motion.
- Switch off cruise control.
- Do not deviate from marked routes.
- Adapt your speed to the terrain. The rougher, steeper or more ruts on the terrain, the slower your speed should be.
- Do not jump with the vehicle, as this will interrupt the vehicle's propulsion.
- Avoid high engine speeds. Drive at appropriate engine speeds (maximum 3,000 rpm).
- Do not shift the automatic transmission to position **[N]**.
- Always check the vehicle for damage after off-road driving.

Do not use the HOLD function when driving off-road, on steep uphill or downhill gradients or on slippery or loose surfaces. The HOLD function cannot hold the vehicle on such surfaces.

You can obtain further information about mounting special all-terrain tires from a qualified specialist workshop.

## Checklist before driving off-road

**!** If the engine oil warning lamp lights up while the vehicle is in motion, stop the vehicle in a safe place as soon as possible. Check the engine oil level. The engine oil warning lamp warning must not be ignored. Continuing the journey while the symbol is displayed could lead to engine damage.

- ▶ **Engine oil level:** check the engine oil level and add oil if necessary.  
When driving on steep gradients, the engine oil level must be sufficiently high to ensure a correct oil supply in the vehicle.
- ▶ **Tire-changing tool kit:** check that the jack is working and make sure you have the lug wrench, a robust tow cable and a folding spade in the vehicle.
- ▶ **Wheels and tires:** check the tire tread depth and tire pressure.
- ▶ Check for damage and remove any foreign objects, e.g. small stones, from the wheels/tires.
- ▶ Replace any missing valve caps.

- ▶ Replace dented or damaged wheels. Also check the spare wheel.
- ▶ **Rims:** dented or bent rims can result in a loss of tire pressure and damage the tire bead. Before driving off-road, check the wheels and replace them if necessary.

### Checklist after driving off-road

**!** If you detect damage to the vehicle after driving off-road, have the vehicle checked immediately at a qualified specialist workshop.

Driving over rough terrain places greater demands on your vehicle than driving on normal roads. After driving off-road, check the vehicle. This allows you to detect damage promptly and reduce the risk of an accident to yourself and other road users.

- ▶ Shift the transfer case to the on-road position **HIGH RANGE** (▷ page 149).
- ▶ Disengage the differential locks (▷ page 153).
- ▶ Clean the headlamps and rear lights and check for damage.
- ▶ Clean the front and rear license plates.
- ▶ Clean the wheels and tires with a water jet and remove any foreign objects.
- ▶ Clean the wheels, wheel housings and the vehicle underside with a water jet; check for any foreign objects and damage.
- ▶ Check whether twigs or other parts of plants have become trapped. These increase the risk of fire and can damage fuel pipes, brake hoses or the rubber bellows of the axle joints and propeller shafts.
- ▶ After the trip, examine without fail the entire undercarriage, wheels, tires, brakes, bodywork structure, steering, chassis and exhaust system for damage.
- ▶ After driving in sand, mud, gravel, water or similar dirty conditions, have the following checked and cleaned:
  - brake discs
  - wheels
  - brake pads
  - axle joints
- ▶ If you notice strong vibrations after off-road driving, check for foreign objects in the wheels and drive train and, if necessary,

remove them. Foreign objects can disturb the balance and cause vibrations.

- ▶ Carry out a brake test.

### Driving on sand

Observe the following rules when driving on sand:

- Shift the transfer case to the off-road driving position **LOW RANGE** (▷ page 149).
- Avoid high engine speeds.
- Shift the automatic transmission to a low gear.
- Drive quickly to overcome the rolling resistance. Otherwise the vehicle's wheels could become stuck in loose ground.
- Drive in the tracks of other vehicles if possible. When doing so, make sure that:
  - the tire ruts are not too deep
  - the sand is sufficiently firm
  - your vehicle has sufficient ground clearance

### Tire ruts and gravel roads

**!** Check that the ruts are not too deep and that your vehicle has sufficient clearance. Otherwise, your vehicle could be damaged or bottom out and get stuck.

Observe the following rules when driving along ruts in off-road terrain or on roads with loose gravel:

- Shift the transfer case to the off-road driving position **LOW RANGE** (▷ page 149).
- Avoid high engine speeds.
- Observe the safety notes (▷ page 129) and the general notes (▷ page 130) on off-road driving.
- Shift the automatic transmission to a low gear.
- Drive slowly.
- Where ruts are too deep, drive with the wheels of one side on the center grassy area, if possible.

### Driving over obstacles

**!** Obstacles could damage the floor of the vehicle or components of the chassis. Ask passengers for guidance when driving over large obstacles. The passenger should always

keep a safe distance from the vehicle when doing so in order to avoid injury as a result of unexpected vehicle movements. After driving off-road or over obstacles, check the vehicle for possible damage, especially to the underbody and the components of the chassis.

**!** Drive with particular care when driving over an obstacle while driving up or down a steep slope.

The vehicle could otherwise tilt and slide sideways or tip over.

Observe the following rules when driving over tree stumps, large stones and other obstacles:

- Observe the safety notes (▷ page 129) and the general notes (▷ page 130) on off-road driving.
- Shift the transfer case to the off-road driving position **LOW RANGE** (▷ page 149).
- Avoid high engine speeds.
- Shift the automatic transmission to a low gear.
- Make sure that you have enough ground clearance before driving across an obstacle.
- Drive very slowly.
- Try to drive straight over the center of obstacles: front wheel first, then rear wheel.

### Traveling uphill

#### Approach/departure angle

##### **WARNING**

If you drive on a steep incline at an angle or turn when driving on an incline, the vehicle could slip sideways, tip and rollover. There is a risk of an accident.

Always drive on a steep incline in the line of fall (straight up or down) and do not turn the vehicle.

Always observe the approach/departure angle values (▷ page 290).

- Observe the safety notes (▷ page 129) and general notes (▷ page 130) on driving off-road.
- Do not drive at an angle on slopes, inclines or gradients, but instead follow the direct line of fall. Note that the climbing ability of your vehicle depends on the terrain conditions.

- Before driving on extreme uphill and downhill gradients, shift the transfer case to the **LOW RANGE** off-road gear (▷ page 149).
  - Engage the differential locks if necessary (▷ page 151).
  - Drive slowly.
  - Accelerate gently and make sure that the wheels are gripping.
  - Avoid high engine speeds, except when driving on sandy and muddy routes with high driving resistance.
  - Avoid high engine speeds – drive at an appropriate engine speed (maximum 3,000 rpm).
  - When driving down an incline, make use of the engine's braking effect. Observe the engine speed; do not overrev the engine.
- Further information on the maximum engine speed (▷ page 160).
- Shift the automatic transmission to a low gear appropriate for tackling an uphill gradient or a long, steep downhill gradient.

Hill start assist will aid you when pulling away on a hill. For further information about hill start assist, see (▷ page 107).

#### Maximum gradient-climbing capability

Always observe the maximum gradient climbing ability values (▷ page 290).

#### Hilltops

When driving up an uphill gradient, slightly reduce pressure on the accelerator immediately before reaching the brow of the hill (do not shift the transmission into **N**). Make use of the vehicle's own impetus to travel over the brow.

This style of driving prevents:

- the vehicle from lifting off the ground on the brow of a hill
- loss of traction
- the vehicle from traveling too quickly down the other side

#### Driving downhill

- Drive slowly.
- Do not drive at an angle down steep inclines. Steer into the line of fall and drive with the front wheels aligned straight. Otherwise, the vehicle could slip sideways, tip and rollover.

- Before tackling steep downhill gradients, shift the automatic transmission to a low gear.  
By doing so, you will use the braking effect of the engine to reduce the speed. If this is not sufficient, brake gently. When doing so, make sure that the vehicle is facing in the direction of the line of fall.
- Observe the notes on driving in mountainous terrain (▷ page 132).
- Check that the service brake is working normally after a long downhill stretch.

When driving at speeds below 37 mph (60 km/h), off-road ABS is activated and the front wheels lock cyclically during braking. The digging-in effect achieved in the process reduces the stopping distance on off-road terrain. This limits steering capability.

## Driving systems

### Cruise control

#### General notes

Cruise control maintains a constant road speed for you. It brakes automatically in order to avoid exceeding the set speed. Change into a lower gear in good time on long and steep downhill gradients.

This is especially important if the vehicle is laden. By doing so, you will make use of the braking effect of the engine. This relieves the load on the brake system and prevents the brakes from overheating and wearing too quickly.

Use cruise control only if road and traffic conditions make it appropriate to maintain a steady speed for a prolonged period. You can store any road speed above 20 mph (30 km/h).

Do not activate cruise control on off-road journeys.

#### Important safety notes

Cruise control can neither reduce the risk of an accident if you fail to adapt your driving style nor override the laws of physics. Cruise control cannot take into account the road, traffic and weather conditions. Cruise control is only an aid. You are responsible for maintaining a safe distance to the vehicle in front, for vehicle speed, for braking in good time and for staying in lane.

Do not use cruise control:

- in road and traffic conditions that do not allow you to maintain a constant speed, e.g. in heavy traffic, on winding roads or on rough terrain
- on slippery road surfaces. Braking or accelerating could cause the drive wheels to lose traction and the vehicle could then skid
- in poor visibility, e.g. due to fog, heavy rain or snow

If there is a change of drivers, advise the new driver of the speed stored.

- ❗ The speed indicated in the speedometer may differ slightly from the speed stored.

#### Cruise control lever

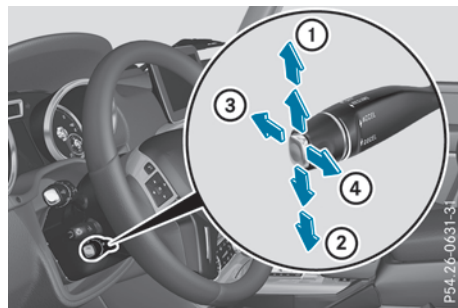

- ① Activates or increases speed
- ② Activates or reduces speed
- ③ Deactivates cruise control
- ④ Activates at the current speed/last stored speed

When you activate cruise control, the stored speed is shown in the multifunction display for five seconds.

**Speedometer with segments:** when cruise control is activated, the segments from the stored speed to the end of the scale light up.

#### Storing, maintaining and calling up a speed

##### Storing and maintaining the current speed

You can store the current speed if you are driving faster than 20 mph (30 km/h).

- ▶ Accelerate the vehicle to the desired speed.
- ▶ Briefly press the cruise control lever up ① or down ②.
- ▶ Remove your foot from the accelerator pedal. Cruise control is activated. The vehicle automatically maintains the stored speed.

**i** Cruise control may be unable to maintain the stored speed on uphill and downhill gradients. The stored speed is resumed when the gradient levels out. Cruise control maintains the stored speed on downhill gradients by automatically applying the brakes.

### Calling up the stored speed

#### WARNING

If you call up the stored speed and it is lower than the current speed, the vehicle decelerates. If you do not know the stored speed, the vehicle could decelerate unexpectedly. There is a risk of an accident.

Pay attention to the road and traffic conditions before calling up the stored speed. If you do not know the stored speed, store the desired speed again.

- ▶ Briefly pull the cruise control lever towards you ④.
- ▶ Remove your foot from the accelerator pedal. Cruise control is activated and adjusts the vehicle's speed to the last speed stored. If no speed is stored, cruise control stores the current speed and maintains it.

### Setting a speed

Keep in mind that it may take a brief moment until the vehicle has accelerated or braked to the speed set.

- ▶ Press the cruise control lever up ① for a higher speed or down ② for a lower speed.
- ▶ **To adjust the set speed in 1 mph increments (1 km/h increments):** briefly press the cruise control lever up ① or down ② to the pressure point. Every time the cruise control lever is pressed up ① or down ② the last speed stored is increased or reduced.
- ▶ **To adjust the set speed in 5 mph increments (10 km/h increments):** briefly press

the cruise control lever up ① or down ② beyond the pressure point.

Every time the cruise control lever is pressed up ① or down ② the last speed stored is increased or reduced.

**i** Cruise control is not deactivated if you depress the accelerator pedal. If you accelerate to overtake, cruise control adjusts the vehicle's speed to the last speed stored after you have finished overtaking.

### Deactivating cruise control

There are several ways to deactivate cruise control:

- ▶ Briefly press the cruise control lever forwards ③.

or

- ▶ Brake.

Cruise control is automatically deactivated if:

- you apply the parking brake
- you are driving at less than 20 mph (30 km/h)
- ESP® intervenes or you deactivate ESP®
- you shift the automatic transmission to position **N** while driving
- you engage a differential lock

If cruise control is deactivated, a warning tone sounds. You will see the **Cruise Control Off** message in the multifunction display for approximately five seconds. The message on the multifunction display disappears and the segments on the speedometer go out.

**i** When you switch off the engine, the last speed stored is cleared.

### DISTRONIC PLUS

#### General notes

DISTRONIC PLUS regulates the speed and automatically helps you maintain the distance from the vehicle detected in front. Vehicles are detected with the aid of the radar sensor system. DISTRONIC PLUS brakes automatically so that the set speed is not exceeded.

Change into a lower gear in good time on long and steep downhill gradients.

This is especially important if the vehicle is laden. By doing so, you will make use of the braking effect of the engine. This relieves the



load on the brake system and prevents the brakes from overheating and wearing too quickly.

If DISTRONIC PLUS detects a critical risk of collision with the vehicle in front, you will be warned visually and acoustically. DISTRONIC PLUS cannot prevent a collision without your intervention. An intermittent warning tone sounds and the  distance warning lamp in the instrument cluster lights up. Brake immediately in order to increase the distance to the vehicle in front or take evasive action provided it is safe to do so. DISTRONIC PLUS operates in the speed range between 0 mph (0 km/h) and 120 mph (200 km/h).

Do not use DISTRONIC PLUS while driving on roads with steep gradients.

As DISTRONIC PLUS transmits radar waves, it can resemble the radar detectors of the responsible authorities. You can refer to the relevant chapter in the Operator's Manual if questions are asked about this.

**i** USA only: This device has been approved by the FCC as a "Vehicular Radar System". The radar sensor is intended for use in an automotive radar system only. Removal, tampering, or altering of the device will void any warranties, and is not permitted by the FCC. Do not tamper with, alter, or use in any non-approved way.

Any unauthorized modification to this device could void the user's authority to operate the equipment.

**i** Canada only: This device complies with RSS-210 of Industry Canada. Operation is subject to the following two conditions:

1. This device may not cause interference, and
2. This device must accept any interference received, including interference that may cause undesired operation of the device.

Removal, tampering, or altering of the device will void any warranties, and is not permitted. Do not tamper with, alter, or use in any non-approved way.

Any unauthorized modification to this device could void the user's authority to operate the equipment.

## Important safety notes

### WARNING

DISTRONIC PLUS does not react to:

- people or animals
- stationary obstacles on the road, e.g. stopped or parked vehicles
- oncoming and crossing traffic

As a result, DISTRONIC PLUS may neither give warnings nor intervene in such situations.

There is a risk of an accident.

Always pay careful attention to the traffic situation and be ready to brake.

### WARNING

DISTRONIC PLUS cannot always clearly identify other road users and complex traffic situations.

In such cases, DISTRONIC PLUS may:

- give an unnecessary warning and then brake the vehicle
- neither give a warning nor intervene
- accelerate or brake unexpectedly

There is a risk of an accident.

Continue to drive carefully and be ready to brake, in particular when warned to do so by DISTRONIC PLUS.

### WARNING

DISTRONIC PLUS brakes your vehicle with up to 40% of the maximum braking force. If this braking force is insufficient, DISTRONIC PLUS warns you visually and audibly. There is a risk of an accident.

In such cases, apply the brakes yourself and try to take evasive action.

If you fail to adapt your driving style, DISTRONIC PLUS can neither reduce the risk of an accident nor override the laws of physics. DISTRONIC PLUS cannot take account of road, weather and traffic conditions. DISTRONIC PLUS is only an aid. You are responsible for maintaining a safe distance to the vehicle in front, for vehicle speed, for braking in good time and for staying in lane.

Do not use DISTRONIC PLUS:

- in road and traffic conditions that do not allow you to maintain a constant speed, e.g. in heavy traffic or on winding roads
- on slippery road surfaces. Braking or accelerating can cause the drive wheels to lose traction and the vehicle could then skid
- when there is poor visibility, e.g. due to fog, heavy rain or snow

DISTRONIC PLUS may not detect narrow vehicles driving in front, e.g. motorcycles, or vehicles driving on a different line.

In particular, the detection of obstacles can be impaired if:

- there is dirt on the sensors or anything else covering the sensors
- there is snow or heavy rain
- there is interference by other radar sources
- there are strong radar reflections, for example, in parking garages

If DISTRONIC PLUS no longer detects a vehicle in front, DISTRONIC PLUS may unexpectedly accelerate the vehicle to the stored speed.

This speed may:

- be too high if you are driving in a filter lane or an exit lane
- be so high in the right lane that you pass vehicles driving on the left (left-hand drive countries)
- be so high in the left lane that you pass vehicles driving on the right (right-hand drive countries)

If there is a change of drivers, advise the new driver of the speed stored.

### Cruise control lever

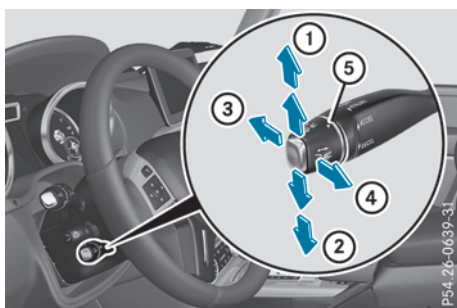

- ① Activates or increases speed
- ② Activates or reduces speed

- ③ Deactivates DISTRONIC PLUS
- ④ Activates at the current speed/last stored speed
- ⑤ Sets a specified minimum distance

When you activate DISTRONIC PLUS, the stored speed appears in the multifunction display for five seconds.

**Speedometer with segments:** when DISTRONIC PLUS is activated, the segments from the stored speed to the end of the scale light up.

### Activating DISTRONIC PLUS

#### Activation conditions

In order to activate DISTRONIC PLUS, the following conditions must be fulfilled:

- the engine must be started. It may take up to two minutes after pulling away before DISTRONIC PLUS is operational.
- the parking brake must be released.
- the differential lock must be disengaged.
- ESP® must be active, but not intervening.
- the automatic transmission is in position **D**.
- the driver's door must be closed or your seat belt must be fastened when you shift the transmission from position **P** to **D**.
- the front-passenger door and rear doors must be closed.
- the vehicle must not slide.
- the transfer case must be in the **HIGH RANGE** on-road position.
- the vehicle must not be on an uphill or downhill gradient of more than 22-25%.

#### Activating

- ▶ Briefly pull the cruise control lever towards you ④, up ① or down ②. DISTRONIC PLUS is activated.
- ▶ Remove your foot from the accelerator pedal. The vehicle adapts its speed to that of the vehicle in front, but only up to the desired stored speed.

If you do not fully release the accelerator pedal, the **DISTRONIC PLUS Passive** message appears in the multifunction display. The set distance to a slower-moving vehicle in front will then not be maintained. You will be driving at the speed you determine by the position of the accelerator pedal.

You can also activate DISTRONIC PLUS when stationary. The lowest speed that can be set is 20 mph (30 km/h).

- ▶ Briefly pull the cruise control lever towards you ④, up ① or down ②. DISTRONIC PLUS is activated.

### Activating at the current speed/last stored speed

#### WARNING

If you call up the stored speed and it differs from the current speed, the vehicle accelerates or decelerates. If you do not know the stored speed, the vehicle could accelerate or brake unexpectedly. There is a risk of an accident.

Pay attention to the road and traffic conditions before calling up the stored speed. If you do not know the stored speed, store the desired speed again.

- ▶ Briefly pull the cruise control lever towards you ④.
- ▶ Remove your foot from the accelerator pedal. DISTRONIC PLUS is activated. The first time it is activated, the current speed is stored. Otherwise, it sets the vehicle speed to the previously stored value.

## Driving with DISTRONIC PLUS

### Pulling away and driving

- ▶ **If you want to pull away with DISTRONIC PLUS:** remove your foot from the brake pedal.
- ▶ Briefly pull the cruise control lever towards you ④.

or

- ▶ Accelerate briefly.  
The vehicle pulls away and adapts its speed to that of the vehicle in front. If no vehicle is detected in front, your vehicle accelerates to the stored speed.

The vehicle can also pull away when it is facing an unidentified obstacle or is driving on a different line from another vehicle. The vehicle then brakes automatically.

If DISTRONIC PLUS does not detect a vehicle in front, the system operates like a cruise control.

If DISTRONIC PLUS detects that the vehicle in front is driving slower, your vehicle brakes. In

this way, the specified minimum distance you have selected is maintained.

If DISTRONIC PLUS detects a faster-moving vehicle in front, it increases the driving speed to the set speed.

If you depress the brake, DISTRONIC PLUS is deactivated unless your vehicle is stationary.

### Selecting the drive program

DISTRONIC PLUS supports a sporty driving style when you have selected the **S** driving program (> page 116). Acceleration behind the vehicle in front or to the set speed is then noticeably more dynamic. If you have selected drive program **E** or **C** (Mercedes-AMG vehicles), the vehicle accelerates more gently. This setting is recommended in stop-start traffic.

### Changing lanes

If you change to the passing lane, DISTRONIC PLUS supports you when:

- you are driving faster than 40 mph (60 km/h)
- DISTRONIC PLUS is maintaining the distance to a vehicle in front
- you switch on the appropriate turn signal
- DISTRONIC PLUS does not detect a danger of collision

If these conditions are fulfilled, your vehicle is accelerated. Acceleration will be interrupted if changing lanes takes too long or if the distance between your vehicle and the vehicle in front becomes too small.

When changing lanes, DISTRONIC PLUS monitors the left lane on left-hand drive vehicles and the right lane on right-hand drive vehicles.

### Stopping

#### WARNING

When leaving the vehicle, even if it is braked only by DISTRONIC PLUS, it could roll away if:

- there is a malfunction in the system or in the voltage supply.
- DISTRONIC PLUS has been deactivated with the cruise control lever, e.g. by a vehicle occupant or from outside the vehicle.
- the electrical system in the engine compartment, the battery or the fuses have been tampered with.

- the battery is disconnected.
- the accelerator pedal has been depressed, e.g. by a vehicle occupant.

There is a risk of an accident.

If you wish to exit the vehicle, always turn off DISTRONIC PLUS and secure the vehicle against rolling away.

For further information on deactivating DISTRONIC PLUS (▷ page 139).

If DISTRONIC PLUS detects that the vehicle in front is stopping, it brakes your vehicle until it is stationary.

Once your vehicle is stationary, it remains stationary and you do not need to depress the brake.

Depending on the specified minimum distance, your vehicle will come to a standstill at a sufficient distance behind the vehicle in front. The specified minimum distance is set using the control on the cruise control lever.

The automatic transmission shifts automatically to transmission position **P** if DISTRONIC PLUS is activated and:

- the driver's seat belt is not fastened and the driver's door is open.
- the engine is switched off, unless it is automatically switched off by the ECO start/stop function.

On steep uphill or downhill inclines, or if there is a malfunction, the automatic transmission may also automatically be shifted to position **P**.

### Setting a speed

- ▶ Push the cruise control lever upwards ① for a higher speed or down ② for a lower speed.

- ▶ **To adjust the set speed in 1 mph increments (1 km/h increments):** briefly push the cruise control lever up ① or down ② to the pressure point.

Every time the cruise control lever is pressed up ① or down ②, the last speed stored is increased or reduced.

- ▶ **To adjust the set speed in 5 mph increments (10 km/h increments):** briefly push the cruise control lever up ① or down ② beyond the pressure point.

Every time the cruise control lever is pressed up ① or down ②, the last speed stored is increased or reduced.

If you accelerate to overtake, DISTRONIC PLUS adjusts the vehicle's speed back to the last speed stored after you have finished overtaking.

### Setting a specified minimum distance

You can set the specified minimum distance for DISTRONIC PLUS by varying the time span between one and two seconds. With this function, you can set the minimum distance that DISTRONIC PLUS keeps to the vehicle in front, dependent on vehicle speed. You can see this distance in the multifunction display (▷ page 167).

Make sure that you maintain the minimum distance to the vehicle in front as required by law. Adjust the distance to the vehicle in front if necessary.

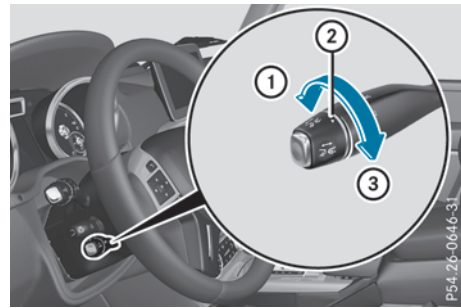

- ▶ **To increase:** turn control ② in direction ③. DISTRONIC PLUS then maintains a greater distance between your vehicle and the vehicle in front.

- ▶ **To decrease:** turn control ② in direction ①. DISTRONIC PLUS then maintains a shorter distance between your vehicle and the vehicle in front.

## DISTRONIC PLUS displays in the instrument cluster

### Displays in the speedometer



When DISTRONIC PLUS is activated, one or two segments ② in the stored speed range light up in the speedometer.

If DISTRONIC PLUS detects a vehicle driving in front, segments between the speed of the vehicle in front ③ and stored speed ① light up in the speedometer.

For design reasons, the speed displayed in the speedometer may differ slightly from the speed set for DISTRONIC PLUS.

### Displays in the assistance graphic

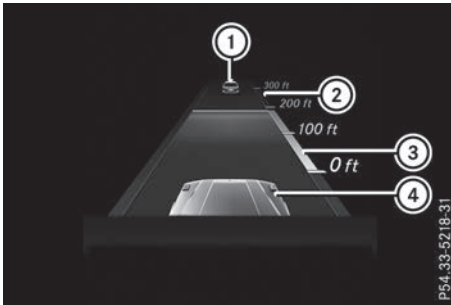

#### Display when DISTRONIC PLUS is deactivated

- ① Vehicle in front, if detected
- ② Distance indicator, current distance to the vehicle in front
- ③ Specified minimum distance to the vehicle in front; adjustable
- ④ Own vehicle

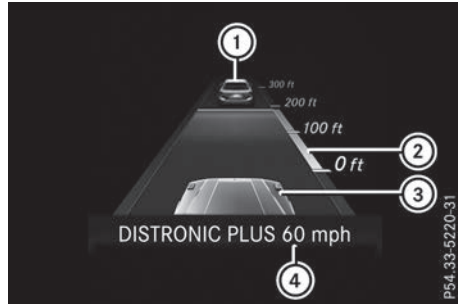

#### Display when DISTRONIC PLUS is activated

- ① Vehicle in front, if detected
- ② Specified minimum distance to the vehicle in front; adjustable
- ③ Own vehicle
- ④ DISTRONIC PLUS activated

You can select the [Assistance Graphic](#) function in the on-board computer assistance menu (▷ page 167).

### Deactivating DISTRONIC PLUS

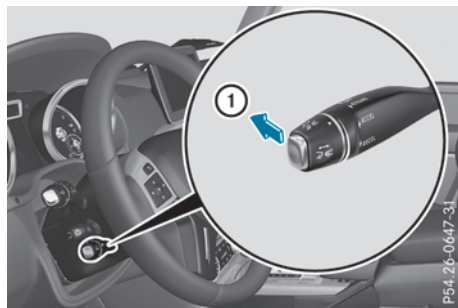

There are several ways to deactivate DISTRONIC PLUS:

- ▶ Briefly push the cruise control lever forward ①.

or

- ▶ Brake, unless the vehicle is stationary

When you deactivate DISTRONIC PLUS, the **DISTRONIC PLUS Off** message is shown in the multifunction display for approximately five seconds.

The last speed stored remains stored until you switch off the engine.

DISTRONIC PLUS is not deactivated if you depress the accelerator pedal.

DISTRONIC PLUS is automatically deactivated if:

- you apply the parking brake
- you are driving slower than 15 mph (25 km/h) and there is no vehicle in front, or if the vehicle in front is no longer detected
- ESP® intervenes or you deactivate ESP®
- the automatic transmission is in position **P**, **R** or **N**
- you pull the cruise control lever towards you in order to pull away and the front-passenger door or one of the rear doors is open
- the vehicle slips

If DISTRONIC PLUS is deactivated, an intermittent warning tone sounds and the **DISTRONIC PLUS Off** message appears in the multifunction display for approximately five seconds.

### Tips for driving with DISTRONIC PLUS

Pay particular attention in the following traffic situations:

- Cornering, entering and exiting a bend: the ability of DISTRONIC PLUS to detect vehicles when cornering is limited. Your vehicle may brake unexpectedly or late.
- Driving on a different line: DISTRONIC PLUS may not detect vehicles which are not driving in the middle of their lane. The distance to the vehicle in front will be too short.
- Other vehicles changing lane: DISTRONIC PLUS has not detected the vehicle cutting in yet. The distance to this vehicle will be too short.
- Narrow vehicles: DISTRONIC PLUS does not detect the vehicle in front on the edge of the road because of its narrow width. The distance to the vehicle in front will be too short.
- Obstacles and stationary vehicles: DISTRONIC PLUS does not brake for obstacles or stationary vehicles. If, for example, the detected vehicle turns a corner and reveals an obstacle or stationary vehicle, DISTRONIC PLUS will not brake for these.
- Crossing vehicles: DISTRONIC PLUS may mistakenly detect vehicles that are crossing your lane. Activating DISTRONIC PLUS at traffic lights with crossing traffic, for example, could cause your vehicle to pull away unintentionally.

In such situations, brake if necessary. DISTRONIC PLUS is then deactivated.

## Blind Spot Assist

### General notes

Blind Spot Assist monitors the areas on either side of the vehicle that are not visible to the driver with two lateral, rear-facing radar sensors. A warning lamp lights up in the exterior mirrors and draws your attention to vehicles detected in the monitored area. If you then switch on the corresponding turn signal to change lane, you will also receive an optical and audible warning.

Blind Spot Assist supports you from a speed of approximately 20 mph (30 km/h).

### Important safety notes

#### WARNING

Blind Spot Assist does not react to:

- vehicles overtaken too closely on the side, placing them in the blind spot area
- vehicles which approach with a large speed differential and overtake your vehicle

As a result, Blind Spot Assist may not give warnings in such situations. There is a risk of an accident.

Always observe the traffic conditions carefully, and maintain a safe lateral distance.

Blind Spot Assist is only an aid. It may fail to detect some vehicles and is no substitute for attentive driving. Always ensure that there is sufficient distance to the side for other road users and obstacles.

#### USA only:

This device has been approved by the FCC as a "Vehicular Radar System". The radar sensor is intended for use in an automotive radar system only. Removing, tampering with, or altering the device will void any warranties, and is not permitted by the FCC. Do not tamper with, alter, or use in any non-approved way.

Any unauthorized modification to this device could void the user's authority to operate the equipment.

## Radar sensors

The radar sensors for Blind Spot Assist are integrated into the rear bumper. Make sure that the bumpers are free from dirt, ice or slush. The sensors must not be covered, for example by cycle racks or overhanging loads. Following a severe impact or in the event of damage to the bumpers, have the function of the radar sensors checked at a qualified specialist workshop. Blind Spot Assist may no longer work properly.

## Monitoring area

In particular, the detection of obstacles can be impaired if:

- there is dirt on the sensors or anything else covering the sensors
- there is poor visibility, e.g. due to fog, heavy rain, snow or spray
- there are narrow vehicles, e.g. motorcycles or bicycles
- the road has very wide lanes
- the road has narrow lanes
- you are not driving in the middle of the lane
- there are barriers or other road boundaries

Vehicles in the monitoring range are then not indicated.

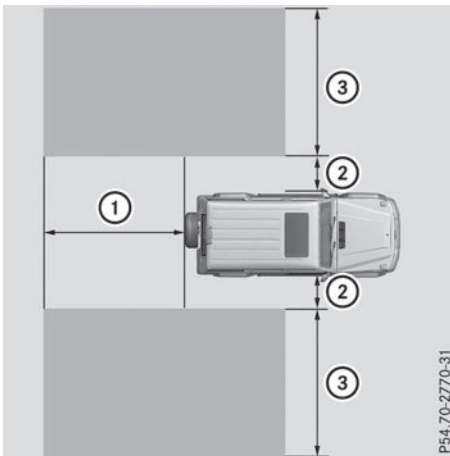

At a distance of around 1.6 ft (0.5 m) ② from the vehicle, Blind Spot Assist monitors the area up to 10 ft (3 m) next to ③ and behind ① your vehicle, as shown in the picture.

If the lanes are narrow, vehicles driving in the lane beyond the lane next to your vehicle may be

indicated, especially if the vehicles are not driving in the middle of their lane. This may be the case if the vehicles are driving on the inner side of their lane.

Due to the nature of the system:

- warnings may be issued in error when driving close to crash barriers or similar solid lane borders
- warnings may be interrupted when driving alongside long vehicles, e.g. trucks, for a prolonged time

## Indicator and warning lamp

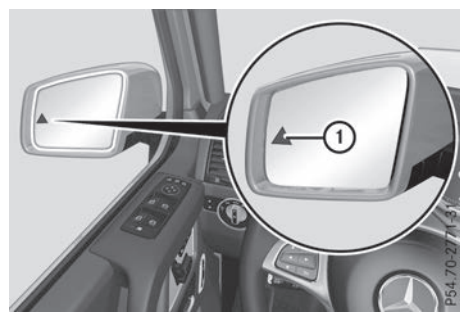

### ① Yellow indicator lamp/red warning lamp

When Blind Spot Assist is activated, indicator lamp ① in the exterior mirrors lights up yellow at speeds of up to 20 mph (30 km/h). At speeds above 20 mph (30 km/h), the indicator lamp goes out and Blind Spot Assist is operational.

If a vehicle is detected within the monitoring range of Blind Spot Assist at speeds above 20 mph (30 km/h), warning lamp ① on the corresponding side lights up red. This warning occurs when a vehicle enters the blind spot monitoring range from behind or from the side. When you overtake a vehicle, the warning only occurs as long as the difference in speed is less than 7 mph (12 km/h).

The yellow indicator lamp goes out if reverse gear is engaged. In this event, Blind Spot Assist is no longer active.

The brightness of the indicator/warning lamps is adjusted automatically depending on the ambient light.

### Collision warning

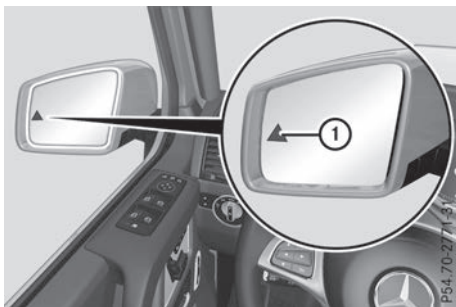

#### ① Yellow indicator lamp/red warning lamp

If a vehicle is detected in the monitoring range of Blind Spot Assist and you switch on the corresponding turn signal, a double warning tone sounds. Red warning lamp ① flashes. If the turn signal remains on, detected vehicles are indicated by the flashing of red warning lamp ①. There are no further warning tones.

### Activating Blind Spot Assist

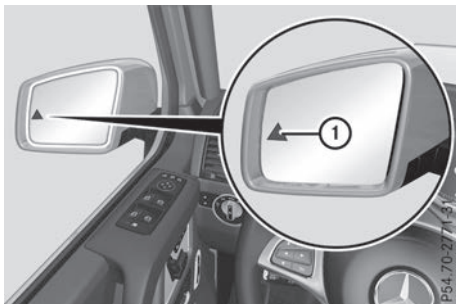

#### ① Yellow indicator lamp/red warning lamp

- ▶ Make sure that Blind Spot Assist is activated in the on-board computer (▷ page 167).
- ▶ Turn the SmartKey to position ② in the ignition lock.  
Warning lamps ① in the exterior mirrors light up red for approximately 1.5 seconds and then turn yellow.

### HOLD function

#### General notes

The HOLD function can assist the driver in the following situations:

- when pulling away, especially on steep slopes
- when maneuvering on steep slopes
- when waiting in traffic

The vehicle is kept stationary without the driver having to depress the brake pedal.

The braking effect is canceled and the HOLD function deactivated when you depress the accelerator pedal to pull away.

Do not use the HOLD function when driving off-road, on steep uphill or downhill gradients or on slippery or loose surfaces. The HOLD function cannot hold the vehicle on such surfaces.

#### Important safety notes

#### WARNING

If the vehicle is only braked using the HOLD function, the vehicle may roll away in the following situations when you leave the vehicle:

- if there is a malfunction in the system or in the voltage supply
- if the HOLD function is deactivated by depressing the accelerator pedal or brake pedal, e.g. by a vehicle occupant
- if the electrical system in the engine compartment, the battery or the fuses are tampered with or the battery is disconnected

There is a risk of an accident.

Always deactivate the HOLD function and secure the vehicle against rolling away before you leave it.

**!** When DISTRONIC PLUS or the HOLD function is activated, the vehicle brakes automatically in certain situations.

To avoid damage to the vehicle, deactivate DISTRONIC PLUS and the HOLD function in the following or similar situations:

- when towing the vehicle
- in the car wash

Deactivating the HOLD function (▷ page 143).



### Activation conditions

You can activate the HOLD function if:

- the vehicle is stationary
- the engine is running or if it has been automatically switched off by the ECO start/stop function
- the driver's door is closed or your seat belt is fastened
- the parking brake is released
- the transmission is in position **D**, **R** or **N**
- DISTRONIC PLUS is deactivated

### Activating the HOLD function

- ▶ Make sure that the activation conditions are met.
- ▶ Depress the brake pedal.
- ▶ Quickly depress the brake pedal further until **HOLD** appears in the multifunction display. The HOLD function is activated. You can release the brake pedal.

If depressing the brake pedal the first time does not activate the HOLD function, wait briefly and then try again.

### Deactivating the HOLD function

The HOLD function is deactivated automatically if:

- you depress the accelerator and the transmission is in position **D** or **R**
- the transmission is in position **P**
- you depress the brake pedal again with a certain amount of pressure until **HOLD** disappears from the multifunction display
- you activate DISTRONIC PLUS

On steep uphill or downhill inclines or if there is a malfunction, the transmission may also be automatically shifted into position **P**.

### Permanent all-wheel drive

- ❗ Never tow the vehicle with one axle raised. This may damage the transfer case. Damage of this sort is not covered by the Mercedes-Benz Limited Warranty. All wheels must remain either on the ground or be fully raised. Observe the instructions for towing the vehicle with all wheels in full contact with the ground.

- ❗ When testing the parking brake, only operate the vehicle briefly (for a maximum of ten seconds) on a brake dynamometer. Turn the SmartKey to position **0** or **1** in the ignition lock. You could otherwise damage the drive train or the brake system.

- ❗ A function or performance test should only be carried out on a two-axle dynamometer. Before you operate the vehicle on such a dynamometer, please consult a qualified workshop. You could otherwise damage the drive train or the brake system.

The all-wheel drive system ensures that all four wheels are permanently driven. The all-wheel drive system improves vehicle traction together with ESP® and 4ETS if a drive wheel spins due to insufficient grip.

If a drive wheel spins due to insufficient grip:

- Only depress the accelerator pedal as far as necessary when pulling away.
- Take your foot off the accelerator, slowly, while the vehicle is in motion.

In wintry driving conditions, always use winter tires (M+S tires) and if necessary, snow chains (▷ page 259). Only in this way can the maximum effect of all-wheel drive be achieved.

For information on driving off-road, see (▷ page 129).

## PARKTRONIC

### Important safety notes

PARKTRONIC is an electronic parking aid with ultrasonic sensors. It monitors the area around your vehicle using six sensors in the front bumper and four sensors in the rear bumper. PARKTRONIC indicates visually and audibly the distance between your vehicle and an object. PARKTRONIC is only an aid. It is not a replacement for your attention to your immediate surroundings. You are always responsible for safe maneuvering, parking and exiting a parking space. Make sure that there are no persons, animals or objects in the maneuvering area while maneuvering and parking in/leaving parking spaces.

- ❗ When parking, pay particular attention to objects above or below the sensors, such as flower pots or trailer drawbars. PARKTRONIC does not detect such objects when they are in

the immediate vicinity of the vehicle. You could damage the vehicle or the objects.

The sensors may not detect snow and other objects that absorb ultrasonic waves.

Ultrasonic sources such as an automatic car wash, the compressed-air brakes on a truck or a pneumatic drill could cause PARKTRONIC to malfunction.

PARKTRONIC may not function correctly on uneven terrain.

PARKTRONIC is activated automatically when you:

- switch on the ignition
- shift the transmission to position **D**, **R** or **N**
- release the parking brake

PARKTRONIC is deactivated at speeds above 11 mph (18 km/h). It is reactivated at lower speeds.

### Range of the sensors

PARKTRONIC does not take objects into consideration that are:

- below the detection range, e.g. people, animals or objects.
- above the detection range, e.g. overhanging loads, tail sections or loading ramps of goods vehicles

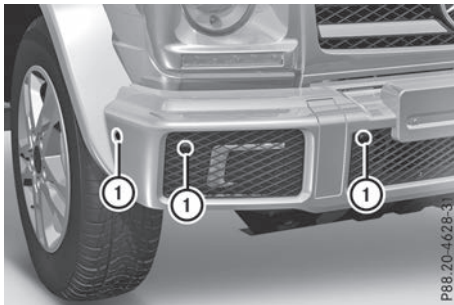

- ① Example: sensors in the front bumper, right-hand side

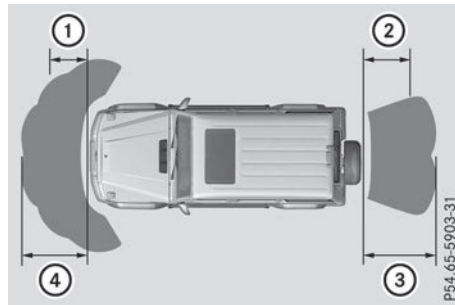
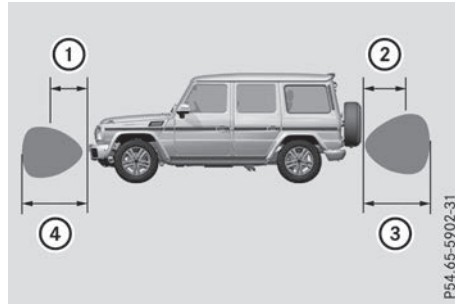

- ① Approx. 24 in (approx. 60 cm) (corners)  
 ② Approx. 32 in (approx. 80 cm) (corners)  
 ③ Approx. 35 in (approx. 90 cm) (center)  
 ④ Approx. 40 in (approx. 100 cm) (center)

The sensors must be free from dirt, ice or slush. They can otherwise not function correctly. Clean the sensors regularly, taking care not to scratch or damage them (▷ page 239).

Minimum distance

Center	Approx. 8 in (approx. 20 cm)
Corners	Approx. 8 in (approx. 20 cm)

If there is an obstacle within this range, the relevant warning displays light up and a warning tone sounds. If the distance falls below the minimum, the distance may no longer be shown.

### Warning displays

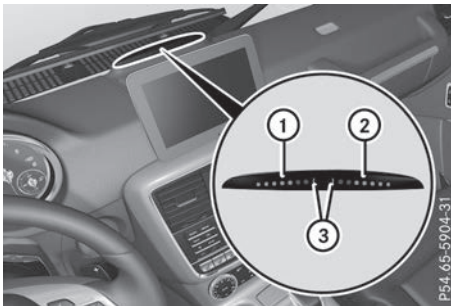

Warning display for the front area

- ① Segments on the left-hand side of the vehicle
- ② Segments on the right-hand side of the vehicle
- ③ Segments showing operational readiness

The warning displays show the distance between the sensors and the obstacle. The warning display for the front area is located on the dashboard above the center air vents. The warning display for the rear area is located on the headliner in the rear compartment.

The warning display for each side of the vehicle is divided into five yellow and two red segments. PARKTRONIC is operational if yellow segments showing operational readiness ③ light up.

The selected transmission position and the direction in which the vehicle is rolling determine which warning display is active when the engine is running.

Transmission position	Warning display
<b>D</b>	Front area activated
<b>R</b> , <b>N</b> or the vehicle is rolling backwards	Rear and front areas activated
<b>P</b>	No areas activated

One or more segments light up as the vehicle approaches an obstacle, depending on the vehicle's distance from the obstacle.

From the:

- sixth segment onwards, you will hear an intermittent warning tone for approximately two seconds.
- seventh segment onwards, you will hear a warning tone for approximately two seconds. This indicates that you have now reached the minimum distance.

### Deactivating/activating PARKTRONIC

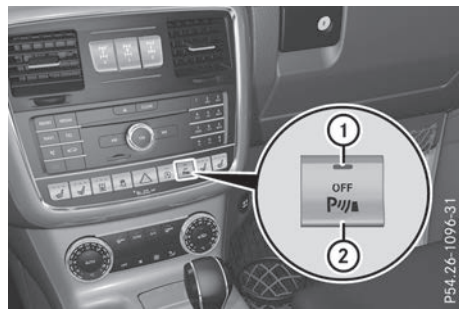

- ① Indicator lamp
- ② Deactivates/activates PARKTRONIC

If indicator lamp ① lights up, PARKTRONIC is deactivated.

- i** PARKTRONIC is automatically activated when you turn the SmartKey to position ② in the ignition lock.

### Towing a trailer

PARKTRONIC is deactivated for the rear area when you establish an electrical connection between your vehicle and a trailer.

## Problems with PARKTRONIC

Problem	Possible causes/consequences and ► Solutions
Only the red segments in the PARKTRONIC warning displays are lit. You also hear a warning tone for approximately two seconds. PARKTRONIC is deactivated after a few seconds, and the indicator lamp in the PARKTRONIC button lights up.	PARKTRONIC has malfunctioned and has switched off. ► If problems persist, have PARKTRONIC checked at a qualified specialist workshop.
Only the red segments in the PARKTRONIC warning displays are lit. PARKTRONIC is deactivated after a few seconds.	The PARKTRONIC sensors are dirty or there is interference. ► Clean the PARKTRONIC sensors (▷ page 239). ► Switch the ignition back on.  The problem may be caused by an external source of radio or ultrasound waves. ► See if PARKTRONIC functions in a different location.

## Rear view camera

## General notes

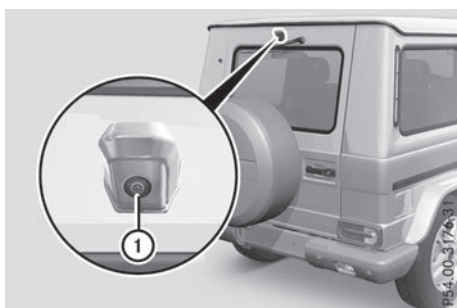

Rear view camera ① is an optical parking and maneuvering aid. It shows the area behind the vehicle with guide lines in the multimedia system.

The area behind the vehicle is displayed as a mirror image, as in the rear view mirror.

**i** The text shown in the multimedia system depends on the language setting. The following are examples of rear view camera displays in the multimedia system.

## Important safety notes

The rear view camera is only an aid. It is not a replacement for your attention to your immediate surroundings. You are always responsible for safe maneuvering and parking. Make sure that there are no persons, animals or objects in the maneuvering area while maneuvering and parking in parking spaces.

Under the following circumstances, the rear view camera will not function, or will function in a limited manner:

- the rear door is open
- in heavy rain, snow or fog
- at night or in very dark places
- if the camera is exposed to very bright light
- if the area is lit by fluorescent bulbs or LED lighting (the display may flicker)
- if there is a sudden change in temperature, e.g. when driving into a heated garage in winter
- if the camera lens is dirty or obstructed. Observe the notes on cleaning (▷ page 240)
- if the rear of your vehicle is damaged. In this case, have the camera position and setting checked at a qualified specialist workshop

The field of vision and other functions of the rear view camera may be restricted due to additional accessories on the rear of the vehicle (e.g. license plate holder, bicycle rack).

### Activating/deactivating the rear view camera

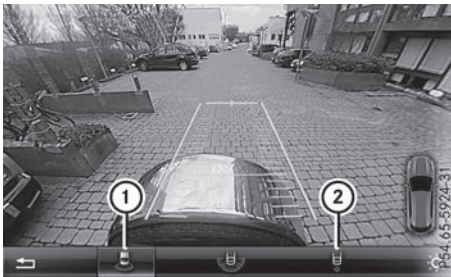

- ▶ **To activate:** make sure that the SmartKey is in position **2** in the ignition lock.
- ▶ Make sure that the "Rear view camera" function is selected in the multimedia system (see Digital Operator's Manual).
- ▶ Engage reverse gear.

The multimedia system shows the area behind the vehicle with guide lines. Symbol **1** indicates that the "reverse parking" function is active.

The image from the rear view camera is available throughout the maneuvering process.

- ▶ **To switch the function mode for vehicles with trailer tow hitch:** using the controller, select symbol **2** for "Coupling up a trailer". Symbol **2** is highlighted.

**To deactivate:** the rear view camera deactivates if you shift the transmission to position **P** or after driving forwards a short distance.

### Displays in the multimedia system

The rear view camera may show a distorted view of obstacles, show them incorrectly or not at all. The rear view camera does not show objects in the following positions:

- very close to the rear bumper
- under the rear bumper

**!** Objects that are not at ground level appear further away than they actually are, e.g.:

- the bumper of a parked vehicle
- the drawbar of a trailer

- the rear end of a truck
- a post sticking up at an angle

Use the guide lines for orientation only. Do not cross the lower guide line when approaching objects.

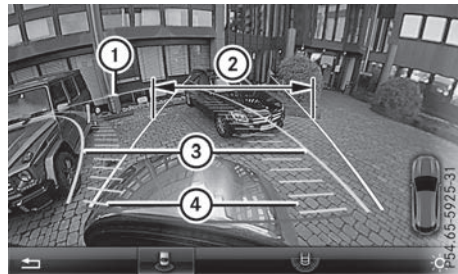

- 1** Yellow guide line at a distance of approximately 13 ft (4.0 m) from the rear of the vehicle
- 2** White guide line without steering input – vehicle width including the exterior mirrors (static)
- 3** Yellow guide line for the vehicle width including the exterior mirrors, for current steering wheel angle (dynamic)
- 4** Yellow lane marking the course the tires will take at the current steering wheel angle (dynamic)

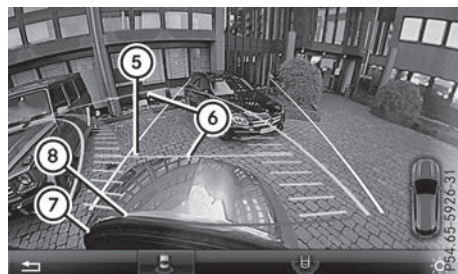

- 5** Yellow guide line at a distance of approximately 3 ft (1.0 m) from the rear of the vehicle
- 6** Vehicle center axle (marker assistance)
- 7** Spare wheel
- 8** Red guide line at a distance of approximately 12 in (0.30 m) from the rear of the vehicle

When the transmission is shifted to position **R**, guide lines appear in the camera image.

The distance specifications only apply to objects that are at ground level.

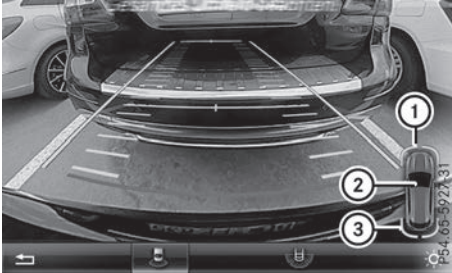

- ① Front warning display
- ② Additional vehicle icon: PARKTRONIC measurement operational readiness indicator
- ③ Rear warning display

Vehicles with PARKTRONIC: when PARKTRONIC is operational (▷ page 144), additional measurement operational readiness indicator ② appears in the multimedia system. If the PARKTRONIC warning displays are active or light up, warning displays ① and ③ are also active or light up correspondingly in the multimedia system.

### "Coupling up a trailer" function

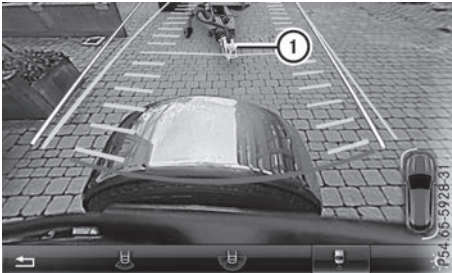

- ① Trailer drawbar

This function is only available on vehicles with a trailer tow hitch.

- ▶ Before coupling up a trailer, set the height of trailer drawbar ① so that it is slightly higher than the ball coupling.
- ▶ Position the vehicle centrally in front of trailer drawbar ①.

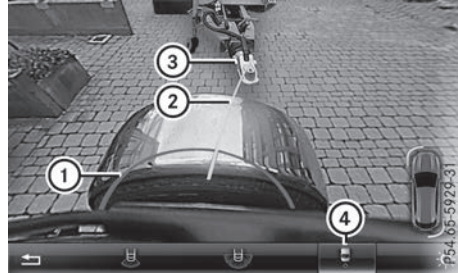

- ① Red guide line at a distance of approximately 12 in (0.30 m) from the ball coupling
- ② Trailer drawbar marker assistant
- ③ Trailer drawbar
- ④ Symbol for the "Coupling up a trailer" function

**i** The trailer tow hitch is not visible in the multimedia system display, as the spare tire covers the ball coupling of the trailer tow hitch.

- ▶ Select symbol ④ using the controller. The "Coupling up a trailer" function is selected. The distance specifications now only apply to objects that are at the same level as the ball coupling.
- ▶ Reverse carefully, making sure that trailer drawbar locating aid ② points approximately in the direction of trailer drawbar ③.
- ▶ Reverse carefully until trailer drawbar ③ reaches red guide line ①. **Do not drive any further.**  
The distance between trailer drawbar ③ and red guide line ① is now approximately 12 in (0.30 m).
- ▶ Couple up the trailer (▷ page 154).

### 180° view

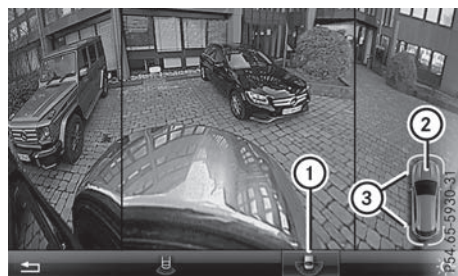

- ① Symbol for the 180° view function
- ② Your vehicle
- ③ PARKTRONIC warning displays

You can also use the rear view camera to select a 180° view.

When PARKTRONIC is operational (▷ page 144), a symbol for your own vehicle appears in the multimedia system. If the PARKTRONIC warning displays are active, warning displays ③ light up in the multimedia system in yellow or red accordingly.

## Off-road driving systems

### Transfer case

#### General notes

The vehicle has permanent all-wheel drive. The front and rear axles are constantly driven.

For further information on driving off-road, see (▷ page 129).

#### Shift ranges

<b>HIGH RANGE</b>	Position for all normal on-road driving conditions
<b>LOW RANGE</b>	Off-road gear for driving off-road. Also for use on steep uphill or downhill gradients, especially when towing a trailer. The vehicle travels around half the speed of on-road driving range <b>HIGH RANGE</b> . The tractive power is correspondingly higher.

#### Shifting the transfer case

##### General notes

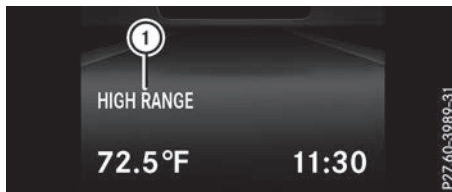

① Current shift range



- ① Indicator lamp
- ② LOW RANGE button

#### Important safety notes

##### ⚠ WARNING

If you do not wait for the transfer case gear change process to complete, the transfer case could remain in the neutral position. The power transmission to the driven wheels is then interrupted. There is a danger of the vehicle rolling away unintentionally. There is a risk of an accident.

Wait until the transfer case shift process is completed.

Do not switch off the engine while changing gear and do not shift the automatic transmission to another gear.

Always wait for the gear change process from **HIGH RANGE** to **LOW RANGE** and from **LOW RANGE** to **HIGH RANGE** to complete.

#### Switching on the off-road gear ratio

⚠ Proceed with the shifting process only when:

- the engine is running
- the vehicle is rolling
- the automatic transmission is in selector lever position **N**
- you are not driving faster than 25 mph (40 km/h)

You could otherwise damage the transfer case.

- ▶ Make sure the ECO start/stop function is switched off (▷ page 108).
- ▶ Press LOW RANGE button ②. Once the shifting procedure has been completed, the **LOW RANGE** transfer case position is shown in the multifunction display. Indicator lamp ① lights up.
- ▶ Shift the automatic transmission to position **D**.

### Switching off the off-road gear ratio

#### WARNING

If you do not wait for the transfer case gear change process to complete, the transfer case could remain in the neutral position. The power transmission to the driven wheels is then interrupted. There is a danger of the vehicle rolling away unintentionally. There is a risk of an accident.

Wait until the transfer case shift process is completed.

- ! Proceed with the shifting process only when:
  - the engine is running
  - the vehicle is rolling
  - the automatic transmission is in selector lever position **N**
  - you are not driving faster than 43 mph (70 km/h)
 You could otherwise damage the transfer case.

- ▶ Press button ②. Once the shifting procedure has been completed, the **HIGH RANGE** transfer case position is shown in the multifunction display. Indicator lamp ① goes out.

If the shifting procedure is unsuccessful, the multifunction display may show the following messages:

- **TC Shift Conditions Not Fulfilled**  
You have not met one or more shift conditions.
- **TC NEUTRAL On**  
The transfer case has canceled the shifting procedure and is in **Neutral**.
- **TC Shift Canceled**

The transfer case has canceled the gear change process.

- ▶ Carry out the gear change process again. Make sure to meet all conditions for changing gears.
  - **TC Malfunction Visit Workshop**  
There is a malfunction in the transfer case.
- ▶ Do not shift the transfer case.
- ▶ Have the vehicle checked as soon as possible at a qualified specialist workshop.

### Shifting to neutral

#### WARNING

If you do not wait for the transfer case gear change process to complete, the transfer case could remain in the neutral position. The power transmission to the driven wheels is then interrupted. There is a danger of the vehicle rolling away unintentionally. There is a risk of an accident.

Wait until the transfer case shift process is completed.

- ▶ Turn the SmartKey to position **2** in the ignition lock.
- ▶ Apply the parking brake.
- ▶ Depress the brake pedal.
- ▶ Shift the automatic transmission to position **N**.
- ▶ Press and hold LOW RANGE button ② for approximately ten seconds. When the shift procedure is complete, the multifunction display shows the **TC NEUTRAL On** message for five seconds.

If the shifting procedure is unsuccessful, the multifunction display may show the following messages (▷ page 183).

If the transfer case is in **Neutral**, the SmartKey is in the ignition lock and you open the driver's door, the **TC NEUTRAL On** message appears in the multifunction display. If you then release the parking brake, a warning tone will sound.



## Differential locks

### General notes

#### WARNING

When the differential locks are engaged, ABS, 4ETS, ESP® and BAS are deactivated. As a result, the wheels could lock when braking and the braking distance is increased. There is a risk of an accident.

Disengage the differential locks immediately on firm surfaces with good grip.

**!** In order to avoid damage to the transfer case, you must operate the vehicle on a dynamometer (1-axle dynamometer) only if:

- the axle not driven on is jacked up  
or
- the corresponding propeller shaft is disconnected and the transfer case differential lock is engaged.

Differential locks improve the traction of the vehicle.

Your vehicle is equipped with a differential lock each for:

- the transfer case: this controls the balance between the front and rear axles.
- the rear axle: this controls the balance between the wheels on the rear axle.
- the front axle: this controls the balance between the wheels on the front axle.

### Information on differential gear system and differential lock

When the vehicle drives around a curve, the wheels on the outside of the curve must cover a greater distance. Therefore, the wheels turn more rapidly than on the inside. The differential, a gear system in the drive train, allows for differing rotational speeds and facilitates cornering.

The disadvantage of a differential is that the wheels that have the least grip, get the most drive. For example, a wheel on a drive axle lies on snow-covered ground and therefore has no traction. The differential sends most of the drive force to this wheel because the force takes the route of the lowest resistance. The opposite wheel on this axle, however, which stands on firm ground and could therefore allow propul-

sion, receives no driving power. 4ETS compensates for this disadvantage. 4ETS provides good steerability by automatically braking the spinning wheel. 4ETS provides the wheel on the firm surface with more drive force, which in turn provides propulsion.

ESP® and 4ETS are traction systems that are ideal for road driving and suitable for light off-road driving. The **LOW RANGE** off-road gear also improves off-road capability.

More challenging off-road conditions require additional measures such as locking one or more differential.

Your vehicle is equipped with three differential locks:

- for the transfer case
- for the front axle
- for the rear axle

Each differential lock can be engaged with the corresponding switch on the center console. If the differential in the transfer case is locked, the front and rear wheels rotate at the same speed. If the differential for the rear axle is locked, both rear wheels rotate at the same speed, regardless of their respective torque. Note, engaging the differential lock greatly impairs the vehicle's steerability.

Note, it is imperative to use the differential function when driving on firm road surfaces. Under no circumstances should the differential be locked when driving on firm road surfaces. Otherwise, the vehicle may not be steerable and you could lose control of the vehicle. Therefore, only engage the differential lock when driving off-road. You should only engage the differential lock if activating 4ETS and ESP® driving systems and **LOW RANGE** off-road gear prove to be insufficient.

### Engaging the differential locks

#### General notes

The switches are located on the center console.

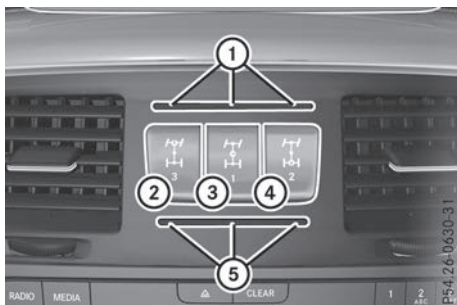

- ① Function indicator lamps (red)
- ② Differential lock for the front axle
- ③ Differential lock for the transfer case
- ④ Differential lock for the rear axle
- ⑤ Activation indicator lamps (yellow)

Engage the differential locks:

- off-road
- to deactivate ABS, 4ETS, ESP® and BAS while off-road
- when fording

For further information on driving off-road, see (> page 129).

You can engage the differential locks in the following order: ③, ④, ②.

### Important safety notes

#### WARNING

When differential locks are engaged on a firm, high-grip surface, the vehicle's steerability is greatly impaired. In particular, engaging the differential locks when cornering could lead to you losing control of the vehicle. There is a risk of an accident.

Disengage the differential locks immediately on firm surfaces with good grip.

#### WARNING

When the differential locks are engaged, ABS, 4ETS, ESP® and BAS are deactivated. As a result, the wheels could lock when braking and the braking distance is increased. There is a risk of an accident.

Disengage the differential locks immediately on firm surfaces with good grip.

**!** Only engage the differential locks when:

- you are driving at walking pace
- the drive wheels are not spinning
- you are not driving on a firm road surface

### Differential lock for the transfer case

► **To engage:** switch the transfer case to the **LOW RANGE** off-road driving position (> page 149).

► Press switch ③.



If the transfer case is in the **LOW RANGE** off-road position, the yellow activation indicator lamp under switch ③ lights up.

The  warning lamp in the instrument cluster lights up.

If the differential is locked, the red function indicator lamp above switch ③ lights up.

In the multifunction display you see the:

[Differential Locks Active ABS and ESP Not Available](#)

The    warning lamps light up in the instrument cluster.

The differential lock for the transfer case is engaged.

4ETS, ESP®, BAS and ABS are deactivated.

The vehicle's ability to steer is severely restricted. Drive carefully and accelerate gently for optimum traction.

You can now engage the differential lock for rear axle ④ and the differential lock for front axle ② as required.

### Differential lock for the rear axle

► **To engage:** press switch ④.

Yellow activation indicator lamp ⑤ lights up first, followed by red function indicator lamp ① of switch ④.

The differential lock for the rear axle is engaged.

### Differential lock for the front axle

► **To engage:** press switch ②.

First, the yellow activation indicator lamp lights up, followed by the red function indicator lamp.

The differential lock for the front axle is engaged.

## Disengaging the differential locks



You can disengage the differential locks in the following order: ②, ④, ③.

► **To simultaneously disengage all differential locks:** press switch ③.

Yellow activation indicator lamps ⑤ and red function indicator lamps ① go out.

After approximately three seconds of normal driving, ABS, 4ETS, ESP® and BAS are activated.

The **Differential Locks Active ABS and ESP Not Available** message disappears in the multifunction display and the

   warning lamps in the instrument cluster go out.

► Shift the transfer case to the **HIGH RANGE** on-road position (> page 149).

If red function indicator lamps ① do not go out when disengaging the differential locks, stop the vehicle safely in accordance with the traffic conditions and then drive on. The load change can disengage the differential locks.

## Towing a trailer

### Important safety notes

#### WARNING

When the vehicle/trailer combination begins to lurch, you could lose control of it. The vehicle/trailer combination could even rollover. There is a risk of an accident.

On no account should you attempt to straighten up the vehicle/trailer combination by increasing the speed. Reduce vehicle speed and do not countersteer. Apply the brake as necessary.

#### WARNING

If you install a ball coupling other than the one delivered with the vehicle, the trailer tow hitch and the rear axle may be overloaded. This applies especially if the ball coupling in question is longer or angled differently. This could seriously impair the driving characteristics and the trailer can come loose. There is a risk of an accident.

Only install the ball coupling delivered with the vehicle or a ball coupling that is designed to meet your trailer towing requirements. Do not modify the ball coupling or the trailer tow hitch.

#### WARNING

If the ball coupling is not installed correctly or not secured with the bolt provided and the corresponding spring cotter, the trailer may come loose. There is a risk of an accident.

Always install and secure the ball coupling as described. Before every journey, ensure that the ball coupling is secured with the bolt and the corresponding spring cotter.

! If you have a trailer tow hitch retrofitted, changes to the engine cooling system may be necessary, depending on the vehicle type.

If you have a trailer tow hitch retrofitted, observe the anchorage points on the chassis frame.

The installation of a trailer tow hitch is only permissible if a towing weight is specified in your vehicle documents. If this is not the case, then the vehicle is not approved for the towing of a trailer.

For more information, please contact a qualified specialist workshop.

Please observe the manufacturer's operating instructions for the trailer coupling if a detachable trailer coupling is used.

Exceeding the maximum permissible nose-weight of the trailer drawbar on the ball coupling may cause damage.

Damage may be caused to the following:

- Towing vehicle
- Trailer
- Ball coupling
- Trailer tow hitch

The vehicle/trailer combination could become unstable.

If the noseweight used is lower than the minimum permissible noseweight, the vehicle/trailer combination could also become unstable.

To avoid hazardous situations:

- make sure to check the noseweight before each journey
- use a drawbar noseweight as close as possible to the maximum noseweight
- do not exceed the maximum permissible noseweight
- the noseweight must not be lower than the minimum permissible noseweight

Make sure that the following values are not exceeded:

- the permissible trailer drawbar noseweight
- the permissible trailer load
- the permissible rear axle load of the towing vehicle
- the maximum permissible gross vehicle weight of both the towing vehicle and the trailer

When backing up the vehicle towards the trailer, make sure there is nobody between the trailer and the vehicle.

The applicable permissible values, which must not be exceeded, can be found:

- in your vehicle documents
- on the type plate for the trailer
- on the vehicle identification plate

If the values differ, the lowest value applies.

You will find the values approved by the manufacturer on the vehicle identification plates and those for the towing vehicle under "Technical data" (▷ page 291).

When backing up the vehicle towards the trailer, make sure there is nobody between the trailer and the vehicle.

Couple and uncouple the trailer carefully. If you do not couple the trailer to the towing vehicle correctly, the trailer could become detached.

When towing a trailer, your vehicle's handling characteristics will be different in comparison with when driving without a trailer.

The vehicle/trailer combination:

- is heavier
- is restricted in its acceleration and gradient-climbing capability
- has an increased braking distance
- is affected more by strong crosswinds
- demands more sensitive steering
- has a larger turning radius

This could impair the handling characteristics. Adapt your driving style accordingly. Maintain a safe distance. Drive carefully.

When towing a trailer, always adjust your speed to the current road and weather conditions. Do not exceed the maximum permissible speed for your vehicle/trailer combination.

### Notes on towing a trailer

#### General notes

- Do not exceed the maximum permissible speed for vehicle/trailer combinations in the relevant country.

This lowers the risk of an accident.

- Only install an approved trailer coupling on your vehicle.

Further information on availability and on installation is available from any authorized Mercedes-Benz Center.

- The bumpers of your vehicle are not suitable for installing detachable trailer couplings.
- Do not install hired trailer couplings or other detachable trailer couplings on the bumpers of your vehicle.
- If you do not need the ball coupling, remove the ball coupling from the ball coupling recess. This will reduce the risk of damage to the ball coupling.

When towing a trailer, set the tire pressure on the rear axle of the towing vehicle for the maximum load. Further information on the tire pressure table in the fuel filler flap (▷ page 120).

Please note that when towing a trailer, PARKTRONIC (▷ page 143) and Blind Spot Assist (▷ page 140) availability is limited or not available at all.

The height of the ball coupling changes with the load of the vehicle. If necessary, use a trailer with a height-adjustable drawbar.

You will find permissible trailer loads under "Technical data" (▷ page 291).

#### Driving tips

- ▶ Observe the notes on ESP® trailer stabilization (▷ page 61).
- ▶ On long and steep downhill gradients, select shift range **1**, **2** or **3** (▷ page 116) in good time.

This also applies if you have activated cruise control or the speed limiter.

- ▶ If necessary, shift the transfer case to **LOW RANGE** (▷ page 149).

This will use the braking effect of the engine, so that less braking will be required to maintain the speed. This relieves the load on the brake system and prevents the brakes from overheating and wearing too quickly. If you need additional braking, depress the brake pedal repeatedly rather than continuously.

The maximum permissible speed for vehicle/trailer combinations depends on the type of trailer. Before beginning the journey, check the trailer's documents to see what the maximum permitted speed is. Observe the maximum permissible speed in the relevant country.

For certain Mercedes-Benz vehicles, the maximum permissible rear axle load is increased when towing a trailer. See the "Technical data" section to find out whether this applies to your vehicle (▷ page 291). In the event of increased rear axle load, the car/trailer combination may not exceed a maximum speed of 60 mph (100 km/h) for reasons concerning the operating permit. This also applies in countries in which the maximum permissible speed for car/trailer combinations is greater than 60 mph (100 km/h).

When towing a trailer, your vehicle's handling characteristics will be different in comparison to when driving without a trailer and it will consume more fuel.

### Driving tips

- Maintain a greater distance from the vehicle in front than when driving without a trailer.
- Avoid braking abruptly. If possible, brake gently at first to allow the trailer to run on. Then, increase the braking force rapidly.
- The values given for gradient-climbing capabilities from a standstill refer to sea level. When driving in mountainous areas, note that the power output of the engine and, consequently, the vehicle's gradient-climbing capability, decreases with increasing altitude.

If the trailer swings from side to side:

- ▶ Do not accelerate.
- ▶ Do not counter-steer.
- ▶ Brake if necessary.

### Assembling the ball coupling

#### ⚠ WARNING

The ball coupling can be damaged if the nut on the ball coupling is tightened using the incorrect torque. As a result, the trailer may detach. There is a risk of an accident.

Immediately after installing, have the tightening torque checked at a qualified specialist workshop.

- ❗ Mercedes-Benz recommends that you only use ball couplings tested and approved for use on Mercedes-Benz vehicles. This helps to avoid damage to the vehicle.

Observe the manufacturer's installation instructions if you use a ball coupling other than the one supplied.

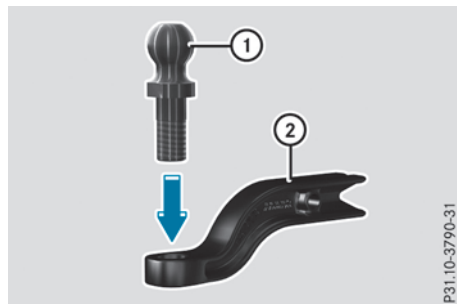

- ▶ Slide ball coupling ① through the hole in ball coupling carrier bar ② to the stop.

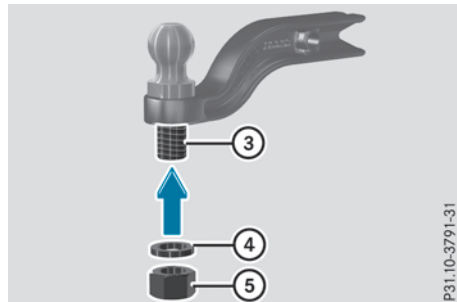

- ▶ Slide lock washer ④ onto the thread of ball coupling ③ to the stop.
- ▶ Screw on nut ⑤ as far as it will go.



P31.10-3792-31

- ▶ Using a torque wrench, tighten nut ⑥ with a torque of **516 lb-ft (700 Nm)**.
- ▶ Check that the length of overhanging thread ⑦ beneath nut ⑥ is at least **0.32 in (8 mm)**.
- ▶ Check that the assembled ball coupling has been assembled correctly.

Also observe the height of the trailer coupling and the trailer manufacturer's instructions.

Depending on the height of the trailer coupling, it may be necessary to rotate the ball coupling by 180° when assembling on the ball coupling carrier bar. The assembly process is identical.

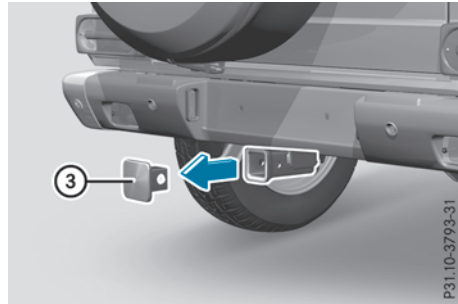

P31.10-3793-31

- ▶ Pull protective cap ③ in the direction of the arrow, out of the ball coupling recess.

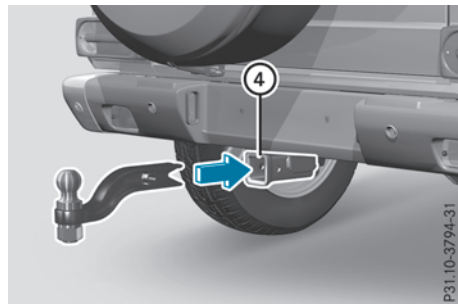

P31.10-3794-31

### Installing the ball coupling

#### ⚠ WARNING

If the ball coupling is not installed correctly or not secured with the bolt provided and the corresponding spring cotter, the trailer may come loose. There is a risk of an accident.

Always install and secure the ball coupling as described. Before every journey, ensure that the ball coupling is secured with the bolt and the corresponding spring cotter.

#### ⚠ WARNING

If the ball coupling is not correctly installed and secured, it can come loose during the journey and endanger other road users. There is a risk of an accident and injury.

Always install and secure the ball coupling as described. Before every journey, ensure that the ball coupling is secured with the bolt and the corresponding spring cotter.

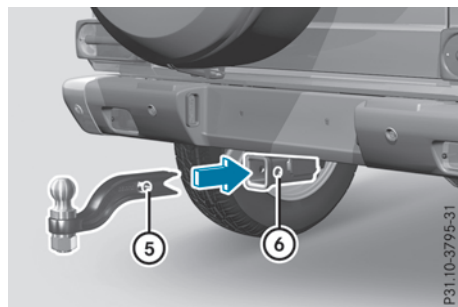

P31.10-3795-31

- ▶ Insert the ball coupling horizontally into ball coupling recess ④ in the direction of the arrow.
- ▶ Make sure that the hole in ball coupling ⑤ is in line with the hole in ball coupling recess ⑥.

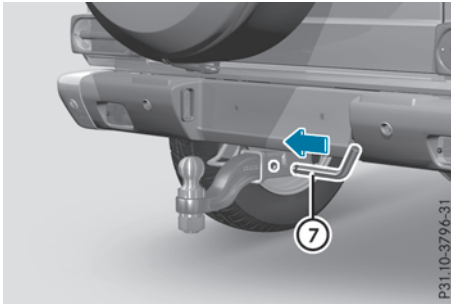

- ▶ Slide bolt ⑦ into the hole in the ball coupling recess and the ball coupling to the stop.

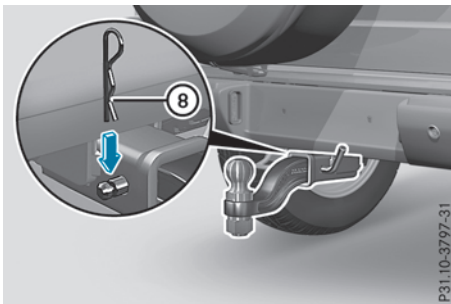

- ▶ Secure the bolt using spring cotter ⑧.

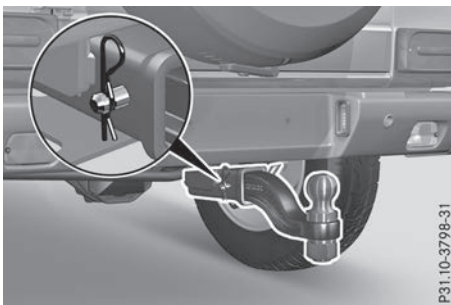

Correctly installed and secured ball coupling

- ▶ Check the ball coupling, bolt and spring cotter for correct installation.

### Coupling up a trailer

- ❗ Do not connect the trailer's brake system (if featured) to the hydraulic brake system of the towing vehicle, as the latter is equipped with an anti-lock brake system. Doing so will result in a loss of function of the brake systems of both the vehicle and the trailer.

Observe the maximum permissible trailer dimensions (width and length).

- ▶ Apply the vehicle's parking brake.
- ▶ Make sure that the automatic transmission is set to position **P**.
- ▶ Position the trailer horizontally behind the vehicle.
- ▶ Couple up the trailer.
- ▶ Establish the electrical connection between the vehicle and the trailer.
- ▶ Check that the trailer lighting system is working.
- ▶ Push the combination switch upwards/downwards and check whether the corresponding turn signal on the trailer flashes.

A trailer that is connected is recognized only when the electrical connection is established correctly and when the lighting system is working properly. The function of other systems also depends on this, for example:

- ESP®
- PARKTRONIC

These restrictions apply to accessories that are supplied with power via the trailer socket in your vehicle, e.g. a rear bicycle rack.

Observe the maximum permissible trailer dimensions (width and length).

Most U.S. states and all Canadian provinces require by law:

- Safety chains between the towing vehicle and the trailer. The chains should be cross-wound under the trailer drawbar. They must be fastened to the vehicle's trailer coupling, not to the bumper or the axle.

Leave enough play in the chains to make tight cornering possible.

- A separate brake system for certain types of trailer.
- Safety switch for braked trailers. Check the specific legal requirements applicable to your state.

If the trailer becomes detached from the towing vehicle, the safety feature brakes the trailer.

### Towing a trailer

There are several legal requirements for towing a trailer, e.g. the maximum permissible speed. Make sure that your car/trailer combination complies with the local regulations:

- in your place of residence
- at your destination

The police and local authorities can provide reliable information.

In order to accumulate driving experience and accustom yourself to the new handling characteristics, practice the following at a location where there is no traffic:

- Cornering
- Stopping
- Backing up

Before driving, check the following:

- Trailer tow hitch
- Safety switch for braked trailers
- Safety chains
- Electrical connections
- Lighting system
- Wheels and tires
- Load-securing measures

Adjust the exterior mirrors to provide an unobstructed view of the rear section of the trailer.

**Trailers with electronically controlled brakes:** pull away carefully in the vehicle/trailer combination, brake manually using the brake controller and check whether the brakes function correctly.

Check the load securing measures on a regular basis.

When towing a trailer, your vehicle's handling characteristics will be different in comparison with when driving without a trailer.

The vehicle/trailer combination:

- is heavier
- is restricted in its acceleration and gradient-climbing capability
- has an increased braking distance
- is affected more by strong crosswinds
- demands more sensitive steering
- has a larger turning radius

Avoid sudden steering movements.

Avoid braking abruptly. If possible, brake gently at first to allow the trailer to run on. Then, increase the braking force rapidly.

When overtaking, pay particular attention to the extended length of your vehicle/trailer combination.

Due to the length of the vehicle/trailer combination, you require additional road space when overtaking before you can change back to the original lane.

If the automatic transmission repeatedly shifts between gears on uphill or downhill gradients, shift to a lower gear.

Driving in a lower gear and at a reduced speed decreases the risk of engine damage.

Avoid constant braking. Otherwise, the vehicle brakes and possibly also the trailer brakes may overheat.

When driving downhill, shift to a lower gear to utilize the engine's braking effect.

If the coolant temperature increases dramatically while the air-conditioning system is switched on, switch off the air-conditioning system.

Coolant heat can also be dissipated by opening the windows and switching the ventilation blower and the interior temperature to the highest level.

### Decoupling a trailer

#### WARNING

If you uncouple a trailer with the overrun brake engaged, you could trap your hand between the vehicle and the trailer drawbar. There is a risk of injury.

Do not uncouple a trailer if the overrun brake is engaged.

**!** Do not disconnect a trailer with an engaged overrun brake. Otherwise, your vehicle could be damaged by the rebounding of the overrun brake.

- ▶ Apply the parking brake.
- ▶ Make sure that the automatic transmission is set to position **P**.
- ▶ Secure the vehicle and trailer against rolling away.
- ▶ Close all doors, including the rear door.
- ▶ Remove the trailer cable.
- ▶ Remove the safety chains, if there are any.
- ▶ Uncouple the trailer.



## Permissible trailer and drawbar loads

### Weight specifications

The gross trailer weight is calculated as the weight of the trailer plus the weight of the load and the trailer's equipment.

You will find permissible trailer loads under "Technical data" (▷ page 291).

### Loading a trailer

- When loading the trailer, make sure that neither the permissible gross trailer weight nor the permissible gross vehicle weight are exceeded. The permissible gross vehicle weight is indicated on the identification plate on the B-pillar on the driver's side of the vehicle.

You can find the maximum permissible values on the type plates of your vehicle and the trailer. When calculating how much weight the vehicle and trailer may carry, pay attention to the respective lowest values.

- The trailer drawbar load on the ball coupling must be added to the rear axle load to avoid exceeding the permissible gross axle weight. The permissible gross vehicle weight is indicated on the identification plate on the B-pillar on the driver's side of the vehicle.

Mercedes-Benz recommends a trailer load where the trailer drawbar noseweight accounts for 8% to 15% of the permissible gross trailer weight.

Additional accessories, passengers and load reduce the permissible trailer load and noseweight that your vehicle can tow.

### Checking the vehicle and trailer weight

- Have the towing vehicle, including the driver, passengers and load, and completely loaded trailer weighed on a suitable weighing machine. This will allow you to ensure that the weights of the towing vehicle and trailer comply with the maximum permissible values.
- Check the gross axle weight rating of the front and rear axles, the gross weight of the trailer and trailer drawbar load.

## Trailer power supply

- ! You can connect accessories with a maximum power consumption of 180 W to the permanent power supply.

You must not charge a trailer battery using the power supply.

The trailer socket of your vehicle is equipped at the factory with a permanent power supply.

The permanent power supply is supplied via trailer socket pin 9.

A qualified specialist workshop can provide more information about installing the trailer electrics.

## Trailer with 7-pin connector

### General notes

**Trailers with 7-pin connector:** you can make a connection to the 13-pin connector on the ball coupling using an adapter plug or, if necessary, an adapter cable. Both can be obtained in a qualified specialist workshop.

### Installing the adapter

- ! Make sure that there is enough slack in the cable for cornering so that the cable cannot become detached.

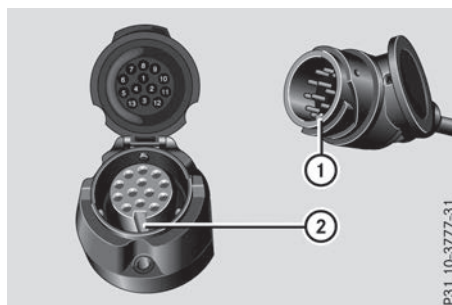

- ▶ Open the socket cover.
- ▶ Insert the connector with lug ① into groove ② on the socket and turn it clockwise to the stop.
- ▶ Make the cover engage.
- ▶ If you are using an adapter cable, secure the cable to the trailer with cable ties.

When the socket is connected, PARKTRONIC is deactivated.

### Important safety notes

#### WARNING

If you operate information systems and communication equipment integrated in the vehicle when driving, you may be distracted from the traffic situation. You could also lose control of the vehicle. There is a risk of an accident.

Only operate this equipment when the traffic situation permits. If you are not sure that this is possible, park the vehicle paying attention to traffic conditions and operate the equipment when the vehicle is stationary.

You must observe the legal requirements for the country in which you are currently driving when operating the on-board computer.

#### WARNING

If the instrument cluster has failed or malfunctioned, you may not recognize function restrictions in systems relevant to safety. The operating safety of your vehicle may be impaired. There is a risk of an accident.

Drive on carefully. Have the vehicle checked at a qualified specialist workshop immediately.

If the operating safety of your vehicle is impaired, pull over as soon as it is safe to do so. Contact a qualified specialist workshop.

The on-board computer only shows messages or warnings from certain systems in the multifunction display. You should therefore make sure your vehicle is operating safely at all times.



For an overview, see the instrument panel illustration (> page 32).

### Displays and operation

#### Instrument cluster lighting

The brightness control knob is located on the bottom left of the instrument cluster (> page 32).

- ▶ Turn the brightness control knob clockwise or counter-clockwise.

If the light switch is set to the **AUTO**,  or  position, the brightness is dependent upon the brightness of the ambient light.

- ❗ The light sensor in the instrument cluster automatically controls the brightness of the multifunction display.  
In daylight, the displays in the instrument cluster are not illuminated.

#### Speedometer with segments

The segments in the speedometer indicate which speed range is available.

- Cruise control activated (> page 133):  
The segments light up from the stored speed to the end of the scale.
- DISTRONIC PLUS activated (> page 136):  
One or two segments in the set speed range light up.
- DISTRONIC PLUS detects a vehicle in front:  
The segments between the speed of the vehicle in front and the stored speed light up.

#### Tachometer

- ❗ Do not drive in the overrevving range, as this could damage the engine.

The red band in the tachometer indicates the engine's overrevving range.

The fuel supply is interrupted to protect the engine when the red band is reached.

#### Outside temperature display

You should pay special attention to road conditions when temperatures are around freezing point.

Bear in mind that the outside temperature display indicates the temperature measured and does not record the road temperature.

The outside temperature display is in the multifunction display (> page 162).

Changes in the outside temperature are displayed after a short delay.

**Coolant temperature gauge**

**⚠ WARNING**

Opening the hood when the engine is overheated or when there is a fire in the engine compartment could expose you to hot gases or other service products. There is a risk of injury.

Let an overheated engine cool down before opening the hood. If there is a fire in the engine compartment, keep the hood closed and contact the fire department.

**!** If the coolant temperature is too high, a display message is shown.

If the coolant temperature display is in the area marked in red, do not continue driving. Otherwise, the engine will be damaged.

The coolant temperature gauge is in the instrument cluster on the right-hand side (> page 32). Under normal operating conditions and at the correct coolant level, the gauge may rise to the **H** marking.

**Operating the on-board computer**

**Overview**



- ① Multifunction display
- ② Switches on the Voice Control System (see the separate operating instructions)
- ③ Right control panel

- ④ Left control panel
- ⑤ Back button

► **To activate the on-board computer:** turn the SmartKey to position **1** in the ignition lock (> page 105).

You can control the multifunction display and the settings in the on-board computer using the buttons on the multifunction steering wheel.



**Left control panel**

- Calls up the menu and menu bar
- 
- Press briefly:**
  - Scrolls in lists
  - Selects a submenu or function
  - In the **Audio** menu: selects the previous or next station, when the preset list or station list is active, or an audio track or video scene
  - In the **Te1** (telephone) menu: switches to the phone book and selects a name or telephone number



- Press and hold:**
  - In the **Audio** menu: selects a preset list or a station list in the desired frequency range or an audio track or video scene using rapid scrolling
  - In the **Te1** (Telephone) menu: starts rapid scrolling if the phone book is open
- OK**
  - Confirms a selection/display message
  - In the **Te1** (Telephone) menu: switches to the phone book and starts dialing the selected number

**Right control panel**

- Rejects or ends a call
- Exits phone book/redial memory
- Makes or accepts a call
- Switches to the redial memory
- Adjusts the volume
-

	• Mute
	• Switches on the Voice Control System (see the separate operating instructions)



### Back button

	<b>Press briefly:</b> <ul style="list-style-type: none"> <li>• Back</li> <li>• Switches off the Voice Control System</li> <li>• Hides display messages/calls up the last <b>Trip</b> menu function used</li> <li>• Exits the telephone book/redial memory</li> </ul>
	<b>Press and hold:</b> <ul style="list-style-type: none"> <li>• Calls up the standard display in the <b>Trip</b> menu</li> </ul>

### Multifunction display



- ① Transmission position (▷ page 112)
- ② Drive program (▷ page 115)
- ③ Text field
- ④ Menu bar
- ⑤ Time
- ⑥ Outside temperature or speed (▷ page 168)
- ⑦ Transfer case position (▷ page 149)

- **To display menu bar ④:** press the  or  button on the steering wheel. If you do not press the buttons any longer, menu bar ④ is faded out after a few seconds. Text field ③ shows the selected menu or submenu and display messages.

Set the time using the multimedia system; see the Digital Operator's Manual.

The following messages may appear in the multifunction display:

- ↑ Shift recommendation (▷ page 117)
- CRUISE** Cruise control (▷ page 133)
-  ECO start/stop function (▷ page 107)
- LOW RANGE** Transfer case position (▷ page 149)
- HOLD** HOLD function (▷ page 142)

## Menus and submenus

### Menu overview

Using the  or  button on the steering wheel, open the menu bar.

Operating the on-board computer (▷ page 161). Depending on the equipment installed in the vehicle, you can call up the following menus:

- **Trip** menu (▷ page 163)
- **Navi** menu (navigation instructions) (▷ page 164)
- **Audio** menu (▷ page 165)
- **Tel** menu (telephone) (▷ page 166)
- **DriveAssist** menu (assistance) (▷ page 167)
- **Serv.** menu (▷ page 167)
- **Sett.** menu (settings) (▷ page 168)
- **AMG** menu in Mercedes-AMG vehicles (▷ page 171)

### Trip menu

#### Standard display



P54.33-4490-31

- ▶ Press and hold the button on the steering wheel until the **Trip** menu with trip odometer ① and odometer ② appears.

#### Trip computer "From start" or "From reset"

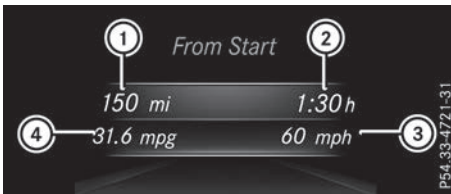

P54.33-4721-31

- ① Distance
  - ② Driving time
  - ③ Average speed
  - ④ Average fuel consumption
- ▶ Press the or button on the steering wheel to select the **Trip** menu.
  - ▶ Press the or button to select **From Start** or **From Reset**.

The values in the **From Start** submenu are calculated from the start of a journey whilst the values in the **From Reset** submenu are calculated from the last time the submenu was reset (▷ page 163).

In the following cases, the **From Start** trip computer is automatically reset:

- the ignition has been switched off for more than four hours.
- 999 hours have been exceeded.
- 9,999 miles have been exceeded.

The **From Reset** trip computer is automatically reset if the value exceeds 9,999 hours or 99,999 miles.

### Range

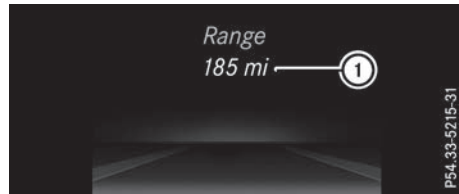

P54.33-5215-31

- ① Approximate range
- ▶ Press the or button on the steering wheel to select the **Trip** menu.
  - ▶ Press the or button to select the approximate range.

The approximate range that can be covered depends on the fuel level and your current driving style. If there is only a small amount of fuel left in the fuel tank, a vehicle being refueled appears instead of approximate range.

### Digital speedometer

- ▶ Press the or button on the steering wheel to select the **Trip** menu.
  - ▶ Press the or button to select the digital speedometer.
- A gearshift recommendation can also be displayed in the multifunction display. Observe the information on gearshift recommendation when shifting manually (▷ page 117).

### Resetting values

- ▶ Press the or button on the steering wheel to select the **Trip** menu.
- ▶ Press the or button to select the function that you wish to reset.
- ▶ Press **OK**.
- ▶ Press the button to select **Yes** and press **OK** to confirm.

You can reset the values of the following functions:

- Trip odometer
- "From Start" trip computer
- "From Reset" trip computer

## Navigation system menu

### Displaying navigation instructions

In the **Navi** menu, the multifunction display shows navigation instructions.

Further information about navigation (see the Digital Operator's Manual).

- ▶ Switch on the multimedia system (see the Digital Operator's Manual)
- ▶ Press the ◀ or ▶ button on the steering wheel to select the **Navi** menu.

### Route guidance not active



- ① Direction of travel
- ② Current road

### Route guidance active

#### No change of direction announced



- ① Distance to destination
- ② Distance to the next change of direction
- ③ Current road
- ④ "Follow the road's course" symbol

### Change of direction announced without a lane recommendation

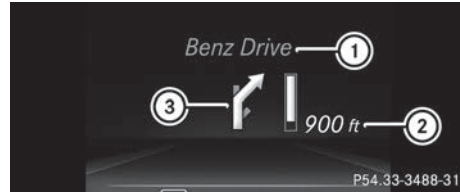

- ① Road into which the change of direction leads
- ② Distance to change of direction and visual distance display
- ③ Change-of-direction symbol

When a change of direction is announced, you will see change-of-direction symbol ③ and distance graphic ②. The distance indicator shortens towards the top of the display as you approach the point of the announced change of direction.

### Change of direction announced with a lane recommendation



- ① Road into which the change of direction leads
- ② Distance to change of direction and visual distance display
- ③ Lanes not recommended
- ④ Recommended lane and new lane during a change of direction
- ⑤ Change-of-direction symbol

On multilane roads, new lane recommendations can be displayed for the next change of direction if the digital map supports this data. During the change of direction, new lanes may be added.

Lane not recommended ③: you will not be able to complete the next change of direction if you stay in this lane.

Recommended lane and new lane during a change of direction ④: in this lane you will be able to complete the next two changes of direction without changing lane.

### Other status indicators of the navigation system



The navigation system displays additional information and the vehicle status.

Possible displays:

- **New Route...** or **Calculating Route...**  
A new route is calculated.
- **Road Not Mapped**  
The vehicle position is inside the area of the digital map, but the road is not recognized, e.g. new roads, parkings lots or private land.
- **No Route**  
No route could be calculated to the selected destination.
-   
You have reached the destination or an intermediate destination.





### Audio menu

#### Selecting a radio station



- ① Active station list
- ② Station frequency with memory position

The multifunction display shows station ② with station frequency or station name. The preset position is only displayed along with station ② if this has been stored.

- ▶ Switch on the multimedia system and select Radio.
- ▶ Press the  or  button on the steering wheel to select the **Audio** menu.
- ▶ **To select a preset list or station list:** press and briefly hold the  or  button until

the preset list or station list is shown in the desired frequency range.

- ▶ **To select a station:** briefly press  or .







SIRIUS XM satellite radio functions like a normal radio.



Further information on radio mode (see the Digital Operator's Manual).

#### Operating audio devices or media



Audio data from various audio devices or media can be played, depending on the equipment installed in the vehicle.

- ▶ Switch on the multimedia system and select audio CD or MP3 mode.
- ▶ Press the  or  button on the steering wheel to select the **Audio** menu.
- ▶ **To select the next/previous track:** briefly press the  or  button.
- ▶ **To select a track from the track list (rapid scrolling):** press and hold the  or  button until desired track ① appears.

If you press and hold the  or  button, the rapid scrolling speed is increased. Not all audio drives or data carriers support this function.

If track information is stored on the audio device or medium, the multifunction display will show the number and title of the track.

### Video DVD operation

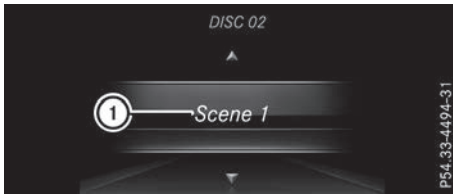

- ▶ Switch on the multimedia system and select video DVD.
- ▶ Press the ◀ or ▶ button on the steering wheel to select the **Audio** menu.
- ▶ **To select the next or previous scene:** briefly press the ▲ or ▼ button.
- ▶ **To select a scene from the scene list (rapid scrolling):** press and hold the ▲ or ▼ button until desired scene ① has been reached.

### TV operation



The preset position is only displayed along with channel ① if this has been stored. You can store TV channels in the multimedia system.

- ▶ Switch on the multimedia system and select TV.
- ▶ Press the ◀ or ▶ button on the steering wheel to select the **Audio** menu.
- ▶ **To select a stored channel:** briefly press the ▲ or ▼ button.
- ▶ **To select a channel from the channel list:** press and briefly hold the ▲ or ▼ button.

### Telephone menu

#### Introduction

#### **WARNING**

If you operate information systems and communication equipment integrated in the vehi-

cle when driving, you may be distracted from the traffic situation. You could also lose control of the vehicle. There is a risk of an accident.

Only operate this equipment when the traffic situation permits. If you are not sure that this is possible, park the vehicle paying attention to traffic conditions and operate the equipment when the vehicle is stationary.

When telephoning, you must observe the legal requirements for the country in which you are currently driving.

- ▶ Switch on the mobile phone (see the manufacturer's operating instructions).
- ▶ Switch on the multimedia system (see the Digital Operator's Manual)
- ▶ Establish a Bluetooth® connection to the multimedia system (see the Digital Operator's Manual).
- ▶ Press the ◀ or ▶ button on the steering wheel to select the **Te1** menu.

You will see one of the following display messages in the multifunction display:

- **Phone READY** or the name of the network provider: the mobile phone has found a network and is ready to receive.
- **Phone No Service:** there is no network available or the mobile phone is searching for a network.

### Accepting a call

If someone calls you when you are in the **Te1** menu, a display message appears in the multifunction display.

You can accept a call at any time regardless of the menu selected.

- ▶ Press the  button on the steering wheel to accept an incoming call.

### Rejecting or ending a call

- ▶ Press the  button on the steering wheel.

You can end or reject a call even if you are not in the **Te1** menu.



## Dialing a number from the phone book

- ▶ Press the or button on the steering wheel to select the **Te1** menu.
- ▶ Press , or **OK** to switch to the phone book.
- ▶ Authorize access to the phone book on the phone.
- ▶ Press the or button to select the desired name.

or

- ▶ **To start rapid scrolling:** press and hold or for longer than one second. Rapid scrolling stops when you release the button or reach the end of the list.

- ▶ **If only one telephone number is stored for a name:** press the or **OK** button to start dialing.

or

- ▶ **If there is more than one number for a particular name:** press the or **OK** button to display the numbers.
- ▶ Press the or button to select the number you want to dial.
- ▶ Press the or **OK** button to start dialing.

or

- ▶ **To exit the phone book:** press the or button.

## Redialing

The on-board computer saves the last names or numbers dialed in the redial memory.

- ▶ Press the or button on the steering wheel to select the **Te1** menu.
- ▶ Press the button to switch to the redial memory.
- ▶ Press the or button to select the desired name or number.
- ▶ Press the or **OK** button to start dialing.

or

- ▶ **To exit the redial memory:** press the or button.

## Assistance menu

### Introduction

In the **DriveAssist** menu, you have the following options:

- Displaying the assistance graphic (▷ page 167)
- Activating/deactivating Blind Spot Assist (▷ page 167)

### Displaying the assistance graphic

- ▶ Press the or button on the steering wheel to select the **DriveAssist** menu.
- ▶ Press or to select **Assistance Graphic**.
- ▶ Press **OK**.  
The DISTRONIC PLUS distance display appears in the multifunction display.

### Activating/deactivating Blind Spot Assist

- ▶ Press the or button on the steering wheel to select the **DriveAssist** menu.
- ▶ Press the or button to select **Blind Spot Assist**.
- ▶ Press **OK**.  
The current selection appears.
- ▶ **To activate/deactivate:** press the **OK** button again.

For further information about Blind Spot Assist, see (▷ page 140).

## Service menu

In the **Serv.** menu, you have the following options:

- Calling up display messages (▷ page 174)
- Checking the tire pressure electronically (▷ page 264)
- Calling up the service due date (▷ page 236)
- Checking the engine oil level (▷ page 232)

## Settings menu

### Introduction

In the **Sett.** menu, you have the following options:







- ▶ Changing the instrument cluster settings (▷ page 168)
- ▶ Changing the light settings (▷ page 169)
- ▶ Changing the vehicle settings (▷ page 170)
- ▶ Changing the convenience settings (▷ page 170)
- ▶ Restoring the factory settings (▷ page 171)

### Instrument cluster

#### Selecting the distance unit

The **Display Unit Speed-/Odometer:** function allows you to choose whether certain displays appear in kilometers or miles in the multifunction display.

You can determine whether the multifunction display shows certain messages in miles or kilometers.







- ▶ Press the  or  button on the steering wheel to select the **Sett.** menu.
- ▶ Press the  or  button to select the **Instrument Cluster** submenu.
- ▶ Press **OK** to confirm.
- ▶ Press the  or  button to select the **Display Unit Speed-/Odometer** function. You will see the selected setting: **km** or **miles**.
- ▶ Press the **OK** button to save the setting.

The selected unit of measurement for distance applies to:

- digital speedometer in the **Trip** menu
- the odometer and the trip odometer
- the trip computer
- the current consumption and the range
- the navigation instructions in the **Navi** menu
- cruise control
- DISTRONIC PLUS
- the service interval display









#### Selecting permanent display

You can determine whether the multifunction display permanently shows your speed or the outside temperature.

- ▶ Press the  or  button on the steering wheel to select the **Sett.** menu.
- ▶ Press the  or  button to select the **Instrument Cluster** submenu.
- ▶ Press **OK** to confirm.
- ▶ Press the  or  button to select the **Permanent Display:** function. You will see the selected setting: **Outside Temperature** or **Speedometer [mph]**.
- ▶ Press the **OK** button to save the setting.











**i** The speed is displayed in mph.

#### Selecting the language

- ▶ Press the  or  button on the steering wheel to select the **Settings** menu.
- ▶ Press the  or  button to select the **Instr. Cluster** submenu.
- ▶ Press **OK** to confirm.
- ▶ Press  or  to select the **Language:** function. You will see the current setting.
- ▶ Press **OK** to confirm.
- ▶ Press the  or  button to change the setting.
- ▶ Press the **OK** button to store the entry.

### Time/date

#### Setting the date

- ▶ Press the  or  button on the steering wheel to select the **Settings** menu.
- ▶ Press  or  to select the **Time/Date** submenu.
- ▶ Press **OK** to confirm.
- ▶ Press  or  to select the **Date:** function. You will see the current setting.
- ▶ **To set the date:** press **OK** again.
- ▶ Press  or  to switch between the day, month and year.
- ▶ Press  or  to set the day, month or year.
- ▶ Press **OK** to store the entry. The display shows the selected date.

### Setting the time

- ▶ Press the ◀ or ▶ button on the steering wheel to select the **Settings** menu.
- ▶ Press ▼ or ▲ to select the **Time/Date** submenu.
- ▶ Press **OK** to confirm.
- ▶ Press ▼ or ▲ to select the **Time:** function.
 

You will see the current setting.
- ▶ **To set the time:** press **OK** again.
- ▶ Press ◀ or ▶ to switch between hours and minutes.
- ▶ Press ▼ or ▲ to set the hours or minutes.
- ▶ Press **OK** to store the entry.
 

The display shows the selected time.

### Lights

#### Setting the daytime running lamps

- i** This function is not available in Canada.
- ▶ Press the ◀ or ▶ button on the steering wheel to select the **Sett.** menu.
- ▶ Press the ▼ or ▲ button to select the **Lights** submenu.
- ▶ Press **OK** to confirm.
- ▶ Press the ▼ or ▲ button to select the **Daytime Running Lights** function.
 

If the **Daytime Running Lights** function has been switched on, the cone of light and the ☼ symbol are shown in red in the multifunction display.
- ▶ Press the **OK** button to save the setting.

Further information on daytime running lamps (▷ page 86).

#### Surround lighting and exterior lighting delayed switch-off

- ▶ Press the ◀ or ▶ button on the steering wheel to select the **Sett.** menu.
- ▶ Press the ▼ or ▲ button to select the **Light** submenu.
- ▶ Press **OK** to confirm.
- ▶ Press the ▼ or ▲ button to select the **Surround Lighting** function.
 

When the **Surround Lighting** function has been activated, the cone of light is shown in red in the multifunction display.
- ▶ Press the **OK** button to save the setting.

To deactivate exterior lighting delayed switch-off temporarily:

- ▶ Before leaving the vehicle, turn the SmartKey to position **0** in the ignition lock (▷ page 105).
- ▶ Turn the SmartKey to position **2** in the ignition lock (▷ page 105).
 

Exterior lighting delayed switch-off is deactivated.

Exterior lighting delayed switch-off is reactivated the next time you start the engine.

If you have activated the **Surround Lighting** function and the light switch is set to **AUTO**, the following functions are switched on when it is dark:

- **surround lighting:** the exterior lighting remains lit for 40 seconds after unlocking with the SmartKey. If you start the engine, the surround lighting is switched off and automatic headlamp mode is activated (▷ page 87).
- **exterior lighting delayed switch-off:** the exterior lighting remains lit for 60 seconds after the engine is switched off. If you close all the doors and the trunk lid, the exterior lighting goes off after five seconds.



**i** Depending on your vehicle's equipment, when the surround lighting and exterior lighting delayed switch-off are on, the following light up:

- Parking lamps
- Low-beam headlamps
- Daytime running lamps
- Side marker lamps
- Surround lighting in the exterior mirrors

#### Switching the interior lighting delayed switch-off on/off

If you activate the **Interior Lighting Delay** function, the interior lighting remains on for 20 seconds after you remove the SmartKey from the ignition lock.







- ▶ Press the ◀ or ▶ button on the steering wheel to select the **Sett.** menu.
- ▶ Press the ▼ or ▲ button to select the **Lights** submenu.
- ▶ Press **OK** to confirm.

- ▶ Press the  or  button to select the **Interior Lighting Delay** function. If the **Interior Lighting Delay** function has been activated, the vehicle interior is displayed in red in the multifunction display.
- ▶ Press the  button to save the setting.

## Vehicle

### Activating/deactivating the automatic door locking mechanism

If you activate the **Automatic Door Lock** function, the vehicle is centrally locked above a speed of approximately 9 mph (15 km/h).









- ▶ Press the  or  button on the steering wheel to select the **Sett.** menu.
- ▶ Press the  or  button to select the **Vehicle** submenu.
- ▶ Press  to confirm.
- ▶ Press the  or  button to select the **Automatic Door Lock** function. When the **Automatic Door Lock** function is activated, the vehicle doors are displayed in red in the multifunction display.

- ▶ Press the  button to save the setting.

For further information on the automatic locking feature, see (▷ page 67).

### Activating/deactivating the acoustic locking verification signal

If you switch on the **Acoustic Lock** function, an acoustic signal sounds when you lock the vehicle.

- ▶ Press the  or  button on the steering wheel to select the **Sett.** menu.
- ▶ Press the  or  button to select the **Vehicle** submenu.
- ▶ Press  to confirm.
- ▶ Press the  or  button to select the **Acoustic Lock** function. If the **Acoustic Lock** function is activated, the  symbol in the multifunction display lights up red.
- ▶ Press the  button to save the setting.

## Comfort

### Activating/deactivating the EASY-ENTRY/EXIT feature

#### WARNING









When the EASY-ENTRY/EXIT feature adjusts the steering wheel, you and other vehicle occupants – particularly children – could become trapped. There is a risk of injury.

While the EASY-ENTRY/EXIT feature is making adjustments, make sure that no one has any body parts in the sweep of the steering wheel.

If somebody becomes trapped:

- press one of the memory function position buttons, or
- move the switch for steering wheel adjustment in the opposite direction to that in which the steering wheel is moving.





The adjustment process is stopped.

- ▶ Press the  or  button on the steering wheel to select the **Sett.** menu.
- ▶ Press the  or  button to select the **Convenience** submenu.
- ▶ Press  to confirm.
- ▶ Press the  or  button to select the **Easy Entry/Exit** function. If the **Easy Entry/Exit** function is activated, the vehicle steering wheel appears in red in the multifunction display.
- ▶ Press the  button to save the setting.

Further information on the EASY-ENTRY/EXIT feature (▷ page 81).

### Switching the fold-in mirrors when locking feature on/off

When you activate the **Auto. Mirror Folding** function, the exterior mirrors are folded in when the vehicle is locked. If you unlock the vehicle and then open a door, the exterior mirrors fold out again.

- ▶ Press the  or  button on the steering wheel to select the **Sett.** menu.
- ▶ Press the  or  button to select the **Convenience** submenu.
- ▶ Press  to confirm.

- ▶ Press the or button to select the **Auto. Mirror Folding** function. If the **Auto. Mirror Folding** function is activated, the vehicle's exterior mirror is displayed in red in the multifunction display.
- ▶ Press the button to save the setting.



- ① To fold the exterior mirrors in or out
- If you have activated the **Auto. Mirror Folding** function and you fold the exterior mirrors in using button ①, they will not fold out automatically (> page 82).
- You can then only fold out the exterior mirrors using button ①.

### Restoring the factory settings

- ▶ Press the or button on the steering wheel to select the **Sett.** menu.
- ▶ Press the or button to select the **Factory Setting** submenu.
- ▶ Press to confirm. The **Reset All Settings?** display message appears.
- ▶ Press the or button to select **No** or **Yes**.
- ▶ Press to confirm the selection. If you have selected **Yes** and confirmed, the multifunction display shows a confirmation message.

For safety reasons, the **Daytime Running Lights** function in the **Light** submenu is only reset if the vehicle is stationary.

### AMG menu in Mercedes-AMG vehicles

#### AMG displays



- ① Digital speedometer
- ② Gear indicator
- ③ Upshift indicator
- ④ Engine oil temperature
- ⑤ Coolant temperature
- ⑥ Transmission oil temperature

- ▶ Press or on the steering wheel to select the **AMG** menu.

Upshift indicator **UP** ③ indicates that the engine has reached the overrevving range when in the manual gearshift program. Upshift indicator **UP** ③ fades out other messages until you have shifted up.

If the engine oil temperature is below 176 °F (80 °C), the oil temperature is shown in blue. Avoid driving at full engine output during this time.

#### SETUP



- ① Drive program (**C/S/M**)
- ② ESP® mode (**ON/OFF**)

SETUP shows the drive program and the ESP® (Electronic Stability Program) mode.

- ▶ Press the or button on the steering wheel to select the **AMG** menu.
- ▶ Press repeatedly until SETUP appears.

## RACE TIMER

### Displaying and starting RACE TIMER

The RACE TIMER is only intended for use on a closed race circuit. Do not use the function on public roads.



- ① Lap
- ② RACE TIMER

You can start the RACE TIMER when the engine is running or if the SmartKey is in position **2** (▷ page 105) in the ignition lock.

- ▶ Press **◀** or **▶** on the steering wheel to select the **AMG** menu.
- ▶ Press the **▲** button repeatedly until the RACE TIMER appears.
- ▶ **To start:** press the **OK** button to start the RACE TIMER.

### Displaying the intermediate time



- ▶ Press the **◀** or **▶** button to select **Interm. Time**.
- ▶ Press **OK** to confirm. The intermediate time is shown for five seconds.

### Starting a new lap



- ① RACE TIMER
- ② Fastest lap time (best lap)
- ③ Lap

- ▶ Press **OK** to confirm **New Lap**.

**i** It is possible to store a maximum of sixteen laps. The 16th lap can only be completed with **Finish Lap**.

### Stopping the RACE TIMER



- ▶ Press the **↵** button on the steering wheel.
- ▶ Confirm **Yes** with **OK**.

The RACE TIMER interrupts timing if you stop the vehicle and turn the SmartKey to position **1** (▷ page 105) in the ignition lock. If you turn the SmartKey to position **2** or **3** (▷ page 105) and then press **OK** to confirm **Start**, timing is continued.

### Resetting the current lap

- ▶ Stop the RACE TIMER (▷ page 172).
- ▶ Press the **◀** or **▶** button to select **Reset Lap**.
- ▶ Press **OK** to reset the lap time to "0".

### Deleting all laps

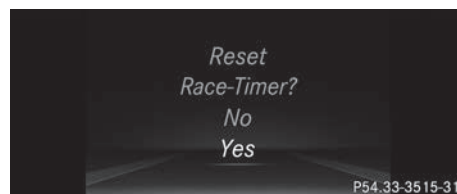

If you switch off the engine, the RACE TIMER is reset to "0" after 30 seconds. All laps are deleted.

You cannot delete individual stored laps. If you have stopped 16 laps, the current lap does not have to be reset.

- ▶ Reset the current lap (▷ page 172).
- ▶ Press **[OK]** to confirm **Reset**.  
The **Reset Race-Timer?** display message appears in the multifunction display.
- ▶ Press the **[▼]** button to select **Yes** and press the **[OK]** button to confirm.  
All laps are deleted.

### Overall statistics

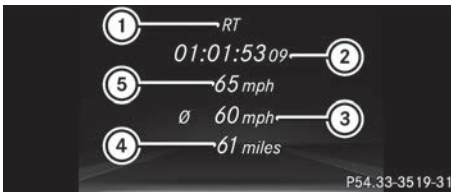

- ① RACETIMER overall evaluation
- ② Total time driven
- ③ Average speed
- ④ Distance covered
- ⑤ Maximum speed

If you save at least one lap and then stop RACE-TIMER, an overall evaluation is available.

- ▶ Press the **[◀]** or **[▶]** button on the steering wheel to select the **AMG** menu.
- ▶ Press the **[▲]** button repeatedly until the overall evaluation appears.

### Lap statistics

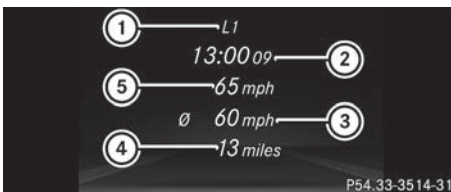

- ① Lap
- ② Lap time
- ③ Average lap speed
- ④ Lap length
- ⑤ Top speed during lap

This function is only available if you have stored at least two laps and have stopped the RACE-TIMER.

- ▶ Press the **[◀]** or **[▶]** button on the steering wheel to select the **AMG** menu.
- ▶ Press **[▲]** repeatedly until a lap evaluation appears.  
Each lap appears in a separate submenu. The fastest lap is indicated by flashing symbol ①.
- ▶ Press the **[▲]** or **[▼]** button to select a different lap evaluation.

## Display messages

### Introduction

#### General notes

Display messages appear in the multifunction display.

Display messages with graphic displays may be shown in simplified form in the Operator's Manual and may therefore differ from the multifunction display.

Please respond in accordance with the display messages and follow the additional notes in this Operator's Manual.

Certain display messages are accompanied by an audible warning tone or a continuous warning tone.

When you stop and park the vehicle, please observe the notes on:

- HOLD function (▷ page 142)
- Parking (▷ page 122)

#### Hiding display messages





- ▶ Press the **[OK]** or **[☰]** button on the steering wheel.  
The multifunction display hides the display message.



High-priority display messages are shown in red in the multifunction display. Some high-priority display messages cannot be hidden.

The multifunction display shows these messages continuously until the causes for the messages have been remedied.

### Message memory menu

The on-board computer saves certain display messages in the **message memory**. You can call up the display messages:

- ▶ Press the  or  button on the steering wheel to select the **Serv.** menu.  
If there are display messages, the multifunction display shows **2 Messages**, for example.
- ▶ Press the  or  button to select the entry, e.g. **2 Messages**.

- ▶ Press  to confirm.
- ▶ Press the  or  button to scroll through the display messages.

When the ignition is switched off, all display messages are deleted, apart from some high-priority display messages. Once the causes of the high-priority display messages have been rectified, the corresponding display messages are also deleted.



Safety systems

Display messages



ABS, ESP Defective  
Visit Workshop

Possible causes/consequences and ► Solutions

ABS (Anti-lock Braking System) and ESP® (Electronic Stability Program) are temporarily not available.  
Other driving systems and driving safety systems may also malfunction.

In addition, the and warning lamps light up in the instrument cluster.

Possible causes are:

- self-diagnosis is not yet complete
- the on-board voltage may be insufficient

**WARNING**

The brake system continues to function normally, but without the functions listed above. The wheels could therefore lock if you brake hard, for example.

The steerability and braking characteristics may be severely affected. The braking distance in an emergency braking situation can increase.

If ESP® is not operational, ESP® is unable to stabilize the vehicle.

There is an increased risk of skidding and an accident.

- Carefully drive a suitable distance, making slight steering movements at a speed above 12 mph (20 km/h).  
If the display message disappears, the functions mentioned above are available again.

If the display message remains on show:

- Drive on carefully.
- Visit a qualified specialist workshop.



Currently Unavailable  
See Operator's Manual

ABS and ESP® are malfunctioning.

Other driving systems and driving safety systems may also malfunction.

In addition, the and warning lamps light up in the instrument cluster.

**WARNING**











The brake system continues to function normally, but without the functions listed above. The wheels could therefore lock if you brake hard, for example.













The steerability and braking characteristics may be severely affected. The braking distance in an emergency braking situation can increase.









If ESP® is not operational, ESP® is unable to stabilize the vehicle.



There is an increased risk of skidding and an accident.





- Drive on carefully.
- Visit a qualified specialist workshop immediately.



Display messages	Possible causes/consequences and ► Solutions
 <p>ESP Defective Visit Workshop</p>	<p>ESP<sup>®</sup> is malfunctioning. Other driving systems and driving safety systems may also malfunction. The  warning lamp also lights up in the instrument cluster. The self-diagnosis function might not be complete, for example.</p> <p> <b>WARNING</b></p> <p>The brake system continues to function normally, but without the functions listed above. The braking distance in an emergency braking situation can thus increase. There is an increased risk of skidding and an accident.</p> <ul style="list-style-type: none"> <li>► Drive on carefully.</li> <li>► Visit a qualified specialist workshop.</li> </ul>
 <p>ABS, ESP, EBD Defective Visit Workshop</p>	<p>EBD (electronic brake force distribution), ABS and ESP<sup>®</sup> are malfunctioning. Other driving systems and driving safety systems may also malfunction. In addition, the ,  and  warning lamps light up in the instrument cluster and a warning tone sounds.</p> <p> <b>WARNING</b></p> <p>The brake system continues to function normally, but without the functions listed above. The front and rear wheels could therefore lock if you brake hard, for example. The steerability and braking characteristics may be severely affected. The braking distance in an emergency braking situation can increase. If ESP<sup>®</sup> is not operational, ESP<sup>®</sup> is unable to stabilize the vehicle. There is an increased risk of skidding and an accident.</p> <ul style="list-style-type: none"> <li>► Drive on carefully.</li> <li>► Visit a qualified specialist workshop immediately.</li> </ul>
 (USA only)  (Canada only) <p>Please Release Parking Brake</p>	<p>You are driving with the parking brake applied. A warning tone also sounds.</p> <ul style="list-style-type: none"> <li>► Release the parking brake.</li> </ul>



Display messages	Possible causes/consequences and ► Solutions
<p> (USA only) (Canada only) Check Brake Fluid Level</p>	<p>There is not enough brake fluid in the brake fluid reservoir. In addition, the  (USA only)/ (Canada only) warning lamp lights up in the instrument cluster and a warning tone sounds.</p> <p> <b>WARNING</b></p> <p>The braking effect may be impaired. There is a risk of an accident.</p> <ul style="list-style-type: none"> <li>► Pull over and stop the vehicle safely as soon as possible, paying attention to road and traffic conditions. Do not continue driving under any circumstances.</li> <li>► Secure the vehicle against rolling away (► page 122).</li> <li>► Consult a qualified specialist workshop.</li> <li>► Do not add brake fluid. This does not correct the malfunction.</li> </ul>
<p>  Check Brake Pad Wear</p>	<p>The brake pads/linings have reached their wear limit.</p> <ul style="list-style-type: none"> <li>► Visit a qualified specialist workshop.</li> </ul>
<p>  Inoperative</p>	<p><b>USA only:</b> one or more main functions of the mbrace system are malfunctioning.</p> <ul style="list-style-type: none"> <li>► Visit a qualified specialist workshop.</li> </ul>
<p>  SRS Malfunction Service Required</p>	<p>The restraint system is malfunctioning. The  warning lamp also lights up in the instrument cluster.</p> <p> <b>WARNING</b></p> <p>The air bags or Emergency Tensioning Devices may either be triggered unintentionally or, in the event of an accident, may not be triggered. There is an increased risk of injury.</p> <ul style="list-style-type: none"> <li>► Visit a qualified specialist workshop.</li> </ul> <p>For further information about the restraint system, see (► page 38).</p>
<p>  Front Left Malfunction Service Required or Front Right Malfunction Service Required</p>	<p>The restraint system has malfunctioned at the front on the left or right. The  warning lamp also lights up in the instrument cluster.</p> <p> <b>WARNING</b></p> <p>The air bags or Emergency Tensioning Devices may either be triggered unintentionally or, in the event of an accident, may not be triggered. There is an increased risk of injury.</p> <ul style="list-style-type: none"> <li>► Visit a qualified specialist workshop.</li> </ul>





Display messages	Possible causes/consequences and ► Solutions
 <p>Rear Left Malfunction Service Required or Rear Right Malfunction Service Required</p>	<p>The rear left-hand or right-hand restraint system has malfunctioned. The  warning lamp also lights up in the instrument cluster.</p> <p><b>⚠ WARNING</b></p> <p>The air bags or Emergency Tensioning Devices may either be triggered unintentionally or, in the event of an accident, may not be triggered. There is an increased risk of injury.</p> <p>► Visit a qualified specialist workshop.</p>
 <p>Rear Center Malfunction Service Required</p>	<p>The rear center restraint system has malfunctioned. The  warning lamp also lights up in the instrument cluster.</p> <p><b>⚠ WARNING</b></p> <p>The air bags or Emergency Tensioning Devices may either be triggered unintentionally or, in the event of an accident, may not be triggered. There is an increased risk of injury.</p> <p>► Visit a qualified specialist workshop.</p>
 <p>Left Side Curtain Airbag Malfunction Service Required or Right Side Curtain Airbag Malfunction Service Required</p>	<p>The left-hand or right-hand window curtain air bag is malfunctioning. The  warning lamp also lights up in the instrument cluster.</p> <p><b>⚠ WARNING</b></p> <p>The left or right window curtain air bag may either be triggered unintentionally or, in the event of an accident, may not be triggered. There is an increased risk of injury.</p> <p>► Visit a qualified specialist workshop.</p>
<p>Front Passenger Airbag Disabled See Operator's Manual</p>	<p>A BabySmart™ compatible child restraint system is installed on the front-passenger seat.</p> <p>The   indicator lamp also lights up. The front-passenger air bag is therefore disabled. Further information on BabySmart™ (► page 53).</p>

Display messages	Possible causes/consequences and ► Solutions
<p>Front Passenger Air-bag Enabled See Operator's Manual</p>	<p>The  indicator lamp does not remain lit if a special BabySmart™-compatible child restraint system has been installed on the front-passenger seat.</p> <p>The BabySmart™ system is malfunctioning.</p> <p><b>⚠ WARNING</b></p> <p>The front-passenger front air bag can be triggered unintentionally in the event of an accident.</p> <p>There is a risk of an accident.</p> <ul style="list-style-type: none"> <li>► Make sure there is nothing between the seat cushion and the child seat.</li> <li>► Check for correct installation of the child restraint system.</li> <li>► If the  indicator lamps do not light up, have the BabySmart™ system checked as soon as possible at a qualified specialist workshop.</li> </ul> <p>Do not transport a child on the front-passenger seat until the air bag deactivation system has been repaired.</p>
<p>Radar Sensors Dirty See Operator's Manual</p>	<p>The radar sensor system is malfunctioning.</p> <p>Possible causes are:</p> <ul style="list-style-type: none"> <li>• dirt on sensors</li> <li>• heavy rain or snow</li> <li>• when driving on inter-urban roads without traffic or infrastructure, e.g. in desert-like areas</li> </ul> <p>At least one driving system is malfunctioning or temporarily unavailable:</p> <ul style="list-style-type: none"> <li>• DISTRONIC PLUS</li> </ul> <p>A warning tone also sounds.</p> <p>Once the cause of the problem is no longer present, the driving systems will be available again. The display message disappears.</p> <p>If the display message does not disappear:</p> <ul style="list-style-type: none"> <li>► Pull over and stop the vehicle safely as soon as possible, paying attention to road and traffic conditions.</li> <li>► Secure the vehicle against rolling away (► page 122).</li> <li>► Switch off the engine.</li> <li>► Clean all sensors (► page 239).</li> <li>► Restart the engine.</li> </ul> <p>The display message disappears.</p>





Lights	
Display messages	Possible causes/consequences and ► Solutions
 Example: Check Left Low Beam	The bulb in question is malfunctioning. <ul style="list-style-type: none"> <li>► Visit a qualified specialist workshop.</li> </ul> or <ul style="list-style-type: none"> <li>► Check whether you are permitted to replace the bulb yourself (► page 89).</li> </ul> <p><b>i</b> LED light sources: the display message for the corresponding lamp only appears when all the LEDs in the lamp have failed.</p>
 Malfunction See Operator's Manual	The exterior lighting is malfunctioning. <ul style="list-style-type: none"> <li>► Visit a qualified specialist workshop.</li> </ul>
 Auto Lamp Function Inoperative	The light sensor is defective. <ul style="list-style-type: none"> <li>► Visit a qualified specialist workshop.</li> </ul>
 Switch Off Lights	The lights are still switched on when you leave the vehicle. A warning tone also sounds. <ul style="list-style-type: none"> <li>► Turn the light switch to position <b>AUTO</b>.</li> </ul>

Engine	
Display messages	Possible causes/consequences and ► Solutions
 Check Coolant Level See Operator's Manual	The coolant level is too low. <ul style="list-style-type: none"> <li>► Add coolant, observing the warning notes before doing so (► page 234).</li> <li>► Have the coolant system checked at a qualified specialist workshop if the coolant needs topping up more often than usual.</li> </ul>
	The fan motor is malfunctioning. <ul style="list-style-type: none"> <li>► If the coolant temperature is below the <b>H</b> mark, drive to the nearest qualified specialist workshop.</li> <li>► Avoid heavy loads on the engine as you do so, e.g. driving in mountainous terrain and stop-start traffic.</li> </ul>

Display messages	Possible causes/consequences and ► Solutions
 <p data-bbox="211 315 422 390">Coolant Too Hot Stop Vehicle Turn Engine Off</p>	<p data-bbox="471 265 743 324">The coolant is too hot. A warning tone also sounds.</p> <p data-bbox="480 336 632 365"> <b>WARNING</b></p> <p data-bbox="471 378 1126 453">Do not drive when your engine is overheated. This can cause some fluids which may have leaked into the engine compartment to catch fire.</p> <p data-bbox="471 462 1130 512">Steam from the overheated engine can also cause serious burns which can occur just by opening the hood.</p> <p data-bbox="471 521 698 542">There is a risk of injury.</p> <ul data-bbox="471 551 1131 915" style="list-style-type: none"> <li>▶ Pull over and stop the vehicle safely and switch off the engine, paying attention to road and traffic conditions.</li> <li>▶ Secure the vehicle against rolling away (▷ page 122).</li> <li>▶ Leave the vehicle and keep a safe distance from the vehicle until the engine has cooled down.</li> <li>▶ Make sure that the air supply to the engine radiator is not blocked, e.g. by snow, slush or ice.</li> <li>▶ Do not start the engine again until the display message goes out and the coolant temperature is below the <b>H</b> marking. Otherwise, the engine could be damaged.</li> <li>▶ Pay attention to the coolant temperature gauge.</li> <li>▶ If the temperature increases again, visit a qualified specialist workshop immediately.</li> </ul> <p data-bbox="471 924 1122 974">Under normal operating conditions and at the correct coolant level, the gauge may rise to the <b>H</b> marking.</p> <p data-bbox="471 996 764 1017">The poly-V-belt may have torn.</p> <ul data-bbox="471 1026 1131 1107" style="list-style-type: none"> <li>▶ Pull over and stop the vehicle safely and switch off the engine, paying attention to road and traffic conditions.</li> <li>▶ Check the poly-V-belt.</li> </ul> <p data-bbox="471 1116 725 1137"><b>If the poly-V-belt is torn:</b></p> <ul data-bbox="471 1161 1106 1223" style="list-style-type: none"> <li>▶  Do not continue driving. The engine could otherwise overheat.</li> <li>▶ Consult a qualified specialist workshop.</li> </ul> <p data-bbox="471 1232 817 1254"><b>If the poly-V-belt is not damaged:</b></p> <ul data-bbox="471 1268 1102 1381" style="list-style-type: none"> <li>▶ Wait until the display message disappears before restarting the engine. Otherwise, the engine could be damaged.</li> <li>▶ Pay attention to the coolant temperature gauge.</li> <li>▶ Visit a qualified specialist workshop.</li> </ul>





Display messages	Possible causes/consequences and ► Solutions
	<p>The battery is not being charged. A warning tone also sounds. Possible causes are:</p> <ul style="list-style-type: none"> <li>• a defective alternator</li> <li>• a torn poly-V-belt</li> <li>• a malfunction in the electronics</li> </ul> <p>► Pull over and stop the vehicle safely and switch off the engine, paying attention to road and traffic conditions. ► Open the hood. ► Check whether the poly-V-belt is torn.</p> <p><b>If the poly-V-belt is torn:</b></p> <p><b>!</b> Do not continue driving. The engine could otherwise overheat. ► Consult a qualified specialist workshop.</p> <p><b>If the poly-V-belt is not damaged:</b></p> <p>► Visit a qualified specialist workshop.</p>
 <p>Check Engine Oil At Next Refueling</p>	<p>The engine oil level has dropped to the minimum level. A warning tone also sounds.</p> <ul style="list-style-type: none"> <li>► Check the oil level when next refueling, at the latest (► page 232).</li> <li>► If necessary, add engine oil (► page 233).</li> <li>► Have the engine checked at a qualified specialist workshop if engine oil needs to be added more often than usual.</li> </ul> <p><b>!</b> Avoid long journeys with too little engine oil. The engine will otherwise be damaged.</p> <p>Information on approved engine oils can be obtained from any qualified specialist workshop or on the Internet at <a href="http://www.mbusa.com">http://www.mbusa.com</a> (USA only).</p>
 <p>Engine Oil Level Low Stop Vehicle Turn Engine Off</p>	<p>Mercedes-AMG vehicle: the engine oil level is too low. There is a risk of engine damage.</p> <ul style="list-style-type: none"> <li>► Pull over and stop the vehicle safely and switch off the engine, paying attention to road and traffic conditions.</li> <li>► Add engine oil (► page 233) and check the oil level (► page 232).</li> </ul>
 <p>Check Engine Oil Level (Add 1 quart)</p>	<p>Mercedes-AMG vehicles: the engine oil level is too low.</p> <ul style="list-style-type: none"> <li>► Check the oil level when next refueling, at the latest (► page 232).</li> <li>► If necessary, add engine oil (► page 233).</li> <li>► Have the engine checked at a qualified specialist workshop if engine oil needs to be added more often than usual.</li> </ul> <p><b>!</b> Avoid long journeys with too little engine oil. The engine will otherwise be damaged.</p> <p>Information on approved engine oils can be obtained from any qualified specialist workshop or on the Internet at <a href="http://www.mbusa.com">http://www.mbusa.com</a> (USA only).</p>



Display messages	Possible causes/consequences and ► Solutions
 Engine Oil Level Cannot Be Measured	Mercedes-AMG vehicles: the measuring system is malfunctioning. ► Visit a qualified specialist workshop.
 Fuel Level Low	The fuel level has dropped into the reserve range. ► Refuel at the nearest gas station.
 Gas Cap Loose	There is only a very small amount of fuel in the fuel tank. ► Refuel at the nearest gas station without fail.
 Gas Cap Loose	The fuel system pressure is too low. The fuel filler cap is not closed correctly or the fuel system is leaking. ► Check that the fuel filler cap is correctly closed. <b>If the fuel filler cap is not correctly closed:</b> ► Close the fuel filler cap. <b>If the fuel filler cap is correctly closed:</b> ► Visit a qualified specialist workshop.

Driving systems	
Display messages	Possible causes/consequences and ► Solutions
TC Shift Conditions Not Fulfilled Apply Brake/Parking Brake	The parking brake has not been applied and the brake pedal has not been depressed. The transfer case has canceled the gear change process and is in <b>Neutral</b> . There is no connection between the engine and the drive wheels. ► Pull over and stop the vehicle safely as soon as possible, paying attention to road and traffic conditions. ► Depress the brake pedal and apply the parking brake. ► Shift the automatic transmission into neutral position <b>N</b> . ► Make sure all conditions for changing gears are met (▷ page 149). ► Repeat the gearshift process.
TC Malfunction Visit Workshop Apply Parking Brake to Park	There is a malfunction in the transfer case. ► Do not shift the transfer case. ► When parking, secure the vehicle against rolling away (▷ page 122). ► Have the vehicle checked at a qualified specialist workshop.
TC Shift Canceled Please Reactivate	The transfer case has not performed the gearshift process. ► Repeat the gearshift process. ► Make sure all conditions for changing gears are met (▷ page 149).
TC Shift Conditions Not Fulfilled Max. Speed 25 mph	You have exceeded the maximum speed for the gearshift process. ► Drive more slowly. ► Repeat the gearshift process.

Display messages	Possible causes/consequences and ► Solutions
TC Shift Conditions Not Fulfilled Select NEUTRAL Gear	You have not met one or more shift conditions. ► Shift the automatic transmission into neutral position <b>N</b> . ► Repeat the gearshift process.
TC Shift Conditions Not Fulfilled Max. Speed 40 mph	You have exceeded the maximum speed for the gearshift process. ► Drive more slowly. ► Repeat the gearshift process.
LOW RANGE On	The transfer case is in the <b>LOW RANGE</b> off-road gear.
HIGH RANGE On	The transfer case is in the <b>HIGH RANGE</b> on-road position.
Differential Locks Available Only In LOW RANGE	The LOW RANGE button has been pressed. The transfer case is in <b>LOW RANGE</b> off-road gear and a differential lock is engaged. ► Disengage the differential lock (▷ page 151). ► Repeat the gearshift process.
TC NEUTRAL On	The transfer case is in the <b>Neutral</b> neutral position. A warning tone will also sound when the driver's door is opened and the brake pedal is not depressed. ► Close the driver's door. ► Secure the vehicle against rolling away (▷ page 122). ► Shift the transfer case according to driving conditions (▷ page 149).
Differential Lock Preselected ESP Not Available	A differential lock was engaged. The differential gear system has not yet locked the respective differential. The activation indicator lamp (yellow) (▷ page 151) of the switch lights up. ESP <sup>®</sup> is unavailable. ABS is still available.
Differential Locks Active ABS and ESP Not Available	A differential lock was engaged and the differential gear system has locked the respective differential. The yellow activation indicator lamp and red function indicator lamp (▷ page 151) on the switch lights up. ABS and ESP <sup>®</sup> are unavailable.





Display messages	Possible causes/consequences and ► Solutions
<p>Blind Spot Assist Currently Unavailable See Operator's Manual</p>	<p>Blind Spot Assist is temporarily inoperative. Possible causes are:</p> <ul style="list-style-type: none"> <li>• You have established the electrical connection between the trailer and your vehicle.</li> <li>• The sensors are dirty.</li> <li>• Function is impaired due to heavy rain or snow.</li> <li>• The radar sensor system is outside the operating temperature range.</li> <li>• The radar sensor system is temporarily inoperative, e.g. due to electromagnetic radiation emitted by nearby TV or radio stations or other sources of electromagnetic radiation.</li> </ul> <p>The yellow  indicator lamps also light up in the exterior mirrors.</p> <p>► When towing a trailer, confirm the display message with .</p> <p>If you are driving without a trailer and the display message does not disappear:</p> <ul style="list-style-type: none"> <li>► Pull over and stop the vehicle safely as soon as possible, paying attention to road and traffic conditions.</li> <li>► Apply the parking brake.</li> <li>► Clean the sensors (▷ page 239).</li> <li>► Restart the engine.</li> </ul> <p>If the system detects that the sensors are fully operational, the display message disappears.</p> <p>Blind Spot Assist is operational again.</p>
<p>Blind Spot Assist Not Available When Towing a Trailer See Operator's Manual</p>	<p>Blind Spot Assist is deactivated while towing a trailer. You have established the electrical connection between the trailer and your vehicle.</p> <p>► Press  on the steering wheel to confirm the display message.</p>
<p>Blind Spot Assist Inoperative</p>	<p>Blind Spot Assist is malfunctioning.</p> <p>The yellow  indicator lamps also light up in the exterior mirrors.</p> <p>► Visit a qualified specialist workshop.</p>
<p>DISTRONIC PLUS Off</p>	<p>DISTRONIC PLUS has been deactivated (▷ page 134). If it was deactivated automatically, a warning tone also sounds.</p>
<p>DISTRONIC PLUS Now Available</p>	<p>DISTRONIC PLUS is operational again after having been temporarily unavailable. You can now reactivate DISTRONIC PLUS (▷ page 134).</p>



Display messages	Possible causes/consequences and ► Solutions
<b>DISTRONIC PLUS</b> Currently Unavailable See Operator's Manual	<p>DISTRONIC is deactivated and temporarily inoperative. Possible causes are:</p> <ul style="list-style-type: none"> <li>• The DISTRONIC PLUS cover in the radiator trim is dirty</li> <li>• Function is impaired due to heavy rain or snow.</li> <li>• The sensors in the bumpers are dirty.</li> <li>• The radar sensor system is temporarily inoperative, e.g. due to electromagnetic radiation emitted by nearby TV or radio stations or other sources of electromagnetic radiation.</li> <li>• The system is outside the operating temperature range.</li> <li>• The transfer case is in the <b>LOW RANGE</b> transmission position.</li> <li>• The vehicle is on an uphill or a downhill slope of more than 22-25%</li> <li>• The on-board voltage is too low.</li> </ul> <p>A warning tone also sounds.</p> <p>If the display message does not disappear:</p> <ul style="list-style-type: none"> <li>► Pull over and stop the vehicle safely as soon as possible, paying attention to road and traffic conditions.</li> <li>► Apply the parking brake.</li> <li>► Clean the DISTRONIC PLUS cover in the radiator trim and the bumper (▷ page 239).</li> <li>► Restart the engine.</li> </ul> <p>If the system detects that the sensors are fully operational, the display message disappears.</p> <p>DISTRONIC PLUS is operational again.</p>
<b>DISTRONIC PLUS</b> Inoperative	<p>DISTRONIC PLUS is malfunctioning</p> <p>BAS (anti-lock braking system) may also have failed.</p> <p>A warning tone also sounds.</p> <ul style="list-style-type: none"> <li>► Visit a qualified specialist workshop.</li> </ul>
<b>DISTRONIC PLUS</b> Suspended	<p>You have depressed the accelerator pedal. DISTRONIC PLUS is no longer controlling the speed of the vehicle.</p> <ul style="list-style-type: none"> <li>► Remove your foot from the accelerator pedal.</li> </ul>
<b>DISTRONIC PLUS</b> - - - mph	<p>An activation condition for DISTRONIC PLUS is not fulfilled.</p> <ul style="list-style-type: none"> <li>► Check the activation conditions for DISTRONIC PLUS (▷ page 134).</li> </ul>
<b>Cruise Control</b> - - - mph	<p>A condition for activating cruise control has not been fulfilled.</p> <p>You have tried to store a speed below 20 mph (30 km/h), for example.</p> <ul style="list-style-type: none"> <li>► If conditions permit, drive faster than 20 mph (30 km/h) and store the speed.</li> <li>► Check the activation conditions for cruise control (▷ page 133).</li> </ul>

Tires	
Display messages	Possible causes/consequences and ► Solutions
Tire pressure will be displayed after driving a few minutes	<p>The tire pressure monitor is measuring the tire pressure.</p> <ul style="list-style-type: none"> <li>► Drive on. The tire pressures appear in the multifunction display after you have been driving for a few minutes.</li> </ul>
Tire Press. Monitor Inoperative	<p>The tire pressure monitor is faulty.</p> <ul style="list-style-type: none"> <li>► Visit a qualified specialist workshop.</li> </ul>
Tire Pressure Monitor Inoperative No Wheel Sensors	<p>The wheels mounted do not have a suitable tire pressure sensor. The tire pressure monitor is deactivated.</p> <ul style="list-style-type: none"> <li>► Mount wheels with suitable tire pressure sensors. The tire pressure monitor is activated automatically after driving for a few minutes.</li> </ul>
Check Tires	<p>The tire pressure in one or more tires has dropped significantly. The wheel position is shown in the multifunction display. A warning tone also sounds.</p> <p> <b>WARNING</b></p> <p>Tire pressures that are too low pose the following hazards:</p> <ul style="list-style-type: none"> <li>• they may burst, especially as the load and vehicle speed increase.</li> <li>• they may wear excessively and/or unevenly, which may greatly impair tire traction.</li> <li>• the driving characteristics, as well as steering and braking, may be greatly impaired</li> </ul> <p>There is a risk of an accident.</p> <ul style="list-style-type: none"> <li>► Stop the vehicle without making any sudden steering or braking maneuvers. Pay attention to the traffic conditions as you do so.</li> <li>► Secure the vehicle against rolling away (▷ page 122).</li> <li>► If there is a flat tire, inspect the tires (▷ page 246).</li> <li>► Check the tire pressure (▷ page 263).</li> <li>► If necessary, correct the tire pressure.</li> </ul>





Display messages	Possible causes/consequences and ► Solutions
Warning Tire Malfunction	<p>The tire pressure in one or more tires has dropped suddenly. The wheel position is shown in the multifunction display. A warning tone also sounds.</p> <p> <b>WARNING</b></p> <p>Driving with a flat tire poses a risk of the following hazards:</p> <ul style="list-style-type: none"> <li>• a flat tire affects the ability to steer or brake the vehicle</li> <li>• you could lose control of the vehicle</li> <li>• continued driving with a flat tire will cause excessive heat build-up and possibly a fire</li> </ul> <p>There is a risk of an accident.</p> <p>► Stop the vehicle without making any sudden steering or braking maneuvers. Pay attention to the traffic conditions as you do so.</p> <p>► Secure the vehicle against rolling away (▷ page 122).</p> <p>► If there is a flat tire, inspect the tires (▷ page 246).</p>
Please Correct Tire Pressure	<p>The tire pressure is too low in at least one of the tires, or the tire pressure difference between the wheels is too great.</p> <p>► Check the tire pressures at the next opportunity (▷ page 263).</p> <p>► If necessary, correct the tire pressure.</p> <p>► Restart the tire pressure monitor (▷ page 265).</p>
TirePress. Sensor(s) Missing	<p>There is no signal from the tire pressure sensor of one or several wheels. The pressure of the affected tire does not appear in the multifunction display.</p> <p>► Have the faulty tire pressure sensor replaced at a qualified specialist workshop.</p>
Tire Press. Monitor Currently Unavailable	<p>Because there is interference from a strong source of radio waves, no signals from the tire pressure sensors are detected. The tire pressure monitor is temporarily malfunctioning.</p> <p>► Drive on. The tire pressure monitor restarts automatically as soon as the problem has been resolved.</p>



Display messages	Possible causes/consequences and ► Solutions
 <p>Tire Pressure Warning, Tire Malfunction</p>	<p>The tire pressure in one or more tires has dropped suddenly. The wheel position is shown on the multifunction display. A warning tone also sounds.</p> <p> <b>WARNING</b></p> <p>Driving with a flat tire poses a risk of the following hazards:</p> <ul style="list-style-type: none"> <li>• a flat tire affects the ability to steer or brake the vehicle</li> <li>• you could lose control of the vehicle</li> <li>• continued driving with a flat tire will cause excessive heat build-up and possibly a fire</li> </ul> <p>There is a risk of an accident.</p> <ul style="list-style-type: none"> <li>► Stop the vehicle without making any sudden steering or braking maneuvers. Pay attention to the traffic conditions as you do so.</li> <li>► Secure the vehicle against rolling away (▷ page 122).</li> <li>► If there is a flat tire, inspect the tires (▷ page 246).</li> </ul>
 <p>Check Tire Pressure</p>	<p>The tire pressure in one or more tires has dropped significantly. The wheel position is shown on the multifunction display. A warning tone also sounds.</p> <p> <b>WARNING</b></p> <p>Tire pressures that are too low pose the following hazards:</p> <ul style="list-style-type: none"> <li>• they may burst, especially as the load and vehicle speed increase.</li> <li>• they may wear excessively and/or unevenly, which may greatly impair tire traction.</li> <li>• the driving characteristics, as well as steering and braking, may be greatly impaired</li> </ul> <p>There is a risk of an accident.</p> <ul style="list-style-type: none"> <li>► Stop the vehicle without making any sudden steering or braking maneuvers. Pay attention to the traffic conditions as you do so.</li> <li>► Secure the vehicle against rolling away (▷ page 122).</li> <li>► If there is a flat tire, inspect the tires (▷ page 246).</li> <li>► Check the tire pressure (▷ page 263).</li> <li>► If necessary, correct the tire pressure.</li> </ul>
 <p>Please Correct Tire Pressure</p>	<p>The tire pressure is too low in at least one of the tires, or the tire pressure difference between the wheels is too great.</p> <ul style="list-style-type: none"> <li>► Check the tire pressures at the next opportunity (▷ page 263).</li> <li>► If necessary, correct the tire pressure.</li> </ul>

Vehicle	
Display messages	Possible causes/consequences and ► Solutions
Shift to 'P' or 'N' to Start Engine	<p>You have attempted to start the engine with the transmission in position <b>R</b> or <b>D</b>.</p> <p>► Shift the transmission to position <b>P</b> or <b>N</b>.</p>
Auxiliary Battery Malfunction	<p>The auxiliary battery for the automatic transmission is no longer being charged.</p> <p>► Visit a qualified specialist workshop at the next opportunity.</p> <p>► Until then, set the automatic transmission to <b>P</b> before you switch off the engine.</p> <p>► Before leaving the vehicle, apply the parking brake.</p>
Apply Brake to Shift from 'P'	<p>You attempted to shift the transmission to position <b>D</b>, <b>R</b> or <b>N</b> without depressing the brake pedal.</p> <p>► Depress the brake pedal.</p>
Apply Brake to Select R	<p>You have attempted to shift from position <b>D</b> to position <b>R</b> without applying the brakes.</p> <p>► Depress the brake pedal.</p> <p>► Shift the transmission to position <b>R</b>.</p>
	<p>The rear door is open.</p> <p><b>⚠ WARNING</b></p> <p>When the engine is running, exhaust gases can enter the vehicle interior if the rear door is open. There is a risk of poisoning.</p> <p>► Close the rear door.</p>
	<p>The hood is open.</p> <p>A warning tone also sounds.</p> <p><b>⚠ WARNING</b></p> <p>The open hood may block your view when the vehicle is in motion. There is a risk of an accident.</p> <p>► Pull over and stop the vehicle safely as soon as possible, paying attention to road and traffic conditions.</p> <p>► Secure the vehicle against rolling away (▷ page 122).</p> <p>► Close the hood.</p>
	<p>At least one door is open.</p> <p>A warning tone also sounds.</p> <p>► Close all the doors.</p>



Display messages	Possible causes/consequences and ► Solutions
 <p>Power Steering Malfunction See Operator's Manual</p>	<p>The power steering is malfunctioning. A warning tone also sounds.</p> <p> <b>WARNING</b></p> <p>You will need to use more force to steer. There is a risk of an accident.</p> <ul style="list-style-type: none"> <li>► Check whether you are able to apply the extra force required.</li> <li>► <b>If you are able to steer safely:</b> carefully drive on to a qualified specialist workshop.</li> <li>► <b>If you are unable to steer safely:</b> do not drive on. Contact the nearest qualified specialist workshop.</li> </ul>
<p>Phone No Service</p>	<p>Your vehicle is outside the network provider's transmitter/receiver range.</p> <ul style="list-style-type: none"> <li>► Wait until the mobile phone operational readiness symbol appears in the multifunction display.</li> </ul>
 <p>Check Washer Fluid</p>	<p>The washer fluid level in the washer fluid reservoir has dropped below the minimum.</p> <ul style="list-style-type: none"> <li>► Add washer fluid (&gt; page 234).</li> </ul>

### SmartKey

Display messages	Possible causes/consequences and ► Solutions
 <p>Key Does Not Belong to Vehicle</p>	<p>You have put the wrong SmartKey in the ignition lock.</p> <ul style="list-style-type: none"> <li>► Use the correct SmartKey.</li> </ul>
 <p>Take Your Key from Ignition</p>	<p>The SmartKey is in the ignition lock.</p> <ul style="list-style-type: none"> <li>► Remove the SmartKey.</li> </ul>
 <p>Obtain a New Key</p>	<p>The SmartKey needs to be replaced.</p> <ul style="list-style-type: none"> <li>► Visit a qualified specialist workshop.</li> </ul>

### Warning and indicator lamps in the instrument cluster

#### General notes

Some systems carry out a self-diagnosis when the ignition is switched on. Therefore, some

indicator and warning lamps may light up or flash temporarily. This behavior is non-critical. These indicator and warning lamps only indicate a malfunction if they light up or flash after starting the engine or whilst driving.

## Safety

## Seat belts

Warning/  
indicator  
lamp

## ▷ Signal type

## Possible causes/consequences and ▶ Solutions



▷ After starting the engine, the red seat belt warning lamp lights up for 6 seconds. The seat belt warning lamp reminds the driver and front passenger to fasten their seat belts.

- ▶ Fasten your seat belt (▷ page 41).



▷ After starting the engine, the red seat belt warning lamp lights up. In addition, a warning tone sounds for up to 6 seconds. The driver's seat belt is not fastened.

- ▶ Fasten your seat belt (▷ page 41).  
The warning tone ceases.



▷ The red seat belt warning lamp lights up after the engine starts, as soon as the driver's or the front-passenger door is closed. The driver or front passenger has not fastened their seat belt.

- ▶ Fasten your seat belt (▷ page 41).  
The warning lamp goes out.

There are objects on the front-passenger seat.

- ▶ Remove the objects from the front-passenger seat and stow them in a secure place.  
The warning lamp goes out.



▷ The red seat belt warning lamp flashes and an intermittent audible warning sounds.













The driver or front passenger has not fastened their seat belt. The vehicle is being driven faster than 15 mph (25 km/h) or has briefly been driven faster than 15 mph (25 km/h).

- ▶ Fasten your seat belt (▷ page 41).  
The warning lamp goes out and the intermittent warning tone ceases.

There are objects on the front-passenger seat. The vehicle is being driven faster than 15 mph (25 km/h) or has briefly been driven faster than 15 mph (25 km/h).

- ▶ Remove the objects from the front-passenger seat and stow them in a secure place.  
The warning lamp goes out and the intermittent warning tone ceases.

## Safety systems

Warning/ indicator lamp	▷ Signal type Possible causes/consequences and ▶ Solutions
	<p>▷ <b>Canada only:</b> the red brake system warning lamp is on while the engine is running. A warning tone also sounds.</p> <p> <b>WARNING</b></p> <p>The brake system is malfunctioning and the braking characteristics may be affected. There is a risk of an accident.</p> <ul style="list-style-type: none"> <li>▶ If the multifunction display shows a display message, please observe this.</li> <li>▶ Drive on carefully.</li> <li>▶ Visit a qualified specialist workshop.</li> </ul>
 	<p>▷  (USA only): the red brake system warning lamp is on while the engine is running.</p> <p> (Canada only): the yellow brake system warning lamp is lit while the engine is running. A warning tone also sounds.</p> <p> <b>WARNING</b></p> <p>The brake boosting effect is malfunctioning and the braking characteristics may be affected. There is a risk of an accident.</p> <ul style="list-style-type: none"> <li>▶ Pull over and stop the vehicle safely as soon as possible, paying attention to road and traffic conditions. Do not continue driving under any circumstances.</li> <li>▶ Secure the vehicle against rolling away (▷ page 122).</li> <li>▶ Consult a qualified specialist workshop.</li> <li>▶ Observe the additional display messages in the multifunction display.</li> </ul>
 	<p>▷  (USA only): the red brake system warning lamp is on while the engine is running.</p> <p> (Canada only): the yellow brake system warning lamp is lit while the engine is running. A warning tone also sounds. There is not enough brake fluid in the brake fluid reservoir.</p> <p> <b>WARNING</b></p> <p>The braking effect may be impaired. There is a risk of an accident.</p> <ul style="list-style-type: none"> <li>▶ Pull over and stop the vehicle safely as soon as possible, paying attention to road and traffic conditions. Do not continue driving under any circumstances.</li> <li>▶ Secure the vehicle against rolling away (▷ page 122).</li> <li>▶ Do not add brake fluid. Adding more will not correct the malfunction.</li> <li>▶ Consult a qualified specialist workshop.</li> <li>▶ Observe the additional display messages in the multifunction display.</li> </ul>

**Warning/  
indicator  
lamp****▷ Signal type****Possible causes/consequences and ► Solutions**

▷ **PARK** (USA only): the red parking brake warning lamp is lit while the vehicle is in motion.

**(P)** (Canada only): the red parking brake warning lamp is lit while the vehicle is in motion.

You are driving with the parking brake applied.

- Release the parking brake.  
The warning lamp goes out and the warning tone ceases.



▷ The yellow ABS warning lamp is lit while the engine is running.

ABS (anti-lock braking system) is malfunctioning.

If there is an additional warning tone, the EBD (electronic brake force distribution) is malfunctioning.

Other driving systems and driving safety systems may also malfunction.

**⚠ WARNING**

The brake system continues to function normally, but without the functions listed above. The front and rear wheels could therefore lock if you brake hard, for example.

The steerability and braking characteristics may be severely affected. The braking distance in an emergency braking situation can increase.

If ESP® is not operational, ESP® is unable to stabilize the vehicle.

There is an increased risk of skidding and an accident.

- Observe the additional display messages in the multifunction display.
- Drive on carefully.
- Visit a qualified specialist workshop immediately.

If the ABS control unit is faulty, there is also a possibility that other systems, such as the navigation system or the automatic transmission, will not be available.

**Warning/  
indicator  
lamp****▷ Signal type****Possible causes/consequences and ▶ Solutions**

▷ The yellow ABS warning lamp is lit while the engine is running. ABS is temporarily unavailable.

Other driving and driving safety systems may also be unavailable.

Possible causes are:

- Self-diagnosis is not yet complete.
- The on-board voltage may be insufficient.

**⚠ WARNING**

The brake system continues to function normally, but without the functions listed above. The wheels could therefore lock if you brake hard, for example.

The steerability and braking characteristics may be severely affected. The braking distance in an emergency braking situation can increase.

If ESP® is not operational, ESP® is unable to stabilize the vehicle.

There is a risk of an accident.

- ▶ Carefully drive on a suitable stretch of road, making gentle steering movements at speeds of above 12 mph (20 km/h).  
The functions mentioned above are available again when the warning lamp goes out.

If the warning lamp is still on:

- ▶ Observe the additional display messages in the multifunction display.
- ▶ Drive on carefully.
- ▶ Visit a qualified specialist workshop.



▷ The yellow ABS warning lamp is lit while the engine is running. You have engaged the differential locks. ABS is deactivated.

- ▶ Disengage the differential locks.  
Subsequently ABS is reactivated.

Warning/  
indicator  
lamp

## ▷ Signal type

## Possible causes/consequences and ► Solutions



▷ **BRAKE** (USA only): the red brake system warning lamp and the yellow ESP® and ABS warning lamps are on while the engine is running.

 (Canada only): the yellow brake system, ESP® and ABS warning lamps are on while the engine is running.

ABS and ESP® are malfunctioning.

Other driving systems and driving safety systems may also malfunction.

 **WARNING**

The brake system continues to function normally, but without the functions listed above. The front and rear wheels could therefore lock if you brake hard, for example.

The steerability and braking characteristics may be severely affected. The braking distance in an emergency braking situation can increase.

If ESP® is not operational, ESP® is unable to stabilize the vehicle.

There is an increased risk of skidding and an accident.

- ▶ Observe the additional display messages in the multifunction display.
- ▶ Drive on carefully.
- ▶ Visit a qualified specialist workshop immediately.



▷ The yellow ESP® warning lamp flashes while the vehicle is in motion.

ESP® or traction control has intervened because there is a risk of skidding or at least one wheel has started to spin.

Cruise control or DISTRONIC PLUS is deactivated.

- ▶ When pulling away, only depress the accelerator pedal as far as necessary.
- ▶ Ease off the accelerator pedal while the vehicle is in motion.
- ▶ Adapt your driving style to suit the road and weather conditions.
- ▶ Do not deactivate ESP®.

In rare cases (▷ page 59), it may be best to deactivate ESP®.

Observe the important safety notes on ESP® (▷ page 59).

**Warning/  
indicator  
lamp****▷ Signal type  
Possible causes/consequences and ▶ Solutions**

▷ The yellow ESP<sup>®</sup> OFF warning lamp is lit while the engine is running. ESP<sup>®</sup> is deactivated.

**⚠ WARNING**

If ESP<sup>®</sup> is switched off, ESP<sup>®</sup> is unable to stabilize the vehicle. Further driving systems or driving safety systems are thus restricted. There is an increased risk of skidding and an accident.

- ▶ Reactivate ESP<sup>®</sup>.  
In rare cases (▷ page 59), it may be best to deactivate ESP<sup>®</sup>.  
Observe the important safety notes on ESP<sup>®</sup> (▷ page 59).
- ▶ Adapt your driving style to suit the road and weather conditions.

If ESP<sup>®</sup> cannot be activated:

- ▶ Drive on carefully.
- ▶ Have ESP<sup>®</sup> checked at a qualified specialist workshop.



▷ The yellow ESP<sup>®</sup> and ESP<sup>®</sup> OFF warning lamps are lit while the engine is running. ESP<sup>®</sup> is malfunctioning. Other driving systems and driving safety systems may also malfunction.

**⚠ WARNING**

The brake system continues to function normally, but without the functions listed above.

The braking distance in an emergency braking situation can thus increase.

If ESP<sup>®</sup> is not operational, ESP<sup>®</sup> is unable to stabilize the vehicle.

There is an increased risk of skidding and an accident.

- ▶ Observe the additional display messages in the multifunction display.
- ▶ Drive on carefully.
- ▶ Visit a qualified specialist workshop immediately.

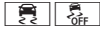
**Warning/  
indicator  
lamp****▷ Signal type****Possible causes/consequences and ► Solutions**

▷ The yellow ESP<sup>®</sup> and ESP<sup>®</sup> OFF warning lamps are lit while the engine is running. ESP<sup>®</sup> is temporarily unavailable.

Other driving and driving safety systems may also be unavailable.

**⚠ WARNING**

The brake system continues to function normally, but without the functions listed above.

The braking distance in an emergency braking situation can thus increase.

If ESP<sup>®</sup> is not operational, ESP<sup>®</sup> is unable to stabilize the vehicle.

There is an increased risk of skidding and an accident.

► Carefully drive on a suitable stretch of road, making gentle steering movements at speeds of above 12 mph (20 km/h).

The functions mentioned above are available again when the warning lamp goes out.

If the warning lamp is still on:

- Observe the additional display messages in the multifunction display.
- Drive on carefully.
- Visit a qualified specialist workshop.



▷ The yellow ESP<sup>®</sup> OFF warning lamp is lit while the engine is running.

The differential lock is engaged. ABS, ESP<sup>®</sup>, 4ETS and BAS have been deactivated.

► Disengage the differential lock.

ESP<sup>®</sup>, 4ETS and BAS are subsequently reactivated.

► Observe the additional display messages in the multifunction display.



▷ The red restraint system warning lamp is lit while the engine is running.

The restraint system is malfunctioning.

**⚠ WARNING**

The air bags or Emergency Tensioning Devices may either be triggered unintentionally or, in the event of an accident, may not be triggered.

There is an increased risk of injury.

- Observe the additional display messages in the multifunction display.
- Drive on carefully.
- Contact a qualified specialist workshop and have the restraint system checked.

For further information about the restraint system, see (▷ page 38).



## Engine

Warning/  
indicator  
lamp

## ▷ Signal type

## Possible causes/consequences and ▶ Solutions



▷ The yellow Check Engine warning lamp lights up while the engine is running. There may be a malfunction, for example:

- in the engine management
- in the fuel injection system
- in the exhaust system
- in the ignition system
- in the fuel system

The emission limit values may be exceeded and the engine may be in emergency mode.

▶ Visit a qualified specialist workshop immediately.

In some states, you must immediately visit a qualified specialist workshop as soon as the yellow Check Engine warning lamp lights up. This is due to the legal requirements in effect in these states. If in doubt, check whether such legal regulations apply in the state in which you are currently driving.



▷ The yellow reserve fuel warning lamp lights up while the engine is running. The fuel level has dropped into the reserve range.

▶ Refuel at the nearest gas station.



▷ The yellow reserve fuel warning lamp flashes while the vehicle is in motion. In addition, the  Check Engine warning lamp may light up. The fuel filler cap is not closed correctly or the fuel system is leaking.

▶ Check that the fuel filler cap is correctly closed.

▶ **If the fuel filler cap is not correctly closed:** close the fuel filler cap.

▶ **If the fuel filler cap is closed:** visit a qualified specialist workshop.



▷ The red coolant warning lamp lights up while the engine is running and the coolant temperature gauge is at the start of the scale.

The temperature sensor for the coolant temperature gauge is malfunctioning.

The coolant temperature is no longer being monitored. There is a risk of engine damage if the coolant temperature is too high.

▶ Pull over and stop the vehicle safely and switch off the engine, paying attention to road and traffic conditions. Do not continue driving under any circumstances.

▶ Secure the vehicle against rolling away (▷ page 122).

▶ Consult a qualified specialist workshop.

Warning/  
indicator  
lamp

## ▷ Signal type

## Possible causes/consequences and ► Solutions



▷ The red coolant warning lamp comes on while the engine is running.

The coolant level is too low.

If the coolant level is correct, the airflow to the engine radiator may be blocked or the electric engine radiator fan may be defective.

The coolant is too hot and the engine is no longer being cooled sufficiently.

- ▶ Observe the additional display messages in the multifunction display.
- ▶ Pull over and stop the vehicle safely and switch off the engine, paying attention to road and traffic conditions.
- ▶ Secure the vehicle against rolling away (▷ page 122).
- ▶ Leave the vehicle and keep a safe distance from the vehicle until the engine has cooled down.
- ▶ Check the coolant level and add coolant, observing the warning notes (▷ page 234).
- ▶ If you have to add coolant frequently, have the engine cooling system checked.
- ▶ Make sure that the air supply to the engine radiator is not blocked, e.g. by snow, slush or ice.
- ▶ Do not start the engine again until the coolant temperature gauge is below the **H** marking (▷ page 161). Otherwise, the engine could be damaged.
- ▶ Drive to the nearest qualified specialist workshop.
- ▶ Avoid heavy loads on the engine as you do so, e.g. driving in mountainous terrain and stop-and-go traffic.



▷ The red coolant warning lamp comes on while the engine is running.

The coolant temperature gauge has exceeded the **H** marking (▷ page 161). The airflow to the engine radiator may be blocked or the coolant level may be too low.

 **WARNING**

The engine is not being cooled sufficiently and may be damaged.

Do not drive when your engine is overheated. This can cause some fluids which may have leaked into the engine compartment to catch fire.

Steam from the overheated engine can also cause serious burns which can occur just by opening the hood.

There is a risk of injury.

- ▶ Observe the additional display messages in the multifunction display.
- ▶ Pull over and stop the vehicle safely and switch off the engine, paying attention to road and traffic conditions.
- ▶ Secure the vehicle against rolling away (▷ page 122).
- ▶ Leave the vehicle and keep a safe distance from the vehicle until the engine has cooled down.
- ▶ Check the coolant level and add coolant, observing the warning notes (▷ page 234).
- ▶ If you have to add coolant frequently, have the engine cooling system checked.
- ▶ Make sure that the air supply to the engine radiator is not blocked, e.g. by snow, slush or ice.

**Warning/  
indicator  
lamp**▷ **Signal type****Possible causes/consequences and ▶ Solutions**

- ▶ If the coolant temperature gauge is below the **H** marking (▷ page 161), drive on to the next qualified specialist workshop.
- ▶ Avoid heavy loads on the engine as you do so, e.g. driving in mountainous terrain and stop-and-go traffic.

**Driving systems****Warning/  
indicator  
lamp**▷ **Signal type****Possible causes/consequences and ▶ Solutions**

▷ The red distance warning lamp lights up while the vehicle is in motion. A warning tone also sounds.

You are approaching a vehicle or a stationary obstacle in your line of travel at too high a speed.

- ▶ Be prepared to brake immediately.
- ▶ Pay careful attention to the traffic situation. You may have to brake or take evasive action.

Further information on DISTRONIC PLUS (▷ page 134).

## Tires

Warning/  
indicator  
lamp

## ▷ Signal type

## Possible causes/consequences and ▶ Solutions



▷ The yellow tire pressure monitor warning lamp (pressure loss/malfunction) is lit. The tire pressure monitor has detected a loss of pressure in at least one of the tires.

 **WARNING**

Tire pressures that are too low pose the following hazards:

- they may burst, especially as the load and vehicle speed increase.
  - they may wear excessively and/or unevenly, which may greatly impair tire traction.
  - the driving characteristics, as well as steering and braking, may be greatly impaired  
There is a risk of an accident.
- ▶ Stop the vehicle without making any sudden steering or braking maneuvers. Pay attention to the traffic conditions as you do so.
- ▶ Secure the vehicle against rolling away (▷ page 122).
- ▶ Observe the additional display messages in the multifunction display.
- ▶ Check the tires and, if necessary, follow the instructions for a flat tire (▷ page 246).
- ▶ Check the tire pressure (▷ page 263).
- ▶ If necessary, correct the tire pressure.



▷ The yellow tire pressure monitor warning lamp (pressure loss/malfunction) flashes for approximately one minute and then remains lit.

The tire pressure monitor is faulty.

 **WARNING**

The system is possibly unable to recognize or register low tire pressure. There is a risk of an accident.

- ▶ Observe the additional display messages in the multifunction display.
- ▶ Visit a qualified specialist workshop immediately.

### General notes

The multimedia system section in this Operator's Manual describes the basic principles for operation. More information can be found in the Digital Operator's Manual.

### Important safety notes

#### WARNING

If you operate information systems and communication equipment integrated in the vehicle when driving, you may be distracted from the traffic situation. You could also lose control of the vehicle. There is a risk of an accident.

Only operate this equipment when the traffic situation permits. If you are not sure that this is possible, park the vehicle paying attention to traffic conditions and operate the equipment when the vehicle is stationary.

You must observe the legal requirements for the country in which you are currently driving when operating the multimedia system.

The multimedia system calculates the route to the destination without taking the following into account, for example:

- traffic lights
- stop and yield signs
- parking or stopping restrictions
- road narrowing
- other road and traffic rules and regulations

The multimedia system may give incorrect navigation recommendations if the actual street/traffic situation does not correspond with the digital map's data.

For example:

- a diverted route
- the road layout or the direction of a one-way street has been changed

For this reason, you must always observe road and traffic rules and regulations during your journey. Road and traffic rules and regulations always have priority over multimedia system driving recommendations.

Navigation announcements are intended to direct you while driving without diverting your attention from the road and driving.

Please always use this feature instead of consulting the map display for directions. Looking at the icons or map display can distract you from traffic conditions and driving, and increase the risk of an accident.

This equipment complies with FCC radiation exposure limits set forth for uncontrolled equipment and meets the FCC radio frequency (RF) Exposure Guidelines in Supplement C to OET65.

This equipment has very low levels of RF energy that is deemed to comply without maximum permissive exposure evaluation (MPE). However, it is recommended to install it at a distance of at least 8 inches (approx. 20 cm) between the radiation source and a person's body (not including limbs such as hands, wrists, feet and legs).

#### WARNING

Modifications to electronic components, their software as well as wiring can impair their function and/or the function of other networked components. In particular, systems relevant to safety could also be affected. As a result, these may no longer function as intended and/or jeopardize the operating safety of the vehicle. There is an increased risk of an accident and injury.

Never tamper with the wiring as well as electronic components or their software. You should have all work to electrical and electronic equipment carried out at a qualified specialist workshop.

### Function restrictions

For safety reasons, some functions are restricted or unavailable while the vehicle is in motion. You will notice this, for example, because either you will not be able to select certain menu items or a message will appear to this effect.

## Operating system

### Overview

#### General notes

**!** Do not use the space in front of the display for storage. Objects placed here could damage the display or impair its function. Avoid any direct contact with the display surface. Pressure on the display surface may result in impairments to the display, which could be irreversible.

Wearing polarized sunglasses may impair your ability to read the display.

The display has an automatic temperature-controlled switch-off feature. The brightness is automatically reduced if the temperature is too high. The display may temporarily switch off completely.

#### Cleaning instructions

**!** Do not touch the display. The display has a very sensitive high-gloss surface; there is a risk of scratching. If you have to clean the screen, however, use a mild cleaning agent and a soft, lint-free cloth.

The display must be switched off and have cooled down before you start cleaning. Do not apply pressure to the display surface when cleaning it, as this could cause irreversible damage to the display.

#### Switching the multimedia system on/off

► Press the  control knob.



#### Adjusting the volume

► Turn the  control knob.

The volume is adjusted:

- for the currently selected media source
- during traffic or navigation announcements
- in hands-free mode during an active call

#### Switching the sound on or off

► Press the  button on the control panel. If the audio output is switched off, the status line will show the  symbol. If you switch

the media source or set the volume, the sound is automatically switched on.

**i** Navigation announcements will be heard even if the sound is muted.

#### Functions

The multimedia system has the following functions:





- Radio mode
- Media mode with media search
- Sound systems
- Navigation system
- Communication functions
- SIRIUS Weather
- Vehicle functions with system settings
- Favorites functions

#### Controller

The controller in the center console lets you:

- select menu items on the display
- enter characters
- select a destination on the map
- save entries

The controller can be:

- turned 
- slid left or right 
- slid forwards or back 
- slid diagonally 
- pressed briefly or pressed and held 

#### Back button

You can use the  button to exit a menu or to call up the main menu of the current operating mode.

► **To exit the menu:** briefly press the  button.

The multimedia system changes to the next higher menu level in the current operating mode.

► **To call up the main menu:** press the  button for longer than two seconds.



The multimedia system changes to the main menu of the current operating mode.

## Favorites button

You can assign predefined functions using the  favorites button and call them up by pressing the button (▷ page 205).



### Favorites

#### Calling up and exiting favorites

- ▶ **To call up:** press the  button on the controller.
- ▶ Select a favorite, e.g. **Vehicle**.  
The favorites are displayed.
- ▶ **To exit:** press the  button again.

#### Adding favorites

##### Adding predefined favorites

- ▶ Press the  button.
- ▶ Slide  the controller.
- ▶ Select **Reassign**.  
The categories are displayed.
- ▶ Select a category.  
The favorites are displayed.
- ▶ Select a favorite.
- ▶ To add the favorite to the desired position, turn and press the controller.  
If a favorite has already been added at this position, it will be overwritten.

##### Adding your own favorites

You can add climate control as a favorite, for example.

- ▶ Select **Vehicle** → **Vehicle Settings**.
- ▶ Press and hold the  button until the favorites are displayed.
- ▶ Add a favorite to the desired position.  
If a favorite has already been added at this position, it will be overwritten.

### Navigation mode

#### Important safety notes

##### **WARNING**

If you operate information systems and communication equipment integrated in the vehicle when driving, you may be distracted from

the traffic situation. You could also lose control of the vehicle. There is a risk of an accident.

Only operate this equipment when the traffic situation permits. If you are not sure that this is possible, park the vehicle paying attention to traffic conditions and operate the equipment when the vehicle is stationary.

You must observe the legal requirements for the country in which you are currently driving when operating the navigation system.

#### General notes

Among other things, correct functioning of the navigation system depends on GPS reception. In certain situations, GPS reception may be impaired, there may be interference or there may be no reception at all, e.g. in tunnels or parking garages.

Further information can be found in the Digital Operator's Manual.

#### Selecting a route type and route options

Multimedia system:

- ▶ Select **Navi** → **Navigation**.  
The map shows the vehicle's current position.
- ▶ Slide  the controller.
- ▶ Select **Options** → **Route Settings**.

Notes for route types:

- **Eco Route**
- **Dynamic Traffic Route**  
Traffic reports on the route for the route guidance are taken into account (not available in all countries).
- **Dynamic TRF. Route After Request**  
You can decide whether or not current traffic reports should be included in the route calculation (not available in all countries).
- **Calculate Alternative Routes**  
Different routes are being calculated. In order to do so, instead of **Start**, select the menu item **Continue**.
- ▶ **To avoid/use route options:** select **Avoid Options**.
- ▶ Select a route option.

Notes for route options:



- **Use Toll Roads**  
The route calculation includes roads which require you to pay a usage fee (toll).
- **Number of Occupants in the Vehicle:** (only available in the USA)  
Prerequisite: your vehicle meets the access conditions for carpool lanes.  
Carpool lanes will be included if the carpool lanes option is activated.

### Entering an address

Multimedia system:

- ▶ Select **Navi** → **Navigation**.  
The map shows the vehicle's current position.
- ▶ Slide  the controller.
- ▶ Select **Destination** → **Address Entry**.

Enter an address, e.g. as follows:

- city or ZIP code, street, house number
- state/province, city or ZIP code
- city or ZIP code, center
- street, city or ZIP code, intersection
- ▶ Select **City**.  
The city in which the vehicle is currently located (current vehicle position) is at the top. Below this, you will see locations for which route guidance has already been carried out.
- ▶ Enter the city.  
The  symbol: the location is contained on the digital map multiple times.
- ▶ **To switch to the list:** slide  the controller.
- ▶ Select the location.  
If available, the ZIP code is shown. If there are different ZIP codes available for the location, the corresponding digits are displayed with an **X**.
- ▶ Enter the street and house number.  
The address is in the menu.

### Further options for destination entry:

- search for a keyword  
The keyword search finds destinations using fragments of words.
- select the last destination
- select a contact
- select a POI  
You can search for a POI by location, name or telephone number.

- select destination on the map
- enter intermediate destination  
You can map the route to the destination yourself with up to four intermediate destinations.
- select destinations from Mercedes-Benz Apps
- select geo-coordinates

### Calculating the route

Prerequisite: the address has been entered and is in the menu.

- ▶ Select **Start** or **Continue**.  
The route is calculated with the selected route type and the selected route options.  
If route guidance has already been activated, a prompt will appear asking whether you wish to end the current route guidance.
- ▶ Select **Cancel Active Route Guidance** or **Set as Intermediate Destination**.  
**Cancel Active Route Guidance** cancels the current route guidance and starts route calculation to the new destination.  
**Set as Intermediate Destination** adds the new destination in addition to the existing destination and opens the intermediate destinations list.

### Connecting a mobile phone (COMAND)

#### Requirements

For telephony via the Bluetooth® interface, you require a Bluetooth®-capable mobile phone. The mobile phone must support Hands-Free Profile 1.0 or above.

Multimedia system:

- ▶ Select **Vehicle** → **System Settings** → **Activate Bluetooth**.
- ▶ Activate Bluetooth® .

Mobile phone:

- ▶ Activate Bluetooth® and, if necessary, Bluetooth® visibility for other devices (see the manufacturer's operating instructions).

The Bluetooth® device names for all of one manufacturer's products might be identical. To make it possible to clearly identify your mobile



phone, change the device name (see the manufacturer's operating instructions).

If the mobile phone supports the PBAP (Phone Book Access Profile) and MAP (Message Access Profile) Bluetooth® profiles, the following information will be transmitted after you connect:

- Phone book
- Call lists
- Text messages and e-mail

**i** Further information on suitable mobile phones can be found at: <http://www.mercedes-benz.com/connect>

**i** In the USA, you can get in touch with the Mercedes-Benz Customer Assistance Center on 1-800-FOR-MERCEdes (1-800-367-6372). In Canada, you can get in touch with the Customer Relations Center on 1-800-387-0100.

### Searching for and authorizing (connecting) a mobile phone

Before using your mobile phone with the multimedia system for the first time, you will need to search for the phone and then authorize (connect) it. Depending on the mobile phone, authorization either takes place by means of Secure Simple Pairing or by entering a passkey. The multimedia system automatically makes the procedure that is relevant for your mobile phone available. The mobile phone is always connected automatically after authorization. Further information on using a mobile phone with the multimedia system (see the Digital Operator's Manual).

If the multimedia system does not detect your mobile phone, this may be due to particular security settings on your mobile phone (see the manufacturer's operating instructions).



Only one mobile phone can be connected to the multimedia system at any one time.

#### Searching for a mobile phone

Multimedia system:

- ▶ Select **Tel/🌐** → **Conn. Device** → **Search for Phones** → **Start Search**.  
The available mobile phones are displayed.

#### Symbols in the device list

Symbol	Explanation
	New mobile phone found, not yet authorized.
	Mobile phone is authorized, but is not connected.
•	Mobile phone is authorized and connected.

#### Connecting a mobile phone

Authorization using Secure Simple Pairing:

- ▶ Select mobile phone.  
A code is displayed in the multimedia system and on the mobile phone.
- ▶ **If codes match:** select **Yes** on the multimedia system.
- ▶ Confirm code on the mobile phone. Depending on the mobile phone used, confirm the connection to the multimedia system and for the PBAP and MAP Bluetooth® profiles. The prompt to confirm may take up to two minutes to be displayed (see the manufacturer's operating instructions).
- ▶ **If the codes are different:** select **No** on the multimedia system.  
The process is canceled.  
Repeat authorization.

Authorization by entering a passkey (passcode):

- ▶ Select the Bluetooth® name of the mobile phone.  
The input menu for the passkey is displayed.
- ▶ Choose a one to sixteen-digit number combination as a passkey.
- ▶ Enter the passkey on the multimedia system.
- ▶ Press **OK** to confirm.
- ▶ Enter and confirm the passkey on the mobile phone. Depending on the mobile phone used, confirm the connection to the multimedia system and for the PBAP and MAP Bluetooth® profiles. The prompt to confirm may take up to two minutes to be displayed (see the manufacturer's operating instructions).

## Media mode

### General notes

If you wish to play external media sources, the appropriate media mode must already be turned on. Further information on media mode (see the Digital Operator's Manual).

The following external media sources can be used:

- Apple® devices (e.g. iPhone®)
- USB devices (e.g. USB stick, MP3 player) (▷ page 208)
- CD
- DVD video
- SD cards
- via devices connected by Bluetooth®

**i** Information on single CD/DVD drive or DVD changer (see the Digital Operator's Manual).

### Selecting using the device list

Multimedia system:

- ▶ Select **Media** → **Devices**.  
The available media sources will be shown.  
The ● dot indicates the current setting.
- ▶ Select the media source.  
Playable files are played.

### Inserting/removing an SD card

#### Important safety notes

##### **⚠ WARNING**

SD cards are small parts. They can be swallowed and cause choking. This poses an increased risk of injury or even fatal injury.  
Keep the SD card out of the reach of children.  
If a SD card is swallowed, seek medical attention immediately.

**!** If you are no longer using the SD card, you should remove it and store it outside the vehicle. High temperatures can damage the card.

#### Inserting an SD card

The SD card slot is located on the control panel.

- ▶ Insert the SD card into the SD card slot until the SD card engages. The side with the contacts must face down.

#### Removing an SD card

- ▶ Press the SD card.  
The SD card is ejected.
- ▶ Remove the SD card.

#### Connecting USB devices



- ▶ Connect the USB device to the USB port.  
There are two USB ports in the stowage space under the armrest.
- ▶ Select the media source (▷ page 208).

## Loading guidelines

### WARNING

If objects, luggage or loads are not secured or not secured sufficiently, they could slip, tip over or be flung around and thereby hit vehicle occupants. There is a risk of injury, particularly in the event of sudden braking or a sudden change in direction.

Always store objects so that they cannot be flung around. Secure objects, luggage or loads against slipping or tipping before the journey.

### WARNING

If you distribute the load unevenly in the vehicle, the handling as well as the steering and braking characteristics are severely affected. There is a risk of an accident.

Distribute the load evenly in the vehicle. Secure the load to prevent it from slipping.

### WARNING

The exhaust tail pipe and tail pipe trim can become very hot. If you come into contact with these parts of the vehicle, you could burn yourself. There is a risk of injury.

Always be particularly careful around the exhaust tail pipe and the tail pipe trim. Allow these components to cool down before touching them.

### WARNING

Combustion engines emit poisonous exhaust gases such as carbon monoxide. If the rear door is open when the engine is running, particularly if the vehicle is moving, exhaust fumes could enter the passenger compartment. There is a risk of poisoning.

Turn off the engine before opening the rear door. Never drive with the rear door open.

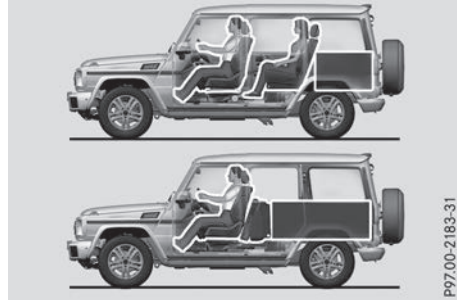

Driving, braking and steering characteristics change depending on:

- type of load
- weight
- the center of gravity of the load

You should therefore load your vehicle as shown in the illustrations.

The gross vehicle weight (GVW) is the vehicle weight including fuel, vehicle tool kit, spare wheel, accessories installed, vehicle occupants and luggage/load.

Do not exceed the load limit or permitted gross vehicle weight rating (GVWR) for your vehicle. The load limit and GVWR are given on the vehicle identification plate found on the driver's door B-pillar.

Furthermore, the load must be distributed in such a way that the weight on each axle never exceeds the gross axle weight rating (GAWR) for the front and rear axles. The relevant GVWR and GAWR information can be found on the vehicle identification plate on the driver's side B-pillar. Further information can be found in the "Loading the vehicle" section (▷ page 266).

Observe the following notes when transporting a load:

- Position heavy loads as far forward as possible and as low down in the cargo compartment as possible.
- Transport loads when possible in the cargo compartment. You should only use the cargo compartment enlargement if the load does not fit in the cargo compartment.

- Always place the load against the backrests of the front seats or rear seats.
- Use the cargo tie-down rings and the parcel nets to transport loads and luggage.
- Use cargo tie-down rings and fastening materials appropriate for the weight and size of the load.

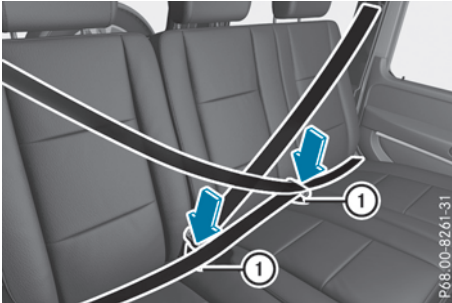

## Stowage and features

If the rear bench seat is not occupied:

- ▶ Insert the belt tongue on the outer seat belts into the buckle of opposite seat belt ①.
- ▶ Secure the load with sufficiently strong and wear-resistant tie downs.
- ▶ Pad sharp edges for protection.

## Stowage areas

### Stowage spaces

#### Important safety notes

#### **WARNING**

If you transport objects in the vehicle interior and these are not adequately secured, they could slip or be flung around and thereby strike vehicle occupants. In addition, cup holders, open stowage spaces and mobile phone brackets may not always be able to hold the objects placed in them in the event of an accident. There is a risk of injury, particularly in the event of sharp braking or sudden changes of direction.

- Always stow objects in such a way that they cannot be tossed about in these or similar situations.
- Always make sure that objects do not protrude out of the stowage spaces, luggage nets or stowage nets.
- Ensure that closable stowage spaces are shut before beginning your journey.
- Always stow and secure heavy, hard, pointed, sharp-edged, fragile or large objects in the cargo compartment.

Observe the loading guidelines (▶ page 209).

## Stowage compartments in the front

### Glove box

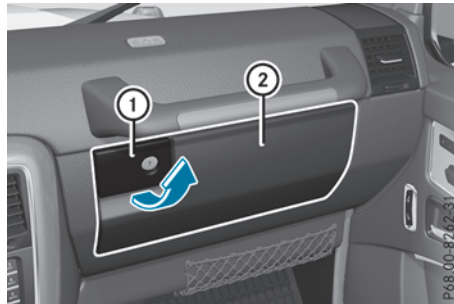

- ▶ **To open:** pull handle ① and open glove box flap ②.
- ▶ **To close:** fold glove box flap ② up until it engages.

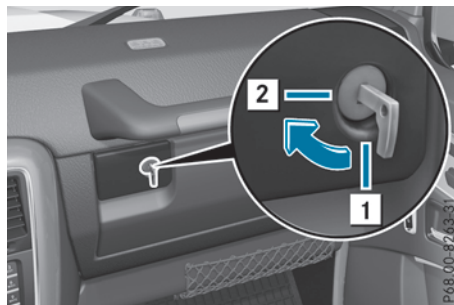

- ① Glove box unlocked
- ② Glove box locked

- ▶ **To lock:** insert the mechanical key into the lock (▷ page 64) and turn it 90° clockwise to position **1**.
- ▶ **To unlock:** insert the mechanical key into the lock (▷ page 64) and turn it 90° counter-clockwise to position **1**.

The glove box can only be locked and unlocked using the mechanical key.

### Door storage compartment

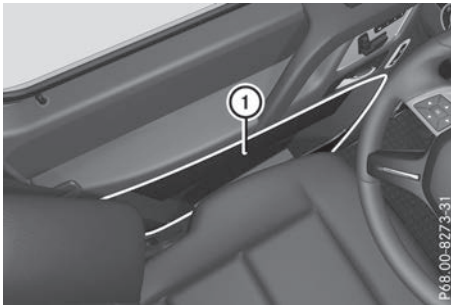

- ① Door storage compartment

There is an additional compartment located on the driver's door trim.

### Stowage compartment under the armrest in the center console

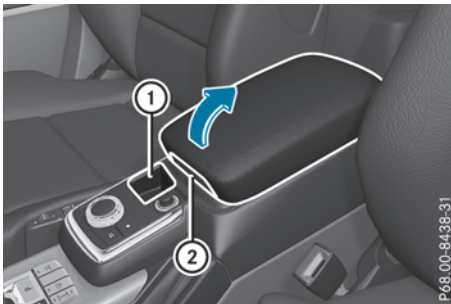

- ① Small stowage compartment
- ② Release button for the armrest
- ▶ **To open:** press release button **2**.
- ▶ Fold up armrest.
- ▶ **To close:** fold the armrest down. The armrest engages audibly.

## Stowage space in the rear

### Storage pockets

#### ⚠ WARNING

Storage bags are intended for storing light-weight items only.

Heavy objects, objects with sharp edges or fragile objects may not be transported in the storage bag. In an accident, during hard braking, or sudden maneuvers, they could be thrown around inside the vehicle and cause injury to vehicle occupants.

Storage bags cannot protect transported goods in the event of an accident.

The stowage pockets are located on the rear side of the front seats.

### Stowage nets

The following additional stowage areas are available in the vehicle:

- stowage net in the front-passenger footwell
- map pockets on the back of the driver's and front-passenger seat
- stowage net on the left-hand side in the cargo compartment

Observe the loading guidelines (▷ page 209) and the safety notes regarding stowage spaces (▷ page 210).

### Cargo compartment enlargement

## Important safety notes

#### ⚠ WARNING

If the rear bench seat/rear seat and seat backrest are not engaged they could fold forwards, e.g. when braking suddenly or in the event of an accident.

- The vehicle occupant would thereby be pushed into the seat belt by the rear bench seat/rear seat or by the seat backrest. The seat belt can no longer offer the intended

level of protection and could even cause injuries.

- Objects or loads in the trunk/cargo compartment cannot be restrained by the seat backrest.

There is an increased risk of injury.

Before every trip, make sure that the seat backrests and the rear bench seat/rear seat are engaged.

#### WARNING

Combustion engines emit poisonous exhaust gases such as carbon monoxide. If the rear door is open when the engine is running, particularly if the vehicle is moving, exhaust fumes could enter the passenger compartment. There is a risk of poisoning.

Turn off the engine before opening the rear door. Never drive with the rear door open.

- ❗ Ensure that you remove all containers from the cup holder in the rear before folding the seat backrest and the seat cushion of the rear bench seat forwards.

Observe the loading guidelines (▷ page 209).

The rear bench seat is split symmetrically.

The left-hand and right-hand rear bench seats can be folded forward to increase the capacity of the rear compartment. You can:

- fold the seat backrests forward
- fold the rear bench seat back fully

#### Folding the seat backrest forward

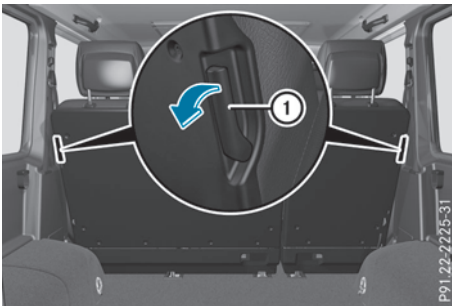

- ▶ Remove the head restraints (▷ page 77).

Head restraints may be removed and stowed, e.g. in the cargo compartment. Store head restraints so that they cannot be flung around.

- ▶ Pull release ① in the direction of the arrow. The corresponding seat backrest is released.
- ▶ Fold the backrest forward.

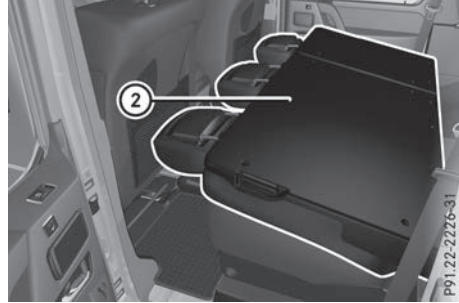

- ② Seat backrest folded forward

#### Folding the seat backrest back

- ❗ Make sure that the seat belt does not become trapped when folding the rear seat backrest back. Otherwise, it could be damaged.

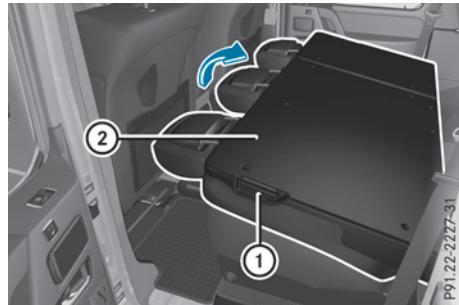

- ▶ Pull release lever ①. The corresponding seat backrest is released.
- ▶ Fold seat backrest ② back in the direction of the arrow until it engages.
- ▶ Install the head restraints (▷ page 77).

## Rear bench seat

### Folding the rear bench seat forward

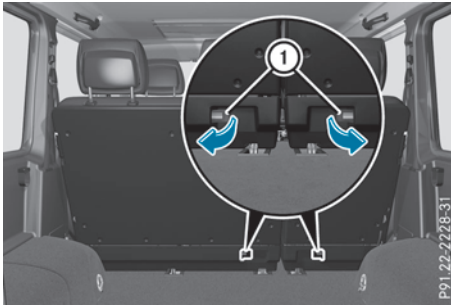

- ▶ Fold the backrest forward (▷ page 212).
- ▶ Pull the release in the direction of arrow ①. The corresponding rear bench seat is released.
- ▶ Fold rear bench seat ② forward.

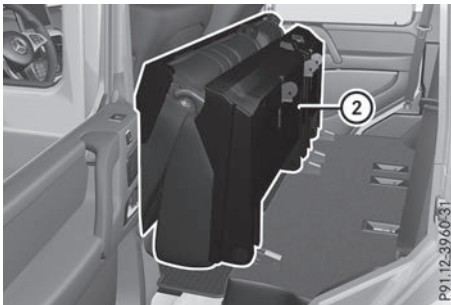

② Rear bench seat folded forward

### Folding the rear bench seat into an upright position

#### **WARNING**

If the rear bench seat/rear seat and seat backrest are not engaged they could fold forwards, e.g. when braking suddenly or in the event of an accident.

- The vehicle occupant would thereby be pushed into the seat belt by the rear bench seat/rear seat or by the seat backrest. The seat belt can no longer offer the intended

level of protection and could even cause injuries.

- Objects or loads in the trunk/cargo compartment cannot be restrained by the seat backrest.

There is an increased risk of injury.

Before every trip, make sure that the seat backrests and the rear bench seat/rear seat are engaged.

- ▶ Fold the rear bench seat back. The seat catch engages audibly.
- ▶ Fold the backrest back (▷ page 212).
- ▶ Install the head restraints (▷ page 77).

## Securing loads

### Important safety notes

Distribute the load on the cargo tie-down rings evenly.

Do not tamper with or repair cargo tie-down points, cargo tie-down rings or tie downs. Have maintenance work as well as modifications, installations and conversions carried out at a qualified specialist workshop (▷ page 27).

Observe the following notes on securing loads:

- Observe the loading guidelines (▷ page 209).
- Secure the load using the cargo tie-down rings.
- Distribute the load on the cargo tie-down rings evenly.
- Do not use elastic straps or nets to secure a load, as these are only intended as an anti-slip protection for light loads.
- Do not route tie-downs across sharp edges or corners.
- Pad sharp edges for protection.
- Only use tie downs that have been checked in accordance with applicable standards, e.g. lashing nets or lashing straps.
- Fill the spaces between the load and the cargo compartment walls and the wheel housing in a form-locking way. Only use dimensionally stable transportation aids for this, such as chocks, wooden fixings or padding.

### Cargo tie-down rings in the cargo compartment

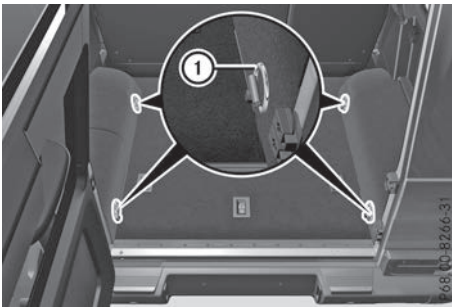

- ① Cargo tie-down rings in the cargo compartment

### Cargo compartment cover

#### Important safety notes

#### WARNING

On its own, the cargo compartment cover cannot secure or restrain heavy objects, items of luggage and heavy loads. You could be hit by an unsecured load during sudden changes in direction, braking or in the event of an accident. There is an increased risk of injury or even fatal injury.

Always store objects so that they cannot be flung around. Secure objects, luggage or loads against slipping or tipping over, e.g. by using tie downs, even if you are using the cargo compartment cover.

- ❗ When loading the vehicle, make sure that you do not stack the load in the cargo compartment higher than the lower edge of the side windows. Do not place heavy objects on top of the cargo compartment cover.

The cargo compartment cover is secured behind the rear bench seat backrest.

### Opening and closing the cargo compartment cover

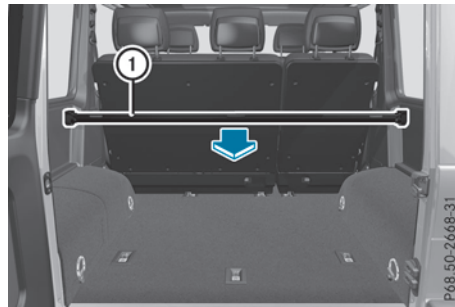

- ▶ **To open:** pull cargo compartment cover ① back and clip it into the retainers on the left and right of the rear door.
- ▶ **To close:** unclip cargo compartment cover ① and guide it forward until it is completely rolled up.

### Installing/removing the cargo compartment cover

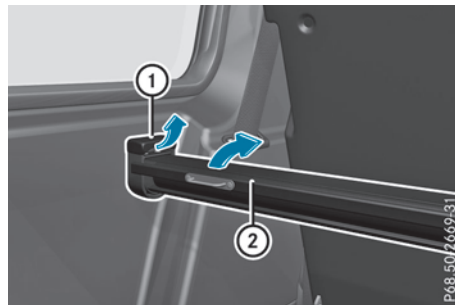

- ▶ **To remove:** make sure that cargo compartment cover ② is rolled up.
- ▶ Slide catch ① on both sides to the center of the vehicle.
- ▶ Swing cargo compartment cover ② up.
- ▶ **To install:** slide catches ① to the center of the vehicle.
- ▶ Insert cargo compartment cover ② into the recesses of the side trim panel.
- ▶ Press the left and right-hand side of cargo compartment cover ② down until the cargo compartment cover engages.
- ▶ Slide catches ① towards the side trim panel.



## Features

### Cup holder

#### Important safety notes

##### WARNING

If you transport objects in the vehicle interior and these are not adequately secured, they could slip or be flung around and thereby strike vehicle occupants. In addition, cup holders, open stowage spaces and mobile phone brackets may not always be able to hold the objects placed in them in the event of an accident. There is a risk of injury, particularly in the event of sharp braking or sudden changes of direction.

- Always stow objects in such a way that they cannot be tossed about in these or similar situations.
- Always make sure that objects do not protrude out of the stowage spaces, luggage nets or stowage nets.
- Ensure that closable stowage spaces are shut before beginning your journey.
- Always stow and secure heavy, hard, pointed, sharp-edged, fragile or large objects in the cargo compartment.

**!** Only use the cup holders for containers of the right size and which have lids. The drinks could otherwise spill.

Observe the loading guidelines (▷ page 209).

#### Cup holder on the center console

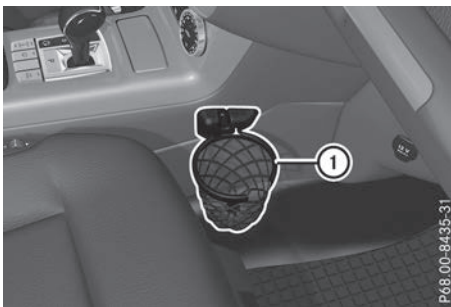

► Fold cup holder ① all the way up.

#### Cup holders in the rear compartment

**!** Ensure that you remove all containers from the cup holder in the rear before folding the seat backrest and the seat cushion of the rear bench seat forwards.

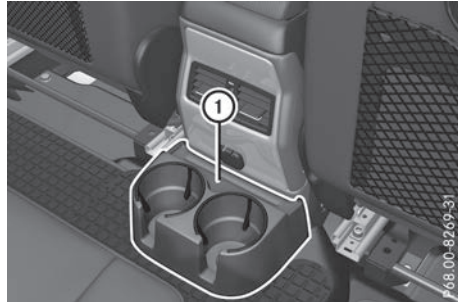

① Cup holder

#### Sun visors

#### Overview

##### WARNING

If the mirror cover of the vanity mirror is folded up when the vehicle is in motion, you could be blinded by incident light. There is a risk of an accident.

Always keep the mirror cover folded down while driving.

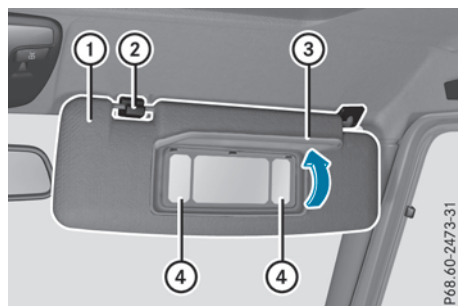

- ① Sun visor
- ② Retainer
- ③ Mirror cover
- ④ Mirror light

### Vanity mirror in the sun visor

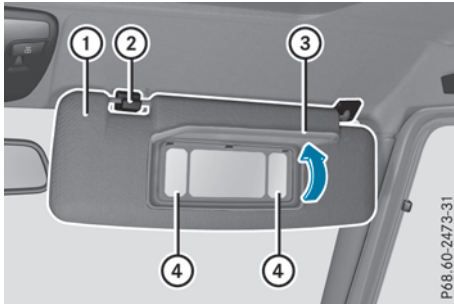

- ① Sun visor
- ② Retainer
- ③ Mirror cover
- ④ Mirror light

Mirror lights ④ will only function if sun visor ① is clipped into bracket ②.

- ▶ Fold down sun visor ①.
  - ▶ Fold up mirror cover ③.
- Mirror lights ④ are switched on automatically.

### Glare from the side

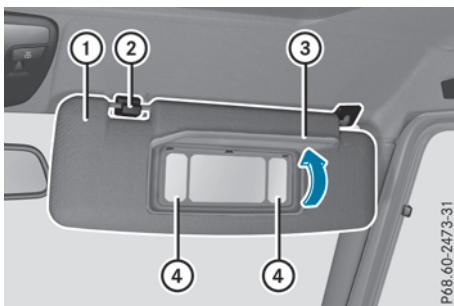

- ① Sun visor
- ② Retainer
- ③ Mirror cover
- ④ Mirror light

- ▶ Fold down sun visor ①.
- ▶ Pull sun visor ① from bracket ②.
- ▶ Swing sun visor ① to the side.

### Stowage compartment/ashtray

#### Stowage compartment/ashtray in the center console

#### ⚠ WARNING

If you engage transmission position **D** when removing the ashtray insert, the vehicle can roll away. There is a risk of an accident.

Always switch off the engine first and safeguard the vehicle against rolling away by applying the parking brake.

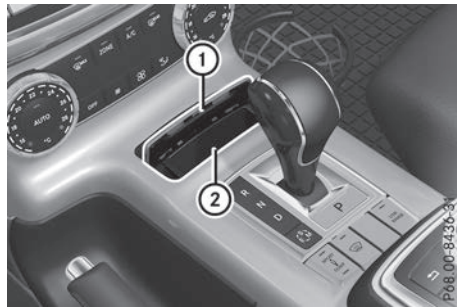

- ① Cover
- ② Insert

On new vehicles, insert ② is stored in the glove box. Install the insert before using the ashtray.

- ▶ **To open:** press cover ① and then release it. The ashtray opens.
- ▶ **To remove the insert:** make sure that the engine is switched off and that the parking brake has been applied to secure the vehicle against rolling away.
- ▶ Move the selector lever to **N**.
- ▶ Press down cover ①. Insert ② is released.
- ▶ Pull insert ② up and remove it.
- ▶ **To install the insert:** install insert ② from above.
- ▶ Push insert ② down. Insert ② audibly engages.
- ▶ **To close:** close cover ① fully.

The ashtray is lit up if the low-beam headlamps are on.

### Ashtray in the rear compartment

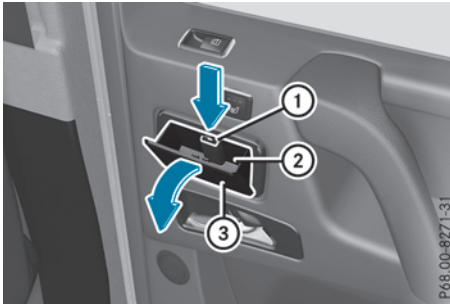

- ▶ **To open:** fold cover ③ out in the direction of the arrow.
- ▶ **To remove the insert:** press retaining lug ① and pull insert ② upwards and out.
- ▶ **To install the insert:** install insert ② from above.
- ▶ **To close:** fold down cover ③ completely.

### Cigarette lighter

#### **WARNING**

You can burn yourself if you touch the hot heating element or the socket of the cigarette lighter.

In addition, flammable materials can ignite if:

- the hot cigarette lighter falls
- a child holds the hot cigarette lighter to objects, for example

There is a risk of fire and injury.

Always hold the cigarette lighter by the knob. Always make sure that the cigarette lighter is out of reach of children. Never leave children unsupervised in the vehicle.

- ❗ The 12 V socket in the cigarette lighter can be used for accessories (up to a maximum of 180 W), as long as they have the standard socket type for cigarette lighters.

Note that the socket in the cigarette lighter can be damaged when connecting accessories, for example by:

- frequent insertion and removal
- sockets that do not fit correctly

A damaged socket can cause the cigarette lighter to stop working.



- ▶ Press in cigarette lighter ①. Cigarette lighter ① will pop out automatically when the heating element is red-hot.

### 12 V sockets

#### General notes

- ❗ If you are simultaneously using all three sockets in the vehicle, make sure that you do not exceed the maximum current draw of 45 A. Otherwise, you will overload the fuses.

The sockets can be used for accessories with a maximum current draw of 180 W (15 A) each, e.g. chargers for mobile phones.

If you use the sockets for long periods when the engine is switched off, the battery may discharge.

- ▶ Turn the SmartKey to position ② in the ignition lock.

### Socket in the front-passenger footwell



- ▶ Lift up the cover of the socket.

The cigarette lighter socket can be also used (> page 217). This is the case even if the Smart-Key has been removed from the ignition lock.

### Socket in the rear compartment

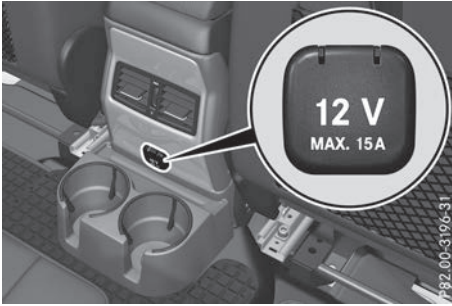

- ▶ Lift up the cover of the socket.

### Socket in the cargo compartment

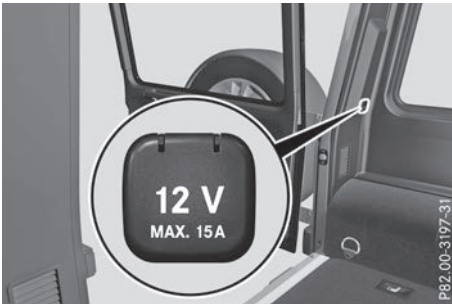

The socket is located in the cargo compartment on the left-hand side, when viewed in the direction of travel, next to the rear door.

- ▶ Lift up the cover of the socket.

### 115 V socket

#### Important safety notes

##### DANGER

When a suitable device is connected, the 115 V power socket will be carrying a high voltage. You could receive an electric shock if the connector cable or the 115 V power socket is pulled out of the trim or is damaged or wet. There is a risk of fatal injury.

- Use only connector cables that are dry and free of damage.
- When the ignition is off, make sure that the 115 V power socket is dry.
- Have the 115 V power socket checked or replaced immediately at a qualified specialized workshop if it is damaged or has been pulled out of the trim.
- Never plug the connector cable into a 115 V power socket that is damaged or has been pulled out of the trim.

##### DANGER

If you reach into the power socket or plug inappropriate devices into the power socket, you could receive an electric shock. There is a risk of fatal injury.

Only connect appropriate devices to the power socket.

- ⚠ Note that work and repairs on the 115 V power socket should only be carried out by qualified specialist personnel.

#### General notes

The 115 V power socket provides an alternating voltage of 115 V so that small electronic devices can be connected. These devices, such as games consoles, chargers and laptops, must not consume more than a maximum of 150 watts altogether.

Requirements for operation of these devices:

- the electronic device that you connect has a suitable connector and conforms to standards specific to the country you are in.
- the plug of the electronic device is plugged correctly into 115 V power socket.
- the maximum wattage of the device to be connected must not exceed 150 watts.
- the on-board power supply is within a permissible voltage range.
- the 12 V sockets in the rear compartment and the cargo compartment are operational.

### Using the 115 V power socket

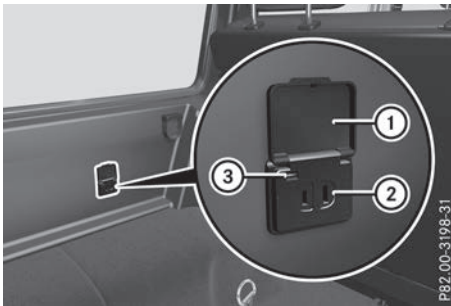

- ▶ **To switch on:** switch the ignition on.
- ▶ Open flap ①.
- ▶ Insert the plug of the electronic device into 115 V power socket ②. Indicator lamp ③ lights up.
- ▶ **To switch off:** disconnect the plug from 115 V power socket ②. Ensure that you do not pull on the cord.

### Problems with the 115 V power socket

Problem	Possible causes/consequences and ► Solutions
The warning lamp on the 115 V power socket is not lit.	<p>The on-board voltage is too low because the battery is too weak.</p> <ul style="list-style-type: none"> <li>▶ Start the engine.</li> </ul> <p>or</p> <ul style="list-style-type: none"> <li>▶ Charge the battery (► page 248).</li> </ul> <p>If the indicator lamp still does not light up:</p> <ul style="list-style-type: none"> <li>▶ Visit a qualified specialist workshop.</li> </ul>
	<p>The temperature of the DC/AC converter is temporarily too high.</p> <ul style="list-style-type: none"> <li>▶ Remove the electronic device connector from the 115 V socket.</li> <li>▶ Let the DC/AC converter cool down.</li> </ul> <p>If the indicator lamp still does not light up after cooling down the converter:</p> <ul style="list-style-type: none"> <li>▶ Visit a qualified specialist workshop.</li> </ul>
	<p>You have connected an electronic device that has a constant nominal power of less than 150 watts, but has a very high switch-on current. This device will not work. If you connect such a device, the 115 V power socket will not supply it with power.</p> <ul style="list-style-type: none"> <li>▶ Connect a suitable electronic device.</li> </ul>

### mbrace

#### General notes

The mbrace system is only available in the USA. You must have a license agreement to activate the mbrace service. Make sure that your system is activated and operational. To register, press the  Info call button. If any of the steps mentioned are not carried out, the system may not be activated.

If you have questions about the activation, contact one of the following telephone hotlines: Mercedes-Benz Customer Assistance Center at 1-800-FOR-MERCEDES (1-800-367-6372) or 1-866-990-9007

Shortly after successfully registering with the mbrace service, a user ID and password will be sent to you by mail. You can use this password to log onto the mbrace area under "Owners Online" at <http://www.mbusa.com>.

The system is available if:

- it has been activated and is operational
- the corresponding mobile phone network is available for transmitting data to the Customer Center
- a service subscription is available

Determining the location of the vehicle on a map is only possible if:

- GPS reception is available
- the vehicle position can be forwarded to the Customer Assistance Center

### The mbrace system

To adjust the volume during a call, proceed as follows:

- ▶ Press the  or  button on the multifunction steering wheel.

or

- ▶ Use the multimedia system volume control.

The system offers various services, e.g.:



- Automatic and manual emergency call
- Roadside Assistance call
- Info call

You can find information and a description of all available features under "Owners Online" at <http://www.mbusa.com>.

### System self-test

After you have switched on the ignition, the system carries out a self-diagnosis.

A malfunction in the system has been detected if one of the following occurs:

- The indicator lamp in the SOS button does not come on during the system self-test.
- The indicator lamp in the  Roadside Assistance button does not light up during self-diagnosis of the system.
- The indicator lamp in the  Info call button does not light up during the system self-diagnosis

- The indicator lamp in one or more of the following buttons continues to light up red after the system self-diagnosis:

- SOS button
-  Roadside Assistance call button
- Info call button 

- After the system self-diagnosis, the **Inoperative** or **Service Not Activated** message appears in the multifunction display.

If a malfunction is indicated as outlined above, the system may not operate as expected. In the event of an emergency, help will have to be summoned by other means.

Have the system checked at the nearest Mercedes-Benz Service Center or contact the following service hotlines:

Mercedes-Benz Customer Assistance Center at 1-800-FOR-MERcedes (1-800-367-6372) or 1-866-990-9007

### Emergency call

#### Important safety notes

##### **WARNING**

It can be dangerous to remain in the vehicle, even if you have pressed the SOS button in an emergency if:

- you see smoke inside or outside of the vehicle, e.g. if there is a fire after an accident
- the vehicle is on a dangerous section of road
- the vehicle is not visible or cannot easily be seen by other road users, particularly when dark or in poor visibility conditions

There is a risk of an accident and injury.

Leave the vehicle immediately in this or similar situations as soon as it is safe to do so.

Move to a safe location along with other vehicle occupants. In such situations, secure the vehicle in accordance with national regulations, e.g. with a warning triangle.

#### General notes

Observe the notes on system activation (> page 219).

An emergency call is dialed automatically if an air bag or Emergency Tensioning Device is trig-

gered. You cannot end an automatically triggered emergency call yourself.

An emergency call can also be initiated manually.

As soon as the emergency call has been initiated, the indicator lamp in the SOS button flashes. The **Connecting Call** message appears in the multifunction display.

The audio output is muted.

Once the connection has been made, the **Call Connected** message appears in the multifunction display.

All important information on the emergency is transmitted, for example:

- Current location of the vehicle (as determined by the GPS system)
- Vehicle identification number
- Information on the severity of the accident

Shortly after the emergency call has been initiated, a voice connection is automatically established between the Customer Assistance Center and the vehicle occupants.

- If the vehicle occupants respond, the Mercedes-Benz Customer Assistance Center attempts to get more information on the emergency.
- If there is no response from the vehicle occupants, an ambulance is immediately sent to the vehicle.

If no voice connection can be established to the Mercedes-Benz Customer Assistance Center, the system has been unable to initiate an emergency call.

This can occur, for example, if the relevant mobile phone network is not available. The indicator lamp in the SOS button flashes continuously.

The **Call Failed** message appears in the multifunction display and must be confirmed.

In this case, summon assistance by other means.

## Making an emergency call



- ▶ **To initiate an emergency call manually:** press cover ① briefly to open.
- ▶ Press and hold the SOS button for at least one second ②. The indicator lamp in SOS button ② flashes until the emergency call is concluded.
- ▶ Wait for a voice connection to the Mercedes-Benz Customer Assistance Center.
- ▶ After the emergency call, close cover ①.

If the mobile phone network is unavailable, mbrace will not be able to make the emergency call. If you leave the vehicle immediately after pressing SOS button ②, you do not know if mbrace has successfully made the emergency call. In this case, always summon assistance by other means.

## Breakdown assistance button



- ▶ **To call:** press Roadside Assistance button ①. This initiates a call to the Mercedes-Benz Customer Assistance Center. The indicator lamp in Roadside Assistance button ① flashes while the call is active. The **Connecting Call** message appears in the

multifunction display. The audio output is muted.

If a connection can be made, the **Call Connected** message appears in the multifunction display.

If a mobile phone network and GPS reception are available, the system transfers data to the Mercedes-Benz Customer Assistance Center, for example:

- Current location of the vehicle
- Vehicle identification number

The multimedia system display indicates that a call is active. During the call, you can change to the navigation menu by pressing the NAVI button on the multimedia system, for example.

Voice output is not available in this case.

A voice connection is established between the Mercedes-Benz Customer Assistance Center and the vehicle occupants.

From the remote malfunction diagnosis, the Mercedes-Benz Customer Assistance Center can ascertain the nature of the problem (> page 225).

The Mercedes-Benz Customer Assistance Center either sends a qualified Mercedes-Benz technician or makes arrangements for your vehicle to be transported to the nearest Mercedes-Benz Service Center.

You may be charged for services such as repair work and/or towing.

You can find more information in the separate mbrace manual.

The system has not been able to initiate a Roadside Assistance call, if:

- the  indicator lamp for the Roadside Assistance call button is flashing continuously.
- no voice connection to the Mercedes-Benz Customer Assistance Center was established.

This can occur if the relevant mobile phone network is not available, for example.

The **Call Failed** message appears in the multifunction display.

► **To end a call:** press the  button on the multifunction steering wheel.

or

► Press the corresponding multimedia system button for ending a phone call.

## Info call button



► **To call:** press Info call button ①.

This initiates a call to the Mercedes-Benz Customer Assistance Center.

The indicator lamp in Info call button ① flashes while the connection is being made. The **Connecting Call** message appears in the multifunction display. The audio output is muted.

If a connection can be made, the **Call Connected** message appears in the multifunction display.

If a mobile phone network and GPS reception are available, the system transfers data to the Mercedes-Benz Customer Assistance Center, for example:

- Current location of the vehicle
- Vehicle identification number

The multimedia system display indicates that a call is active. During the call, you can change to the navigation menu by pressing the NAVI button on COMAND, for example.

Voice output is not available in this case.

A voice connection is established between the Mercedes-Benz Customer Assistance Center and the vehicle occupants.

You receive information about operating your vehicle, about the nearest Mercedes-Benz Service Center and about other products and services from Mercedes-Benz.

You can find further information on the mbrace system under "Owners Online" at <http://www.mbusa.com>.



The system has not been able to initiate an MB Info call, if:

- the indicator lamp in the  Info call button is flashing continuously.
- no voice connection to the Mercedes-Benz Customer Assistance Center was established.

This can occur if the relevant mobile phone network is not available, for example.

The **Call Failed** message appears in the multifunction display.

▶ **To end a call:** press the  button on the multifunction steering wheel.

or

▶ Press the corresponding multimedia system button for ending a phone call.

### Call priority

When service calls are active, e.g. Roadside Assistance or Info calls, an emergency call can still be initiated. In this case, an emergency call will take priority and override all other active calls.

The indicator lamp of the respective button flashes until the call is ended.

An emergency call can only be terminated by the Mercedes-Benz Customer Assistance Center.

All other calls can be ended by pressing:

- the  button on the multifunction steering wheel
- the corresponding button in the multimedia system to end the voice call

When a call is initiated, the audio system is muted.

The mobile phone is no longer connected to the multimedia system.

However, if you want to use your mobile phone, do so only when the vehicle is stationary and in a safe location.

### Downloading destinations



#### Downloading destinations

Downloading destinations gives you access to a database with over 15 million points of interest (POIs). These can be downloaded on the navigation system in your vehicle. If you know the destination, the address can be downloaded. Alternatively, you can obtain the location of

Points of Interest (POIs)/important destinations in the vicinity.

Furthermore, you can download routes with up to four way points.

You are prompted to confirm route guidance to the address entered.

▶ Select **Yes** by turning  or sliding  the controller and confirm with .

The system calculates the route and subsequently starts the route guidance with the address entered.

If you select **No** the address can be stored in the address book.

The destination download function is available if:

- the vehicle is equipped with a navigation system.
- the relevant mobile phone network is available and data transfer is possible.

### Route Assistance

This service is part of the mbrace PLUS Package and cannot be purchased separately.

You can use the Route Assistance function even if the vehicle is not equipped with a navigation system.

Within the framework of this service, you receive a professional and reliable form of navigation support without having to leave your vehicle.

The customer service representative finds a suitable route depending on your vehicle's current position and the desired destination. You will then be guided live through the current route section.

### Search and Send

#### General notes

To use "Search & Send", your vehicle must be equipped with mbrace and a navigation system. Additionally, an mbrace service subscription must be completed.

"Search & Send" is a destination entry service. A destination address which is found on Google Maps® can be transferred via mbrace directly to your vehicle's navigation system.

### Specifying and sending the destination address

- ▶ Go to the website <http://maps.google.com> and enter a destination address into the entry field.

- ▶ **To send the destination address to the e-mail address of your mbrace account:** click on the corresponding button on the website.

Example:

If you select 'Send to vehicle' and then 'Mercedes-Benz', the destination address will be sent to your vehicle.

- ▶ When the "Send" dialog window appears: Enter the e-mail address you specified when setting up your mbrace account into the corresponding field.
- ▶ Click "Send".



Information on specific commands such as "Address entry" or "Send" can be found on the website.

### Calling up a transmitted destination address

- ▶ Turn the SmartKey to position **2** in the ignition lock (> page 105).

The transmitted destination address is loaded into the vehicle's navigation system.

A display message appears, asking whether navigation should be started.

- ▶ Select **Yes** by turning  or sliding  the controller and confirm with .

The system calculates the route and subsequently starts the route guidance with the address entered.

If you select **No** the address can be stored in the address book.

If you have sent more than one destination address, each individual destination must be confirmed separately.

Destination addresses are loaded in the same order as the order in which they were sent.

If you own multiple Mercedes-Benz vehicles with mbrace and activated mbrace accounts:

If multiple vehicles are registered under the same e-mail address, the destination will be sent to all the vehicles.

### Vehicle remote opening

You can use the vehicle remote opening if you have unintentionally locked your vehicle and a replacement SmartKey is not available.

The vehicle can be opened by the Mercedes-Benz Customer Assistance Center.

The vehicle can be immediately opened remotely within four days of the ignition being turned off. After this time, the remote unlocking may be delayed by 15 to 60 minutes. After 30 days, the vehicle can no longer be opened remotely.

The vehicle remote unlocking feature is available if the relevant mobile phone network is available and a data connection is possible.

- ▶ Contact the following service hotlines:  
Mercedes-Benz Customer Assistance Center at 1-800-FOR-MERcedes (1-800-367-6372) or 1-866-990-9007  
You will be asked for your password.
- ▶ Return to your vehicle at the time agreed upon with the Mercedes-Benz Customer Assistance Center.

Alternatively, the vehicle can be opened via:

- the Internet, under the "Owners Online" section
- telephone applications (e.g. for iPhone®, Android™)

To do this, you will need your identification number and password.

### Vehicle remote closing

The vehicle remote closing feature can be used when you have forgotten to lock the vehicle and you are no longer nearby.

The vehicle can then be locked by the Mercedes-Benz Customer Assistance Center.

The vehicle can be immediately remotely locked within four days of the ignition being turned off. After this time, remote closing may be delayed by 15 to 60 minutes. After 30 days the vehicle can no longer be locked remotely.

The vehicle remote closing feature is available if the relevant mobile phone network is available and a data connection is possible.

- ▶ Contact the following service hotlines:

Mercedes-Benz Customer Assistance Center at 1-800-FOR-MERCEdes (1-800-367-6372) or 1-866-990-9007

You will be asked for your password.

The next time you are inside the vehicle and you switch on the ignition, the **Doors Locked Remotely** message appears in the multifunction display.

Alternatively, the vehicle can be locked via:

- the Internet, under the "Owners Online" section
- telephone applications (e.g. for iPhone®, Android™)

To do this, you will need your identification number and password.

### Stolen vehicle recovery service

If your vehicle has been stolen:

- ▶ Notify the police.  
The police will issue a numbered incident report.
- ▶ This number will be forwarded to the Mercedes-Benz Customer Assistance Center together with your PIN.  
The Mercedes-Benz Customer Assistance Center then tries to locate the system. The Mercedes-Benz Customer Assistance Center contacts you and the local law enforcement agency if the vehicle is located.  
However, only the law enforcement agency is informed of the location of the vehicle.

If the anti-theft alarm system is activated for longer than 30 seconds, the Mercedes-Benz Customer Assistance Center is automatically notified.

### Vehicle Health Check

With the Vehicle Health Check, the Customer Assistance Center can provide improved support for problems with your vehicle. During an existing call, vehicle data is transferred to the Customer Assistance Center.

The customer service representative can use the received data to decide what kind of assistance is required. You are then, for example, guided to the nearest Mercedes-Benz Service Center or a recovery vehicle is called.

If vehicle data need to be transferred during an Info call or a Roadside Assistance call, this is initiated by the Customer Assistance Center.

You will see the **Roadside Assistance Connected** message in the display. If the Vehicle Health Check can be started, the **Request for Vehicle Diagnostics Received Start vehicle diagnostics?** message appears in the display.

- ▶ Press the **Yes** button to confirm the message.
- ▶ If the **Vehicle Diagnostics Please Start Ignition** message appears: turn the SmartKey to position **2** in the ignition lock (▷ page 105).
- ▶ If the **Please follow the instructions received by phone and move your vehicle to a safe position.** message appears: please follow the instructions received by phone and move your vehicle to a safe position.  
The message in the display disappears.  
The vehicle operating state check begins. You will see the **Vehicle Diagnostics Active** message.  
If you select **Cancel**, the Vehicle Health Check is canceled completely.

When the check is complete, the **Sending vehicle diagnostics data. (Voice connection may be interrupted during data transfer)** message appears. The vehicle data can now be sent.

- ▶ Press the **OK** button to confirm the message.  
The voice connection with the Customer Assistance Center is terminated.  
You will see the **Vehicle Diagnostics: Transferring Data...** message.  
The vehicle data is sent to the Customer Assistance Center.

Depending on what the customer service representative agreed with you, the voice connection is re-established after the transfer is complete. If necessary, you will be contacted at a later time by another means, e.g. by e-mail or phone.

Another function of the Vehicle Health Check is the transfer of service data to the Customer Assistance Center. If a service is due, the display shows a message to this effect together with information about any special offers at your workshop.

This information can also be called up under "Owners Online" at <http://www.mbusa.com>. Information on the data stored in the vehicle (▷ page 28).

Information on Roadside Assistance  
(▷ page 25).

### Downloading routes

Downloading routes allows you to transfer and save predefined routes in the navigation system.

A route can be prepared and sent by either a customer service representative or under "Owners Online" at <http://www.mbusa.com>.

Each route can include up to four way points.

Once a route has been received by the navigation system, you will see the **Do you want to start route guidance? Destination Received destination has been saved in "Previous destinations"**. message on the multimedia system display.

The route is saved.

► **To start route guidance:** select **Yes**.

An overview of the route is shown in the display.

If you select **No**, the saved route can be called up later in the navigation menu.

► Select **Start**.

Route guidance starts.

Downloaded and saved routes can be called up again.

### Speed alert

You can define the upper speed limit, which must not be exceeded by the vehicle.

If this selected speed is exceeded by the vehicle, a message will be sent to the Customer Assistance Center. The Customer Assistance Center then forwards this information to you.

You can select the way in which you receive this information beforehand. Possible options include text message, e-mail or an automated call.

The data you receive contains the following information:

- the location where the speed limit was exceeded
- the time at which the speed limit was exceeded
- the selected speed limit which was exceeded

### Geo fencing

Geo fencing allows you to select areas which the vehicle should not enter or leave. You will be informed if the vehicle crosses the boundaries of the selected areas. You can select the way in which you receive this information beforehand. Possible options include text message, e-mail or an automated call.

The area can be determined as either a circle or a polygon with a maximum of ten corners. You can specify up to ten areas simultaneously. Different settings are possible for each area.

These settings can be called up under "Owners Online" at <http://www.mbusa.com>.

Alternatively, you can trigger an Info call and notify the customer service representative that you wish to activate geo-fencing.

Currently inactive areas can be activated by text message.

### Triggering the vehicle alarm

With this function, you can trigger the vehicle's panic alarm via text message. An alarm sounds and the exterior lighting flashes. Depending on the setting, the panic alarm lasts five or ten seconds. Afterwards, the alarm switches off.

### Brush guard (USA only)

If the brush guard has to be removed, contact a qualified specialist workshop.

### Garage door opener

#### General notes

You can use the HomeLink® garage door opener integrated into the rear-view mirror to operate up to three different gate/garage door opener systems.

Certain garage door drives are incompatible with the integrated garage door opener. If you have difficulty programming the integrated garage door opener, contact a Mercedes-Benz Service Center.

Alternatively, you can call the following telephone assistance services:

- **USA:** Mercedes-Benz Customer Assistance Center at 1-800-FOR-MERCEdes
- **Canada:** Customer Service at 1-800-387-0100
- HomeLink® hotline 1-800-355-3515 (free of charge)

More information on HomeLink® and/or compatible products is also available online at <http://www.homelink.com>.

Notes on the declaration of conformity (▷ page 26).

USA: FCC ID: CB2HMIHL4

Canada: IC: 279B-HMIHL4

USA only:

This device complies with Part 15 of the FCC Rules. Operation is subject to the following two conditions:

1. This device may not cause harmful interference, and
2. this device must accept any interference received, including interference that may cause undesired operation.

Any unauthorized modification to this device could void the user's authority to operate the equipment.

Canada only:

This device complies with RSS-210 of Industry Canada. Operation is subject to the following two conditions:

1. This device may not cause harmful interference, and
2. this device must accept any interference received, including interference that may cause undesired operation.

Any unauthorized modification to this device could void the user's authority to operate the equipment.

### Important safety notes

#### WARNING

When you operate or program the garage door with the integrated garage door opener, persons in the range of movement of the garage door can become trapped or struck by the garage door. There is a risk of injury.

When using the integrated garage door opener, always make sure that nobody is within the range of movement of the garage door.

#### WARNING

Combustion engines emit poisonous exhaust gases such as carbon monoxide. Inhaling these exhaust gases leads to poisoning. There is a risk of fatal injury. Therefore never leave the engine running in enclosed spaces without sufficient ventilation.

Only operate the following garage doors using the garage door opener:

- garage doors with a safety stop and reversing function
- garage doors which conform to the current U.S. safety standards

When programming a garage door opener, park the vehicle outside the garage. Do not run the engine while programming.

### Programming

#### Programming

Pay attention to the "Important safety notes" (▷ page 227).

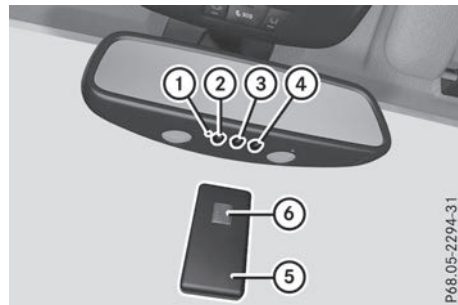

Garage door remote control (5) is not included with the integrated garage door opener.

- ▶ Delete the memory of the integrated remote control (▷ page 229) before programming it for the first time.
- ▶ Turn the SmartKey to position (2) in the ignition lock (▷ page 105).
- ▶ Select one of buttons (2) to (4) to use to control the garage door drive.

- ▶ **To start programming mode:** press and hold one of buttons ② to ④ on the integrated garage door opener.

The garage door opener is now in programming mode. After a short time, indicator lamp ① will start flashing. It flashes approximately once per second.

Indicator lamp ① flashes immediately the first time that the transmitter button is programmed. If this transmitter button has already been programmed, indicator lamp ① will only start flashing at a rate of once a second after 20 seconds have elapsed.

- ▶ Continue to hold the transmitter button.
- ▶ **To program the remote control:** point transmitter button ⑥ of remote control ⑤ towards the transmitter buttons on the rear-view mirror at a distance of 2 to 12 in (5 to 30 cm).
- ▶ Keep transmitter button ⑥ on remote control ⑤ pressed until indicator lamp ① starts to flash rapidly.  
When indicator lamp ① flashes rapidly: programming is finished.
- ▶ Release transmitter buttons ②, ③ or ④ on the integrated remote control and transmitter button ⑥ on remote control ⑤.  
If indicator lamp ① does not flash rapidly and goes out after approximately 20 seconds: repeat the programming process for the corresponding button on the rear-view mirror. When doing so, vary the distance between remote control ⑤ and the rear-view mirror.  
The required distance between remote control ⑤ and the integrated garage door opener depends on the garage door drive system. Several attempts might be necessary. You should test every position for at least 20 seconds before trying another position.

If the garage door system works with a rolling code, you must synchronize the remote control integrated in the rear-view mirror with the garage door system receiver after programming.

You can find further information on this in the operating instructions of the garage door system.

### Synchronizing the rolling code

Pay attention to the "Important safety notes" (▷ page 227).

If the garage door system uses a rolling code, you will also have to synchronize the garage

door system with the integrated garage door opener in the rear-view mirror. To do this you will need to use the programming button on the door drive control panel. The programming button may be located in different places depending on the manufacturer. It is usually located on the door drive unit on the garage ceiling.

Familiarize yourself with the garage door drive operating instructions, e.g. under "Programming additional remote controls", before carrying out the following steps.

Your vehicle must be within reach of the garage door or gate opener drive. Make sure that neither your vehicle nor any persons/objects are present within the sweep of the door or gate. Observe the safety notes when performing the rolling code synchronization (▷ page 227).

- ▶ Turn the SmartKey to position ② in the ignition lock (▷ page 105).
- ▶ Get out of the vehicle.
- ▶ Press the programming button on the door drive unit.  
You now have 30 seconds to initiate the next step.
- ▶ Get into the vehicle.
- ▶ Press previously programmed button ②, ③ or ④ on the integrated garage door opener repeatedly until the door closes.  
The rolling code synchronization is then complete.

### Notes on programming the remote control

Canadian radio frequency laws require a "break" (or interruption) of the transmission signals after broadcasting for a few seconds. Therefore, these signals may not last long enough for the integrated remote control to recognize the signal during programming. Comparable with Canadian law, American garage door openers also have a built-in "interruption".

Proceed as follows:

- if you live in Canada.
- if you have difficulties programming the garage door opener (regardless of where you live) when following the programming steps.
- ▶ Press and hold one of buttons ② to ④ on the integrated garage door opener until the integrated remote control is successfully set up.
- ▶ Simultaneously press transmitter button ⑥ on remote control ⑤ and hold for two sec-

onds. Then let go for 2 seconds, press again and hold for 2 seconds.

- ▶ Repeat this sequence on transmitter button ⑥ on remote control ⑤ until the frequency signal is established.
- ▶ If the setup procedure is successful, indicator lamp ① flashes once slowly and goes out after a few seconds.  
If indicator lamp ① does not flash slowly and then go out: repeat the programming process for the corresponding button on the rear-view mirror. When doing so, vary the distance between remote control ⑤ and the rear-view mirror.

The required distance between remote control ⑤ and the integrated garage door opener depends on the garage door drive system. Several attempts might be necessary. You should test every position for at least 20 seconds before trying another position.

The required distance between remote control ⑤ and the integrated garage door opener depends on the garage door drive system. Several attempts might be necessary. You should test every position for at least 25 seconds before trying another position.

### Problems when programming

If you have problems when programming the integrated remote control, please note the following:

- Check the transmitter frequency used by garage door drive remote control ⑤ and whether it is supported. The transmitter frequency can usually be found on the back of remote control ⑤ for the garage door drive. The integrated remote control is compatible with devices that have units which operate in the frequency range of 280 to 390 MHz.
- Replace the batteries in remote control ⑤. This increases the probability of remote control ⑤ sending a strong and precise signal to the integrated remote control on the rear-view mirror.
- When programming, hold remote control ⑤ at varying distances and angles from the transmitter button that you are programming. Try various angles at a distance between 2 and 12 inches (5 to 30 cm) or at the same angle but at varying distances.
- If a further remote control ⑤ is available for the same garage door drive, repeat the same programming steps with this remote control

⑤. Before performing these steps, make sure that new batteries have been installed in garage door drive remote control ⑤.

- Note that some remote controls only transmit for a limited amount of time (the indicator lamp on the remote control goes out). Press button ⑥ on remote control ⑤ again before transmission ends.
- Align the antenna cable of the garage door opener unit. This can improve signal transmission.

### Opening/closing the garage door

Once programmed, the integrated remote control will assume the function of the garage door system's remote control. Please also read the operating instructions for the garage door system.

- ▶ Turn the SmartKey to position in the ignition lock ② (▷ page 105).
- ▶ Press one of buttons ② to ④ on the integrated remote control in the rear-view mirror that is programmed to operate the garage door. Garage door system with fixed code: indicator lamp ① lights up continuously.

Garage door system with rolling code: indicator lamp ① flashes briefly and then lights up for approximately two seconds. This is repeated for up to 20 seconds.

The transmitter will transmit a signal for as long as the transmitter button is being pressed. The transmission will be halted after a maximum of 20 seconds and indicator lamp ① will flash. Press the transmitter button again if necessary.

- ▶ Press button ②, ③ or ④ again if necessary.

### Clearing the memory

Make sure that you clear the memory of the integrated garage door opener before selling the vehicle.

- ▶ Turn the SmartKey to position ② (▷ page 105) in the ignition lock.
- ▶ Press and hold transmitter buttons ② and ④ for approximately 20 seconds until indicator lamp ① flashes rapidly. The memory of the integrated garage door opener in the rear-view mirror is cleared.

## Engine compartment

### Hood

#### Important safety notes

##### WARNING

If the hood is unlatched, it may open up when the vehicle is in motion and block your view. There is a risk of an accident.

Never unlatch the hood while driving. Before every trip, ensure that the hood is locked.

##### WARNING

When opening and closing the hood, it may suddenly fall into the closed position. There is a risk of injury to persons within range of movement of the hood.

Open and close the hood only when no one is within its range of movement.

##### WARNING

Opening the hood when the engine is overheated or when there is a fire in the engine compartment could expose you to hot gases or other service products. There is a risk of injury.

Let an overheated engine cool down before opening the hood. If there is a fire in the engine compartment, keep the hood closed and contact the fire department.

##### WARNING

The ignition system and the fuel injection system work under high voltage. If you touch components which are under voltage, you could get an electric shock. There is a risk of injury.

Never touch components of the ignition system or fuel injection system when the ignition is switched on.

##### WARNING

The engine compartment contains moving components. Certain components, such as the radiator fan, may continue to run or start

again suddenly when the ignition is off. There is a risk of injury.

If you need to do any work inside the engine compartment:

- switch off the ignition
- never reach into the area where there is a risk of danger from moving components, such as the fan rotation area
- remove jewelry and watches
- keep items of clothing and hair, for example, away from moving parts

Do not touch the following when the ignition is switched on:

- ignition coils
- spark plug connectors
- test socket

#### Opening the hood

##### WARNING

Certain components in the engine compartment, such as the engine, radiator and parts of the exhaust system, can become very hot. Working in the engine compartment poses a risk of injury.

Where possible, let the engine cool down and touch only the components described in the following.

##### WARNING

When the hood is open and the windshield wipers are set in motion, you can be injured by the wiper linkage. There is a risk of injury.

Always switch off the windshield wipers and the ignition before opening the hood.

- ❗ Make sure that the windshield wipers are not folded away from the windshield. You could otherwise damage the windshield wipers or the hood.





The hood release lever is located in the footwell on the left-hand side of the vehicle when viewed in the direction of travel.

- ▶ Make sure that the windshield wipers are turned off.
- ▶ Pull release lever ① on the hood. The hood is released.

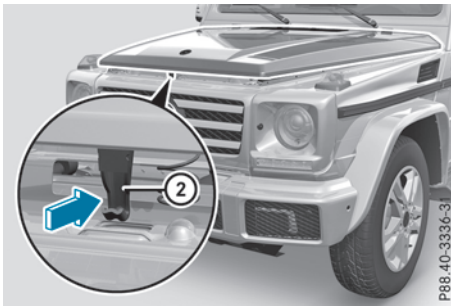

- ▶ Lift the hood slightly.
- ▶ Push the handle of hood catch ② in the direction of the arrow and lift the hood. The hood is opened and held open automatically by the gas-filled strut.

### Closing the hood

- ▶ Lower the hood and let it fall from a height of approximately 8 in (20 cm).
- ▶ Check that the hood has engaged properly. If the hood can be raised slightly, it is not properly engaged. Open it again and close it with a little more force.

### Radiator

Do not cover up the radiator, such as with a thermal mat or insect protection cover. Otherwise, the values of the European on-board diag-

nostics may be affected. Some of these readings are required by law and must be accurate at all times.

### Engine oil

#### Important safety notes

#### WARNING

Certain components in the engine compartment, such as the engine, radiator and parts of the exhaust system, can become very hot. Working in the engine compartment poses a risk of injury.

Where possible, let the engine cool down and touch only the components described in the following.

#### WARNING

The engine compartment contains moving components. Certain components, such as the radiator fan, may continue to run or start again suddenly when the ignition is off. There is a risk of injury.

If you need to do any work inside the engine compartment:

- switch off the ignition
- never reach into the area where there is a risk of danger from moving components, such as the fan rotation area
- remove jewelry and watches
- keep items of clothing and hair, for example, away from moving parts

#### WARNING

If engine oil comes into contact with hot components in the engine compartment, it may ignite. There is a risk of fire and injury.

Make sure that engine oil is not spilled next to the filler neck. Let the engine cool down and thoroughly clean the engine oil off the components before starting the engine.

**⚠ WARNING**

Opening the hood when the engine is overheated or when there is a fire in the engine compartment could expose you to hot gases or other service products. There is a risk of injury.

Let an overheated engine cool down before opening the hood. If there is a fire in the engine compartment, keep the hood closed and contact the fire department.

**Notes on the oil level**

Depending on your driving style, the vehicle consumes up to 0.9 US qt (0.8 liters) of oil per 600 miles (1000 km). The oil consumption may be higher than this when the vehicle is new or if you frequently drive at high engine speeds.

Depending on the engine, the oil dipstick may be in a different location.

When checking the oil level:

- park the vehicle on a level surface
- the engine should be switched off for approximately five minutes if the engine is at normal operating temperature
- if the engine is not at normal operating temperature, e.g. if the engine was only started briefly, wait approximately 30 minutes before carrying out the measurement

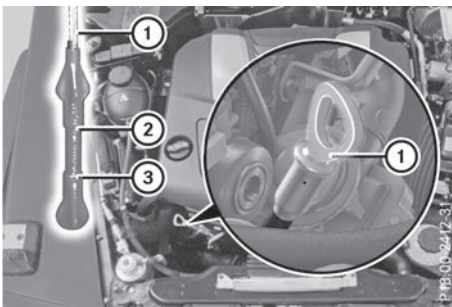
**Checking the oil level using the oil dipstick**

Example: engine compartment

On the G 63 AMG, the oil level can be checked using the oil dipstick.

- ▶ Pull oil dipstick ① out of the dipstick guide tube.
- ▶ Wipe off oil dipstick ①.
- ▶ Slowly slide oil dipstick ① into the guide tube to the stop and take it out again after approximately three seconds.  
If the level is between MIN mark ③ and MAX mark ②, the oil level is correct.
- ▶ If the oil level has dropped to MIN mark ③ or below, add 1.1 US qt (1.0 l) of engine oil.

On all other models, the on-board computer must be used to check the engine oil level.

**Checking the oil level using the on-board computer**

**G 550:** the oil level can only be checked using the on-board computer.

- ▶ Make sure that the SmartKey is in position ② in the ignition lock.
- ▶ Press **▲** or **▼** on the steering wheel to select the following message: **Measuring Engine Oil Level Accurate Only When Vehicle Is Level**

The measurement takes a few seconds. You will see one of the following messages in the multi-function display:

- **Engine Oil Level OK**
  - **Add 1.1 liters Eng. Oil at Next Refueling**
- ▶ Add oil if necessary.

If the engine is at normal operating temperature and the **Reduce Engine Oil Level** display appears, too much oil has been added.

- ▶ Have excess oil siphoned off.

If the **For Engine Oil Level Ignition Must Be On** message appears:



- ▶ Turn the SmartKey to position ② in the ignition lock (▷ page 105).

If the **Need More Time to Check Engine Oil Level** message appears:

- ▶ **If the engine is at normal operating temperature:** repeat the measurement after approximately five minutes.
- ▶ **If the engine is not at normal operating temperature:** e.g. if the engine was only started briefly, repeat the measurement after approximately 30 minutes.

If the **Engine Oil Level Not Measurable with Running Engine** message appears:

- ▶ Switch off the engine.
- ▶ **If the engine is at normal operating temperature:** wait about five minutes before carrying out the measurement.
- ▶ **If the engine is not at normal operating temperature:** e.g. if the engine was only started briefly, wait approximately 30 minutes before carrying out the measurement.

If you wish to cancel the measurement, press the  or  button on the multifunction steering wheel.

### Adding engine oil

**!** Use only engine oils and oil filters that are approved for vehicles with a service system. A list of the engine oils and oil filters that have been tested and approved in accordance with Mercedes-Benz Specifications for Service Products is available at any authorized Mercedes-Benz Center.

The following cause engine failure or damage to the exhaust system:

- Use of engine oils and oil filters that have not been expressly approved for the service system
- Replacement of engine oil and oil filter after the replacement interval specified by the service system has expired
- Use of engine oil additives

**!** Do not add too much oil. If the oil level is above the "max" mark on the dipstick, too much oil has been added. This can lead to damage to the engine or the catalytic converter. Have excess oil siphoned off.

#### Environmental note

When adding oil, take care not to spill any. If oil enters the soil or waterways, it is harmful to the environment.

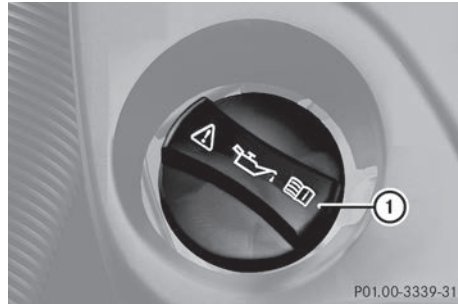

Example: engine oil cap

- ▶ Turn cap  counter-clockwise and remove it.
- ▶ Add the amount of engine oil required.

Observe the specifications in the on-board computer when doing so or fill carefully to the maximum mark on the oil dipstick.

The difference between the minimum mark and the maximum mark on the oil dipstick is approximately 2.1 US qt (2.0 l).

- ▶ Replace cap  on the filler neck and tighten clockwise.

Ensure that the cap locks into place securely.

Further information on engine oil (▶ page 285).

### Additional service products

### Important safety notes

#### WARNING

Certain components in the engine compartment, such as the engine, radiator and parts of the exhaust system, can become very hot. Working in the engine compartment poses a risk of injury.

Where possible, let the engine cool down and touch only the components described in the following.

#### WARNING

The engine compartment contains moving components. Certain components, such as the radiator fan, may continue to run or start again suddenly when the ignition is off. There is a risk of injury.

If you need to do any work inside the engine compartment:

- switch off the ignition
- never reach into the area where there is a risk of danger from moving components, such as the fan rotation area
- remove jewelry and watches
- keep items of clothing and hair, for example, away from moving parts

#### WARNING

The cooling system is pressurized, particularly when the motor is warm. If you open the cap, you could be scalded if hot coolant sprays out. There is a risk of injury.

Let the engine cool down before you open the cap. Wear gloves and eye protection. Slowly open the cap to relieve pressure.

#### WARNING

Opening the hood when the engine is overheated or when there is a fire in the engine compartment could expose you to hot gases or other service products. There is a risk of injury.

Let an overheated engine cool down before opening the hood. If there is a fire in the engine compartment, keep the hood closed and contact the fire department.

### Checking coolant level

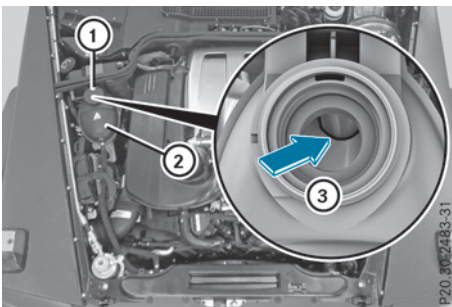

Checking the coolant level (example)

- ▶ Park the vehicle on a level surface.

Only check the coolant level when the vehicle is on a level surface and the engine has cooled down.

- ▶ Turn the SmartKey to position **2** in the ignition lock (▷ page 105).
- ▶ Check the coolant temperature display in the instrument cluster.  
The coolant temperature must be below 158 °F (70 °C).
- ▶ Slowly turn cap **1** half a turn counter-clockwise and allow excess pressure to escape.
- ▶ Turn cap **1** further counter-clockwise and remove it.

If the coolant is at the level of marker bar **3** in the filler neck when cold, there is enough coolant in coolant expansion tank **2**.

If the coolant level is approximately 0.6 in (1.5 cm) above marker bar **3** in the filler neck when warm, there is enough coolant in coolant expansion tank **2**.

- ▶ If necessary, add coolant that has been tested and approved by Mercedes-Benz.
- ▶ Replace cap **1** and turn it clockwise as far as it will go.

For further information on coolant, see (▷ page 286).

### Adding washer fluid to the windshield washer system/headlamp cleaning system

#### WARNING

Windshield washer concentrate could ignite if it comes into contact with hot engine components or the exhaust system. There is a risk of fire and injury.

Make sure that no windshield washer concentrate is spilled next to the filler neck.

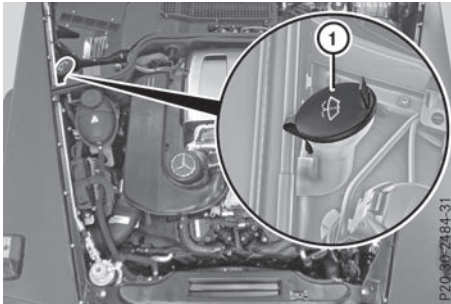

Example: adding liquid to the windshield washer system

- ▶ **To open:** pull cap ① upwards by the tab and open.
- ▶ Add the premixed washer fluid.
- ▶ **To close:** press cap ① onto the filler neck until it engages.

The washer fluid reservoir is used for both the windshield washer system and the headlamp cleaning system.

If the washer fluid level drops below the recommended minimum of 3.7 US qt (3.5 l), a message appears in the multifunction display prompting you to add washer fluid (▷ page 191).

Further information on washer fluid (▷ page 287).

### Brake fluid level

**!** If you notice that the brake fluid level in the brake fluid reservoir has fallen to the MIN mark or less, check the brake system immediately for leaks. Also check the thickness of the brake linings. Visit a qualified specialist workshop immediately.

Do not add brake fluid. This does not correct the error.

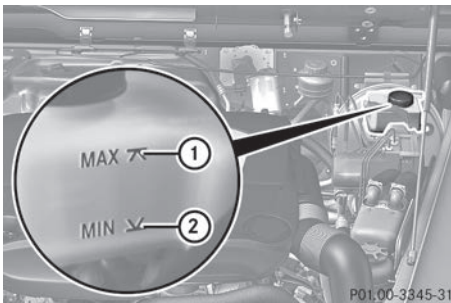

Only check the brake fluid level when the vehicle is stationary and on a level surface. The brake fluid level is correct if the level is between MAX mark ① and MIN mark ② on the brake fluid reservoir.

## Maintenance

### Service interval display

#### Service messages

You can obtain up-to-date information concerning the servicing of your vehicle from a qualified specialist workshop, e.g. an authorized Mercedes-Benz Center or at <http://www.mbusa.com> (USA only).

The ASSYST service interval display informs you of the next service due date.

If a service due date has been exceeded, you also hear a warning tone.

The multifunction display shows a service message for several seconds, e.g.:

Service A In 999,999 km

Service A in .. Days

Service A Due

Service A Exceeded 999,999 km

Service A Exceeded .. Days

Maintaining the time-dependent service schedule:

- ▶ Before disconnecting the battery, note down the service due date displayed.

or

- ▶ After reconnecting the battery, subtract the battery disconnection periods from the service date shown on the display.

The service interval display should not be confused with the  engine oil level display.

The symbol and the letter indicate which type of service is due:

 Minor service **A**

 Major service **B**







The ASSYST service interval display does not take into account any periods of time during which the battery is disconnected.

### Hiding a service message

- ▶ To hide the service message, press the  back button on the multifunction steering wheel (▷ page 161).

### Displaying service messages

Use the buttons on the multifunction steering wheel.

- ▶ Switch on the ignition.
- ▶ Press  or  to select the **standard display** menu on the steering wheel (▷ page 163).
- ▶ Press  or  to select the service interval display.  
The  or  service symbol and the service due date are displayed.

### Points to remember

The specified maintenance interval takes only the normal operation of the vehicle into account. Under arduous operating conditions or increased load on the vehicle, maintenance work must be carried out more frequently, for example:

- regular city driving with frequent intermediate stops
- if the vehicle is primarily used to travel short distances
- use in mountainous terrain or on poor road surfaces
- if the engine is often left idling for long periods

Under these or similar conditions, have, for example, the air filter, engine oil and oil filter replaced or changed more frequently. Under arduous operating conditions, the tires must be checked more often. Further information can be obtained at a qualified specialist workshop, e.g. an authorized Mercedes-Benz Center.

## Care

### General notes

- ❗ For cleaning your vehicle, do not use any of the following:
  - dry, rough or hard cloths
  - abrasive cleaning agents

- solvents
- cleaning agents containing solvents

Do not scrub.

Do not touch the surfaces or protective films with hard objects, e.g. a ring or ice scraper. You could otherwise scratch or damage the surfaces and protective film.

- ❗ Do not park your vehicle for a long period of time directly after cleaning, particularly after cleaning the wheel rim with wheel cleaner. Wheel cleaner can lead to the increased corrosion of the brake discs and pads. Therefore, drive for a few minutes after cleaning. By heating up the brakes, the brake discs and pads dry. The vehicle can then be parked for a long period of time.

### 🌿 Environmental note

Dispose of empty packaging and cleaning cloths in an environmentally responsible manner.

Regular care of your vehicle is a condition for retaining the quality in the long term.

Use care products and cleaning agents recommended and approved by Mercedes-Benz.

## Washing the vehicle and cleaning the paintwork

### Automatic car wash

#### ⚠️ WARNING

Braking efficiency is reduced after washing the vehicle. There is a risk of an accident.

After the vehicle has been washed, brake carefully while paying attention to the traffic conditions until full braking power is restored.

- ❗ When DISTRONIC PLUS or the HOLD function is activated, the vehicle brakes automatically in certain situations.

To avoid damage to the vehicle, deactivate DISTRONIC PLUS and the HOLD function in the following or similar situations:

- when towing the vehicle
- in the car wash

- ❗ Never clean your vehicle in a Touchless Automatic Car Wash as these use special

cleaning agents. These cleaning agents can damage the paintwork or plastic parts.

**!** Make sure that the automatic car wash is suitable for the size of the vehicle. Fold in the exterior mirrors before the vehicle is washed. The exterior mirrors could otherwise be damaged.

**!** Make sure that the automatic transmission is in transmission position **N** when washing your vehicle in a tow-through car wash. The vehicle may be damaged in another transmission position.

**!** Make sure that:

- the side windows and the sliding sunroof are fully closed.
- the blower is switched off.
- the windshield wiper switch is at position **0**.

The vehicle may otherwise be damaged.

You can wash the vehicle in an automatic car wash from the very start.

If the vehicle is very dirty, pre-wash it before cleaning it in an automatic car wash.

After using an automatic car wash, wipe off wax from the windshield and the wiper blades. This will prevent smears and reduce wiping noises caused by residue on the windshield.

### Washing by hand

In some countries, washing by hand is only allowed at specially equipped washing bays. Observe the legal requirements in each country.

When using the vehicle in winter, remove all traces of road salt deposits carefully and as soon as possible.

When washing the underside of the vehicle, also clean the insides of the wheels.

- ▶ Do not use hot water and do not wash the vehicle in direct sunlight.
- ▶ Use a soft sponge to clean.
- ▶ Use a mild cleaning agent, such as a car shampoo approved by Mercedes-Benz.
- ▶ Thoroughly hose down the vehicle with a gentle jet of water.
- ▶ Do not point the water jet directly towards the air inlet.
- ▶ Use plenty of water and rinse out the sponge frequently.

- ▶ Rinse the vehicle with clean water and dry thoroughly with a chamois.
- ▶ Do not let the cleaning agent dry on the paintwork.

### Power washers

#### WARNING

The water jet from a circular jet nozzle (dirt blasters) can cause invisible exterior damage to the tires or chassis components. Components damaged in this way may fail unexpectedly. There is a risk of an accident.

Do not use power washers with circular jet nozzles to clean the vehicle. Have damaged tires or chassis components replaced immediately.

**!** Always maintain a distance of at least 11.8 in (30 cm) between the vehicle and the power washer nozzle. Information about the correct distance is available from the equipment manufacturer.

Move the power washer nozzle around when cleaning your vehicle.

Do not aim directly at any of the following:

- Tires
- Door gaps, roof gaps, joints, etc.
- Electrical components
- Battery
- Connectors
- Lamps
- Seals
- Trim
- Ventilation slots

Damaged seals or electrical components can lead to leaks or failures.

**!** Vehicles with decorative film: parts of your vehicle are covered with a decorative film. Maintain a distance of at least 27.5 in (70 cm) between the parts of the vehicle covered with the film and the nozzle of the high pressure cleaner.

Information about the correct distance is available from the equipment manufacturer.

Move the power washer nozzle around when cleaning your vehicle.

## Cleaning the paintwork

**!** Do not affix:

- stickers
  - films
  - magnetic plates or similar items
- to painted surfaces. You could otherwise damage the paintwork.

Scratches, corrosive deposits, areas affected by corrosion and damage caused by inadequate care cannot always be completely repaired. In such cases, visit a qualified specialist workshop.

- ▶ Remove dirt immediately, where possible, while avoiding rubbing too hard.
- ▶ Soak insect remains with insect remover and rinse off the treated areas afterwards.
- ▶ Soak bird droppings with water and rinse off the treated areas afterwards.
- ▶ Remove coolant, brake fluid, tree resin, oils, fuels and greases by rubbing gently with a cloth soaked in petroleum ether or lighter fluid.
- ▶ Use tar remover to remove tar stains.
- ▶ Use silicone remover to remove wax.

If water no longer forms "beads" on the paint surface, use the paint care products recommended and approved by Mercedes-Benz. This is the case approximately every three to five months, depending on the climate conditions and the care product used.

The cleaning product Paint Cleaner, which has been recommended and approved by Mercedes-Benz, should be used when dirt has penetrated the paint surface.

Also use Paint Cleaner on paint that has become dull.

Do not use these care products in the sun or on the hood while the hood is hot.

- ▶ Use a suitable touch-up stick, e.g. MB Touch-Up Stick, to repair slight damage to the paintwork quickly and provisionally.

## Matte finish care

**!** Never polish the vehicle or the light alloy wheels. Polishing causes the finish to shine.

**!** The following may cause the paint to become shiny and thus reduce the matte effect:

- strong rubbing of the paintwork with unsuitable materials
- frequent use of automatic car washes
- washing the vehicle in direct sunlight

**!** Never use paint cleaner, buffing or polishing products, or gloss preserver, e.g. wax. These products are only suitable for high-gloss surfaces. Their use on vehicles with matte finish leads to considerable surface damage (shiny, spotted areas).

Always have paintwork repairs carried out at a qualified specialist workshop.

**!** Do not use wash programs with a hot wax treatment under any circumstances.

Observe these notes if your vehicle has a clear matte finish. This will help you to avoid damage to the paintwork due to incorrect treatment.

These notes also apply to light alloy wheels with a clear matte finish.

The vehicle should ideally be washed by hand using a soft sponge, car shampoo and plenty of water.

Use only insect remover and car shampoo from the range of approved Mercedes-Benz care products.

## Cleaning the vehicle parts

### Cleaning the wheels

#### WARNING

The water jet from a circular jet nozzle (dirt blasters) can cause invisible exterior damage to the tires or chassis components. Components damaged in this way may fail unexpectedly. There is a risk of an accident.

Do not use power washers with circular jet nozzles to clean the vehicle. Have damaged tires or chassis components replaced immediately.

**!** Do not use acidic wheel cleaning products to remove brake dust. This could damage wheel bolts and brake components.



**!** Do not park your vehicle for a long period of time directly after cleaning, particularly after cleaning the wheel rim with wheel cleaner. Wheel cleaner can lead to the increased corrosion of the brake discs and pads. Therefore, drive for a few minutes after cleaning. By heating up the brakes, the brake discs and pads dry. The vehicle can then be parked for a long period of time.

### Cleaning the windows

#### WARNING

You could become trapped by the windshield wipers if they start moving while cleaning the windshield or wiper blades. There is a risk of injury.

Always switch off the windshield wipers and the ignition before cleaning the windshield or wiper blades.

**!** Do not use dry cloths, abrasive products, solvents or cleaning agents containing solvents to clean the inside of the windows. Do not touch the insides of the windows with hard objects, e.g. an ice scraper or ring. There is otherwise a risk of damaging the windows.

**!** Clean the water drainage channels of the windshield and the rear window at regular intervals. Deposits such as leaves, petals and pollen may under certain circumstances prevent water from draining away. This can lead to corrosion damage and damage to electronic components.

▶ Clean the inside and outside of the windows with a damp cloth and a cleaning product that is recommended and approved by Mercedes-Benz.

### Cleaning wiper blades

#### WARNING

You could become trapped by the windshield wipers if they start moving while cleaning the windshield or wiper blades. There is a risk of injury.

Always switch off the windshield wipers and the ignition before cleaning the windshield or wiper blades.

**!** Do not pull the wiper blade. Otherwise, the wiper blade could be damaged.

**!** Do not clean wiper blades too often and do not rub them too hard. Otherwise, the graphite coating could be damaged. This could cause wiper noise.

**!** Hold the wiper arm securely when folding back. The windshield could be damaged if the wiper arm smacks against it suddenly.

- ▶ Fold the windshield wiper arms away from the windshield.
- ▶ Carefully clean the wiper blades with a damp cloth.
- ▶ Fold the windshield wiper arms back again before switching on the ignition.

### Cleaning the exterior lighting

**!** Only use cleaning agents or cleaning cloths which are suitable for plastic light lenses. Unsuitable cleaning agents or cleaning cloths could scratch or damage the plastic light lenses.

- ▶ Clean the plastic lenses of the exterior lighting using a wet sponge and a mild cleaning agent, e.g. Mercedes-Benz car shampoo or cleaning cloths.

### Cleaning the mirror turn signals

**!** Only use cleaning agents or cleaning cloths that are suitable for plastic lenses. Unsuitable cleaning agents or cleaning cloths could scratch or damage the plastic lenses of the mirror turn signals.

- ▶ Clean the plastic lenses of the mirror turn signals in the exterior mirror housing using a wet sponge and mild cleaning agent, e.g. Mercedes-Benz car shampoo or cleaning cloths.

### Cleaning the sensors

**!** If you clean the sensors with a power washer, make sure that you keep a distance of at least 11.8 in (30 cm) between the vehicle and the power washer nozzle. Information about the correct distance is available from the equipment manufacturer.

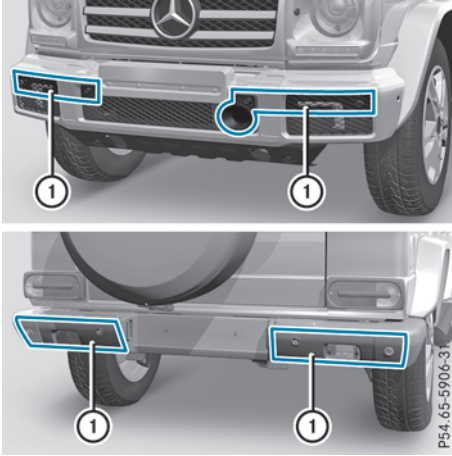

- Clean sensors ① of the driving systems with water, car shampoo and a soft cloth.

### Cleaning the rear view camera

- ❗ Do not clean the camera lens and the area around the rear view camera with a power washer.

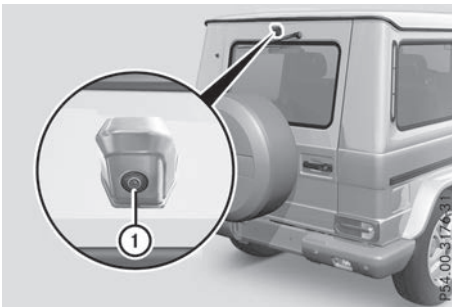

- Use clear water and a soft cloth to clean camera lens ①.

### Cleaning chrome parts

Impurities combined with the effects of road grit and corrosive environmental factors may cause flash rust to form on the surface. You can restore the original shine of chrome parts by cleaning them regularly, especially in winter and after washing.

- Clean chrome parts with a chrome care product tested and approved by Mercedes-Benz.

### Cleaning the exhaust pipe

#### ⚠ WARNING

The exhaust tail pipe and tail pipe trim can become very hot. If you come into contact with these parts of the vehicle, you could burn yourself. There is a risk of injury.

Always be particularly careful around the exhaust tail pipe and the tail pipe trim. Allow these components to cool down before touching them.

- ❗ Do not clean the exhaust pipe with acid-based cleaning agents, such as bathroom cleaner or wheel cleaner.

Impurities combined with the effects of road grit and corrosive environmental factors may cause flash rust to form on the surface. You can restore the original shine of the exhaust pipe by cleaning it regularly, especially in winter and after washing.

- Clean the exhaust pipe with a care product tested and approved by Mercedes-Benz.

### Cleaning the trailer tow hitch

- ❗ Do not clean the ball coupling with a power washer. Do not use solvents.
- ❗ Please note the care instructions in the trailer coupling manufacturer's operating instructions.

#### ♻ Environmental note

Dispose of rags soaked in oil and grease in an environmentally responsible manner.

The ball coupling must be cleaned if it becomes dirty or corroded.

- Remove rust, e.g. with a wire brush.
- After cleaning, lightly oil or grease the ball coupling.
- Check that the vehicle's trailer tow hitch is working properly.

You can also have the maintenance work on the ball coupling and the trailer tow hitch carried out by a qualified specialist workshop.

## Interior care

### Cleaning the display

❗ For cleaning, do not use any of the following:

- alcohol-based thinner or gasoline
- abrasive cleaning agents
- commercially-available household cleaning agents

These may damage the display surface. Do not put pressure on the display surface when cleaning. This could lead to irreparable damage to the display.

- ▶ Before cleaning the display, make sure that it is switched off and has cooled down.
- ▶ Clean the display surface using a commercially available microfiber cloth and TFT/LCD display cleaner.
- ▶ Dry the display surface using a dry microfiber cloth.

### Cleaning the plastic trim

#### WARNING

Care products and cleaning agents containing solvents cause surfaces in the cockpit to become porous. As a result, plastic parts may come loose in the event of air bag deployment. There is a risk of injury.

Do not use any care products and cleaning agents to clean the cockpit.

❗ Never attach the following to plastic surfaces:

- stickers
- films
- perfume oil container or similar

You could otherwise damage the plastic.

❗ Do not allow cosmetics, insect repellent or sunscreen to come into contact with the plastic trim. This maintains the high-quality look of the surfaces.

- ▶ Wipe the plastic trim with a damp, lint-free cloth, e.g. a microfiber cloth.
- ▶ **Heavy soiling:** use care and cleaning products recommended and approved by Mercedes-Benz. The surface may change color temporarily. Wait until the surface is dry again.

### Cleaning the steering wheel and selector lever

- ▶ Thoroughly wipe with a damp cloth or use leather care agents that have been recommended and approved by Mercedes-Benz.

### Cleaning genuine wood and trim elements

❗ Do not use solvent-based cleaning agents such as tar remover, wheel cleaners, polishes or waxes. There is otherwise a risk of damaging the surface.

❗ Do not use chrome polish for trim strips. The trim strips have a chrome look but are mostly made of anodized aluminum and can lose their shine if chrome polish is used. Use a damp, lint-free cloth instead when cleaning the trim strips.

If the chrome-plated trim strips are very dirty, you can use a chrome polish. If you are unsure as to whether the trim strips are chrome-plated or not, consult an authorized Mercedes-Benz Center.

- ▶ Wipe the wooden trim and trim pieces with a damp, lint-free cloth, e.g. a microfiber cloth.
- ▶ **Trim elements with piano black finish:** wipe with a soft, damp cotton cloth. Use clean water.
- ▶ **Heavy soiling:** use care and cleaning products recommended and approved by Mercedes-Benz.

### Cleaning the seat covers

#### General notes

❗ Do not use a microfiber cloth to clean covers made out of real leather, artificial leather or DINAMICA. If used often, these can damage the cover.

❗ Observe the following when cleaning:

- clean artificial leather covers with a cloth moistened with a solution containing 1% detergent (e.g. dish washing liquid).
- clean cloth covers with a microfiber cloth moistened with a solution containing 1% detergent (e.g. dish washing liquid). Rub carefully and always wipe entire seat sections to avoid leaving visible lines. Leave the seat to dry afterwards. Cleaning results

depend on the type of dirt and how long it has been there.

- clean DINAMICA covers with a damp cloth. Make sure that you wipe entire seat sections to avoid leaving visible lines.

Note that regular care is essential to ensure that the appearance and comfort of the covers is retained over time.

### Genuine leather seat covers

**!** To retain the natural appearance of the leather, observe the following cleaning instructions:

- Clean genuine leather covers carefully with a damp cloth and then wipe the covers down with a dry cloth.
- Make sure that the leather does not become soaked. It may otherwise become rough and cracked.
- Only use leather care agents that have been tested and approved by Mercedes-Benz. You can obtain these from a qualified specialist workshop.

Leather is a natural product.

It exhibits natural surface characteristics, for example:

- differences in the texture
- marks caused by growth and injury
- slight nuances of color

These are characteristics of leather and not material defects.

### Seat covers of other materials

**!** Observe the following when cleaning:

- clean artificial leather covers with a cloth moistened with a solution containing 1% detergent (e.g. dish washing liquid).
- clean cloth covers with a microfiber cloth moistened with a solution containing 1% detergent (e.g. dish washing liquid). Rub carefully and always wipe entire seat sections to avoid leaving visible lines. Leave the seat to dry afterwards. Cleaning results depend on the type of dirt and how long it has been there.
- clean DINAMICA covers with a damp cloth. Make sure that you wipe entire seat sections to avoid leaving visible lines.

### Cleaning the seat belts

#### WARNING

Seat belts can become severely weakened if bleached or dyed. This could cause the seat belts to tear or fail, for instance, in the event of an accident. This poses an increased risk of injury or fatal injury.

Never bleach or dye the seat belts.

**!** Do not clean the seat belts using chemical cleaning agents. Do not dry the seat belts by heating at temperatures above 176 °F (80 °C) or in direct sunlight.

- ▶ Use clean, lukewarm water and soap solution.

### Cleaning the headliner and carpets

▶ **Headliner:** if it is very dirty, use a soft brush or dry shampoo.

▶ **Carpets:** use the carpet and textile cleaning agents recommended and approved by Mercedes-Benz.

## Where will I find...?

## Reflective safety jacket

## Removing reflective safety jackets

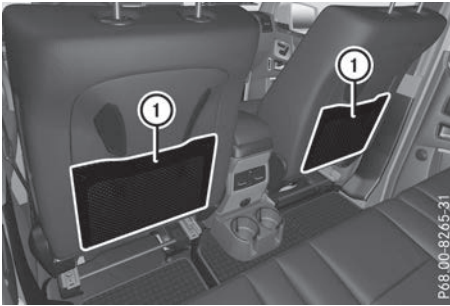

- Remove the reflective warning vests from card pockets ①.

## Information on reflective safety jackets

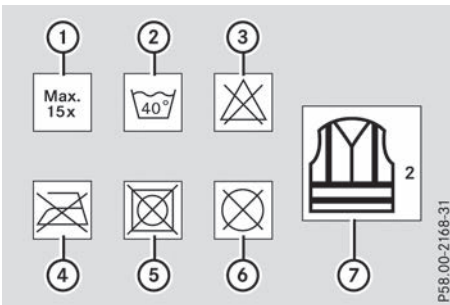

- ① Maximum number of washes
- ② Maximum wash temperature
- ③ Do not bleach
- ④ Do not iron
- ⑤ Do not use a laundry dryer
- ⑥ Do not dry-clean
- ⑦ This is a class 2 jacket

- The safety jackets only meet the requirements defined by the legal standard:
  - if the correct size is used
  - if the reflective safety jackets are correctly fastened
- Before use, ensure that the reflective safety jackets are clean and intact. The special properties may otherwise be compromised.

- The reflective safety jackets should be stored in their original packaging in a dry place away from sources of heat and light.
- The maximum number of washes specified is not the only factor influencing the life span of the reflective safety jackets. Their life span also depends on use, care, storage, etc.
- The reflective safety jackets should be disposed of and replaced with new ones:
  - after 15 washes, and/or
  - if the reflective strips have become scratched, and/or
  - if the backing material and/or reflective strips have become soiled and cannot be cleaned off, and/or
  - if the fluorescence has faded, for example due to the effects of sunlight
- Dispose of reflective safety jackets in an environmentally responsible manner. To do so, contact your local waste disposal company.

## Warning triangle

## Removing the warning triangle

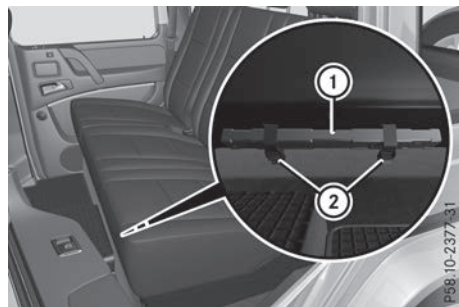

The warning triangle is secured under the rear bench seat.

- Release tabs ②.
- Remove warning triangle ①.

### Setting up the warning triangle

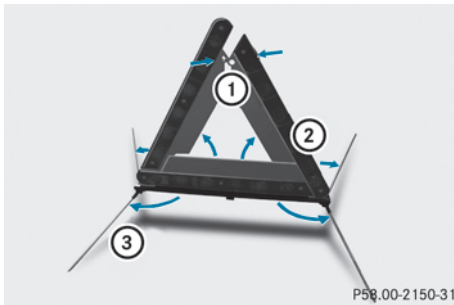

- ▶ Fold feet ③ down and out to the side.
- ▶ Pull side reflectors ② up to form a triangle and lock them at the top using press-stud ①.

### First-aid kit



The first-aid kit is located in the stowage compartment of the right-hand door.

- ▶ Remove first-aid kit ① from the stowage compartment.

Check the expiration date on the first-aid kit at least once a year. Replace the contents if necessary, and replace missing items.

### Vehicle tool kit

#### General notes

- ❗ When they leave the factory, vehicles are not equipped with the tools needed to change a wheel, such as a jack or lug wrench. Some tools for changing a wheel are specific to the vehicle. To obtain tools approved for your vehicle, contact a qualified specialist workshop.

The vehicle tool kit contains:

- vehicle tool kit bag with:
  - fuse extractor
  - a pump lever for the vehicle jack
  - a screwdriver
  - a lug wrench
- jack

### Vehicle tool kit

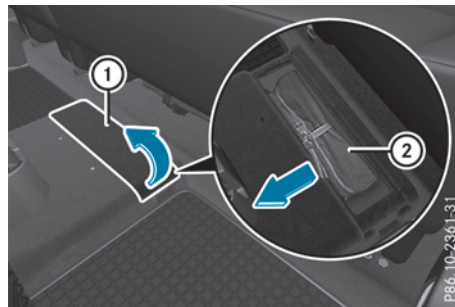

The vehicle tool kit is under the cover in the footwell in front of the rear bench seat.

- ▶ Fold cover ① to the side.
- ▶ Pull vehicle tool kit ② out by the tab.

### Jack

- ❗ Make sure that, while installing the vehicle jack, there are no cables on the holder, in order to avoid them becoming trapped.

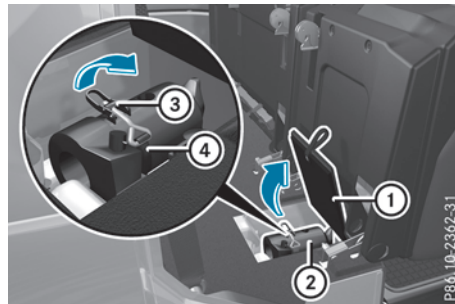

The jack is located under the rear bench seat on the right-hand side when viewed in the direction of travel.

- ▶ Fold rear bench seat forward (▷ page 213).
- ▶ Open cover ①.

- ▶ Pull bar ③ up and detach from tab ④.
- ▶ Remove jack ②.

### Exterior spare wheel bracket

#### General notes

When using a spare wheel of a different size, you must not exceed a maximum permissible speed of 50 mph (80 km/h).

If you mount the spare wheel, check the tire pressure.

- i** When changing a wheel, you should also observe the safety notes in the "Spare wheel" section (▷ page 279).

The spare wheel is on the outer side of the rear door.

#### Stainless-steel spare hub cap

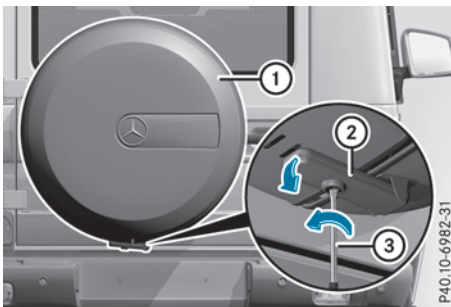

- ▶ Take the screwdriver out of the vehicle tool kit (▷ page 244).
- ▶ Open the lock on cover ring ① with screwdriver ③ or a similar tool.
- ▶ Fold tab ② down.

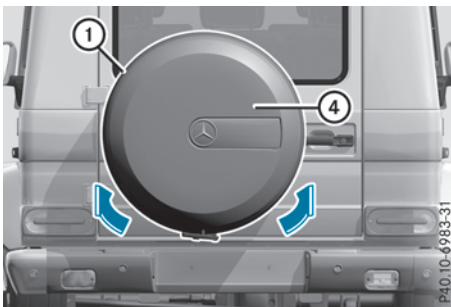

- ▶ Pull cover ring ① apart and remove it.
- ▶ Pull off trim panel ④.

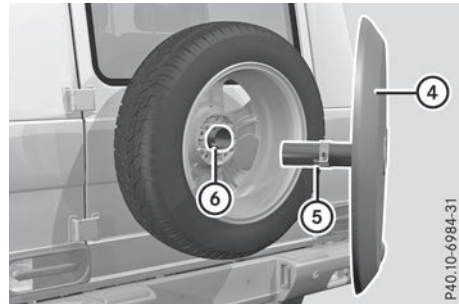

- ▶ When re-installing cover panel ④, make sure that retainer ⑤ engages into recess ⑥.

#### Removing the spare wheel

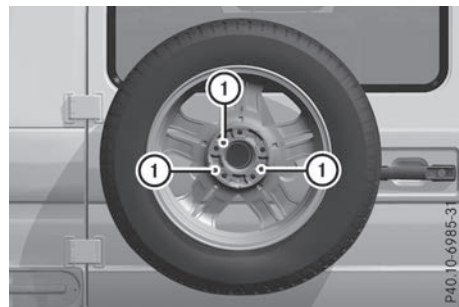

The spare wheel is heavy. Take particular note of this when removing the spare wheel.

- ▶ Remove wheel nuts ①.
- ▶ Remove the spare wheel.

#### Mounting the wheel

After changing a wheel:

- ▶ Repair or replace the damaged wheel as soon as possible and secure the spare wheel in place again.
- ▶ Secure the damaged wheel on the spare wheel bracket with wheel nuts ①. When doing so, make sure that the wheel cannot come loose.
- ▶ When re-installing trim panel ④, make sure that retainer ⑤ engages in recess ⑥ (▷ page 245).

- ▶ Make sure that tab ② is below when re-installing cover ring ① (▷ page 245).
- ▶ For safety reasons, regularly check to ensure that the wheel is securely fastened.

## Flat tire

### Preparing the vehicle

Observe the notes on changing a wheel (▷ page 275).

- ▶ Stop the vehicle on solid, non-slippery and level ground, as far away as possible from traffic.
- ▶ Switch on the hazard warning lamps.
- ▶ Secure the vehicle against rolling away (▷ page 122).
- ▶ If possible, bring the front wheels into the straight-ahead position.
- ▶ Switch off the engine.
- ▶ Remove the SmartKey from the ignition lock. The steering wheel lock stays active for as long as the SmartKey is removed.
- ▶ Make sure that the passengers are not endangered as they do so. Make sure that no one is near the danger area while a wheel is being changed. Anyone who is not directly assisting in the wheel change should, for example, stand behind the barrier.
- ▶ Get out of the vehicle. Pay attention to traffic conditions when doing so.
- ▶ Close the driver's door.
- ▶ Place the warning triangle a suitable distance away (▷ page 243). Observe legal requirements.

## Breakdown assistance

lead to function restrictions applying to safety-relevant systems, e.g. the lighting system, the ABS (anti-lock braking system) or the ESP® (Electronic Stability Program). The operating safety of your vehicle may be restricted.

You could lose control of the vehicle, for example:

- when braking
- in the event of abrupt steering maneuvers and/or when the vehicle's speed is not adapted to the road conditions

There is a risk of an accident.

In the event of a short circuit or a similar incident, contact a qualified specialist workshop immediately. Do not drive any further. You should have all work involving the battery carried out at a qualified specialist workshop.

For further information about ABS and ESP®, see (▷ page 58) and (▷ page 59).

### WARNING

Electrostatic build-up can lead to the creation of sparks, which could ignite the highly explosive gases of a battery. There is a risk of an explosion.

Before handling the battery, touch the vehicle body to remove any existing electrostatic build-up.

The highly flammable gas mixture forms when charging the battery as well as when jump-starting.

Always make sure that neither you nor the battery is electrostatically charged. A build-up of electrostatic charge can be caused, for example:

- by wearing clothing made from synthetic fibers
- due to friction between clothing and seats
- if you push or pull the battery across the carpet or other synthetic materials
- if you rub the battery with a cloth

## Battery (vehicle)

### Important safety notes

Special tools and expert knowledge are required when working on the battery, e.g. removal and installation. You should therefore have all work involving the battery carried out at a qualified specialist workshop.

### WARNING

Work carried out incorrectly on the battery can lead, for example, to a short circuit and thus damage the vehicle electronics. This can

### WARNING

During the charging process, a battery produces hydrogen gas. If a short circuit occurs or



sparks are created, the hydrogen gas can ignite. There is a risk of an explosion.

- Make sure that the positive terminal of a connected battery does not come into contact with vehicle parts.
- Never place metal objects or tools on a battery.
- It is important that you observe the described order of the battery terminals when connecting and disconnecting a battery.
- When jump-starting, make sure that the battery poles with identical polarity are connected.
- It is particularly important to observe the described order when connecting and disconnecting the jumper cables.
- Never connect or disconnect the battery terminals while the engine is running.

 **WARNING**

Battery acid is caustic. There is a risk of injury. Avoid contact with skin, eyes or clothing. Do not inhale any battery gases. Do not lean over the battery. Keep children away from batteries. Wash away battery acid immediately with plenty of clean water and seek medical attention.

 **Environmental note**



Batteries contain dangerous substances. It is against the law to dispose of them with the household rubbish. They must be collected separately and recycled to protect the environment.



Dispose of batteries in an environmentally friendly manner. Take discharged batteries to a qualified specialist workshop or a special collection point for used batteries.

 Have the battery checked regularly at a qualified specialist workshop.

Observe the service intervals in the Maintenance Booklet or contact a qualified specialist workshop for more information.

 Always have work on batteries carried out at a qualified specialist workshop.

Should it, in exceptional circumstances, be absolutely necessary to disconnect the 12-volt battery yourself, please observe the following:

- Secure the vehicle to prevent it from rolling away.
- Switch off the ignition.
- Disconnect the negative terminal first and then the positive terminal.

The transmission is locked in position **P** after disconnecting the battery.

After the work has been done, install the battery and replace the cover of the positive terminal clamp firmly.

Comply with safety precautions and take protective measures when handling batteries.



Risk of explosion.



Fire, open flames and smoking are prohibited when handling the battery. Avoid creating sparks.



Battery acid is caustic. Avoid contact with skin, eyes or clothing.



Wear eye protection.



Keep children away.



Observe this Operator's Manual.

For safety reasons, Mercedes-Benz recommends that you only use batteries which have been tested and approved for your vehicle by Mercedes-Benz. These batteries provide increased impact protection to prevent vehicle occupants from suffering acid burns should the battery be damaged in the event of an accident.



In order for the battery to achieve the maximum possible service life, it must always be sufficiently charged.

Like other batteries, the vehicle battery may discharge over time if you do not use the vehicle. In this case, have the battery disconnected at a qualified specialist workshop. You can also charge the battery with a charger recommended by Mercedes-Benz. Contact a qualified specialist workshop for further information.

Have the battery condition of charge checked more frequently if you use the vehicle mainly for short trips or if you leave it standing idle for a lengthy period. Consult a qualified specialist workshop if you wish to leave your vehicle parked for a long period of time.

Remove the SmartKey if you park the vehicle and do not require any electrical consumers. The vehicle will then use very little energy, thus conserving battery power.

- i** If the power supply has been interrupted, e.g. due to a discharged battery, you will have to:
- reset the head restraints on the front seats (▷ page 76)
  - reset the function for automatically folding the exterior mirrors in/out by folding the mirrors out once (▷ page 82)

### Charging the battery

- !** Only use battery chargers with a maximum charging voltage of 14.8 V.

#### WARNING

During charging and jump-starting, explosive gases can escape from the battery. There is a risk of an explosion.

Particularly avoid fire, open flames, creating sparks and smoking. Ensure there is sufficient ventilation while charging and jump-starting. Do not lean over a battery.

#### WARNING

Battery acid is caustic. There is a risk of injury. Avoid contact with skin, eyes or clothing. Do not inhale any battery gases. Do not lean over

the battery. Keep children away from batteries. Wash away battery acid immediately with plenty of clean water and seek medical attention.

#### WARNING

A discharged battery can freeze at temperatures below freezing point. When jump-starting the vehicle or charging the battery, gases can escape from the battery. There is a risk of an explosion.

Allow the frozen battery to thaw out before charging it or jump-starting.

- !** Only charge the battery using the jump-starting connection point.

The jump-starting connection point is in the engine compartment (▷ page 249).

- ▶ Open the hood.
- ▶ Connect the battery charger to the positive terminal and ground point in the same order as when connecting the donor battery in the jump-starting procedure (▷ page 249).

Keep away from fire and open flames. Do not lean over a battery. Never charge the battery if it is still installed in the vehicle, unless you use a battery charger which has been tested and approved by Mercedes-Benz. A battery charger unit specially adapted for Mercedes-Benz vehicles and tested and approved by Mercedes-Benz is available as an accessory. It permits the charging of the battery in its installed position. Contact an authorized Mercedes-Benz Center for further information and availability. Read the battery charger's operating instructions before charging the battery.

If the warning and indicator lamps do not light up on the instrument cluster when temperatures are low, it is probably because the discharged battery has frozen. In this case you may neither jump-start the vehicle nor charge the battery. The service life of a thawed-out battery may be shorter. The starting characteristics can be impaired, particularly at low temperatures. Have the thawed-out battery checked at a qualified specialist workshop.

## Jump starting

For the jump-starting procedure, use only the jump-starting connection point in the engine compartment, consisting of a positive terminal and a ground point.

### WARNING

Battery acid is caustic. There is a risk of injury.

Avoid contact with skin, eyes or clothing. Do not inhale any battery gases. Do not lean over the battery. Keep children away from batteries. Wash away battery acid immediately with plenty of clean water and seek medical attention.

### WARNING

During charging and jump-starting, explosive gases can escape from the battery. There is a risk of an explosion.

Particularly avoid fire, open flames, creating sparks and smoking. Ensure there is sufficient ventilation while charging and jump-starting. Do not lean over a battery.

### WARNING

During the charging process, a battery produces hydrogen gas. If a short circuit occurs or sparks are created, the hydrogen gas can ignite. There is a risk of an explosion.

- Make sure that the positive terminal of a connected battery does not come into contact with vehicle parts.
- Never place metal objects or tools on a battery.
- It is important that you observe the described order of the battery terminals when connecting and disconnecting a battery.
- When jump-starting, make sure that the battery poles with identical polarity are connected.
- It is particularly important to observe the described order when connecting and disconnecting the jumper cables.
- Never connect or disconnect the battery terminals while the engine is running.

### WARNING

A discharged battery can freeze at temperatures below freezing point. When jump-starting the vehicle or charging the battery, gases can escape from the battery. There is a risk of an explosion. Allow the frozen battery to thaw out before charging it or jump-starting.

- ⚠ Avoid repeated and lengthy starting attempts. Otherwise, the catalytic converter could be damaged by the non-combusted fuel.

If the warning and indicator lamps do not light up on the instrument cluster when temperatures are low, it is probably because the discharged battery has frozen. In this case, you may neither charge the battery nor jump-start the vehicle. The service life of a thawed-out battery may be shorter. The starting characteristics can be impaired, particularly at low temperatures. Have the thawed-out battery checked at a qualified specialist workshop.

Do not start the vehicle using a rapid charging device. If your vehicle's battery is discharged, the engine can be jump-started from another vehicle or from a donor battery using jumper cables. Observe the following points:

- The battery is not accessible in all vehicles. If the other vehicle's battery is not accessible, jump-start the vehicle using a donor battery or a jump-starting device.
- You may only jump-start the vehicle when the engine and exhaust system are cold.
- Do not start the engine if the battery is frozen. Let the battery thaw first.
- Jump-starting may be performed only using batteries with a nominal voltage of 12 V.
- Only use jumper cables which have a sufficient cross-section and insulated terminal clamps.
- If the battery is fully discharged, leave the battery that is being used to jump-start connected for a few minutes before attempting to start. This charges the battery slightly.
- Make sure that the two vehicles do not touch.

Make sure that:

- The jumper cables are not damaged.
  - When the jumper cables are connected to the battery, uninsulated sections of the terminal clamp do not come into contact with other metal sections.
  - The jumper cables cannot come into contact with parts which can move when the engine is running, such as the V-belt pulley or the fan.
- Apply the parking brake.
- Shift the automatic transmission to position **P**.
- Make sure that the ignition is switched off. All indicator lamps in the instrument cluster must be off.
- Switch off all electrical consumers, e.g. rear window defroster, lighting, etc.
- Open the hood.

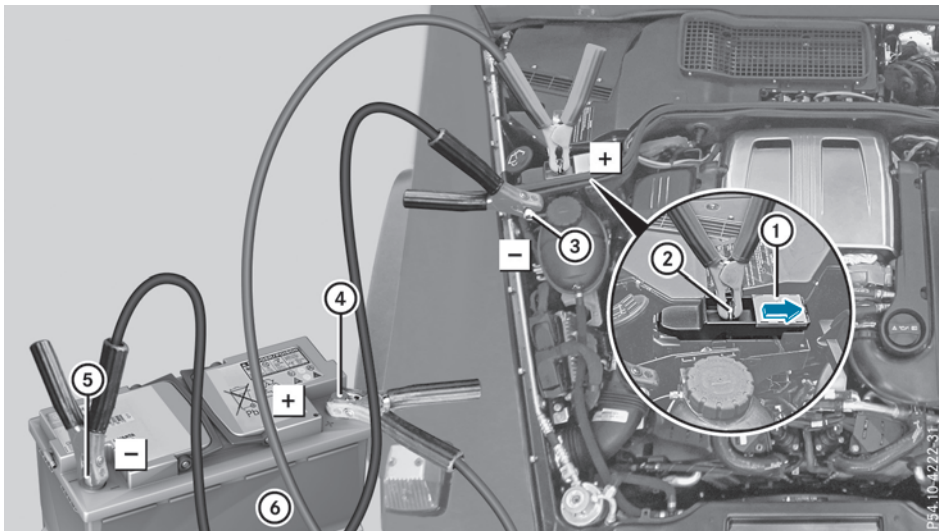

Position number ⑥ identifies the charged battery of the other vehicle or an equivalent jump-starting device.

The jump-starting connection point consists of contacts ② and ③.

- ▶ Lift up cover ① of positive terminal ② in the direction of the arrow.
- ▶ Connect positive terminal ② on your vehicle to positive terminal ④ of donor battery ⑥ using the jumper cable. Always begin with positive terminal ② on your own vehicle first.
- ▶ Start the engine of the donor vehicle and run it at idling speed.
- ▶ Connect negative terminal ⑤ of donor battery ⑥ to ground point ③ of your vehicle using the jumper cable, connecting the jumper cable to donor battery ⑥ first.
- ▶ Start the engine.
- ▶ Before disconnecting the jumper cables, let the engine run for several minutes.
- ▶ First, remove the jumper cables from ground point ③ and negative terminal ⑤, then from positive clamp ② and positive terminal ④. Begin each time at the contacts on your own vehicle first.
- ▶ Close cover ① of positive terminal ② after removing the jumper cables.
- ▶ Have the battery checked at a qualified specialist workshop.

Jump-starting is not considered to be a normal operating condition.

- i** Jumper cables and further information regarding jump-starting can be obtained at any qualified specialist workshop.

## Towing and tow-starting

### Important safety notes

#### WARNING

Functions relevant to safety are restricted or no longer available if:

- the engine is not running.
- the brake system or the power steering is malfunctioning.
- there is a malfunction in the voltage supply or the vehicle's electrical system.

If your vehicle is being towed, much more force may be necessary to steer or brake. There is a risk of an accident.

In such cases, use a tow bar. Before towing, make sure that the steering moves freely.

#### WARNING

You can no longer steer the vehicle if the steering wheel lock has been engaged. There is a risk of an accident.

Always switch off the ignition when towing the vehicle with a tow cable or a tow bar.

#### WARNING

When towing or tow-starting another vehicle and its weight is greater than the permissible gross weight of your vehicle, the:

- the towing eye could detach itself
- the vehicle/trailer combination could roll-over.

There is a risk of an accident.

When towing or tow-starting another vehicle, its weight should not be greater than the permissible gross weight of your vehicle.

Details on the permissible gross vehicle weight of your vehicle can be found on the vehicle identification plate (▷ page 282).

- !** When DISTRONIC PLUS or the HOLD function is activated, the vehicle brakes automatically in certain situations.

To avoid damage to the vehicle, deactivate DISTRONIC PLUS and the HOLD function in the following or similar situations:

- when towing the vehicle
- in the car wash

- !** The vehicle can be towed a maximum of 30 miles (50km). The towing speed of 30 mph (50 km/h) must not be exceeded.

If the vehicle has to be towed more than 30 miles (50km), the entire vehicle must be raised and transported.

❗ Only secure the tow cable or tow bar to the towing eyes. You could otherwise damage the vehicle.

❗ Do not tow with sling-type equipment. This could damage the vehicle.

❗ Do not use the towing eye for recovery. This could damage the vehicle. If in doubt, have the vehicle recovered using a crane.

❗ When towing, pull away slowly and smoothly. If the tractive power is too high, the vehicles could be damaged.

❗ Your vehicle is equipped with an automatic transmission. Therefore, you must not have the vehicle tow-started. The transmission may otherwise be damaged.

It is better to have the vehicle transported than to have it towed away.

If the transfer case can be shifted into the **Neutral** position, you can tow away the vehicle.

If the transfer case cannot be shifted into the **Neutral** position, you can tow away the vehicle with one axle raised. Please bear the following in mind:

- remove the propeller shaft between the transfer case and the rolling axle
- turn the SmartKey to position **1** in the ignition lock

The battery must be connected and charged. Otherwise, you:

- cannot turn the SmartKey to position **2** in the ignition lock
- cannot shift the automatic transmission to position **N**

Disarm the automatic locking feature before the vehicle is towed (> page 67). You could otherwise be locked out when pushing or towing the vehicle.

## Towing eyes

### Towing eyes, front

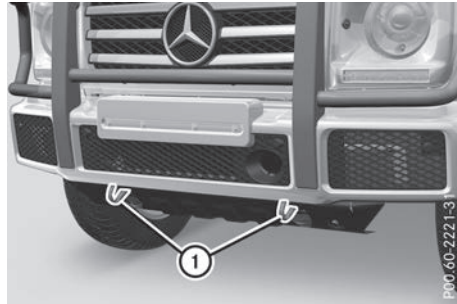

① Towing eyes, front

### Towing eye, rear

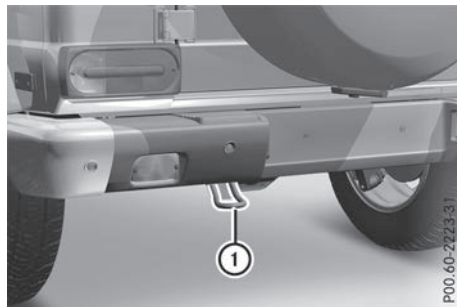

Rear towing eye ① is located under the bumper, on the left-hand side when viewed in the direction of travel.

## Towing a vehicle with both axles on the ground

It is important that you observe the safety instructions when towing away your vehicle (> page 251).

The automatic transmission automatically shifts to position **P** when you open the driver's or front-passenger door or when you remove the SmartKey from the ignition lock. In order to ensure that the automatic transmission stays in position **N** when towing away the vehicle, you must observe the following points:

- ▶ Make sure that the vehicle is stationary.
- ▶ Turn the SmartKey to position **2** in the ignition lock.

- ▶ When the vehicle is stationary, depress the brake pedal and keep it depressed.
- ▶ Shift the transfer case to position **Neutral** (▷ page 150).
- ▶ Shift the automatic transmission to position **N**.
- ▶ Leave the SmartKey in position **2** in the ignition lock.
- ▶ Release the brake pedal.
- ▶ Release the parking brake.
- ▶ Switch on the hazard warning lamps (▷ page 88).

In order to signal a change of direction when towing the vehicle with the hazard warning lamps switched on, use the combination switch as usual. In this case, only the indicator lamps for the direction of travel flash. After resetting the combination switch, the hazard warning lamp starts flashing again.

**i** The automatic transmission can only change gear when the battery has sufficient charge.

If you cannot shift the automatic transmission to position **N**, the propeller shafts to the driven axles must be removed.

### Transporting the vehicle

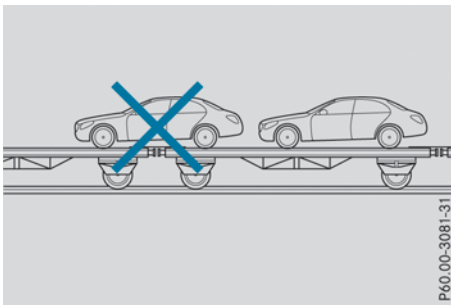

**!** When the vehicle is loaded for transport, the front and rear axles must be stationary and on the same transportation vehicle. Positioning over the connection point of the transport vehicle is not permitted. The drive train may otherwise be damaged.

**!** You may only secure the vehicle by the wheels, not by parts of the vehicle such as axle or steering components. Otherwise, the vehicle could be damaged.

The towing eyes can be used to pull the vehicle onto a trailer or transporter if you wish to transport it.

- ▶ Turn the SmartKey to position **2** in the ignition lock.
- ▶ Shift the transfer case to position **Neutral** (▷ page 150).
- ▶ Shift the automatic transmission to position **N**.

### As soon as the vehicle has been loaded:

- ▶ Apply the parking brake.
- ▶ Shift the automatic transmission to position **P**.
- ▶ Turn the SmartKey to position **0** in the ignition lock and remove it.
- ▶ Secure the vehicle.

### Recovering a vehicle that has become stuck

**!** When recovering a vehicle that has become stuck, pull it as smoothly and evenly as possible. Excessive tractive power could damage the vehicles.

If the drive wheels have become stuck in loose or muddy ground, pull the vehicle out with extreme caution, especially so if the vehicle is loaded.

Never attempt to recover a stuck vehicle with a trailer attached.

Pull out the vehicle backwards, if possible using the tracks it made when it became stuck.

### Towing in the event of malfunctions

#### General notes

**!** If you are removing the propeller shaft, use M10 nuts as spacers on the M8 bolts and secure them with M8 nuts.

New self-locking nuts must be used when the propeller shafts are refitted.

It is important that you observe the safety instructions when towing away your vehicle (▷ page 251).

**i** Consult an authorized Mercedes-Benz Center.

### In the event of damage to the engine, transmission or electrical system

- ▶ Shift the transfer case to **neutral** (▷ page 150).
- ▶ Shift the automatic transmission to position **N**.

### In the event of damage to the transfer case

Have the propeller shafts between the axles and the transfer case removed.

### In the event of damage to the front axle

Have the propeller shaft between the rear axle and the transfer case removed.

Then have the vehicle towed away with the front axle raised.

### In the event of damage to the rear axle

Have the propeller shaft between the front axle and the transfer case removed.

Then have the vehicle towed with the rear axle raised and wheel rollers under the front axle.

### Tow-starting (emergency engine starting)

- ❗ Vehicles with automatic transmission must not be tow-started. You could otherwise damage the automatic transmission.

You can find information on "Jump-starting" under (▷ page 249).

## Fuses

### Important safety notes

#### WARNING

If you manipulate or bridge a faulty fuse or if you replace it with a fuse with a higher amperage, the electric cables could be overloaded. This could result in a fire. There is a risk of an accident and injury.

Always replace faulty fuses with the specified new fuses having the correct amperage.

The fuses in your vehicle serve to close down faulty circuits. If a fuse blows, all the components on the circuit and their functions stop operating.

Blown fuses must be replaced with fuses of the same rating, which you can recognize by the color and value. The fuse ratings are listed in the fuse allocation chart (▷ page 255).

If a newly inserted fuse also blows, have the cause traced and rectified at a qualified specialist workshop, e.g. an authorized Mercedes-Benz Center.

- ❗ Only use fuses that have been approved for Mercedes-Benz vehicles and which have the correct fuse rating for the system concerned. Otherwise, components or systems could be damaged.
- ❗ Make sure that no moisture can enter the fuse box when the cover is open.
- ❗ When closing the cover, make sure that it is lying correctly on the fuse box. Moisture seeping in or dirt could otherwise impair the operation of the fuses.

### Before changing a fuse

Pay attention to the important safety notes (▷ page 254).

- ▶ Switch off the engine.
- ▶ Switch off all electrical consumers.
- ▶ Remove the SmartKey from the ignition lock. All indicator lamps in the instrument cluster must be off.
- ▶ Secure the vehicle against rolling away (▷ page 122).

The fuses are located in various fuse boxes:

- Main fuse box on the front-passenger side of the dashboard
- Fuse box in the front-passenger footwell
- Fuse box in the transmission tunnel
- Fuse box in the cargo compartment

The fuse allocation chart and the spare fuses are in the fuse box on the dashboard on the front-passenger side (▷ page 255).

The fuse extractor is in the vehicle tool kit (▷ page 244).



### Dashboard fuse box

**!** Do not use a pointed object such as a screwdriver to open the cover in the dashboard. You could damage the dashboard or the cover.

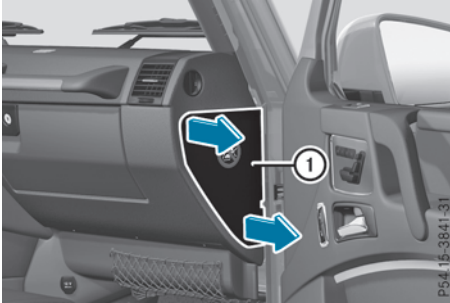

- ▶ Open the front-passenger door.
- ▶ **To open:** pull cover ① out in the direction of the arrow and remove it.
- ▶ **To close:** clip in cover ① on the front of the dashboard.
- ▶ Fold cover ① in until it engages.

### Fuse box in the front-passenger footwell

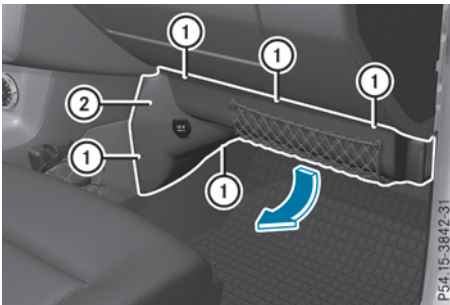

- ▶ Unscrew screws ①.
- ▶ Lift up cover ② in the direction of the arrow.

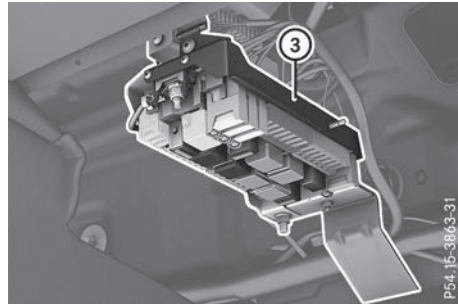

③ Fuse box

### Fuse box in the transmission tunnel

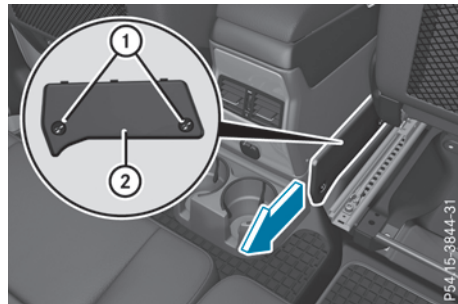

- ▶ Fold the cup holder on the center console down (▷ page 215).
- ▶ Move the front-passenger seat as far forward as possible (▷ page 76).
- ▶ **To open:** unscrew screws ①.
- ▶ Remove cover ② in the direction of the arrow.
- ▶ **To close:** clip in cover ②.
- ▶ Install cover ② with screws ①.

## Fuse box in the cargo compartment

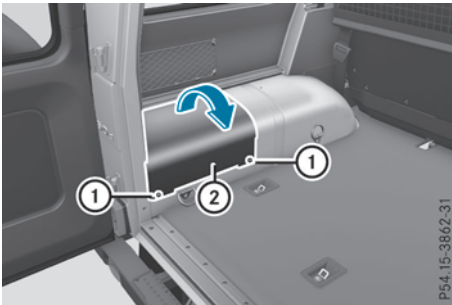

- ▶ Open the rear door.
- ▶ **To open:** unscrew screws ①.
- ▶ Lift up cover ② in the direction of the arrow and remove it.

## Important safety notes

### WARNING

If wheels and tires of the wrong size are used, the wheel brakes or suspension components may be damaged. There is a risk of an accident.

Always replace wheels and tires with those that fulfill the specifications of the original part.

When replacing wheels, make sure to use the correct:

- designation
- model

When replacing tires, make sure to use the correct:

- designation
- manufacturer
- model

### Warning

A flat tire severely impairs the driving, steering and braking characteristics of the vehicle. There is a risk of an accident.

do not drive with a flat tire. Immediately replace the flat tire with your spare wheel, or consult a qualified specialist workshop.

Accessories that are not approved for your vehicle by Mercedes-Benz or are not being used correctly can impair the operating safety.

Before purchasing and using non-approved accessories, visit a qualified specialist workshop and ask about:

- suitability
- legal stipulations
- factory recommendations

Further information regarding wheels and tires can be found under "Wheel/tire combinations" (▷ page 279).

You can ask for information regarding permitted wheel/tire combinations at an authorized Mercedes-Benz Center.

Information on tire pressure can be found:

- on the Tire and Loading Information placard on the B-pillar on the driver's side (▷ page 266)
- in the tire pressure table in the fuel filler flap (▷ page 120)
- under "Tire pressure" (▷ page 260)

## Operation

### Information on driving

Check the tire pressure when the vehicle is heavily laden and adjust prior to a trip.

While driving, pay attention to vibrations, noises and unusual handling characteristics, e.g. pulling to one side. This may indicate that the wheels or tires are damaged. If you suspect that a tire is defective, reduce your speed immediately. Stop the vehicle as soon as possible to check the wheels and tires for damage. Hidden tire damage could also be causing the unusual handling characteristics. If you find no signs of damage, have the tires and wheels checked at a qualified specialist workshop.

When parking your vehicle, make sure that the tires do not get deformed by the curb or other obstacles. If they cannot be avoided, drive over obstacles such as curbs slowly and at an obtuse angle. You could otherwise damage the wheel rims and tires.

### Regular checking of wheels and tires

#### WARNING

Damaged tires can cause tire inflation pressure loss. As a result, you could lose control of your vehicle. There is a risk of accident.

Check the tires regularly for signs of damage and replace any damaged tires immediately.

Check wheels and tires for damage at least once a month. Check wheels and tires after driving off-road or on rough roads. Damaged wheels can cause a loss of tire pressure.

Pay particular attention to damage such as:

- cuts in the tires
- punctures in the tires
- tears in the tires

- bulges on tires
- deformation or severe corrosion on wheels

Regularly check the tire tread depth and the condition of the tread across the whole width of the tire (▷ page 258). In order to inspect the inner side of the tire surface, turn the steering wheel to full lock.

All wheels must have a valve cap to protect the valve against dirt and moisture. Do not install anything onto the valve other than the standard valve cap or a valve cap approved by Mercedes-Benz for your vehicle. Do not use any other valve caps or systems, e.g. tire pressure monitoring systems.

You should regularly check the pressure of all your tires including the spare wheel, particularly prior to long trips. Adjust the tire pressure as necessary (▷ page 260).

The service life of tires depends, among other things, on the following factors:

- Driving style
- Tire pressure
- Distance covered

### Notes on tire tread

#### WARNING

Insufficient tire tread will reduce tire traction. The tire is no longer able to dissipate water. This means that on wet road surfaces, the risk of hydroplaning increases, in particular where speed is not adapted to suit the driving conditions. There is a risk of accident.

If the tire pressure is too high or too low, tires may exhibit different levels of wear at different locations on the tire tread. Thus, you should regularly check the tread depth and the condition of the tread across the entire width of all tires.

Minimum tire tread depth for:

- Summer tires:  $\frac{1}{8}$  in (3 mm)
- M+S tires:  $\frac{1}{8}$  in (4 mm)

For safety reasons, replace the tires before the legally prescribed limit for the minimum tire tread depth is reached.

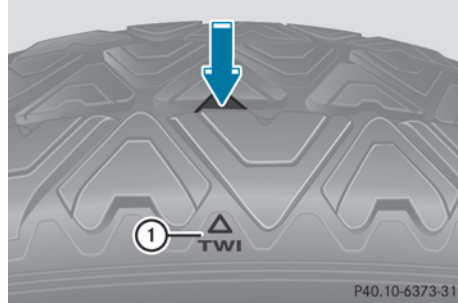

Marking ① shows where the bar indicator (arrow) for tread wear is integrated into the tire tread.

Treadwear indicators (TWI) are required by law. Six indicators are positioned on the tire tread. They are visible once a tread depth of approximately  $\frac{1}{16}$  in (1.6 mm) has been reached. If this is the case, the tire is so worn that it must be replaced.

### Selecting, mounting and replacing tires

- Only mount tires and wheels of the same type and make.
- Only mount tires of the correct size onto the wheels.
- Break in new tires at moderate speeds for the first 60 miles (100 km). The new tires only reach their full performance after this distance.
- Do not drive with tires which have too little tread depth, as this significantly reduces the traction on wet roads (hydroplaning).
- Replace the tires after six years at the latest, regardless of wear. This also applies to the spare wheel.

### Winter operation

#### General notes

Have your vehicle winter-proofed at a qualified specialist workshop at the onset of winter.

Observe the notes in the "Changing a wheel" section (▷ page 275).

### Driving with summer tires

At temperatures below 45 °F (+7 °C), elasticity in summer tires is significantly lower and thus also traction and braking power. Change the tires on your vehicle to M+S tires. Using summer tires at very cold temperatures could cause cracks to form, thereby damaging the tires permanently. Mercedes-Benz cannot accept responsibility for this type of damage.

#### WARNING

Damaged tires can cause tire inflation pressure loss. As a result, you could lose control of your vehicle. There is a risk of accident.

Check the tires regularly for signs of damage and replace any damaged tires immediately.

### M+S tires

#### WARNING

M+S tires with a tire tread depth of less than  $\frac{1}{8}$  in (4 mm) are not suitable for use in winter and do not provide sufficient traction. There is a risk of an accident.

M+S tires with a tread depth of less than  $\frac{1}{8}$  in (4 mm) must be replaced immediately.

#### WARNING

Wheel and tire dimensions as well as the type of tire can vary between the spare wheel and the wheel to be replaced. When the spare wheel is mounted, driving characteristics may be severely affected. There is a risk of an accident.

In order to reduce risks:

- you should therefore adapt your driving style and drive carefully.
- never mount more than one spare wheel that differs from the wheel to be replaced.
- only use a spare wheel that differs from the wheel to be replaced for a short time.
- do not deactivate ESP®.
- have a spare wheel that differs from the wheel that has been changed replaced at the nearest qualified specialist workshop.

You must observe the correct wheel and tire dimensions as well as the wheel type.

Do not exceed a maximum speed of 50 mph (80 km/h) if a spare wheel of a different size is installed.

At temperatures below 45 °F (+7 °C), use winter tires or all-season tires. Both types of tire are identified by the M+S marking.

Only winter tires bearing the  snowflake symbol in addition to the M+S marking provide the best possible grip in wintry road conditions. Only these tires will allow driving safety systems such as ABS and ESP® to function optimally in winter. These tires have been developed specifically for driving in snow.

Use M+S tires of the same make and tread on all wheels to maintain safe handling characteristics.

Always observe the maximum permissible speed specified for the M+S tires you have mounted.

When you have mounted the M+S tires:

- ▶ Check the tire pressures (> page 263).
- ▶ Restart the tire pressure monitor (> page 265).

### Snow chains

#### WARNING

If you drive too fast with snow chains mounted, they may snap. As a result, you could injure others and damage the vehicle. There is a risk of an accident.

Observe the maximum permissible speed for operation with snow chains.

 Information about the use of snow chain compatible AMG winter tires is applicable for AMG tires. Use of snow chains is only permissible with these tires.

 On some tire sizes there is not enough space for snow chains. To avoid damage to the vehicle or tires, observe the "Wheel and tire combinations" section under "Tires and wheels".

**!** Check the snow chains for damage before mounting them. Damaged or worn snow chains may snap and damage the following components:

- wheel
- wheel housing
- wheel suspension

For this reason, you must use only snow chains that are free of defects. Observe the manufacturer's mounting instructions.

For safety reasons, Mercedes-Benz recommends that you only use snow chains that have been specially approved for your vehicle by Mercedes-Benz, or are of a corresponding standard of quality. For more information, please contact a qualified specialist workshop. If you intend to mount snow chains, please bear the following points in mind:

- Snow chains may not be mounted on all wheel/tire combinations. Observe the information regarding permitted wheel/tire combinations (▷ page 279).
- Install the snow chains on all four wheels for maximum tractive power and driving stability. If you only have two snow chains, install these as a pair on the rear wheels. The vehicle then remains more stable under braking.
- Only use snow chains when driving on roads completely covered by snow. Remove the snow chains as soon as possible when you come to a road that is not snow-covered.
- Local regulations may restrict the use of snow chains. Observe the appropriate regulations if you wish to mount snow chains.
- Do not exceed the maximum permissible speed of 30 mph (50 km/h).

You may wish to deactivate ESP® when pulling away with snow chains installed (▷ page 59). You can thereby allow the wheels to spin in a controlled manner, achieving an increased driving force (cutting action).

## Tire pressure

### Tire pressure specifications

#### Important safety notes

##### WARNING

Underinflated or overinflated tires pose the following risks:

- the tires may burst, especially as the load and vehicle speed increase.
- the tires may wear excessively and/or unevenly, which may greatly impair tire traction.
- the driving characteristics, as well as steering and braking, may be greatly impaired.

There is a risk of an accident.

Follow recommended tire inflation pressures and check the pressure of all the tires including the spare wheel:

- monthly, at least
- if the load changes
- before beginning a long journey
- under different operating conditions, e.g. off-road driving

If necessary, correct the tire pressure.

The data on the Tire and Loading Information placard and tire pressure table shown here are examples. Tire pressure specifications are vehicle-specific and may deviate from the data shown here. The tire pressure specifications that are valid for your vehicle can be found on the Tire and Loading Information placard and tire pressure table on the vehicle.

#### General notes

The recommended tire pressures for the tires mounted at the factory can be found on the labels described here.

**Operation with a trailer:** the applicable value for the rear axle is the maximum tire pressure value stated in the table inside the fuel filler flap. Further information on tire pressures can be obtained at a qualified specialist workshop.

## Tire and Loading Information placard

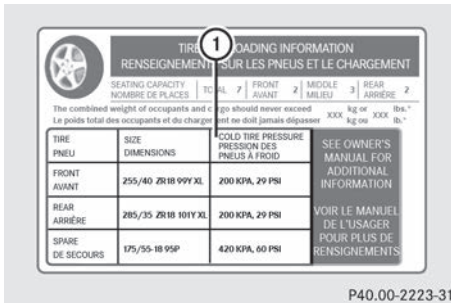

### 1 Recommended tire pressures

The Tire and Loading Information placard is on the B-pillar on the driver's side (▷ page 266). The Tire and Loading Information placard contains the recommended tire pressures for cold tires. The recommended tire pressures are valid for the maximum permissible load and up to the maximum permissible vehicle speed.

## Tire pressure table

The tire pressure table is on the inside of the fuel filler flap. It shows the tire pressure for all tires permitted at the factory for this vehicle; see illustration (example).

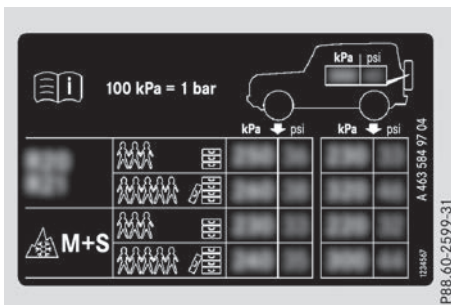

The tire pressure table contains the recommended pressures for cold tires for various operating conditions, i.e. differing load and speed conditions.

If a tire size precedes a tire pressure, the tire pressure information following is only valid for that tire size. The load conditions "partially laden" and "fully laden" are defined in the table for different numbers of occupants and amounts of luggage. The actual number of seats may differ.

Some tire pressure tables only show the rim diameter instead of the complete tire size, e.g. **R19**. The rim diameter is part of the tire size and can be found on the tire sidewall (▷ page 270). If the tire pressures have been set to the lower values for lighter loads and/or lower road speeds, the pressures should be reset to the higher values:

- if you want to drive with an increased load and/or
- if you want to drive at higher road speeds

The tire pressures for increased loads and/or higher road speeds, shown in the tire pressure table, may have a negative effect on driving comfort.

If the tire pressure is not set correctly, this can lead to an excessive build up of heat and a sudden loss of pressure.

For more information, contact a qualified specialist workshop.

## Important notes on tire pressure

### ⚠ WARNING

If the tire pressure drops repeatedly, the wheel, valve or tire may be damaged. Tire pressure that is too low may result in a tire blow-out. There is a risk of an accident.

- Check the tire for foreign objects.
- Check whether the wheel is losing air or the valve is leaking.

If you are unable to rectify the damage, contact a qualified specialist workshop.

### ⚠ WARNING

If you fit unsuitable accessories onto tire valves, the tire valves may be overloaded and malfunction, which can cause tire pressure loss. Due to their design, retrofitted tire pressure monitors keep the tire valve open. This can also result in tire pressure loss. There is a risk of an accident.

Only screw the standard valve cap or other valve caps approved by Mercedes-Benz for your vehicle onto the tire valve.

Use a suitable pressure gauge to check the tire pressure. The outer appearance of a tire does

not permit any reliable conclusion about the tire pressure. On vehicles equipped with the electronic tire pressure monitor, the tire pressure can be checked in the on-board computer.

The tire temperature and pressure increase when the vehicle is in motion. This is dependent on the driving speed and the load.

Therefore, you should only correct tire pressures when the tires are cold.

The tires are cold:

- if the vehicle has been parked without direct sunlight on the tires for at least three hours and
- if the vehicle has not been driven further than 1 mile (1.6 km)

The tire temperature changes depending on the outside temperature, the vehicle speed and the tire load. If the tire temperature changes by 18 °F (10 °C), the tire pressure changes by approximately 10 kPa (0.1 bar/1.5 psi). Take this into account when checking the pressure of warm tires. Only correct the tire pressure if it is too low for the current operating conditions. If you check the tire pressure when the tires are warm, the resulting value will be higher than if the tires were cold. This is normal. Do not reduce the tire pressure to the value specified for cold tires. The tire pressure would otherwise be too low.

Observe the recommended tire pressures for cold tires:

- on the Tire and Loading Information placard on the B-pillar on the driver's side
- in the tire pressure table in the fuel filler flap (▷ page 120)

### Underinflated or overinflated tires

#### Underinflated tires

##### WARNING

Tires with pressure that is too low can overheat and burst as a consequence. In addition, they also suffer from excessive and/or irregular wear, which can severely impair the braking properties and the driving characteristics. There is a risk of an accident.

Avoid tire pressures that are too low in all the tires, including the spare wheel.

Underinflated tires may:

- overheat, leading to tire defects
- adversely affect handling
- wear excessively and/or unevenly
- have an adverse effect on fuel consumption

#### Overinflated tires

##### WARNING

Tires with excessively high pressure can burst because they are damaged more easily by road debris, potholes etc. In addition, they also suffer from irregular wear, which can severely impair the braking properties and the driving characteristics. There is a risk of an accident.

Avoid tire pressures that are too high in all the tires, including the spare wheel.

Overinflated tires may:

- increase the braking distance
- adversely affect handling
- wear excessively and/or unevenly
- have an adverse effect on ride comfort
- be more likely to become damaged

#### Maximum tire pressures



- ① Example: maximum permissible tire pressure

Never exceed the maximum permissible tire inflation pressure. Always observe the recommended tire pressure for your vehicle when adjusting the tire pressure (▷ page 274).

-  The actual values for tires are vehicle-specific and may deviate from the values in the illustration.



## Checking the tire pressures

### Important safety notes

Observe the notes on tire pressure (▷ page 260).

Information on air pressure for the tires on your vehicle can be found:

- on the vehicle's Tire and Loading Information placard on the B-pillar
- in the tire pressure table in the fuel filler flap (▷ page 120)
- under "Tire pressure" (▷ page 260)

### Checking tire pressures manually

To determine and set the correct tire pressure, proceed as follows:

- ▶ Remove the valve cap of the tire that is to be checked.
- ▶ Press the tire pressure gage securely onto the valve.
- ▶ Read the tire pressure and compare it to the recommended value on the Tire and Loading Information placard or the tire pressure table (▷ page 260).
- ▶ If the tire pressure is too low, increase the tire pressure to the recommended value.
- ▶ If the tire pressure is too high, release air. To do so, press down the metal pin in the valve, using the tip of a pen for example. Then check the tire pressure again using the tire pressure checker.
- ▶ Screw the valve cap onto the valve.
- ▶ Repeat these steps for the other tires.

## Tire pressure monitor

### General notes

If a tire pressure monitor is installed, the vehicle's wheels have sensors that monitor the tire pressures in all four tires. The tire pressure monitor warns you if the pressure drops in one or more of the tires. The tire pressure monitor only functions if the corresponding sensors are installed in all wheels.

Information on tire pressures is displayed in the multifunction display. After a few minutes of driving, the current tire pressure of each wheel is shown in the [Serv.](#) menu.

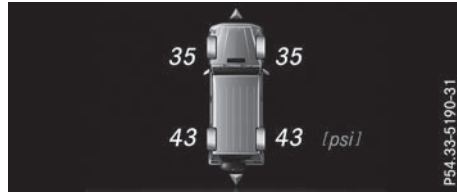

Information on the message display can be found in the "Checking the tire pressure electronically" section (▷ page 264).

### Important safety notes

#### WARNING

Each tire, including the spare (if provided), should be checked at least once a month when cold and inflated to the pressure recommended by the vehicle manufacturer on the Tire and Loading Information placard on the driver's door B-pillar or the tire pressure label on the inside of the fuel filler flap. If your vehicle has tires of a different size than the size indicated on the Tire and Loading Information placard or the tire pressure label, you should determine the proper tire pressure for those tires.

As an added safety feature, your vehicle has been equipped with a tire pressure monitoring system (TPMS) that illuminates a low tire pressure telltale when one or more of your tires are significantly underinflated. Accordingly, when the low tire pressure telltale illuminates, you should stop and check your tires as soon as possible, and inflate them to the proper pressure. Driving on a significantly underinflated tire causes the tire to overheat and can lead to tire failure. Underinflation also reduces fuel efficiency and tire tread life, and may affect the vehicle's handling and stopping ability.

Please note that the TPMS is not a substitute for proper tire maintenance, and it is the driver's responsibility to maintain correct tire pressure, even if underinflation has not reached the level to trigger illumination of the TPMS low tire pressure telltale.

USA only:

Your vehicle has also been equipped with a TPMS malfunction indicator to indicate if the system is not operating properly. The TPMS malfunction indicator is combined with the low tire pressure telltale. When the system detects a malfunction, the warning lamp will flash for approximately a minute and then remain continuously illuminated. This sequence will be repeated every time the vehicle is started as long as the malfunction exists.

When the malfunction indicator is illuminated, the system may not be able to detect or signal low tire pressure as intended. TPMS malfunctions may occur for a variety of reasons, including the mounting of incompatible replacement or alternate tires or wheels on the vehicle that prevent the TPMS from functioning properly. Always check the TPMS malfunction telltale after replacing one or more tires or wheels on your vehicle to ensure that the replacement or alternate tires and wheels allow the TPMS to continue to function properly.



It is the driver's responsibility to set the tire pressure to that recommended for cold tires which is suitable for the operating situation (▷ page 260). Note that the correct tire pressure for the current operating situation must first be taught-in to the tire pressure monitor. If a substantial loss of pressure occurs, the warning threshold for the warning message is aligned to the taught-in reference values. Restart the tire pressure monitor after adjusting the pressure of the cold tires (▷ page 265). The current pressures are saved as new reference values. As a result, a warning message will appear if the tire pressure drops significantly.

The tire pressure monitor does not warn you of an incorrectly set tire pressure. Observe the notes on the recommended tire pressure (▷ page 260).



The tire pressure monitor is not able to warn you of a sudden loss of pressure, e.g. if the tire is penetrated by a foreign object. In the event of a sudden loss of pressure, bring the vehicle to a halt by braking carefully. Avoid abrupt steering movements.

The tire pressure monitor has a yellow  warning lamp on the instrument cluster for indi-

cating a pressure loss or malfunction. The way that the warning lamp flashes or lights up indicates whether a tire pressure is too low or whether the tire pressure monitor is malfunctioning:

- if the  warning lamp is lit continuously, the tire pressure in one or more tires is significantly too low. The tire pressure monitor is not malfunctioning.
- if the  warning lamp flashes for around a minute and then remains lit constantly, the tire pressure monitor is malfunctioning.







In addition to the  warning lamp, a message appears in the multifunction display. Observe the information on display messages (▷ page 187).

It may take up to ten minutes for a malfunction of the tire pressure monitor to be indicated. The malfunction is indicated first by the  tire pressure warning lamp flashing for approximately one minute and then remaining lit. If the malfunction has been rectified, the  tire pressure warning lamp goes out after driving for a few minutes.

The tire pressure values indicated by the on-board computer may differ from those measured at a gas station with a pressure gauge. The tire pressures shown by the on-board computer refer to those measured at sea level. At high altitudes, the tire pressure values indicated by a pressure gauge are higher than those shown by the on-board computer. In this case, do not reduce the tire pressures.

The operation of the tire pressure monitor can be affected by interference from radio transmitting equipment (e.g. radio headphones, two-way radios) that may be being operated in or near the vehicle.

### Checking the tire pressure electronically

- ▶ Ensure that the SmartKey is in position  in the ignition lock.
- ▶ Press the  or  button on the steering wheel to select the **Serv.** menu.
- ▶ Press the  or  button to select **Tire Pressure**.
- ▶ Press the  button.  
The multifunction display shows the current tire pressure of each wheel.

If the vehicle has been parked for over 20 minutes, the **Tire pressure will be**

displayed after driving a few minutes message appears.

After a teach-in process, the tire pressure monitor automatically detects new wheels or new sensors. As long as a clear allocation of the tire pressure value to the individual wheels is not possible, the **Tire Pressure Monitor Active** display message is shown instead of the tire pressure display. The tire pressures are already being monitored.

If a spare wheel is installed, the system may continue to show the tire pressure of the wheel that has been removed for a few minutes. Please note that in this case, the value displayed for the replaced wheel does not indicate the current tire pressure of the spare wheel.

### Tire pressure monitor warning messages

If the tire pressure monitor detects a pressure loss in one or more tires, a warning message is shown in the multifunction display. The yellow  tire pressure warning lamp then lights up.

- If the **Correct Tire Pressure** message appears in the multifunction display, the tire pressure in at least one tire is too low. The tire pressure must be corrected when the opportunity arises.
- If the **Check Tires** message appears in the multifunction display, the tire pressure in at least one tire has dropped significantly. The tires must be checked.
- If the **Caution - Tire Malfunc.** message appears in the multifunction display, the tire pressure in at least one tire has dropped suddenly. The tires must be checked.

Be sure to observe the instructions and safety notes in the display messages in the "Tires" section (▷ page 187).

If the position of the wheels on the vehicle is changed, the tire pressure may be displayed in the wrong positions for a short time. This is rectified after a few minutes of driving, and the tire pressures are displayed for the correct positions.

### Restarting the tire pressure monitor

When you restart the tire pressure monitor, all existing warning messages are deleted and the  warning lamp goes out. The monitor uses the currently set tire pressures as the reference values for monitoring. In most cases, the tire

pressure monitor will automatically detect the new reference values after you have changed the tire pressure. However, you can also set reference values manually as described here. The tire pressure monitor then monitors the new tire pressure values.

- ▶ Set the tire pressure to the value recommended for the corresponding driving situation on the Tire and Loading Information placard on the B-pillar on the driver's side.

You can find more tire pressures for various operating conditions in the tire pressure table inside the filler flap.

Observe the information on tire pressure when doing so (▷ page 260).

- ▶ Make sure that the tire pressure is correct on all four wheels.
- ▶ Ensure that the SmartKey is in position  in the ignition lock.

- ▶ Press the  or  button on the steering wheel to select the **Serv.** menu.

- ▶ Press the  or  button to select **Tire Pressure**.

- ▶ Press the  button.

The multifunction display shows the current tire pressure for each tire or the **Tire pressure will be displayed after driving a few minutes** message appears.

- ▶ Press the  button. The **Use Current Pressures as New Reference Values** message appears in the multifunction display.

#### If you wish to confirm the restart:

- ▶ Press the  button. The **Tire Press. Monitor Restarted** message appears in the multifunction display.

After driving for a few minutes, the system checks whether the current tire pressures are within the specified range. The new tire pressures are then accepted as reference values and monitored.

#### If you wish to cancel the restart:

- ▶ Press the  button. The tire pressure values stored at the last restart will continue to be monitored.

### Radio type approval for the tire pressure monitor

Country	Radio type approval number
USA	FCC ID: MRXGG4 FCC ID: MRXMC34MA4
Canada	IC: 2546A-GG4

### Loading the vehicle

#### Instruction labels for tires and loads

#### WARNING

Overloaded tires can overheat, causing a blowout. Overloaded tires can also impair the steering and driving characteristics and lead to brake failure. There is a risk of accident.

Observe the load rating of the tires. The load rating must be at least half of the GAWR of your vehicle. Never overload the tires by exceeding the maximum load.

Two instruction labels on your vehicle show the maximum possible load.

- (1) The Tire and Loading Information placard is on the B-pillar on the driver's side. The Tire and Loading Information placard shows the maximum permissible number of occupants and the maximum permissible vehicle load. It also contains details of the tire sizes and corresponding pressures for tires mounted at the factory.
- (2) The vehicle identification plate is on the B-pillar on the driver's side. The vehicle identification plate informs you of the gross vehicle weight rating. It is made up of the vehicle weight, all vehicle occupants, the fuel and the cargo. You can also find information about the maximum gross axle weight rating on the front and rear axle. The maximum gross axle weight rating is the maximum weight that can be carried by one axle (front or rear axle). Do not exceed the maximum gross vehicle weight or the maximum gross axle weight rating for the front or rear axle.



① B-pillar, driver's side

#### Maximum permissible gross mass

TIRE RENSEIGNEMENTS		LOADING INFORMATION			
RENSEIGNEMENTS SUR LES PNEUS ET LE CHARGEMENT		TOTAL	FRONT	MIDDLE	REAR
		AVANT	MILIEU	ARRIERE	
SEATING CAPACITY NOMBRE DE PLACES	TOTAL	7	2	3	2
The combined weight of occupants and cargo should never exceed Le poids total des occupants et du chargement ne doit jamais dépasser					
		XXX kg or		XXX lbs.*	
TIRE PNEU	SIZE DIMENSIONS	COLD TIRE PRESSURE PRESSION DES PNEUS À FROID			
FRONT AVANT	255/40 ZR18 99F XL	200 KPA, 29 PSI			
REAR ARRIERE	285/35 ZR18 101F XL	200 KPA, 29 PSI			
SPARE DE SECOURS	175/55-18 95P	420 KPA, 60 PSI			
					SEE OWNER'S MANUAL FOR ADDITIONAL INFORMATION
					VOIR LE MANUEL DE L'USAGER POUR PLUS DE RENSEIGNEMENTS

P40.00-2224-31

- Specification for maximum permissible load ① is listed on the Tire and Loading Information placard: "The combined weight of occupants and cargo should never exceed XXX kilograms or XXX lbs."

The gross weight of all vehicle occupants, cargo, luggage and trailer load/noseweight (if applicable) must not exceed the specified value.

- i** The specifications shown on the Tire and Loading Information placard in the illustration are examples. The maximum permissible load is vehicle-specific and may deviate from the data shown here. The maximum permissible load that applies for your vehicle can be found on your vehicle's Tire and Loading Information placard.

**Number of seats**

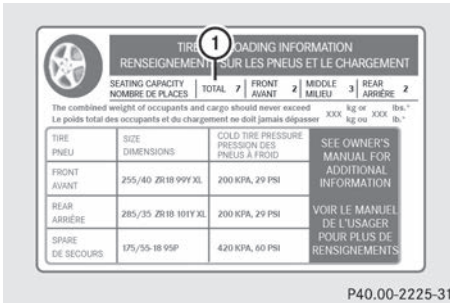

Maximum number of seats ① indicates the maximum number of occupants allowed to travel in the vehicle. This information can be found on the Tire and Loading Information placard.

**i** The specifications shown on the Tire and Loading Information placard in the illustration are examples. The number of seats is vehicle-specific and can differ from the details shown. The number of seats in your vehicle can be found on the Tire and Loading Information placard.

**Determining the correct load limit**

**Step-by-step instructions**

The following steps have been developed as required of all manufacturers under Title 49,

**Example: steps 1 to 3**

The following table shows examples on how to calculate total and cargo load capacities with varying seating configurations and number and size of occupants. The following examples use a maximum load of 1,500 lbs (680 kg). **This is for illustration purposes only.** Make sure you are using the actual load limit for your vehicle stated on your vehicle's Tire and Loading Information placard (▷ page 266).

The greater the combined weight of the occupants, the lower the maximum luggage load. Observe the additional information when towing a trailer (▷ page 154).

**Step 1**

	Example 1	Example 2	Example 3
<b>Combined maximum weight of occupants and load (data from the Tire and Loading Information placard)</b>	1500 lbs (680 kg)	1500 lbs (680 kg)	1500 lbs (680 kg)

Code of U.S. Federal Regulations, Part 575 pursuant to the "National Traffic and Motor Vehicle Safety Act of 1966".

- ▶ **Step 1:** Locate the statement "The combined weight of occupants and cargo should never exceed XXX kg or XXX lbs." on your vehicle's Tire and Loading Information placard.
- ▶ **Step 2:** Determine the combined weight of the driver and passengers that will be riding in your vehicle.
- ▶ **Step 3:** Subtract the combined weight of the driver and passengers from XXX kilograms or XXX lbs.
- ▶ **Step 4:** The resulting figure equals the available amount of cargo and luggage load capacity. Example: if the "XXX" amount equals 1400 lbs and there will be five 150 lbs passengers in your vehicle, the amount of available cargo and luggage load capacity is 650 lbs (1400 - 750 (5 x 150) = 650 lbs).
- ▶ **Step 5:** Determine the combined weight of luggage and cargo being loaded on the vehicle. That weight may not safely exceed the available cargo and luggage load capacity calculated in step 4.

## Step 2

	Example 1	Example 2	Example 3
<b>Number of people in the vehicle (driver and occupants)</b>	5	3	1
<b>Distribution of the occupants</b>	Front: 2 Rear: 3	Front: 1 Rear: 2	Front: 1
<b>Weight of the occupants</b>	Occupant 1: 150 lbs (68 kg) Occupant 2: 180 lbs (82 kg) Occupant 3: 160 lbs (73 kg) Occupant 4: 140 lbs (63 kg) Occupant 5: 120 lbs (54 kg)	Occupant 1: 200 lbs (91 kg) Occupant 2: 190 lbs (86 kg) Occupant 3: 150 lbs (68 kg)	Occupant 1: 150 lbs (68 kg)
<b>Gross weight of all occupants</b>	750 lbs (340 kg)	540 lbs (245 kg)	150 lbs (68 kg)

## Step 3

	Example 1	Example 2	Example 3
<b>Permissible load (maximum gross vehicle weight rating from the Tire and Loading Information placard minus the gross weight of all occupants)</b>	1500 lbs (680 kg) - 750 lbs (340 kg) = 750 lbs (340 kg)	1500 lbs (680 kg) - 540 lbs (245 kg) = 960 lbs (435 kg)	1500 lbs (680 kg) - 150 lbs (68 kg) = 1350 lbs (612 kg)

**Vehicle identification plate**

Even if you have calculated the total load carefully, you should still make sure that the gross vehicle weight rating and the gross axle weight rating are not exceeded. Details can be found on the vehicle identification plate on the B-pillar on the driver's side of the vehicle (> page 266).

**Gross vehicle weight rating:** the gross weight of the vehicle, all passengers, load and trailer load/noseweight (if applicable) must not exceed the gross vehicle weight rating.

**Gross Axle Weight Rating (GAWR):** the maximum permissible load that can be carried by one axle (front or rear axle).

To ensure that your vehicle does not exceed the maximum permissible values (gross vehicle

weight and maximum gross axle weight rating), have your loaded vehicle (including driver, occupants, load and full trailer load if applicable) weighed on a suitable vehicle weighbridge.

## All about wheels and tires

### Uniform Tire Quality Grading Standards

#### Overview of Tire Quality Grading Standards

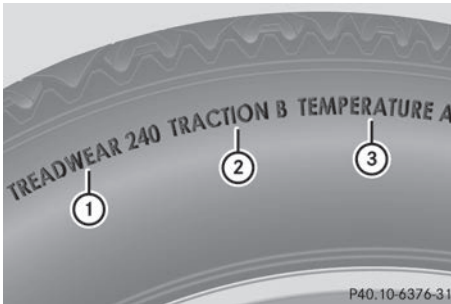

Uniform Tire Quality Grading Standards are U.S. government specifications. Their purpose is to provide drivers with uniform reliable information on tire performance data. Tire manufacturers have to grade tires using three performance factors: ① tread wear grade, ② traction grade and ③ temperature grade. These regulations do not apply to Canada. Nevertheless, all tires sold in North America are provided with the corresponding quality grading markings on the sidewall of the tire.

Quality grades can be found, where applicable, on the tire sidewall between tread shoulder and maximum section width.

Example:

- **Treadwear grade:** 200
- **Traction grade:** AA
- **Temperature grade:** A

All passenger car tires must conform to the statutory safety requirements in addition to these grades.

- ❗ The actual values for tires are vehicle-specific and may deviate from the values in the illustration.

#### Treadwear

The treadwear grade is a comparative rating based on the wear rate of the tire when tested under controlled conditions on a specified U.S. government course. For example, a tire graded

150 would wear one and one-half times as well on the government course as a tire graded 100.

The relative performance of tires depends upon the actual conditions of their use, however, and may depart significantly from the norm due to variations in driving habits, service practices and differences in road characteristics and climate.

#### Traction

##### ⚠ WARNING

The traction grade assigned to this tire is based on straight-ahead braking traction tests, and does not include acceleration, cornering, hydroplaning, or peak traction characteristics.

- ❗ Avoid wheelspin. This can lead to damage to the drive train.

The traction grades – from highest to lowest – are AA, A, B and C. Those grades represent the tire's ability to stop on wet pavement as measured under controlled conditions on specified government test surfaces of asphalt and concrete. A tire marked C may have poor traction performance.

The safe speed on a wet, snow covered or icy road is always lower than on dry road surfaces. You should pay special attention to road conditions when temperatures are around freezing point.

Mercedes-Benz recommends a minimum tread depth of  $\frac{1}{8}$  in (4 mm) on all four winter tires. Observe the legally required minimum tire tread depth (> page 258). Winter tires can reduce the braking distance on snow-covered surfaces in comparison with summer tires. The braking distance is still much further than on surfaces that are not icy or covered with snow. Take appropriate care when driving.

Further information on winter tires (M+S tires) (> page 259).

#### Temperature

##### ⚠ WARNING

The temperature grade for this tire is established for a tire that is properly inflated and not overloaded. Excessive speed, underinflation, or excessive loading, either separately or

in combination, can cause excessive heat build-up and possible tire failure.

The temperature grades are A (the highest), B, and C, representing the tire's resistance to the generation of heat and its ability to dissipate heat when tested under controlled conditions on a specified indoor laboratory test wheel. Sustained high temperature can cause the material of the tire to degenerate and reduce tire life, and excessive temperature can lead to sudden tire failure. The grade C corresponds to a level of performance which all passenger car tires must meet under the Federal Motor Vehicle Safety Standard No. 109. Grades B and A represent higher levels of performance on the laboratory test wheel than the minimum required by law.

### Tire labeling

#### Overview of tire labeling

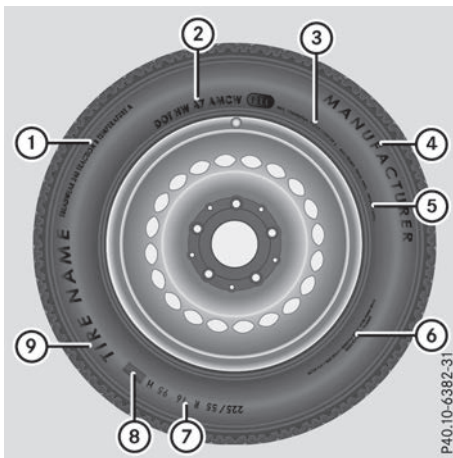

- ① Uniform Tire Quality Grading Standard (▷ page 273)
- ② DOT, Tire Identification Number (▷ page 272)
- ③ Maximum tire load (▷ page 272)
- ④ Manufacturer
- ⑤ Maximum tire pressure (▷ page 262)
- ⑥ Tire material (▷ page 273)
- ⑦ Tire size designation, load-bearing capacity and speed rating (▷ page 270)
- ⑧ Load index (▷ page 272)
- ⑨ Tire name

The markings described above are on the tire in addition to the tire name (sales designation) and the manufacturer's name.

- ❗ Tire data is vehicle-specific and may deviate from the data in the example.

#### Tire size designation, load-bearing capacity and speed rating

##### ⚠ WARNING

Exceeding the stated tire load-bearing capacity and the approved maximum speed could lead to tire damage or the tire bursting. There is a risk of accident.

Therefore, only use tire types and sizes approved for your vehicle model. Observe the tire load rating and speed rating required for your vehicle.

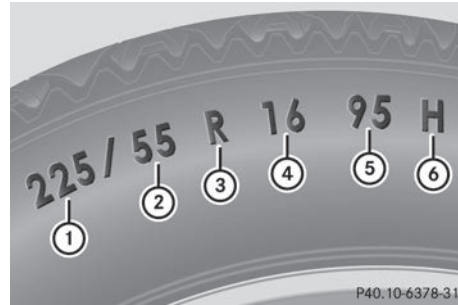

- ① Tire width
- ② Height-width ratio in percentage
- ③ Tire code
- ④ Rim diameter
- ⑤ Load bearing index
- ⑥ Speed rating

**General:** depending on the manufacturer's standards, a letter is imprinted into the tire wall before the size description.

If there is no letter preceding the size description (as shown above): these are passenger vehicle tires according to European manufacturing standards.

If "P" precedes the size description: passenger vehicle tires according to U.S. manufacturing standards.

If "P" precedes the size description: light truck tires according to U.S. manufacturing standards.



If "T" precedes the size description: these are compact emergency spare wheels at high tire pressure, to be used only temporarily in an emergency.

**Tire width:** tire width ① shows the nominal tire width in millimeters.

**Height-width ratio:** height-width ratio ② is the ratio between tire height and tire width. The aspect ratio is calculated by dividing the tire width by the tire height. The resulting quotient is given as a percentage.

**Tire code:** tire code ③ shows the tire type. "R" represents radial tires; "D" represents diagonal tires; "B" represents diagonal radial tires.

Optionally, tires with a maximum speed of over 149 mph (240 km/h) may have "ZR" in the size description, depending on the manufacturer (e.g. 245/40 ZR 18).

**Rim diameter:** rim diameter ④ is the diameter of the bead seat, not the diameter of the rim flange. The rim diameter is specified in inches (in).

**The load-bearing index:** load-bearing index ⑤ (also load index), is a code that contains the maximum load-bearing capacity of a tire.

Do not overload the tires by exceeding the specified load limit. The maximum permissible load can be found on the vehicle's Tire and Loading Information placard on the B-pillar on the driver's side (▷ page 266).

Example:

Load-bearing index 91 indicates a maximum load of 1,356 lb (615 kg) that the tires can bear. Further information on the maximum tire load in kilograms and pounds (▷ page 272).

For further information on the load bearing index, see "Load index" (▷ page 272).

**Speed rating:** speed rating ⑥ specifies the approved maximum speed of the tire.

**i** Tire data is vehicle-specific and may deviate from the data in the example.

Regardless of the speed rating, always observe the speed limits. Drive carefully and adapt your driving style to the traffic conditions.

**i** Since 2009, tires in Europe which correspond to the noise limitations of Directive ECE-R 117 show an >>S<< (Sound) mark. This marking is in accordance with the type approval number and is not connected to the speed rating.

### Summer tires

Index	Speed rating
Q	up to 100 mph (160 km/h)
R	up to 106 mph (170 km/h)
S	up to 112 mph (180 km/h)
T	up to 118 mph (190 km/h)
H	up to 130 mph (210 km/h)
V	up to 149 mph (240 km/h)
W	up to 168 mph (270 km/h)
Y	up to 186 mph (300 km/h)
ZR...Y	up to 186 mph (300 km/h)
ZR...(..Y)	over 186 mph (300 km/h)
ZR	over 149 mph (240 km/h)

- Optionally, tires with a maximum speed of over 149 mph (240 km/h) may have "ZR" in the size description, depending on the manufacturer (e.g. 245/40 ZR18).

The service specification is made up of load-bearing index ⑤ and speed rating ⑥.

- If the size description of your tire includes "ZR" and there are no service specifications, ask the tire manufacturer in order to find out the maximum speed.

If a service specification is available, the maximum speed is limited according to the speed rating in the service specification. Example: 245/40 ZR18 97 Y. In this example, "97 Y" is the service specification. The letter "Y" represents the speed rating and the maximum speed of the tire is limited to 186 mph (300 km/h).

- The size description for all tires with maximum speeds of over 186 mph (300 km/h) must include "ZR", **and** the service specification must be given in parentheses. Example: 275/40 ZR 18 (99 Y). Speed rating "(Y)" indicates that the maximum speed of the tire is over 186 mph (300 km/h). Ask the tire manufacturer about the maximum speed.

### All-weather tires and winter tires

Index	Speed rating
Q M+S <sup>1</sup>	up to 100 mph (160 km/h)
T M+S <sup>1</sup>	up to 118 mph (190 km/h)
H M+S <sup>1</sup>	up to 130 mph (210 km/h)
V M+S <sup>1</sup>	up to 149 mph (240 km/h)

**i** Not all tires with the M+S marking provide the driving characteristics of winter tires. In addition to the M+S marking, winter tires also have the  snowflake symbol on the tire wall. Tires with this marking fulfill the requirements of the Rubber Manufacturers Association (RMA) and the Rubber Association of Canada (RAC) regarding the tire traction on snow. They have been especially developed for driving on snow.

When the electronic speed limiter is set, your vehicle is prevented from exceeding 130 mph (210 km/h).

The speed rating of tires mounted at the factory may be higher than the maximum speed that the electronic speed limiter permits.

Make sure that your tires have the required speed rating, e.g. when buying new tires. You can find information on this under "Tires" ([▷ page 279](#)).

Further information about reading tire data can be obtained from any qualified specialist workshop.

### Load index



In addition to the load bearing index, load index **1** may be imprinted after the letters that

<sup>1</sup> Or M+S  for winter tires.

identify speed index **6** on the sidewall of the tire ([▷ page 270](#)).

- If no specification is given: no text (as in the example above) indicates a standard-load tire (SL).
- XL or Extra Load: represents a reinforced tire
- Light Load: represents a light load tire
- C, D, E: represents a load range that depends on the maximum load that the tire can carry at a certain pressure

**i** Tire data is vehicle-specific and may deviate from the data in the example.

### Maximum load rating



Maximum tire load **1** is the maximum permissible weight for which the tire is approved.

Do not overload the tires by exceeding the specified load limit. The maximum permissible load can be found on the vehicle's Tire and Loading Information placard on the B-pillar on the driver's side ([▷ page 266](#)).

**i** The actual values for tires are vehicle-specific and may deviate from the values in the illustration.

### DOT, Tire Identification Number (TIN)

U.S. tire regulations stipulate that every tire manufacturer or retreader must imprint a TIN in or on the sidewall of each tire produced.

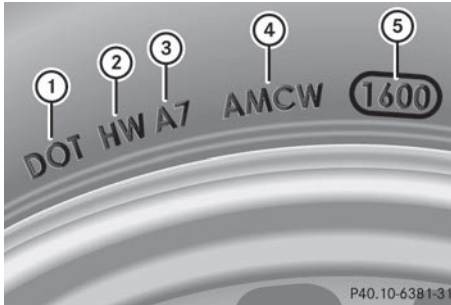

The TIN is a unique identification number. The TIN enables tire manufacturers to inform purchasers of recalls and other safety-relevant matters. It makes it possible for the purchaser to easily identify the affected tires.

The TIN is made up of manufacturer identification code ②, tire size ③, tire type code ④ and manufacturing date ⑤.

**DOT (Department of Transportation):** Tire symbol ① indicates that the tire complies with the requirements of the U.S. Department of Transportation.

**Manufacturer identification code:** manufacturer identification code ② provides details on the tire manufacturer. New tires have a code with two symbols. Retreaded tires have a code with four symbols.

For further information about retreaded tires, see (> page 279).

**Tire size:** identifier ③ describes the tire size.

**Tire type code:** Tire type code ④ can be used by the manufacturer as a code to describe specific characteristics of the tire.

**Date of manufacture:** date of manufacture ⑤ provides information about the age of a tire. The first and second positions represent the week of manufacture, starting with "01" for the first calendar week. Positions three and four represent the year of manufacture. For example, a tire that is marked "3214" was manufactured in week 32 in 2014.

**i** Tire data is vehicle-specific and may deviate from the data in the example.

## Tire characteristics

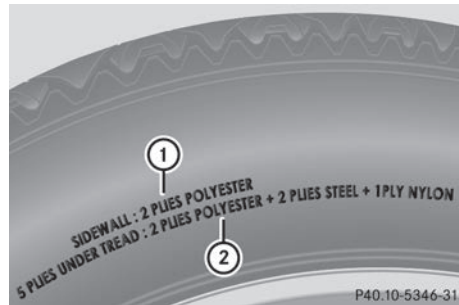

This information describes the type of tire cord and the number of layers in sidewall ① and under tire tread ②.

**i** Tire data is vehicle-specific and may deviate from the data in the example.

## Definition of terms for tires and loading

### Tire ply composition and material used

Describes the number of layers or the number of rubber-coated belts in the tread and the sidewall of the tire. These are made of steel, nylon, polyester and other materials.

### Bar

Metric unit for tire pressure. 14.5038 pounds per square inch (psi) and 100 kilopascals (kPa) are the equivalent of 1 bar.

### DOT (Department of Transportation)

DOT-marked tires fulfill the requirements of the U S Department of Transportation.

### Normal occupant weight

The number of occupants for which the vehicle is designed multiplied by 68 kilograms (150 lbs).

### Uniform Tire Quality Grading Standards

A uniform standard to grade the quality of tires with regards to tread quality, tire traction and temperature characteristics. The quality grading assessment is made by the manufacturer following specifications from the U.S. government. The ratings are molded into the sidewall of the tire.

### Recommended tire pressures

The recommended tire pressure applies to the tires mounted at the factory.

The Tire and Loading Information placard contains the recommended tire pressures for cold tires on a fully loaded vehicle and for the maximum permissible vehicle speed.

The tire pressure table contains the recommended pressures for cold tires for various operating conditions, i.e. differing load and speed conditions.

### Increased vehicle weight due to optional equipment

The combined weight of all standard and optional equipment available for the vehicle, regardless of whether it is actually installed on the vehicle or not.

### Rim

This is the part of the wheel on which the tire is mounted.

### GAWR (Gross Axle Weight Rating)

The GAWR is the maximum gross axle weight rating. The actual load on an axle must never exceed the gross axle weight rating. The gross axle weight rating can be found on the vehicle identification plate on the B-pillar on the driver's side.

### Speed rating

The speed rating is part of the tire identification. It specifies the speed range for which the tire is approved.

### GTW (Gross Trailer Weight)

The GTW is the weight of a trailer including the weight of the load, luggage, accessories etc. on the trailer.

### GVW (Gross Vehicle Weight)

The gross vehicle weight includes the weight of the vehicle including fuel, tools, the spare wheel, accessories installed, occupants, luggage and the drawbar noseweight, if applicable. The gross vehicle weight must not exceed the gross vehicle weight rating GVWR as specified on the vehicle identification plate on the B-pillar on the driver's side.

### GVWR (Gross Vehicle Weight Rating)

The GVWR is the maximum permissible gross weight of a fully loaded vehicle (the weight of the vehicle including all accessories, occupants, fuel, luggage and the drawbar noseweight, if applicable). The gross vehicle weight rating is specified on the vehicle identification plate on the B-pillar on the driver's side.

### Maximum loaded vehicle weight

The maximum weight is the sum of:

- the curb weight of the vehicle
- the weight of the accessories
- the load limit
- the weight of the factory installed optional equipment

### Kilopascal (kPa)

Metric unit for tire pressure. 6.9 kPa corresponds to 1 psi. Another unit for tire pressure is bar. 100 kilopascals (kPa) are the equivalent of 1 bar.

### Load index

In addition to the load-bearing index, the load index may also be imprinted on the sidewall of the tire. This specifies the load-bearing capacity of the tire more precisely.

### Curb weight

The weight of a vehicle with standard equipment including the maximum capacity of fuel, oil and coolant. It also includes the air-conditioning system and optional equipment if these are installed in the vehicle, but does not include passengers or luggage.

### Maximum load rating

The maximum tire load is the maximum permissible weight in kilograms or lbs for which a tire is approved.

### Maximum permissible tire pressure

Maximum permissible tire pressure for one tire.

### Maximum load on one tire

Maximum load on one tire. This is calculated by dividing the maximum axle load of one axle by two.

**PSI (pounds per square inch)**

A standard unit of measure for tire pressure.

**Aspect ratio**

Relationship between tire height and tire width in percent.

**Tire pressure**

This is pressure inside the tire applying an outward force to each square inch of the tire's surface. The tire pressure is specified in pounds per square inch (psi), in kilopascals (kPa) or in bar. The tire pressure should only be corrected when the tires are cold.

**Cold tire pressure**

The tires are cold:

- if the vehicle has been parked with the tires out of direct sunlight for at least three hours and
- if the vehicle has not been driven further than 1 mile (1.6 km)

**Tread**

The part of the tire that comes into contact with the road.

**Bead**

The tire bead ensures that the tire sits securely on the wheel. There are several steel wires in the bead to prevent the tire from coming loose from the wheel rim.

**Sidewall**

The part of the tire between the tread and the bead.

**Weight of optional extras**

The combined weight of those optional extras that weigh more than the replaced standard parts and more than 2.3 kg (5 lbs). These optional extras, such as high-performance brakes, level control, a roof rack or a high-performance battery, are not included in the curb weight and the weight of the accessories.

**TIN (Tire Identification Number)**

This is a unique identifier which can be used by a tire manufacturer to identify tires, for example for a product recall, and thus identify the purchasers. The TIN is made up of the manufacturer's identity code, tire size, tire type code and the manufacturing date.

**Load bearing index**

The load bearing index (also load index) is a code that contains the maximum load bearing capacity of a tire.

**Traction**

Traction is the result of friction between the tires and the road surface.

**TWR (Tongue Weight Rating)**

The TWR specifies the maximum permissible weight that the ball coupling of the trailer tow hitch can support.

**Treadwear indicators**

Narrow bars (tread wear bars) that are distributed over the tire tread. If the tire tread is level with the bars, the wear limit of  $\frac{1}{16}$  in (1.6 mm) has been reached.

**Occupant distribution**

The distribution of occupants in a vehicle at their designated seating positions.

**Total load limit**

Nominal load and luggage load plus 68 kg (150 lbs) multiplied by the number of seats in the vehicle.

**Changing a wheel****Flat tire**

You can find information on what to do in the event of a flat tire in the "Breakdown assistance" section (▷ page 246).

**Rotating the wheels****⚠ WARNING**

Interchanging the front and rear wheels may severely impair the driving characteristics if the wheels or tires have different dimensions. The wheel brakes or suspension components may also be damaged. There is a risk of accident.

Rotate front and rear wheels only if the wheels and tires are of the same dimensions.

**!** On vehicles equipped with a tire pressure monitor, electronic components are located in the wheel.

Tire-mounting tools should not be used near the valve. This could damage the electronic components.

Only have tires changed at a qualified specialist workshop.

Always observe the instructions and safety notes under "Installing a wheel" (▷ page 276).

The wear patterns on the front and rear tires differ, depending on the operating conditions. Rotate the wheels before a clear wear pattern has formed on the tires. Front tires typically wear more on the shoulders and the rear tires in the center.

On vehicles that have the same size front and rear wheels, you can rotate the wheels according to the intervals in the tire manufacturer's warranty book in your vehicle documents. If no warranty book is available, the tires should be rotated every 3,000 to 6,000 miles (5,000 to 10,000 km). Depending on tire wear, this may be required earlier. Do not change the direction of wheel rotation.

Clean the contact surfaces of the wheel and the brake disc thoroughly every time a wheel is rotated. Check the tire pressure and reactivate the tire pressure monitor if necessary (▷ page 265).

### Direction of rotation

Tires with a specified direction of rotation have additional benefits, e.g. if there is a risk of hydroplaning. You will only gain these benefits if the correct direction of rotation is observed.

An arrow on the sidewall of the tire indicates its correct direction of rotation.

You may mount the spare wheel against the direction of rotation. Adhere to the time restriction on use as well as the speed limitation specified on the spare wheel.

### Storing wheels

Store tires that are not being used in a cool, dry and preferably dark place. Protect the tires from oil, grease, gasoline and diesel.

## Mounting a wheel

### Preparing the vehicle

#### WARNING

When you remove the spare wheel from the spare wheel bracket, the vehicle's weight distribution changes. If the vehicle is already raised, the jack could tip over. There is a risk of injury.

Remove the spare wheel from the spare wheel bracket before lifting the vehicle.

- ▶ Stop the vehicle on solid, non-slippery and level ground.
- ▶ Apply the parking brake.
- ▶ Bring the front wheels into the straight-ahead position.
- ▶ Shift the automatic transmission to position **P**.
- ▶ Switch off the engine.
- ▶ Remove the vehicle tools and jack from the vehicle (▷ page 244).
- ▶ Remove the spare wheel from the spare wheel bracket (▷ page 245).
- ▶ Safeguard the vehicle against rolling away.

### Securing the vehicle to prevent it from rolling away

- ▶ Place chocks or other suitable items under the front and rear of the wheel that is diagonally opposite the wheel you wish to change.

### Raising the vehicle

#### WARNING

If you do not position the jack correctly at the appropriate jacking point of the vehicle, the jack could tip over with the vehicle raised. There is a risk of injury.

Only position the jack at the appropriate jacking point of the vehicle. The base of the jack must be positioned vertically, directly under the jacking point of the vehicle.

- !** Only position the jack at the appropriate jacking point of the vehicle. Otherwise, you could damage the vehicle.

**Observe the following when raising the vehicle:**

- To raise the vehicle, only use the vehicle-specific jack that has been tested and approved by Mercedes-Benz. If used incorrectly, the jack could tip over with the vehicle raised.
- The jack is designed only to raise and hold the vehicle for a short time while a wheel is being changed. It must not be used for performing maintenance work under the vehicle.
- Avoid changing the wheel on uphill and downhill slopes.
- Before raising the vehicle, secure it from rolling away by applying the parking brake and inserting wheel chocks. Do not disengage the parking brake while the vehicle is raised.
- The jack must be placed on a firm, flat and non-slip surface. On a loose surface, a large, flat, load-bearing underlay must be used. On a slippery surface, a non-slip underlay must be used, e.g. rubber mats.
- Do not use wooden blocks or similar objects as a jack underlay. Otherwise, the jack will not be able to achieve its load-bearing capacity due to the restricted height.
- Make sure that the distance between the underside of the tires and the ground does not exceed 1.2 in (3 cm).
- Do not place your hands or feet under the raised vehicle.
- Do not lie under the vehicle.
- Do not start the engine when the vehicle is raised.
- Do not open or close a door when the vehicle is raised.
- Make sure that no persons are present in the vehicle when the vehicle is raised.



- ▶ Using lug wrench ①, loosen the bolts on the wheel you wish to change by about one full turn. Do not unscrew the bolts completely.

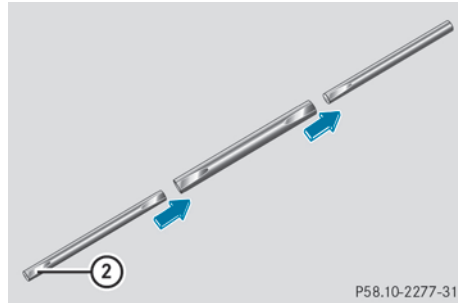

- ▶ Assemble the pump lever for the jack from the vehicle tool kit.

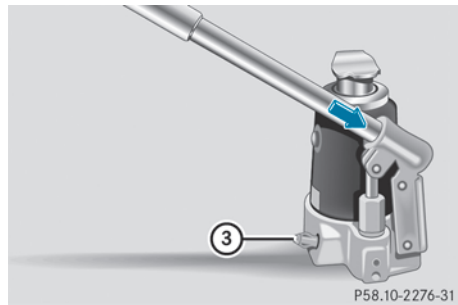

- ▶ Turn lowering screw ③ on the jack clockwise as far as it will go using notch ② on the pump lever. Pressure release screw ③ is closed.

- ▶ **i** Do not turn pressure release screw ③ by more than one to two revolutions. Otherwise, hydraulic fluid could escape.

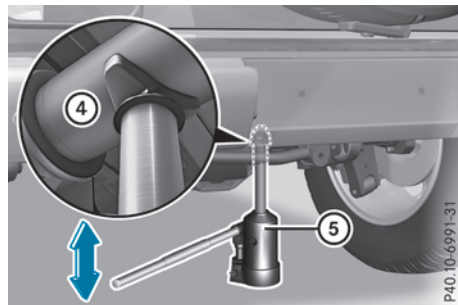

- ▶ Position jack ⑤ vertically under the jacking point of axle carrier tube ④.

Make sure that jack ⑤ is at the correct position under axle carrier tube ④. The front or rear axle must sit securely in the recess of jack ⑤.

- ▶ Keep pumping until axle carrier tube ④ sits securely in the recess of jack ⑤ and the base of the jack lies evenly on the ground. Ensure that the jack is located vertically under the jacking point.
- ▶ Raise the vehicle by pumping until the tire is no more than 1.2 in (3 cm) off the ground.

### Removing a wheel

**!** Do not place wheel bolts in sand or on a dirty surface. The bolt and wheel hub threads could otherwise be damaged when you screw them in.

When mounting/removing wheels, and for as long as the wheels are removed, avoid applying any external force on the brake disks. This could impair the level of comfort when braking.

- ▶ Unscrew the wheel bolts.
- ▶ Remove the wheel.

### Mounting a new wheel

#### **!** WARNING

Oiled or greased wheel bolts/wheel nuts and damaged wheel bolt/wheel nut/wheel hub threads can cause wheel bolts/wheel nuts to come loose. As a result, you could lose a wheel while driving. There is a risk of an accident.

Never oil or grease wheel bolts/wheel nuts. In the event of damage to the threads, contact a qualified specialist workshop immediately. Have the damaged wheel bolts/wheel nuts or hub threads replaced/renewed. Do not continue driving.

#### **!** WARNING

If you tighten the wheel bolts or wheel nuts when the vehicle is raised, the jack could tip over. There is a risk of injury.

Only tighten the wheel bolts or wheel nuts when the vehicle is on the ground.

**!** To prevent damage to the paintwork, hold the wheel securely against the wheel hub while screwing in the first wheel bolt.

Always pay attention to the instructions and safety notes in the "Changing a wheel" section (▷ page 275).

Only use wheel bolts that have been designed for the wheel and the vehicle. For safety reasons, Mercedes-Benz recommends that you only use wheel bolts which have been approved for Mercedes-Benz vehicles and the respective wheel.

- ▶ Clean the wheel and wheel hub contact surfaces.
- ▶ Place the new wheel on the wheel hub and push it on.
- ▶ Tighten the wheel bolts until they are finger-tight.

### Lowering the vehicle

#### **!** WARNING

The wheels could work loose if the wheel nuts and bolts are not tightened to the specified tightening torque. There is a risk of accident. Have the tightening torque immediately checked at a qualified specialist workshop after a wheel is changed.

- ▶ Slowly open the pressure release screw on the jack using the pump lever by approximately one full turn and carefully lower the vehicle (▷ page 276).
- ▶ You can put the jack aside.

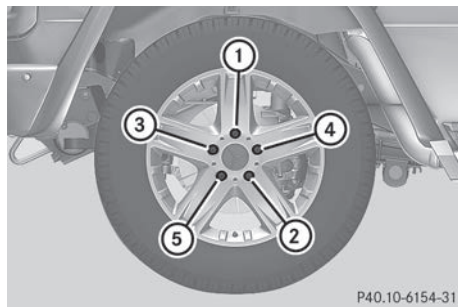

P40.10-6154-31

- ▶ Tighten the wheel bolts evenly in a crosswise pattern in the sequence indicated (① to ⑤).



The tightening torque must be **96 lb-ft (130 Nm)**.

- ▶ Dismantle the pump lever.
- ▶ Push the jack piston back in and close the drain plug.
- ▶ Use the nuts to secure the faulty wheel to the spare wheel bracket (▷ page 245).
- ▶ Stow the jack and the vehicle tools in the vehicle again.
- ▶ Check the tire pressure of the newly installed wheel and adjust it if necessary.  
Observe the recommended tire pressure (▷ page 260).

If you are driving with the emergency spare wheel installed, the tire pressure monitor cannot function reliably. Only restart the tire pressure monitor when the defective wheel has been replaced with a new wheel.

All mounted wheels must be equipped with functioning sensors for the tire pressure monitor.

### Wheel and tire combinations

You can ask for information regarding permitted wheel/tire combinations at an authorized Mercedes-Benz Center.

**!** For safety reasons, Mercedes-Benz recommends that you only use tires, wheels and accessories which have been specifically approved by Mercedes-Benz for your vehicle. These are specially adapted to the various driving safety systems, such as ABS or ESP®. Only use tires, wheels and accessories tested and recommended by Mercedes-Benz. Certain characteristics, such as handling, vehicle noise emissions, fuel consumption, etc. may otherwise be adversely affected. In addition, other wheel sizes may cause the tires to rub against the vehicle body and axle components, when under load. This may result in damage to the tire or to the vehicle. Mercedes-Benz is not responsible for any damage caused by using tires, wheels or accessories different from those recommended.

Information on tires, wheels and permissible combinations can be obtained at a qualified specialist workshop.

**!** Retreaded tires are neither tested nor recommended by Mercedes-Benz, since previ-

ous damage cannot always be detected on retreaded tires. As a result, Mercedes-Benz cannot guarantee vehicle safety if retreaded tires are mounted. Do not mount used tires if you have no information about their previous usage.

The recommended pressures for various operating conditions can be found:

- on the Tire and Loading Information placard on the B-pillar on the driver's side
- in the tire pressure table in the fuel filler flap

Observe the notes on recommended tire pressures under various operating conditions (▷ page 260).

Check tire pressures regularly, and only when the tires are cold. Comply with the maintenance recommendations of the tire manufacturer in the vehicle document wallet.

Notes on equipping the vehicle:

- always install tires of the same size on one axle (left/right)
- always install the same type of tires on your vehicle (summer tires, winter tires, all-weather tires, all-terrain tires)

### Spare wheel

If the tire and wheel dimensions of the spare wheel differ from the wheel to be replaced, the spare wheel is an emergency spare wheel.

#### WARNING

Wheel and tire dimensions as well as the type of tire can vary between the spare wheel and the wheel to be replaced. When the spare wheel is mounted, driving characteristics may be severely affected. There is a risk of an accident.

In order to reduce risks:

- you should therefore adapt your driving style and drive carefully.
- never mount more than one spare wheel that differs from the wheel to be replaced.
- only use a spare wheel that differs from the wheel to be replaced for a short time.

- do not deactivate ESP®.
- have a spare wheel that differs from the wheel that has been changed replaced at the nearest qualified specialist workshop. You must observe the correct wheel and tire dimensions as well as the wheel type.

**!** Only use the emergency spare wheel or spare wheel of a different size briefly, and only to drive to the nearest qualified specialist workshop. You could otherwise damage the drive train.

When using an emergency spare wheel or spare wheel of a different size, you must not exceed the maximum permissible speed of 50 mph (80 km/h).

Snow chains must not be installed on emergency spare wheels or to a spare wheel of a different size.

You may install the spare wheel against the direction of rotation.

If a spare wheel is installed, the tire pressure monitor may continue to show the tire pressure of the wheel that has been removed for a few minutes. The value displayed for the position where the emergency spare wheel is installed is not the same as the current tire pressure of the spare wheel.

You should regularly check the pressure of all your tires, including the spare wheel, particularly prior to long trips, and correct the pressure as necessary (▷ page 260).

Remove the spare wheel from the spare wheel bracket (▷ page 245).

You can ask for information regarding permitted spare wheels at an authorized Mercedes-Benz Center.

### Information regarding technical data

**i** The data stated here specifically refers to a vehicle with standard equipment. Consult an authorized Mercedes-Benz Center for the data for all vehicle variants and trim levels.

## Vehicle electronics

### Installing two-way radios and mobile phones (RF transmitters)

#### **⚠ WARNING**

The electromagnetic radiation from two-way radios can interfere with the vehicle electronics if two-way radios are manipulated or retrofitted incorrectly. This could jeopardize the operating safety of the vehicle. There is a risk of an accident.

You should have all work on electrical and electronic components carried out at a qualified specialist workshop.

#### **⚠ WARNING**

If you incorrectly operate two-way radios in the vehicle, the electromagnetic radiation may interfere with the vehicle electronics, for example if:

- the two-way radio is not connected to an exterior antenna
- the exterior antenna is not correctly mounted or is not low-reflection

This could jeopardize the operating safety of the vehicle. There is a risk of an accident.

Have the low-reflection exterior antenna installed at a qualified specialist workshop. Always connect two-way radios to the low-reflection exterior antenna when operating in the vehicle.

**!** The operating permit may be invalidated if the instructions for installation and use of two-way radios are not observed.

In particular, the following conditions must be complied with:

- only approved wavebands may be used.
- observe the maximum permissible output in these wavebands.
- only approved antenna positions may be used.

Excessive levels of electromagnetic radiation may cause damage to your health and the health of others. Using an exterior antenna takes into account current scientific discussions relating to the possible health hazards that may result from electromagnetic fields.

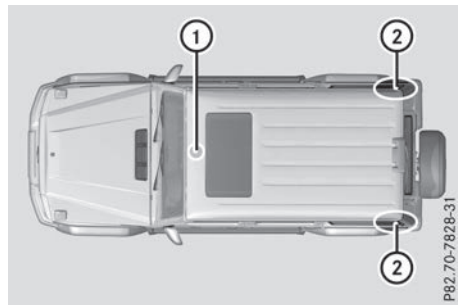

Approved antenna positions

- ① Front roof area
- ② Rear fender

When installing an antenna on the front roof area of vehicles with a sliding sunroof, observe the sweeping range of the roof.

On the rear fenders, it is recommended to position the antenna on the side of the vehicle closest to the center of the road.

Use Technical Specification ISO/TS 21609 (Road Vehicles – "EMC guidelines for installation of aftermarket radio frequency transmitting equipment") when installing wireless devices. Observe the legal requirements for accessory parts.

If your vehicle has installations for two-way radio equipment, use the power supply or antenna connections intended for use with the basic wiring. Be sure to observe the manufacturer's Supplement when installing.

Deviations with respect to frequency bands, maximum transmission outputs or antenna positions must be approved by Mercedes-Benz.

The maximum transmission output (PEAK) at the base of the antenna must not exceed the following values:

Frequency band	Maximum transmission output
Short wave 3 - 54 MHz	100 W
4 m waveband 68 - 87.5 MHz	30 W
2 m waveband 144 - 174 MHz	50 W
Trunked radio system/ Tetra 380 - 460 MHz	10 W
70 cm waveband 400 - 460 MHz	35 W
Mobile communications (2G/3G/4G)	10 W

The following can be used in the vehicle without restrictions:

- Two-way radios with a maximum transmission output of up to 100 mW
- Wireless devices with transmitter frequencies in the 380 - 410 MHz waveband and a maximum transmission output of up to 2 W (trunked radio/Tetra)
- Mobile phones (2G/3G/4G)

There is no restriction for antenna positions on the outside of the vehicle for the following frequency bands:

- Trunked radio system/Tetra
- 70 cm waveband
- 2G/3G/4G

## Identification plates

### Vehicle identification plate with vehicle identification number (VIN)



- Open the front left-hand door.  
You will see vehicle identification plate ①.

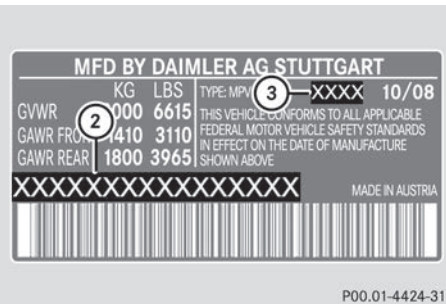

Example: vehicle identification plate (USA only)

- ② VIN
- ③ Paint code

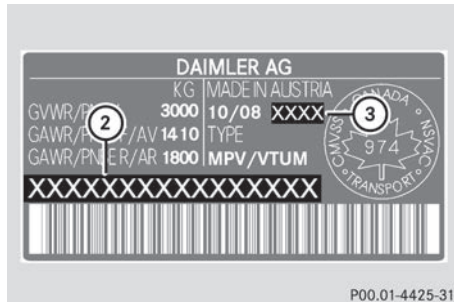

Example: vehicle identification plate (Canada only)

- ② VIN
- ③ Paint code
- ① The data shown on the vehicle identification plate is used only as an example. This data is different for every vehicle and can deviate

from the data shown here. The correct data for your vehicle can be found on the vehicle identification plate that is mounted on your vehicle.

### Vehicle identification number (VIN)

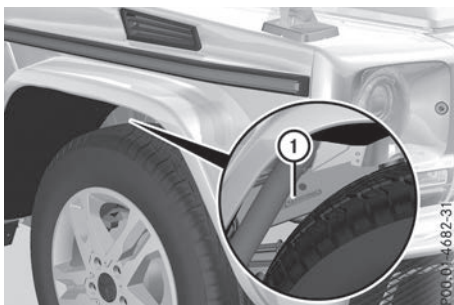

- ① VIN (stamped into the chassis on the right-hand side, when viewed in the direction of travel)

The VIN can also be found on the vehicle identification plate (▷ page 282).

The VIN can also be found at the lower edge of the windshield (▷ page 283).

### Engine number

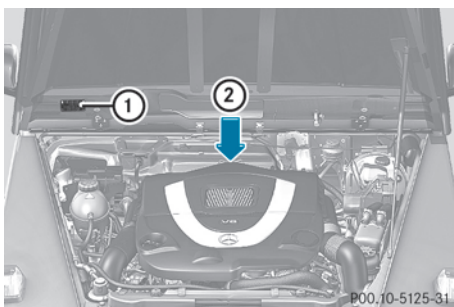

Example: engine compartment

- ① Emissions control information plate, including the certification of both federal and Californian emissions standards
- ② Engine number (stamped into the crankcase)

## Service products and filling capacities

### Important safety notes

#### WARNING

Service products may be poisonous and hazardous to health. There is a risk of injury.

Comply with instructions on the use, storage and disposal of service products on the labels of the respective original containers. Always store service products sealed in their original containers. Always keep service products out of the reach of children.

#### Environmental note

Dispose of service products in an environmentally responsible manner.

Service products include the following:

- Fuels
- Lubricants (e.g. engine oil, transmission oil)
- Coolant
- Brake fluid
- Windshield washer fluid
- Climate control system refrigerant

Components and service products must match. Only use products recommended by Mercedes-Benz. Damage which is caused by the use of products which have not been recommended is not covered by the Mercedes-Benz warranty or goodwill gestures. Products approved by Mercedes-Benz are listed in this Operator's Manual in the appropriate section.

Information on tested and approved products can be obtained at a Mercedes-Benz Service Center or on the Internet at <http://bevo.mercedes-benz.com>.

You can recognize service products approved by Mercedes-Benz by the following inscription on the containers:

- MB-Freigabe (e.g. MB-Freigabe 229.51)
- MB Approval (e.g. MB Approval 229.51)

Other designations or recommendations indicate a level of quality or a specification in accordance with an MB Sheet number (e.g. MB 229.5). They have not necessarily been approved by Mercedes-Benz.

Other identifications, for example:

- 0 W-30
- 5 W-30
- 5 W-40

## Fuel

### Important safety notes

#### WARNING

Fuel is highly flammable. If you handle fuel incorrectly, there is a risk of fire and explosion.

You must avoid fire, open flames, creating sparks and smoking. Switch off the engine and, if applicable, the auxiliary heating before refueling.

#### WARNING

Fuel is poisonous and hazardous to health. There is a risk of injury.

You must make sure that fuel does not come into contact with your skin, eyes or clothing and that it is not swallowed. Do not inhale fuel vapors. Keep fuel away from children.

If you or others come into contact with fuel, observe the following:

- Wash away fuel from skin immediately using soap and water.
- If fuel comes into contact with your eyes, immediately rinse them thoroughly with clean water. Seek medical assistance without delay.
- If fuel is swallowed, seek medical assistance without delay. Do not induce vomiting.
- Immediately change out of clothing which has come into contact with fuel.

### Tank capacity

Model	Total capacity
G 550	25.4 US gal (96.0 l)
Mercedes-AMG vehicles	29.1 US gal (110.0 l)

Model	Of which reserve
All models	Approx. 3.7 US gal (14.0 l)

### Gasoline

#### Fuel grade

 Do not use diesel to refuel vehicles with a gasoline engine. Do not switch on the ignition if you accidentally refuel with the wrong fuel. Otherwise, the fuel will enter the fuel system. Even small amounts of the wrong fuel could result in damage to the fuel system and the engine. Notify a qualified specialist workshop and have the fuel tank and fuel lines drained completely.

 Only refuel using unleaded premium grade gasoline with at least 91 AKI/95 RON.

 E10 fuel contains up to 10% bioethanol. Your vehicle is E10-compatible. You can refuel your vehicle using E10 fuel.

 Only use the fuel recommended. Operating the vehicle with other fuels can lead to damage to the fuel system, engine and exhaust system.

 Do not use the following:

- Gasoline with more than 10% ethanol
- E100 (100% ethanol)
- Gasoline with methanol
- M100 (100% methanol)
- Gasoline with metalliferous additives
- Diesel

Do not mix such fuels with the fuel recommended for your vehicle.

**!** To ensure the longevity and full performance of the engine, only premium-grade unleaded gasoline must be used.

If standard unleaded gasoline is unavailable and you have to refuel with unleaded gasoline of a lower grade, observe the following precautions:

- Only fill the fuel tank to half full with regular unleaded gasoline and fill the rest with premium-grade unleaded gasoline as soon as possible.
- Do not drive at the maximum speed.
- Avoid sudden acceleration and engine speeds over 3,000 rpm.

You will usually find information about the fuel grade on the pump. If you cannot find the label on the pump, ask the staff for assistance.

**i** For further information, consult a qualified specialist workshop or visit <http://www.mbusa.com> (USA only).

As a temporary measure, if the recommended fuel is not available, you may also use regular unleaded gasoline with an octane rating of 87 AKI/91 RON. This may reduce engine performance and increase fuel consumption. Avoid driving at full throttle and sudden acceleration. Never refuel using gasoline with a lower AKI.

Information on refueling (▷ page 120).

### Additives

**!** Operating the engine with fuel additives added later can lead to engine failure. Do not mix fuel additives with fuel. This does not include additives for the removal and prevention of residue buildup. Gasoline must only be mixed with additives recommended by Mercedes-Benz. Comply with the instructions for use on the product label. More information about recommended additives can be obtained from any authorized Mercedes-Benz Center.

Mercedes-Benz recommends that you use branded fuels that have additives.

The fuel quality available in some countries may not be sufficient. Residue could build up in the fuel injection system as a result. In such cases, and in consultation with an authorized Mercedes-Benz Center, the fuel may be mixed with the cleaning additive recommended by Mercedes-Benz. You must observe the notes and mixing ratios specified on the container.

## Engine oil

### General notes



**!** Do not use engine oil or an oil filter with specifications deviating from those expressly required for the prescribed service intervals. Do not change the engine oil or oil filter in order to set replacement intervals longer than those prescribed. This could otherwise cause damage to the engine or exhaust gas aftertreatment.

Follow the instructions on the service interval display for changing the engine oil. This could otherwise cause damage to the engine or exhaust gas aftertreatment.

When handling engine oil, observe the important safety notes on service products (▷ page 283). The engine oils are matched to the performance of Mercedes-Benz engines and service intervals. For this reason, only use engine oils and oil filters that are approved for vehicles with a service system.

Consult an authorized Mercedes-Benz Center or visit the <http://bevo.mercedes-benz.com> page (USA only) to view a list of approved engine oils and oil filters.

The table shows which engine oils have been approved for your vehicle.

Model	MB-Freigabe or MB-Approval
All models	229.5

**i** The MB-Freigabe or MB Approval is stated on the oil containers.

### Filling capacities

The following values refer to an oil change including the oil filter.

Model	Capacity
G 550	2.4 US gal (9.0 l)
Mercedes-AMG G 63	2.4 US gal (9.0 l)
Mercedes-AMG G 65	2.77 US gal (10.5 l)

### Additives

- ❗ Do not use any additives in the engine oil. This could damage the engine.

### Brake fluid

#### WARNING

The brake fluid constantly absorbs moisture from the air. This lowers the boiling point of the brake fluid. If the boiling point of the brake fluid is too low, vapor pockets may form in the brake system when the brakes are applied hard. This would impair braking efficiency. There is a risk of an accident.

You should have the brake fluid renewed at the specified intervals.

When handling brake fluid, observe the important safety notes on service products (> page 283).

Only use brake fluid approved by Mercedes-Benz in accordance with MB-Freigabe or MB-Approval 331.0.

Information about approved brake fluid can be obtained at any qualified specialist workshop or on the Internet at <http://bevo.mercedes-benz.com>.

- ❗ Have the brake fluid regularly replaced at a qualified specialist workshop in accordance with the replacement intervals and the replacement confirmed in the service report.

### Coolant

#### Important safety notes

#### WARNING

If antifreeze comes into contact with hot components in the engine compartment, it may ignite. There is a risk of fire and injury.

Let the engine cool down before you add antifreeze. Make sure that antifreeze is not spilled next to the filler neck. Thoroughly clean the antifreeze from components before starting the engine.

- ❗ Only add coolant that has been premixed with the desired antifreeze protection. You could otherwise damage the engine.

Further information on coolants can be found in the Mercedes-Benz Specifications for Service Products, MB BeVo 310.1, e.g. on the Internet at <http://bevo.mercedes-benz.com>. Or contact a qualified specialist workshop.

- ❗ Always use a suitable coolant mixture, even in countries where high temperatures prevail. Otherwise, the engine cooling system is not sufficiently protected from corrosion and overheating.

- ❗ Have the coolant regularly replaced at a qualified specialist workshop and the replacement confirmed in the service report.

Comply with the important safety precautions for service products when handling coolant (> page 283).

The coolant is a mixture of water and antifreeze/corrosion inhibitor. It performs the following tasks:

- Anti-corrosion protection
- Antifreeze protection
- Raising the boiling point

If the coolant has antifreeze protection down to -35 °F (-37 °C), the boiling point of the coolant in the pressurized system is approximately 266 °F (130 °C).



The antifreeze/corrosion inhibitor concentration in the engine cooling system should:

- be at least 50%. This will protect the engine cooling system against freezing down to approximately -35 °F (-37 °C).
- not exceed 55% (antifreeze protection down to -49 °F [-45 °C]). Otherwise, heat will not be dissipated as effectively.

Mercedes-Benz recommends an antifreeze/corrosion inhibitor in accordance with MB Specifications for Service Products 310.1.

**i** When the vehicle is first delivered, it is filled with a coolant mixture that ensures adequate antifreeze and anti-corrosion protection.

**i** The coolant is checked at specified intervals at a qualified specialist workshop.

The engine cooling system is filled with coolant at the factory which contains antifreeze/corrosion inhibitor that ensures protection down to approximately -35 °F (-37 °C).

### Capacity

Missing values were not available at time of going to print.

Model	Capacity
G 550	Approx. 14.9 US qt (14.1 l)
G 63 AMG	Approx. 14.9 US qt (14.1 l)
G 65 AMG	

### Windshield/headlamp cleaning system

#### Important safety notes

##### WARNING

Windshield washer concentrate could ignite if it comes into contact with hot engine components or the exhaust system. There is a risk of fire and injury.

Make sure that no windshield washer concentrate is spilled next to the filler neck.

**!** Do not add distilled or de-ionized water to the washer fluid container. Otherwise, the level sensor may be damaged.

**!** Only MB SummerFit and MB WinterFit washer fluid should be mixed together. The spray nozzles may otherwise become blocked.

Do not use distilled or de-ionized water. Otherwise, the level sensor may give a false reading.

When handling washer fluid, observe the important safety notes on service products (▷ page 283).

At temperatures above freezing:

- ▶ Fill the washer fluid reservoir with a mixture of water and windshield washer fluid, e.g. MB SummerFit.

Add 1 part MB SummerFit to 100 parts water.

At temperatures below freezing:

- ▶ Fill the washer fluid reservoir with a mixture of water and washer fluid, e.g. MB WinterFit.

For the correct mixing ratio refer to the information on the antifreeze reservoir.

**i** Add windshield washer fluid, e.g. MB SummerFit or MB WinterFit, to the washer fluid all year round.

### Climate control system refrigerant

#### Important safety notes

The climate control system of your vehicle is filled with refrigerant R-134a.

The instruction label regarding the refrigerant type used can be found on the radiator cross member.

**!** Only the refrigerant R-134a and the PAG oil approved by Mercedes-Benz may be used. The approved PAG oil may not be mixed with any other PAG oil that is not approved for R-134a refrigerant. Otherwise, the climate control system may be damaged.

Service work, such as refilling with refrigerant or replacing component parts, may only be carried out by a qualified specialist workshop. All applicable regulations must be adhered to, SAE standard J639 included.

Always have work on the climate control system carried out at a qualified specialist workshop.

### Refrigerant instruction label

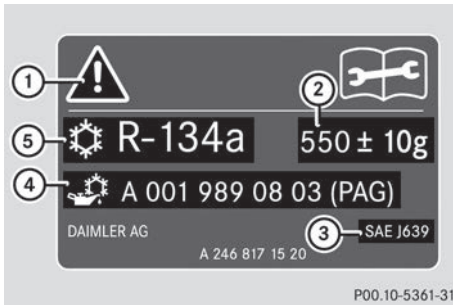

Example: refrigerant instruction label

- ① Warning symbol
- ② Refrigerant filling capacity
- ③ Applicable standards
- ④ PAG oil part number
- ⑤ Type of refrigerant

Warning symbol ① advises you about:

- Possible dangers
- Having service work carried out at a qualified specialist workshop

### Filling capacities

Missing values were not available at time of going to print.

Model	Refrigerant
<b>Mercedes-AMG vehicles</b>	
G 550	
Model	PAG oil
<b>Mercedes-AMG vehicles</b>	
G 550	

### Vehicle data

#### General notes

Please note that for the specified vehicle data:

- The heights specified may vary as a result of:
  - Tires
  - Load
  - Condition of the suspension
  - Optional equipment
- The vehicle length specified includes the front license plate adapter.

### Dimensions and weights

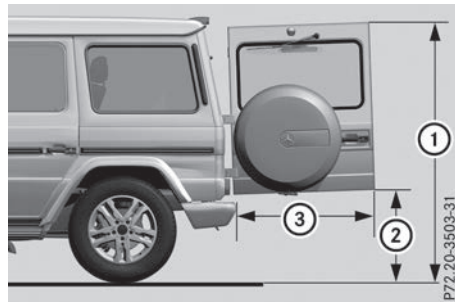

Missing values were not available at time of going to print.

	G 550
① <b>Distance to top edge</b>	75 in - 78.9 in (1905 mm - 2005 mm)
② <b>Distance to lower edge</b>	26.8 in - 30.7 in (680 mm - 780 mm)
③ <b>Range of movement</b>	36.7 in (931 mm)

	Mercedes-AMG G 63
① Upper-edge clearance	74.5 in - 78.4 in (1892 mm - 1992 mm)
② Lower-edge clearance	26.3 in - 30.2 in (667 mm - 767 mm)
③ Range of movement	36.7 in (931 mm)

	Mercedes-AMG G 65
① Distance to top edge	
② Distance to lower edge	
③ Range of movement	

Missing values were not available at time of going to print.

G 550	
Vehicle length	187.6 in (4764 mm)
Vehicle width including exterior mirrors	80.9 in (2056 mm)
Vehicle height	76.9 in (1954 mm)
Wheelbase	112.2 in (2850 mm)
Minimum ground clearance	9.3 in (235 mm)
Maximum roof load	331 lb (150 kg)
Turning radius	44.6 ft (13.60 m)
Gross vehicle weight rating (GVWR)	7054.8 lb (3200 kg)
Gross axle weight rating (GAWR), front	3417.1 lb (1550 kg)
Gross axle weight rating (GAWR), rear	4188.7 lb (1900 kg)

Mercedes-AMG G 63	
Vehicle length	187.8 in (4769 mm)
Vehicle width including exterior mirrors	80.9 in (2056 mm)
Vehicle height	76.3 in (1938 mm)
Wheelbase	112.2 in (2850 mm)
Minimum ground clearance	
Maximum roof load	330 lb (150 kg)
Turning radius	44.6 ft (13.60 m)
Gross vehicle weight rating (GVWR)	7054.8 lb (3200 kg)
Gross axle weight rating (GAWR), front	3417.1 lb (1550 kg)
Gross axle weight rating (GAWR), rear	4122.6 lb (1870 kg)

Mercedes-AMG G 65	
Vehicle length	187.8 in (4769 mm)
Vehicle width including exterior mirrors	80.9 in (2056 mm)
Vehicle height	76.3 in (1938 mm)
Wheelbase	112.2 in (2850 mm)
Minimum ground clearance	
Maximum roof load	
Turning radius	44.6 ft (13.60 m)
Gross vehicle weight rating (GVWR)	

**Mercedes-AMG G 65****Gross axle weight rating (GAWR), front****Gross axle weight rating (GAWR), rear**

- i** Gross vehicle weight (GVW) is the vehicle weight including fuel, service products, spare wheel, accessories installed, load and, if applicable, trailer drawbar load. The GVW must never exceed the GVWR.
- i** The GAWR is the maximum permissible axle weight.

**Vehicle data for off-road driving****Fording depth**

- !** The depth of water must not exceed the value specified in the table. Note that the possible fording depth is less in flowing water.



The table shows fording depth ① when loaded and ready to drive.

Missing values were not available at time of going to print.

Model	Fording depth
<b>Mercedes-AMG G 63</b>	23.6 in (60 cm)
<b>Mercedes-AMG G 65</b>	
<b>All models</b>	23.6 in (60 cm)

For more information about off-road fording, see (> page 128).

**Approach/departure angle****⚠ WARNING**

If you drive on a steep incline at an angle or turn when driving on an incline, the vehicle could slip sideways, tip and rollover. There is a risk of an accident.

Always drive on a steep incline in the line of fall (straight up or down) and do not turn the vehicle.

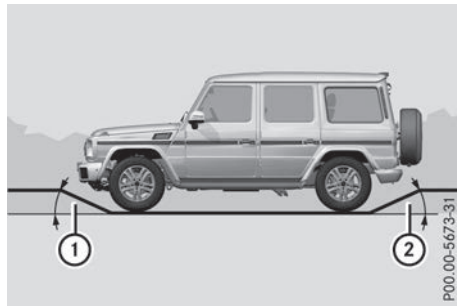

For vehicles with steel springs, loaded and ready to drive means: a full tank, all fluids refilled and the driver is in the vehicle.

Missing values were not available at time of going to print.

	①	②
<b>Mercedes-AMG G 63</b>	30°	30°
<b>Mercedes-AMG G 65</b>	27°	27°
<b>All other models</b>	30°	30°

For further information about approach/departure angles, see (> page 132).

**Maximum gradient-climbing capability**

Note that the vehicle's gradient-climbing capability depends on the off-road conditions and the road surface conditions.

On good road surfaces the maximum gradient-climbing capability of your vehicle is 100%,

which corresponds to an approach/departure angle of 45°.

Accelerate carefully and make sure that the wheels do not spin when driving on steep terrain.

- i** If the load on the front axle is reduced when pulling away on a steep uphill slope, the front wheels have a tendency to spin. 4ETS detects this and brakes the wheels accordingly. The rear wheel torque is increased, making it easier to drive off.

For further information about the maximum gradient climbing ability, see (▷ page 132).

### Trailer tow hitch

#### Permissible trailer load, braked (at a minimum gradient-climbing capability of 12% from a standstill)

Missing values were not available at time of going to print.

Model	
Mercedes-AMG G 65	
All other models	7716 lbs (3500 kg)

#### Maximum drawbar noseweight

- !** Use a drawbar noseweight as close as possible to the maximum permissible noseweight. Do not use a noseweight of less than 50 kg, otherwise the trailer may come loose.

Note that the payload and the rear axle load are reduced by the actual payload.

The drawbar load reduces the permissible overall load and rear axle load.

The drawbar load acts from above onto the ball head on the trailer tow hitch.

The drawbar noseweight is not included in the trailer load.

Missing values were not available at time of going to print.

Model	Permissible noseweight
Mercedes-AMG G 65	
All other models	308.6 lbs (140 kg)

The actual noseweight may not be higher than the value which is given. The value can be found on the trailer tow hitch or trailer identification plates. The lowest weight applies.

The maximum permissible trailer drawbar noseweight is the maximum weight with which the trailer drawbar can be loaded. The permissible trailer drawbar noseweight is the limit for Mercedes-Benz-approved trailer couplings.

#### Ball position

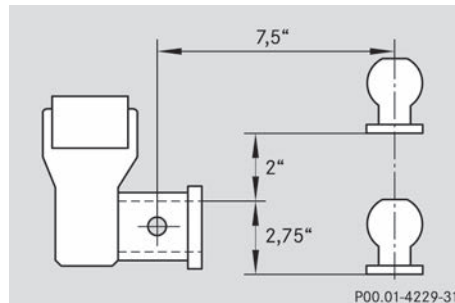

Ball position of the ball coupling

When choosing a ball coupling, the dimensions stated in the illustration must not be exceeded.

#### Gross rear axle weight rating when towing a trailer

Missing values were not available at time of going to print.

Model	Gross axle weight rating
Mercedes-AMG G 65	
All other models	4189 lbs (1900 kg)

